

Dishwasher Components

Model	Wash Cycles							Additional Features					
	Heavy Wash	Auto Wash	Normal Wash	Delicate Wash	Express Wash	Half Load	Rinse & Hold	Adjustable Upper Rack	Child Lock	Delay Start	Flip Tines	Sanitize Option	Silverware Basket
SHE3AR7#UC* SHE3ARB#UC*	X	X	X	X	X	X		X	X	X	X	X	Long
SHE3ARF#UC*	X	X	X	X	X		X	X	X	X	X	X	Double-Flex™
SHX3AR7#UC*	X	X	X	X	X	X		X		X	X	X	Double-Flex™

* “#” can be any number

SHE3AR7#UC*/SHE3ARB#UC*

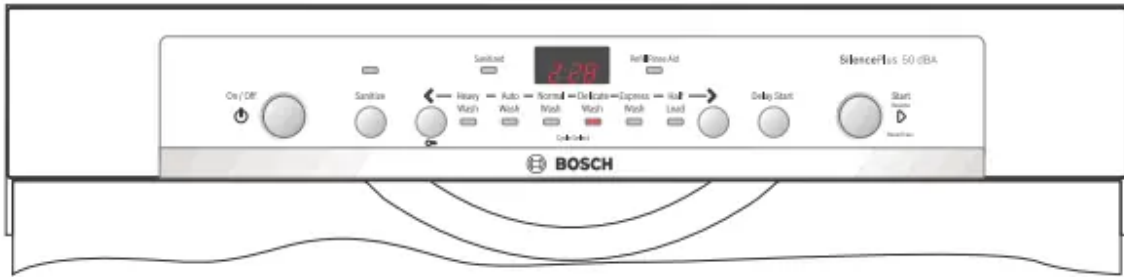

SHE3ARF#UC*

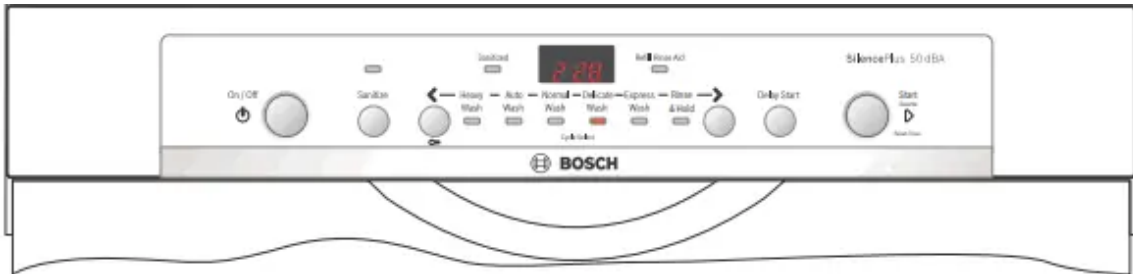

SHX3AR7#UC*

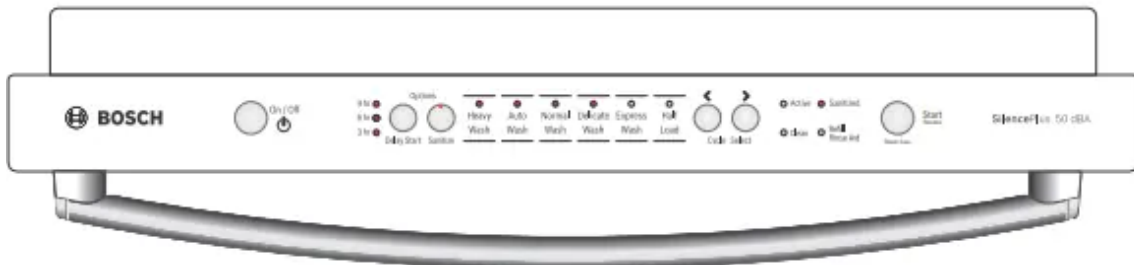

* “#” can be any number



Dishwasher Features

Self-Latching Door: The self-latching feature will hold the door wherever you place it and then automatically latch when open 20 degrees or less.

Delay Start: Delays the start time of your dishwasher by 3, 6, or 9 hours.

EcoSense Wash Management System: Checks water condition and decides if a second fresh water fill is necessary.

Extra Dry Heat: Raises the temperature of the rinse and increases the drying time resulting in improved drying.

Flow-Through Heater™: Quickly and efficiently heats water to a sanitizing temperature.

Noise Reduction System: Uses Suspension Motor™, a two-pump motor system, and insulation to make this dishwasher part of the quietest dishwasher line in North America.

Nylon Coated Racks: Eliminates cuts and nicks and have a five year warranty.

OptiDry®: This feature senses when the unit is low on rinse agent and automatically increases the drying time.

Sanitize: An option to meet sanitized conditions and improve drying results. This option can only be used with certain wash cycles. See page 12.

Triple Filtration System: Uses multiple filters to ensure distribution of clean water and protect the main pump and the drain pump from foreign material.

Model dependent features:

Adjustable Rack: The upper rack can be raised or lowered manually to accommodate tall items in the upper and lower racks.

Flip Tines: Increase the rack flexibility to accommodate larger/taller items.

Dishware Materials

NOTE: Before using your dishwasher for the first time, check the information in this section. Some items are not dishwasher safe and should be hand washed; others require special loading.

Recommended:

Aluminum: Colored anodized aluminum may fade over time. Minerals in your water may cause the aluminum to darken or spot. This can usually be removed with a soap-filled steel wool pad. China, Crystal, Stoneware: Some hand-painted utensils may discolor, fade or spot. Hand wash these utensils. Position fragile glassware so that it will not topple over or come in contact with other utensils during the wash cycle.

Glass: Milk glasses may discolor or become yellow.

Non-stick Coatings: Apply a light coating of vegetable oil to non-stick surfaces after drying.

Plastics: Make sure the plasticware is dishwasher safe.

Stainless Steel, Sterling Silver and Silver Plates: Load these so they do not come in contact with other metals.

Not Recommended:

Acrylic: Crazing or small cracks throughout the acrylic, may occur.

Adhesive-Joined Pieces: Adhesives that join materials such as plastic, wood, bone, steel copper, tin, etc. may loosen.

Bone-Handled Utensils: Handles may separate.

Iron: Iron will rust. Hand wash and dry immediately.

Non-Dishware Items: Your dishwasher is intended for use in cleaning ONLY standard household dishware and kitchenware.

Pewter, Brass, Bronze: These items will tarnish. Hand wash and dry immediately.

Tin: Tin will stain. Hand wash and dry immediately.

Wood: Wooden bowls, wooden utensils and utensils with wooden handles can crack, warp and lose their finish.

Loading the Dishwasher

Do not pre-wash items with loosely attached soiling. Remove all food particles, bones, toothpicks and excessive grease. Items having burned-on, baked-on or starchy soils may require some pretreatment. Refer to the Dishware Materials section for more information about dishware suitability. Load only dishwasher safe items into the dishwasher. Load dishes in the dishwasher racks so the insides of bowls, pots and pans are facing the spray arms. Avoid nesting and contact points between dishes. Separate items of dissimilar metals.

Loading the Upper Rack

Ensure items do not protrude through the bottom of the racks and block the spray arms.

NOTE: When pushing the upper rack into the dishwasher, push it until it stops against the back of the tub so the upper rack spray arm connects to the water supply at the back of the tub. Do not push racks in using the door.

Loading the Lower Rack

Place large items in the lower rack. Load pots, pans and bowls upside down. Do not block vent with tall baking sheets. Load these items on the left side of the dishwasher.

Unloading the Dishwasher

When unloading the dishwasher it is best to unload the lower rack first. Next, unload the silverware basket followed by the upper rack.

Suggested Loading Pattern



Additional Loading Pattern

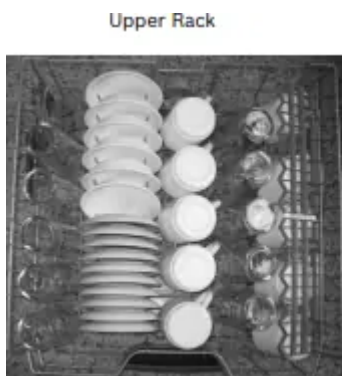

Loading the Silverware Basket

Place knives and sharp utensils with their HANDLES UP and forks and spoons with their handles down. If large or oddly-shaped items are loaded in the silverware basket, be sure they do not nest together.

The Double-Flex™ Silverware Basket (select models)

This basket splits along its length, resulting in two halves that may be placed in a variety of positions in the lower rack, greatly increasing the lower rack's loading versatility. The basket snaps together either back to back or end to end as shown.

To split the Double-Flex™ Silverware Basket

Grasp the basket and slide the two halves in opposite directions as shown at right and then pull the two halves apart.

Double-Flex™ Basket Placement Options



The Long Silverware Basket (select models)

The long silverware basket fits along the side of the lower rack.

Long Basket Placement Option

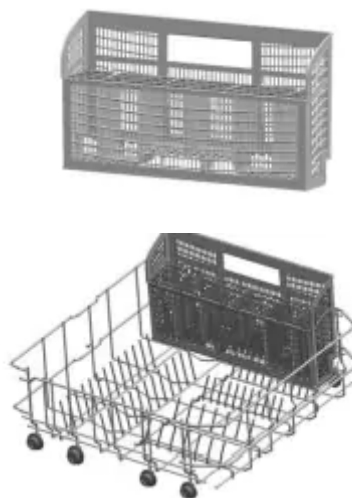

The basket lid may also be snapped to the handle in order to leave the basket open

Loading pattern for Long Silverware Basket



- 1- salad fork
- 2- teaspoon
- 3- dinner fork
- 4- knife
- 5 - tablespoon
- 6 - serving spoon
- 7 - serving fork



Loading pattern for Double-Flex™ Silverware Basket

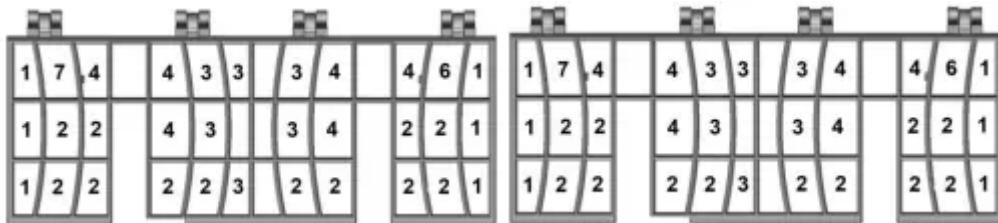

Rack Accessories

Flip Tines (model dependent)

The racks consist of tines that can be folded down depending on what you may need to load in the rack. To fold down, grasp the folding tine and release from notch. Push folding tine downward to desired position as shown in Figure 1.

Figure 1



Adjustable Upper Rack (model dependent)

Remove the empty upper rack by pulling it out of the dishwasher until it can be lifted upward as show in Figure 2. Pull the rack up and out until the rollers are completely free of the roller guides.

Figure 2



Re-insert the rack with the other set of rollers on the roller guides as shown in Figure 3.

Figure 3



Adding Detergent and Rinse Agent

Detergent

Use only detergent specifically designed for dishwashers. For best results, use fresh powdered dishwashing detergent or detergent tabs.

This dishwasher uses less water than most, therefore, less detergent is required. With soft water, 1 tablespoon (15 ml) of detergent will clean most loads. The detergent dispenser cup has lines that measure detergent to 1 tablespoon (15 ml) and 1.75 tablespoons (25 ml). 3 tablespoons (45 ml) of detergent will completely fill the detergent dispenser.

NOTE: If you do not know the hardness of your water supply, use 15ml of detergent. Increase the amount if necessary to the least amount required to get your kitchenware

clean. Use the measuring lines in the detergent dispenser cup as a guide to measure the amount of detergent recommended in Table 1 on page 11.

Adding Detergent

- 1 tablespoon (15ml) will clean most loads (see Figure 4).
- Do not use more than 3 tablespoons (45ml).
- Do not over fill the detergent dispenser.
- When using detergent tabs, lay them flat to avoid contact with the cover.

Figure 4

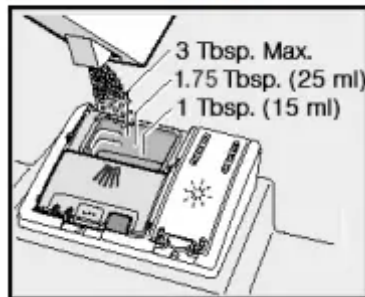

To Close

- Place finger as shown in Figure 5.
- Slide door closed and press down firmly until it clicks.

Figure 5

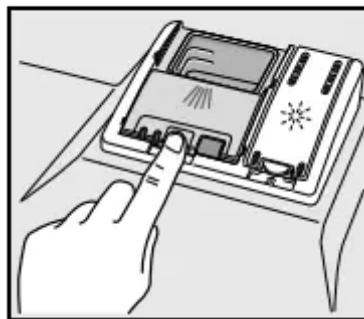

To Open

- To open the cover, push the button as shown in Figure 6.
- Cover will slide open.

Figure 6

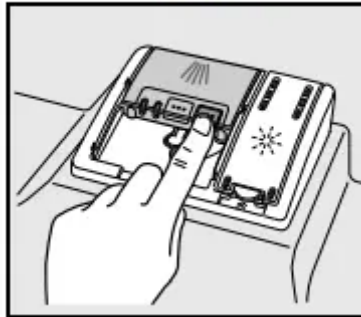

Table 1 - Recommended Detergent Amount

Table 1 - Recommended Detergent Amount

Wash Cycle	Hard Water/ Heavy Soil	Medium Water/ Medium Soil	Soft Water/ Little Soil
Heavy	3 tbsp (45 ml)	3 tbsp (45 ml)	1.75-3 tbsp (25-45 ml)
Auto	1.75-3 tbsp (25-45 ml)	1.75 tbsp (25 ml)	1-1.75 tbsp (15-25 ml)
Normal	1.75-3 tbsp (25-45 ml)	1.75 tbsp (25 ml)	1-1.75 tbsp (15-25 ml)
Delicate	1.75 tbsp (25 ml)	1-1.75 tbsp (15-25 ml)	1 tbsp (15 ml)
Express	1.75 tbsp (25 ml)	1-1.75 tbsp (15-25 ml)	1 tbsp (15 ml)
Half Load	1.75 tbsp (25 ml)	1-1.75 tbsp (15-25 ml)	1 tbsp (15 ml)
Rinse & Hold	None	None	None

Rinse Aid

To achieve proper drying, always use a liquid rinse aid, even if your detergent contains a rinse aid or drying additive.

NOTE: The dishwasher indicates low rinse aid by turning on the “Refill Rinse Aid” LED in the display. If this light is on, you need to refill the rinse aid dispenser by following the directions below.

Adding Rinse Aid

- 1 Add liquid rinse aid to the dispenser until it is full (see Figure 7). Do not overfill.
- 2 Close the lid. Lid must be fully closed until it clicks in order to seal.
- 3 Wipe up any excess rinse aid that may have puddled when the dispenser reservoir is full.

The indicator light will go out a few moments after the dishwasher door is shut. See page 14 for instructions on how to adjust the amount of rinse aid dispensed.

Figure 7

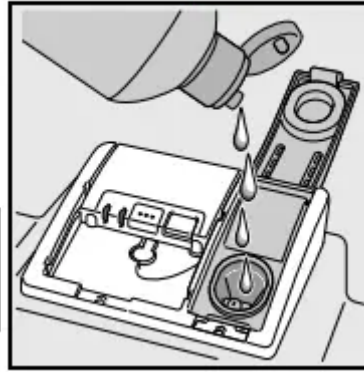

Dishwasher Cycles and Options

Wash Cycles (model dependent)

NOTE: In order to save energy, it is recommended to set the “Auto Power Off” feature to “P:01” (see manual section titled “Auto Power Off”).

Heavy Wash: Best for cleaning items with baked-on food or grease. These dishes would normally require soaking.

Auto Wash: With our most complex soil sensing capability, this cycle is perfect for use with mixed loads of dishware and varying amounts of food soil. This is the most flexible cycle and is a good choice for everyday use.

Normal: The Normal cycle is recommended for daily, regular, or typical use to completely wash a full load of normally soiled dishes. In order to obtain optimal performance with minimum energy consumption, it is recommended to disable all available features as noted at the start of this section.

NOTE 1: See footnote for additional energy test setup instructions.

Delicate Wash: For delicate or heirloom dishware and silverware or other special items. Always make sure that the items are dishwasher safe. Refer to the Dishware Materials section on page 6 of this manual for further information. Hand washing may be the best treatment for “Not Recommended” items.

Express Wash: Cleans lightly soiled dishes and reduces overall wash time. Use this cycle to clean glasses and dessert dishware that may need to be reused at the same event.

Half Load: Can reduce the energy and water consumption when washing small, lightly soiled loads that fill approximately half of the dishwasher’s capacity.

Rinse & Hold: Allows you to rinse food soil off of a partial load and hold them in the dishwasher until you are ready to run a full load.

Wash Cycle Options

Delay Start: Allows you to delay the start time of your dishwasher by 3, 6, or 9 hours.

Sanitize: The Sanitize feature is available only in the Heavy, Auto, Normal and Half Load cycles. Select one of these cycles, press the “Sanitize Option” button and then press Start to activate the Sanitation features. The sanitize LED will light when sanitation requirements are met. The technical sanitation measures may also improve the drying results.

Wash Cycle Information

Table 2 - Wash Cycle Information

	Heavy Wash	Auto Wash	Normal Wash	Delicate Wash	Express Wash	Half Load	Rinse & Hold
cycle time	110-130 min	115-130 min	130-135 min	80-85 min	30	95-115 min	12 min
cycle time with Sanitize	120-140 min	135-150 min	150-155 min	not available	not available	115-135 min	not available
water consumption	20.4-26.6 L 5.4-7 gal	13.8-23.2 L 3.6-6.1 gal	10.9-20.7 L 2.9-5.5 gal	9.9-15.1 L 2.6-4 gal	12.2 L 3.2 gal	10.5-16.3 L 2.8-4.3 gal	4.1 L 1.1 gal
wash temperature	66-71°C 151-160°F	55-66°C 130-150°F	50-55°C 122-131°F	45-50°C 113-122°F	48°C 118°F	52°C 126°F	not available
rinse temperature	72°C 162°F	68-72°C 154-162°F	67-70°C 153-158°F	62°C 144°F	55°C 131°F	68-72°C 154-162°F	incoming

Operating the Dishwasher

Start the Dishwasher

- 1 Press the On/Off button.
- 2 One of the wash cycle LEDs will be flashing. You can now select a wash cycle.
- 3 Press the Cycle Select arrow buttons to select the desired wash cycle.
- 4 Press Start to begin the cycle.

NOTE: Your dishwasher is protected against unintentional operation. If the appliance door remains open for more than 4 seconds after pressing the [Start/Resume] button, the operation will be paused. Press the [Start/Resume] button again and close the appliance door.

Delay Start

- 1 Press the On/Off button.
- 2 Select a cycle.
- 3 Press and hold the Delay Start button until the desired delay time is shown in the display window or the appropriate LED is lit (depending on model).
- 4 Press Start to begin the cycle.

NOTE: Your dishwasher is protected against unintentional operation. If the appliance door remains open for more than 4 seconds after pressing the [Start/Resume] button,

the operation will be paused. Press the [Start/Resume] button again and close the appliance door.

Cancel a Cycle

- 1 Press and hold Start for 3 seconds.
- 2 Wait about 1 minute until the display reads "0:00" (models with display) or the "Clean" LED illuminates (models without display), indicating it is done draining.
- 3 Press the On/Off button. You may now start a new cycle.

NOTE: Your dishwasher is protected against unintentional operation. If the appliance door remains open for more than 4 seconds after pressing the [Start/Resume] button, the operation will be paused. Press the [Start/Resume] button again and close the appliance door.

Child Lock

NOTE; Only front-control models have Child Lock.

- 1 After starting a cycle you can activate the Child Lock.
- 2 Press and hold the C button until the display reads "CL" (models with display) or the "Child Lock" LED illuminates (models without display). NOTE: "CL" disappears from screen when button is released.
- 3 Child Lock is now active and buttons will not function, except On/Off.
- 4 To deactivate, press and hold the C button until the "Child Lock" LED turns off or "CL" disappears from the display.

For Models with Display

To enter options mode:

- 1 Press the On/Off button to turn the unit on.
- 2 The countdown display and one of the wash cycle LEDs will be flashing.
- 3 Press and hold down the > button, then simultaneously press and release the Start button. Now release the > button.
- 4 The "Sanitized" LED will be flashing. You are now in options mode.
- 5 Press the > button to select the option you would like to adjust.

To set amount of Rinse Aid:

NOTE: If your glasses have spots on them, you need more rinse aid. If your glasses have streaks on them, you need less rinse aid.

- 1 Follow the above instructions to enter options mode.

2 With the display showing “r:00” - “r:06” press the < button to change the amount of rinse aid dispensed.

r:00 = rinse aid is OFF

r:03 = medium amount of rinse aid dispensed

r:06 = highest amount of rinse aid dispensed

3 Press Start to save your setting.

To turn Extra Dry Heat ON or OFF:

1 Follow the above instructions to enter options mode.

2 With the display showing “d:00” or “d:01” press the < button to turn Extra Dry Heat ON or OFF.

d:00 = Extra Dry Heat is OFF

d:01 = Extra Dry Heat is ON

3 Press Start to save your setting.

Auto Power Off

NOTE: Setting can only be changed for models with a display. For models without a display, the default setting is P:00

To save energy, the dishwasher is turned off 1 minute after the wash cycle ends. This setting can be adjusted from P:00 to P:02.

To change the setting:

1 Open the door and press the [On/Off] button.

2 Hold down the “A” button (see page 17) and press [Start] until the display indicates “d:0x” (x can be any number). Release both buttons.

3 Press the “A” button until the display indicates “P:0x”.

4 Press the “C” button until the display corresponds with your requirements.

P:00 = dishwasher does not turn off automatically

P:01 = dishwasher turns off automatically after 1 minute

P:02 = dishwasher turns off automatically after 120 minutes (2 hours)

5 Press [Start] to save the setting.

For Models without Display

To enter options mode:



1 Press the On/Off button to turn the unit on. For models with the buttons on top, the door must be open. For models with the buttons on the front, the door must be closed.

2 One of the wash cycle LEDs will be flashing.

3 Press and hold down the > button, then simultaneously press and release the Start button. Now release the > button.

4 The "Clean" and one other LED (varies by model) will be flashing. You are now in options mode.

5 Press the > button to select the option you would like to adjust.

To set amount of Rinse Aid:

NOTE: If your glasses have spots on them, you need more rinse aid. If your glasses have streaks on them, you need less rinse aid.

1 Follow the above instructions to enter options mode.

2 With the "Clean" and "Rinse Aid" LEDs flashing, press the < button to change the amount of rinse aid dispensed. The "Clean" and "Rinse Aid" LEDs keep flashing and:

0 wash cycle LEDs on = rinse aid is OFF

1 wash cycle LED on = lowest amount of rinse aid dispensed

2 wash cycle LEDs on = medium amount of rinse aid dispensed

3 wash cycle LEDs on = highest amount of rinse aid dispensed

3 Press Start to save your setting.

To turn Extra Dry Heat ON or OFF:

1 Follow the above instructions to enter options mode.

2 With the "Clean" and "Sanitized" LEDs flashing, press the < button to turn Extra Dry Heat ON or OFF. The "Clean" and "Sanitized" LEDs keep flashing and:

0 wash cycle LEDs on = Extra Dry Heat is OFF

1 wash cycle LED on = Extra Dry Heat is ON

3 Press Start to save your setting

Care and Maintenance

Maintenance Tasks

Certain areas of the dishwasher require occasional maintenance. The maintenance tasks are easy to do and will ensure continued superior performance from your dishwasher.

Wiping up Spills and Splash-outs

Water may occasionally splash out of your dishwasher, particularly if you interrupt a cycle or open the dishwasher door during a cycle. To avoid floor damage and possibly mold growth, do not allow wet areas to remain around or under the dishwasher.

Clean the Stainless Steel Inner Door and Tub

Clean the outer edges of the inside door panel regularly to remove debris that may collect from normal loading. If spots begin to appear on the stainless steel, make sure the rinse agent is full and functioning properly.

Check and Clean Spray Arm Nozzles

Remove the upper spray arm by first removing the empty upper rack from the dishwasher. Turn the rack upside down. The upper spray arm is held in position by a locking nut as shown in Figure 8. Turn the locking nut counterclockwise and remove it to release the spray arm. Look for obstruction in the spray nozzles. If the spray nozzles need cleaning, flush them under running water.

Figure 8

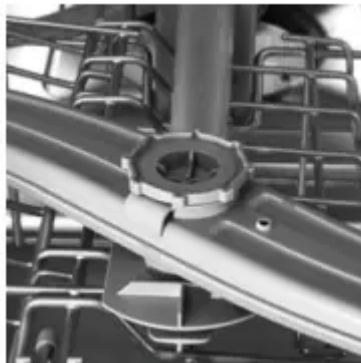

To reinstall the upper spray arm, place it back in position and return the locking nut to its install position. Turn the locking nut clockwise to secure. Return the upper rack to the upper rack roller guides. Remove the lower spray arm by first removing the empty lower rack from the dishwasher. Grasp and lift the spray arm as shown in Figure 9. Look for obstruction in the spray nozzles. If the spray nozzles need cleaning, flush them under running water. To reinstall the lower spray arm, return the lower spray arm to the installed position and press it until it snaps into place. Return the lower rack to the installed position.

Figure 9

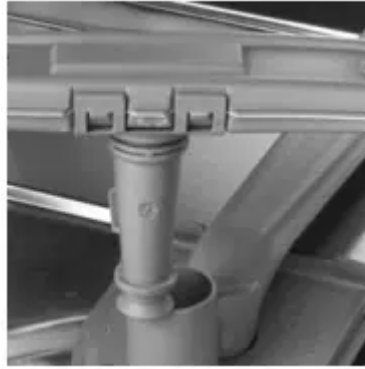

Check and Clean the Filter System

The filter system consists of a Large Object Trap, Fine Filter and a Micro Filter. The filter system is located on the inside of your dishwasher under the lower rack and is easily accessible. During normal use, the filter system is self-cleaning. You should occasionally inspect it for foreign objects and clean it when necessary

WARNING : Use caution when removing parts for cleaning as some debris may be sharp.

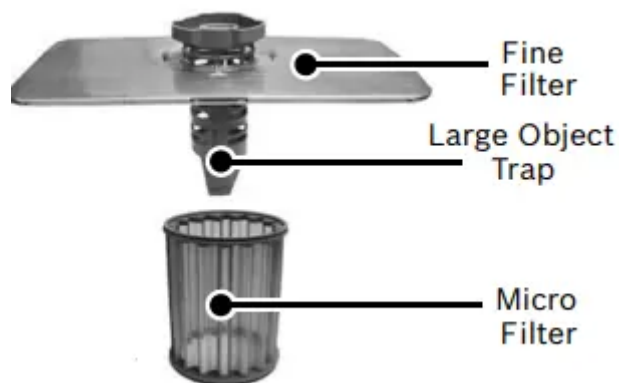

To remove the Large Object Trap, remove the lower rack. Grasp the assembly and turn it counterclockwise as shown in Figure 10. Lift the assembly out. Carefully examine the assembly. If you find debris in the Large Object Trap, turn it upside-down and gently tap it on a flat surface to dislodge and remove debris. Flush the Micro Filter clean by holding it under running water. To reinstall the filter system, return the fine filter to the installed position. Turn the locking nut clockwise until it is locked. The arrow on the ring handle and the arrow on the Fine Filter should point at each other.

Figure 10

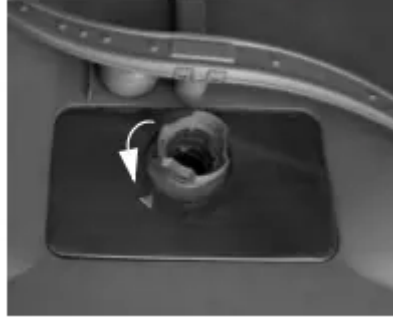

Clean the Exterior Door Panel

Colored doors: use only a soft cloth dampened with soapy water. Stainless steel doors: use a soft cloth with a non-abrasive cleaner (preferably a liquid spray) made for cleaning stainless steel. For the best results, apply the stainless steel cleaner to the cloth and then wipe the surface.

Clean the Door Gasket

Regularly clean the door gasket with a damp cloth to remove food particles and other debris. Also clean the door seal, located inside the dishwasher at the bottom of the door.

Troubleshooting



Problem	Cause	Action
Cycle does not resume after door is opened and closed during cycle.	1. Door is opened longer than 4 seconds after a cycle has started.	1. Press [START/RESUME] button again to resume cycle.
Self-latching door not closing properly	1. Self-latching feature will not work properly if dishwasher is not installed correctly	1. Ensure the alignment of the dishwasher frame is accurate and level
Dishwasher does not start	<ol style="list-style-type: none"> 1. Door may not be properly latched. 2. Unit may not be turned on. 3. Unit not reset or previous cycle not completed. 4. Delay start engaged. 5. Interruption of electrical power supply to dishwasher or blown fuse. 6. The door may have been closed without first selecting a cycle. 7. Water supply may not be turned on. 	<ol style="list-style-type: none"> 1. Shut the door completely until you hear a click. 2. Press the main power switch to turn unit on. 3. To reset, refer to “Cancel a Cycle” section of this manual. 4. To reset, refer to “Delay Start” section of this manual. 5. Check circuit breaker. 6. Select a cycle and close the door. 7. Check and turn on water supply
Display does not illuminate or console lights are not on	<ol style="list-style-type: none"> 1. A fuse may have been blown or circuit breaker tripped. 2. Door not closed or latched. <p>NOTE: For models with controls on top of the door, the display only illuminate when the door</p>	<ol style="list-style-type: none"> 1. Check the fuse or circuit breaker box and replace the fuse or reset the breaker if necessary. 2. Ensure door is properly latched and completely closed until you hear it click.



	is opened and controls are visible.	
Dishwasher seems to run a long time	<ol style="list-style-type: none"> 1. Incoming water is not warm enough. 2. Cycle time can vary due to soil and water conditions. 3. Rinse agent dispenser is empty. 4. Dishwasher connected to cold water supply. <p>NOTE: Refer to “Wash Cycle Information” section of this manual for typical cycle lengths.</p>	<ol style="list-style-type: none"> 1. Before starting a cycle, run hot water faucet at the sink closest to the dishwasher. 2. Sensors in the dishwasher automatically increase the cycle time to ensure a good wash when heavy soil is detected. 3. Add rinse agent. 4. Verify dishwasher is connected to hot water supply plumbing
Dishes are not getting clean enough	<ol style="list-style-type: none"> 1. Spray arm movement obstructed. 2. Spray arm nozzles clogged. 3. Improper use of detergents. 4. Filters could be clogged. 5. Dishes are nested or loaded too close together. 6. Selected wash cycle is not suitable for food soil conditions. 	<ol style="list-style-type: none"> 1. Ensure that spray arm movement is not blocked by hand rotating spray arms before starting cycle. 2. Remove the spray arms and clean according to the “Care and Maintenance” section of the manual. 3. Increase or decrease detergent depending on the water hardness (refer to Table 1). 4. Clean the filters according to the “Care and Maintenance” section of the manual. 5. Rearrange load such that water spray can reach all items in the dishwasher - see “Loading the Dishwasher” section of the manual. 6. Refer to “Wash Cycle Information” section of the manual.
Dishes are not getting dry enough	<ol style="list-style-type: none"> 1. Rinse agent dispenser is empty. 2. Improper loading of dishes. 	<ol style="list-style-type: none"> 1. Add rinse agent - the use of rinse agent improves drying.



	<p>3. Selected cycle does not include drying.</p> <p>4. Extra Dry Heat is not activated.</p> <p>NOTE: Plastic or Teflon do not typically dry as well as other items due to their inherent properties.</p>	<p>2. Rearrange load to ensure items are not nesting (see “Loading the Dishwasher” section of the manual).</p> <p>3. Rinse and Hold setting does not include drying.</p> <p>4. See the “Operating the Dishwasher” section of this manual to learn how to activate Extra Dry Heat.</p>
<p>Odor</p> <p>Note: Water testing is done in the factory. Occasionally water may still appear in the dishwasher at purchase which may create an odor</p>	<p>1. Food debris is present at the bottom of the dishwasher.</p> <p>2. Food particles are present near the door seal.</p> <p>3. Dishes left in unit too long before running a cycle.</p> <p>4. Residual water is present at the bottom of the dishwasher.</p> <p>5. Drain hose is obstructed.</p>	<p>1. Remove the filters and clean according to the “Care and Maintenance” section of the manual.</p> <p>2. Refer to “Care and Maintenance” section of the manual.</p> <p>3. Run a Rinse and Hold cycle if you do not intend to immediately wash the dishes.</p> <p>4. Ensure the unit has completely drained from the last cycle.</p> <p>5. Remove any obstructions from the drain hose by calling qualified personnel.</p> <p>NOTE: If odor still persists, run the Normal/Regular cycle until it flushes and interrupt the cycle and place an 8 oz. cup of distilled white vinegar solution on the upper rack and then finish the cycle.</p>
<p>Dishwasher not filling with water</p>	<p>1. Restriction in the water supply system.</p> <p>2. Previous wash cycle was not completed.</p> <p>3. Delay start is active.</p> <p>4. Household water supply turned off.</p>	<p>1. Ensure that the water supply valve (typically located under kitchen sink) is open and check that the water supply line has no kinks or clogs.</p> <p>2. Refer to the “Operating the Dishwasher” section of the manual.</p> <p>3. Cancel the delay start or wait until delay start time completes.</p> <p>4. Turn household water supply on.</p>



<p>Water leaks</p>	<ol style="list-style-type: none"> 1. Suds. 2. Door seal could be pulled away from track. 3. Condensation vent is blocked. 4. Improper installation. 	<ol style="list-style-type: none"> 1. Wrong type of detergent results in suds and leaks - use only dishwasher detergents. If suds still persist, add one tablespoon of vegetable oil at the bottom of the dishwasher and run the desired cycle. 2. Ensure the door seal is in the track. 3. Ensure that condensation vent is not blocked. 4. Have proper installation verified by qualified personnel (water supply, drain system, leveling, plumbing).
<p>Tub stains</p>	<ol style="list-style-type: none"> 1. Stains on the dishwasher interior are due to water hardness. 2. Silverware in contact with tub. 	<ol style="list-style-type: none"> 1. Concentrated lemon juice can reduce the build up of hard water stains. Run a Regular cycle until it flushes and interrupt the cycle and then place an 8 oz. cup of the concentrated lemon solution on the upper rack and finish the cycle. this can be done periodically to avoid build up. 2. Ensure that silverware does not make contact with the tub while running a cycle.
<p>Streaks on glassware or residue on the dishes</p>	<ol style="list-style-type: none"> 1. Incorrect rinse agent setting. 	<ol style="list-style-type: none"> 1. Depending on the hardness of water, adjust the rinse agent dispenser. Refer to "Operating the Dishwasher" section of the manual.
<p>Fascia panel discolored or marked</p>	<ol style="list-style-type: none"> 1. Abrasive cleaner used. 	<ol style="list-style-type: none"> 1. Use mild detergents with soft damp cloth.
<p>Noise during wash cycle</p>	<ol style="list-style-type: none"> 1. Dishes may not be arranged properly. 	<ol style="list-style-type: none"> 1. Water circulation sound is normal, but if you suspect items are banging into each other or into the spray arms, refer to the "Loading the Dishwasher" section on page 6-7 of the manual for optimal arrangement.



Detergent dispenser cover will not shut	<ol style="list-style-type: none"> 1. Improper operation of detergent cover. 2. Previous cycle has not been finished or rest or cycle or interrupted. 	<ol style="list-style-type: none"> 1. Refer to “Adding Detergent and Rinse Agent” section on page 9-10 of the manual for instructions on opening and closing the dispenser. 2. Refer to the “Operating the Dishwasher” section of the manual.
Unable to select desired cycle	<ol style="list-style-type: none"> 1. Previous cycle has not finished. 	<ol style="list-style-type: none"> 1. Refer to the “Operating the Dishwasher” section of the manual

Warning

This content is compiled from multiple sources and is provided for reference purposes only. It may not be complete or fully applicable to all situations. If you are unable to resolve your issue, please contact the product manufacturer or an authorized service provider for official support.

