

## USING YOUR AIR CONDITIONER

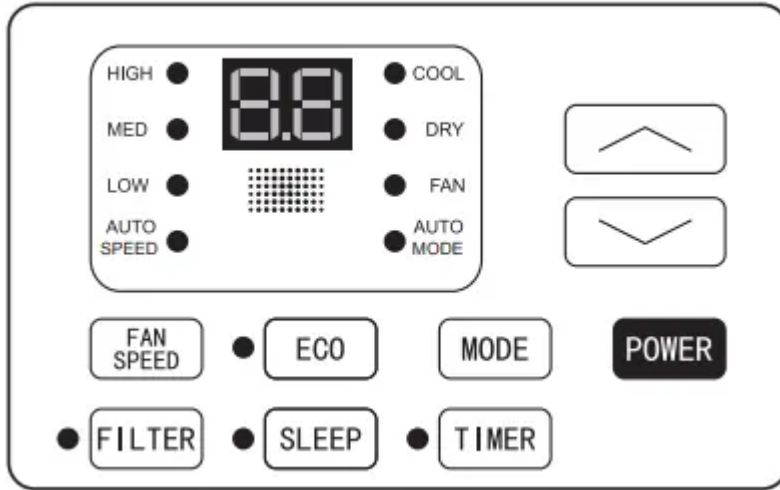

Operating your air conditioner properly helps you to obtain the best possible results.

This section explains proper air conditioner operation.

### IMPORTANT:

- If you turn off the air conditioner, wait at least 3 minutes before turning it back on. This prevents the air conditioner from blowing a fuse or tripping a circuit breaker.
- Do not try to operate your air conditioner in the Cool mode when outside temperature is below 65°F (18°C). The inside evaporator coil will freeze up, and the air conditioner will not operate properly.

**NOTE:** In the event of a power failure, your air conditioner will operate at the previous settings when the power is restored.

### Turning on the Air Conditioner

1. Press POWER to turn on air conditioner.



2. Press POWER again to turn off the air conditioner

### Selecting the Mode

1. Press MODE to cycle through modes.
2. Choose Cool, Dry, or Fan.



- Cool—Cools the room and reduces air humidity. Press MODE to activate the cooling function. Press the up or down arrow button to adjust the temperature.
- Dry Mode—Reduces the humidity of the air. Press MODE to set the Dry mode. An automatic function of alternating cooling cycles and air fan is activated.
- Fan—Only the fan runs. Press MODE to set the Fan mode. Press FAN SPEED to select High, Med, and Low. The remote control stores the speed set in the previous mode of operation. In Auto mode, the unit automatically chooses the fan speed and the mode of operation (Cool, Dry, or Fan).

**NOTE:** After 5 seconds, display will show the current room temperature.

## Features

- Eco—Conserves energy by turning off compressor when room reaches desired temperature. The fan motor will run for 10 minutes, stop for 20 seconds, then run again. The compressor will turn back on when the room temperature rises above the set temperature. Press ECO to turn Eco feature on and off. When the unit is in Eco mode, the light will turn on.

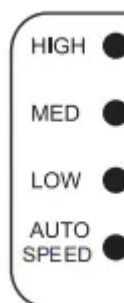

- Sleep—Automatically adjusts the temperature and fan speed to make the room more comfortable during the night. Press and hold the SLEEP button for 10 seconds until the sleep light turns on. All of the left lights will turn off. The set temperature will automatically raise by 1.8°F (1°C) every 30-60 minutes. At most, the temperature will change six times

until the temperature reaches 82°F (28°C). Running time depends upon the set temperature.

**NOTE:** After 5 seconds, display will show the current room temperature.

## Selecting the Fan Speed

1. Press FAN until the LED indicator for the desired setting is lit.
2. Choose Low, Med, or High.
  - Low—Low fan speed
  - Med—Normal fan speed
  - High—Maximum fan speed

### NOTES:

- Auto fan speed and temperature cannot be selected in Fan Only mode.
- In Eco and Sleep modes, Auto fan speed is selected automatically.
- After 5 seconds, the display will show the current room temperature.

## Adjusting the Temperature

Press the up arrow button to increase the set temperature. Press the down arrow button to decrease the set temperature.

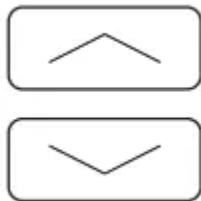

**NOTE:** After 5 seconds, the display on the air conditioner control panel will show the current room temperature.

## Using the Timer

### Delayed Shutoff:

Use the timer to set the air conditioner to turn off automatically after a 0.5- to 24-hour delay (the air conditioner must be on):

1. Press TIMER. The display will show remaining time before the air conditioner will turn off.



1. Press the up or down arrow button to change the delayed shut-off time from 0.5 to 24 hours. The time can be set in 0.5-hour increments below 10 hours and 1-hour increments for 10 hours or above.
2. Press TIMER again to confirm setting.

**NOTE:** The Set light will turn on while setting.

### **Delayed Start:**

You can also set the air conditioner to turn on automatically after a 0.5- to 24-hour delay.

**NOTE:** After the set delay, the air conditioner will turn on with the previous settings. Change the mode, fan speed, and/or temperature before setting the timer, if desired.

1. Turn off the air conditioner.
2. Press TIMER. Set the temperature by pressing the up or down arrow button.
3. Press TIMER a second time to set the rest time. Press the up or down arrow button to change the delay time from 0.5 to 24 hours, then press TIMER again.
4. Press TIMER again while the time remaining is shown on the display.

### **To Cancel Timer:**

After the timer has been set, press TIMER.

### **Changing Air Direction**

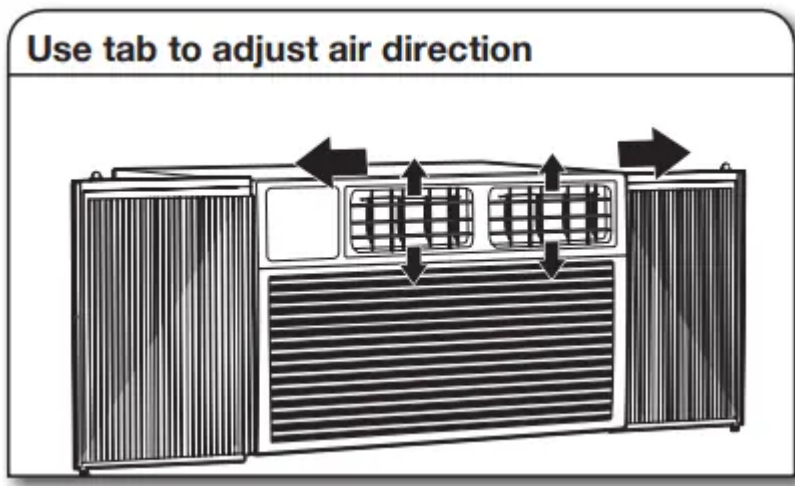

Use the thumb wheel on the vent louvers to adjust the air direction left or right.

### **Normal Operating Sounds**

When your air conditioner is operating normally, you may hear sounds such as:

- Droplets of water hitting the condenser, causing a pinging or clicking sound. The water droplets help cool the condenser.

- Air movement from the fan.
- Clicks from the thermostat cycle.
- Vibrations or noise due to poor wall or window construction.
- A high-pitched hum or pulsating noise caused by the modern high-efficiency compressor cycling on and off.
- Water will collect in the base pan during rain or days of high humidity. The water may overflow and drip from the outside part of the unit

## Clean Filter Reminder

To help maximize energy efficiency, this air conditioner features a Clear Filter reminder.



After 500 hours of operation, FILTER will illuminate as a reminder that it is time to clean the filter. Once the light is illuminated, it can be turned off by pressing the FILTER button. See the “Air Conditioner Care” section for instructions on how to clean the filter.

## Using the Remote Control

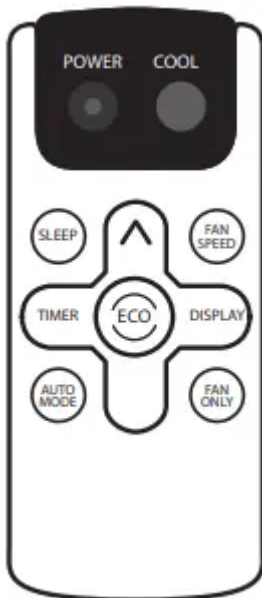

### Power

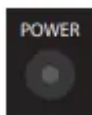

1. Press POWER to turn on air conditioner.
2. Press POWER again to turn off the air conditioner.

## Cool



Press COOL to enter Cool mode.

## Fan Speed



1. Press FAN SPEED until you see the bar LED on the air conditioner control panel display for the desired setting.
2. Choose Low, Medium, or High.

## NOTES:

1. Auto fan speed and Temperature cannot be selected in Fan mode.
2. In Energy Saver (on some models) and Cool modes, Auto fan speed is selected automatically

## Eco



- Conserves energy by turning off compressor when room reaches desired temperature. The fan motor will run for 10 minutes, stop for 20 seconds, then run again. The compressor will turn back on when the room temperature rises above the set temperature. Press ECO to turn Eco feature on and off. When the unit is in Eco mode, the light will turn on.

## Adjusting Temperature



Press the up arrow button to increase the set temperature. Press the down button to decrease the set temperature.

**NOTE:** After 5 seconds, the display on the air conditioner control panel will show the current room temperature.

### Sleep



Automatically adjusts the temperature and fan speed to make the room more comfortable during the night.

Press and hold the SLEEP button for 10 seconds until the Sleep light turns on. All of the left lights will turn off. The set temperature will automatically raise by 1.8°F (1°C) every 30-60 minutes. At most, the temperature will change six times until the temperature reaches 82°F (28°C). Running time depends upon the set temperature.

### Timer



#### Delayed Shutoff:

Use the timer to set the air conditioner to turn off automatically after a 0.5- to 24-hour delay (the air conditioner must be on):

1. Press TIMER. The display will show remaining time before the air conditioner will turn off.
2. Press the up or down arrow button to change the delayed shut-off time from 0.5 to 24 hours. The time can be set in 0.5-hour increments below 10 hours and 1-hour increments for 10 hours or above.
3. Press TIMER again to confirm setting.

**NOTE:** The Set light will turn on while setting.

#### Delayed Start:

You can also set the air conditioner to turn on automatically after a 0.5- to 24-hour delay.

**NOTE:** After the set delay, the air conditioner will turn on with the previous settings. Change the mode, fan speed, and/or temperature before setting the timer, if desired.

1. Turn off the air conditioner.
2. Press TIMER. Set the temperature by pressing the up or down arrow button.
3. Press TIMER a second time to set the rest time. Press the up or down arrow button to change the delay time from 0.5 to 24 hours, then press TIMER again.

4. Press TIMER again while the time remaining is shown on the display.

**To Cancel Timer:**

After the timer has been set, press TIMER.

**Auto:**



Press AUTO MODE to enter into Auto mode. In this mode, the fan speed and temperature are set automatically according to the room temperature as tested by the indoor temperature sensor.

**Display:**



Press DISPLAY to switch on/off all lights or the LED display

**Fan only:**



Press the Fan Only button to enter Fan Only mode.

**Replacing the battery**

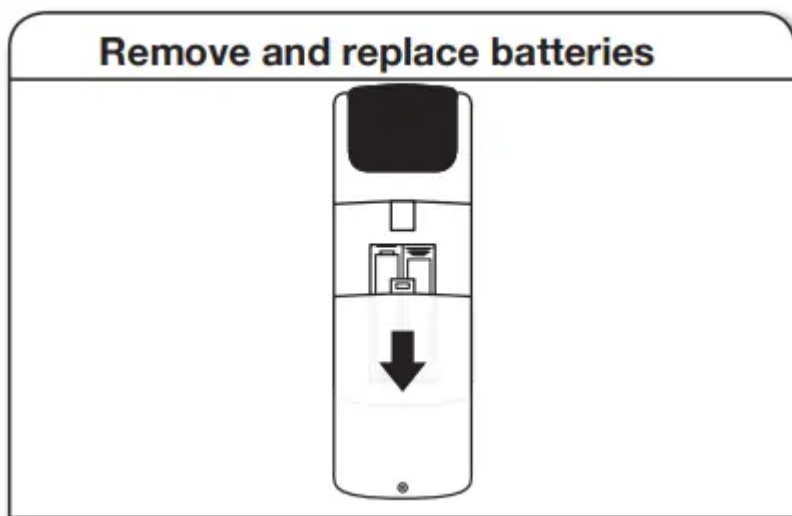

Use a small Phillips screwdriver to loosen the battery cover screw. Slide the battery cover down with two thumbs to remove. Remove and properly dispose of old batteries, then replace with two new AAA batteries. Replace the battery cover and tighten the screw.

## AIR CONDITIONER CARE

Your new air conditioner is designed to give you many years of dependable service. This section tells you how to clean and care for your air conditioner properly

### Air Filter Removal—Top Insert

On some models, the air filter is located behind the intake grille of air conditioner.

#### 1. Removing the intake grille

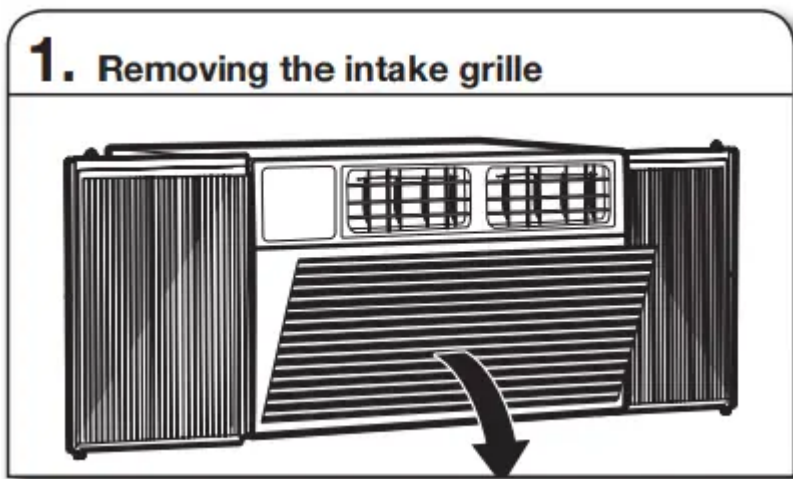

Turn off the air conditioner.

#### 2. Removing the air filter

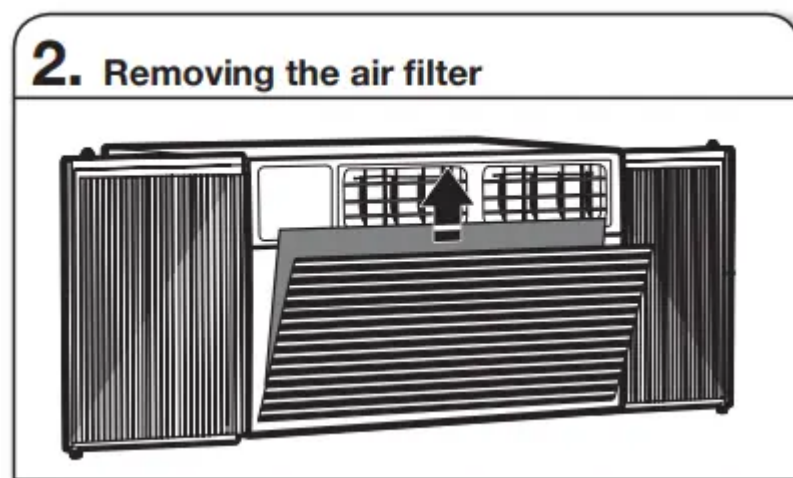

Remove the air filter by pressing down on the tabs on the air intake grille and pulling the grille away from the air conditioner.

Remove the filter from the grille by lifting to release the slotted tabs on the top and bottom of the grille.

**Reinstalling the air filter:**

1. Reattach the air filter to the air intake grille.
2. Insert the air intake grille into the slots on the air conditioner and snap into place.

**Air Filter Removal—Side Insert**

On some models, the air filter slides out the side of the intake grille.

**1. Removing the air filter**

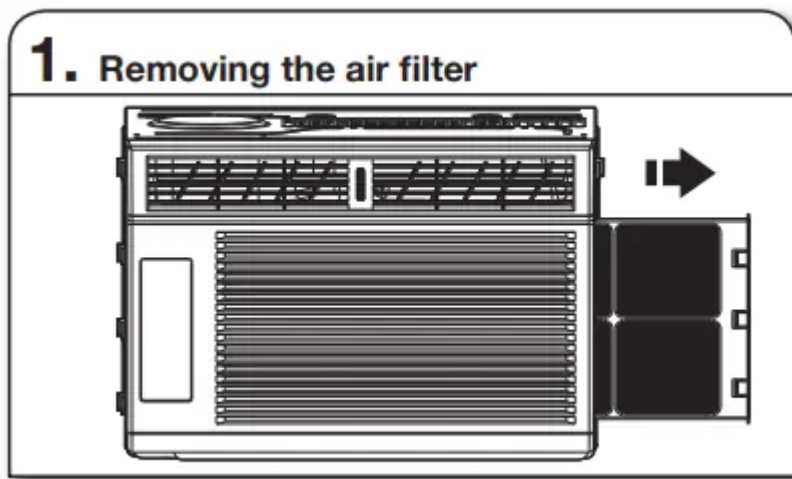

Remove the filter by grasping the tab on the filter and pulling it out of the grille to the side.

**Reinstalling the air filter:**

1. Slide the filter back into the grille

**Cleaning the Air Filter**

The air filter is removable for easy cleaning. A clean filter helps remove dust, lint, and other particles from the air and is important for best cooling and operating efficiency. Check the filter at least once per month to see whether it needs cleaning.

**NOTE:** Do not operate the air conditioner without the filter in place. Doing so will degrade the unit performance over time.

Use a vacuum cleaner to clean air filter. If the air filter is very dirty, wash it in warm water with a mild detergent.



**NOTE:** Do not wash the air filter in the dishwasher or use any chemical cleaners; it may damage the filter. Air dry the air filter completely before replacing to ensure maximum efficiency.

### **Cleaning the Front Panel**

1. Unplug the air conditioner to prevent shock or a fire hazard.
2. Wipe the front panel with a soft, damp cloth.
3. Air dry the front panel completely.

### **Repairing Paint Damage**

Check once or twice a year for paint damage. This is very important, especially in areas near saltwater or where rust is a problem. If needed, touch up with a good grade enamel paint.

### **Winter Storage**

1. Remove the air conditioner according to the installation instructions.
2. Cover the air conditioner with plastic or place it back into the original box.

## **TROUBLESHOOTING**

Before calling for service, try the suggestions below to see whether you can solve your problem without outside help

| <b>PROBLEM</b>                                     | <b>POSSIBLE CAUSES</b>                        | <b>RECOMMENDED SOLUTIONS</b>   |
|--|---|--|
| <b>The Air Conditioner Will Not Start</b>          | The air conditioner is unplugged.             | Make sure the power supply cord is plugged into a grounded 3 prong outlet.   |
|  | The fuse is blown/circuit breaker is tripped. | Check the house fuse/circuit breaker box and replace the fuse or reset the breaker.  |
|  | Power failure                                 | The unit will automatically restart when power is restored. There is a protective time delay (approximately 3 minutes) to prevent tripping of the compressor overload. The unit may not start normal cooling for 3 minutes after it is turned back on. |
|  | The power cord reset button is tripped.       | Press the reset button located on the power cord plug. If the reset button will not stay engaged, discontinue use of the air conditioner and contact a qualified service technician.   |
| <b>The Air Conditioner Is Not Cooling Properly</b> | Airflow is restricted.                        | Make sure there are no curtains, blinds, or furniture blocking the front of the air conditioner.   |
|  | The temperature control is not set correctly. | Lower the set thermostat temperature.  |
|  | The air filter is dirty. Clean the filter.    | See the "Air Conditioner Care" section   |
|  | The room is too warm.                         | Allow time for the room to cool down after turning on the air conditioner.   |
|  | Cold air is escaping.                         | Close all open doors and/or windows where warm air may be entering.  |
|  | The cooling coils are frozen.                 | See "The Air Conditioner Is Freezing Up" below   |
| <b>The Air Conditioner Is Freezing Up</b>          | Ice is blocking the airflow.                  | Turn off the unit and allow it to thaw until the ice has melted, then operate on a higher fan speed. If this continues to occur, contact customer service for additional help.   |

|  |  |  |
|--|--|--|
| <b>The Remote Control Is Not Working</b>                   | Batteries are inserted incorrectly.                          | Check that the batteries are inserted in the correct direction.  |
|  | Batteries are dead.  | Replace the batteries and dispose of them in a responsible manner.   |
| <b>Water Is Dripping From the Unit on the Outdoor Side</b> | The weather is hot and humid.                                | This is normal during periods of high humidity.<br><b>NOTE:</b> Do not drill a hole into the bottom of the metal base pan; doing so will reduce cooling performance.   |
| <b>Water Is Dripping Inside the Room</b>                   | The air conditioner is not properly leveled.                 | The air conditioner should slope slightly downward toward the outside. Level the air conditioner to provide a downward slope toward the outside to ensure proper drainage. See the “Installation Instructions” section.<br><b>NOTE:</b> Do not drill a hole into the bottom of the metal base pan; doing so will reduce cooling performance. |
| <b>Water Collects in the Base Pan</b>                      | Moisture removed from the air is collecting in the base pan. | This is normal. Water that collects in the base pan will evaporate to the outside air. This helps with the unit's cooling process.<br><b>NOTE:</b> Do not drill a hole into the bottom of the metal base pan; doing so will reduce cooling performance.  |

## ASSISTANCE OR SERVICE

Before calling for assistance or service, please check the “Troubleshooting” section. It may save you the cost of a service call. If you still need help, follow the instructions below.

When calling, please know the purchase date and the complete model and serial numbers of your appliance. This information will help us to better respond to your request.

## INSTALLATION REQUIREMENTS

### Electrical Requirements—All Models

The electrical ratings for your air conditioner are listed on the model and serial number label. The model and serial number label is located on the right-hand side of the air conditioner cabinet.

Specific electrical requirements are listed in the “Electrical Requirements” sections. Follow the requirements for the type of plug shown in these sections.

## Electrical Requirements— 115 V Models

Model BTUs – 6,000; 8,000; 10,000; 12,000; 15,000

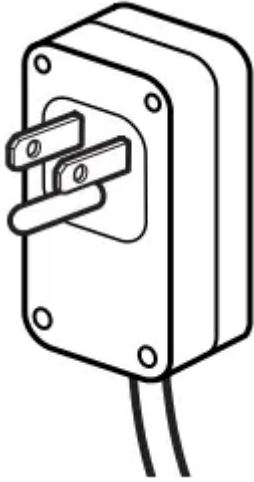

### All models –

- 115 volts – (103.5 min. - 126.5 max.)
- If there is a “Single Circuit Only” label on the unit, use on a dedicated single-outlet circuit only. If a dedicated single-outlet circuit is not available, then it is the customer’s responsibility to have a single-outlet circuit installed by a qualified electrician.
- If there is no “Single Circuit Only” label on the unit, the unit may be used on any branch circuit of correct voltage and adequate current protection rating.

### 6,000-8,000 BTU models –

- 0-8 amps
- 10-amp time-delay fuse or circuit breaker

### 10,000-15,000 BTU models –

- 0-12 amps
- 15-amp time-delay fuse or circuit breaker

## Electrical Requirements— 230 V Models

Model BTUs – 18,000; 22,000; 24,000

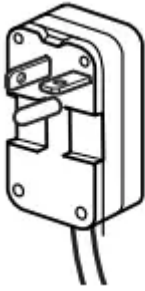

- 230 volts (208 min. - 240 max.)
- 6.6-11 amps
- 15-amp time-delay fuse or circuit breaker
- If there is a “Single Circuit Only” label on the unit, use on a dedicated single-outlet circuit only.
- If a dedicated single-outlet circuit is not available, then it is the customer’s responsibility to have a single-outlet circuit installed by a qualified electrician.
- If there is no “Single Circuit Only” label on the unit, the unit may be used on any branch circuit of correct voltage and adequate current protection rating.

### **Recommended Grounding Method**

This air conditioner must be grounded. This air conditioner is equipped with a power supply cord having a grounded 3 prong plug. To minimize possible shock hazard, the cord must be plugged into a mating, grounded 3 prong outlet, grounded in accordance with all local codes and ordinances. If a mating outlet is not available, it is the customer’s responsibility to have a properly grounded 3 prong outlet installed by a qualified electrical installer. It is the customer’s responsibility:

- To contact a qualified electrical installer.
- To assure that the electrical installation is adequate and in conformance with National Electrical Code, ANSI/NFPA 70— latest edition, and all local codes and ordinances.

### **Power Supply Cord—All Models**

**NOTE:** Your air conditioner’s power supply cord may differ from those shown.

This air conditioner is equipped with a power supply cord required by UL. This power supply cord contains state-of-the-art electronics that sense leakage current. If the cord is crushed, the electronics detect leakage current and power will be disconnected in a fraction of a second.

#### **To test your power supply cord:**

1. Plug power supply cord into a grounded 3 prong outlet.
2. Press RESET (on some models, a green light will turn on).

3. Press TEST (listen for click; Reset button will trip, and on some devices, a green light will turn off).
4. Press and release RESET (listen for click; Reset button will latch, and on some devices, a green light will turn on). The power supply cord is ready for operation.

**NOTES:**

- The Reset button must be pushed in for proper operation.
- The power supply cord must be replaced if it fails to trip when the test button is pressed or fails to reset.
- Do not use the power supply cord as an off/on switch. The power supply cord is designed as a protective device.
- A damaged power supply cord must be replaced with a new power supply cord obtained from the product manufacturer and must not be repaired.
- The power supply cord contains no user-serviceable parts. Opening the tamper-resistant case voids all warranty and performance claims.

**Tools Required—All Models**

Gather the required tools and parts before starting installation. Read and follow the instructions provided with any tools listed here.

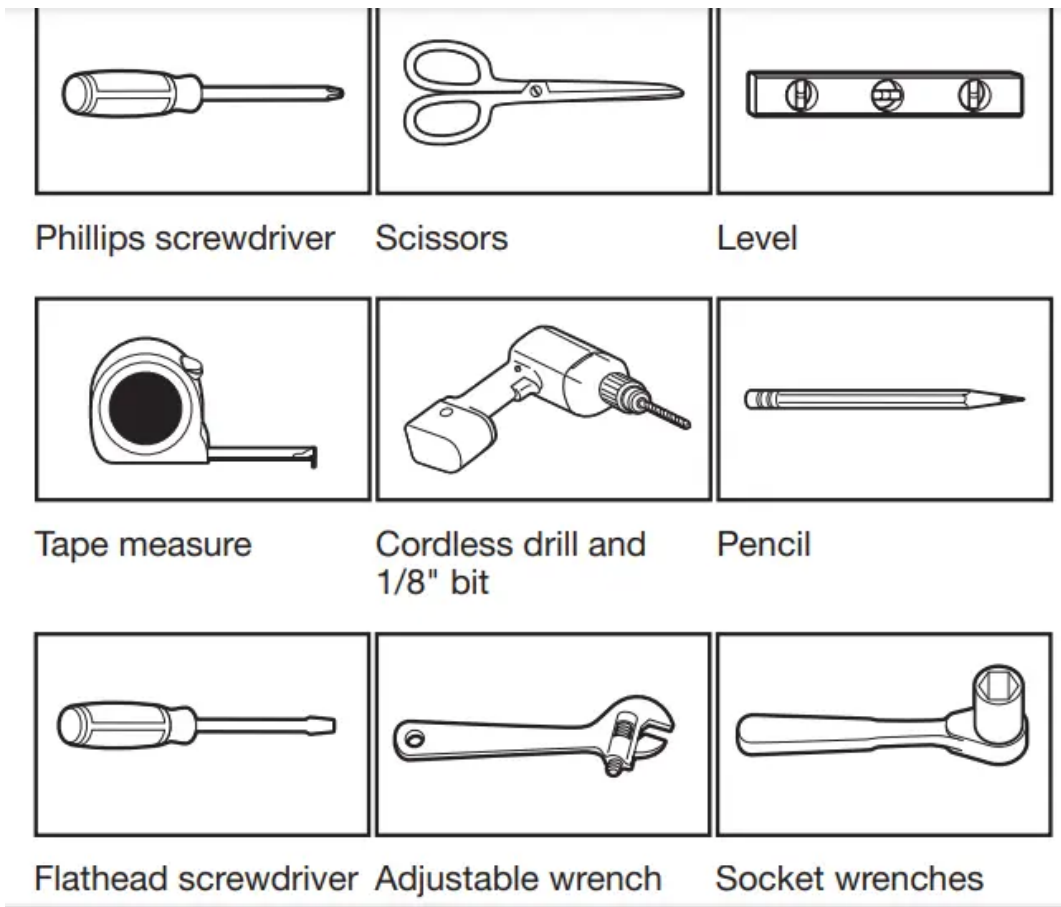

## Parts Supplied: 6,000-12,000 BTU models

Check that all parts are included in parts package.

**NOTE:** Not all parts are included with all models.

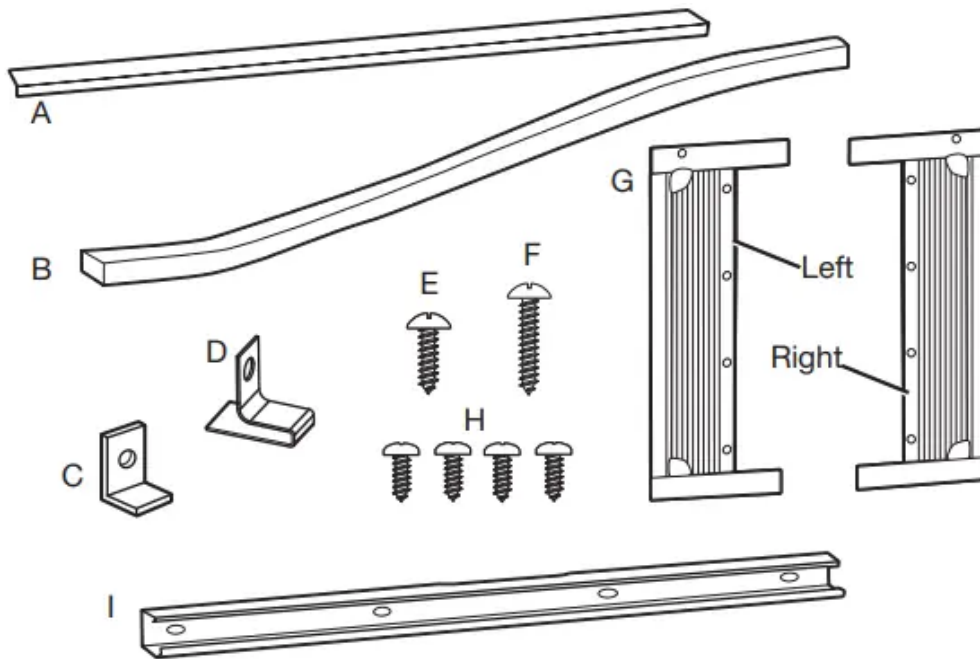

- A. Foam seal with adhesive strip
  - B. Foam seal without adhesive strip
  - C. Sash lock x1
  - D. Lock frame x2
  - E. 1/2" screws x3
  - F. 3/4" screws x4
  - G. Side curtains x2
  - H. 3/8" screws x4
  - I. Top channel (appearance may vary)
  - J. 1/2" flathead bolt with locknut x4
  - K. Gasket x2
  - L. Top channel (appearance may vary)
  - M. Window support bracket x2
  - N. Side curtains x2
  - O. Side retainers x2
- Other:** AAA batteries x2

## Location Requirements— Window Installation

**IMPORTANT:** Observe all governing codes and ordinances.

Check the location where the air conditioner will be installed. Make sure you have everything necessary for correct installation.

The location should provide:

- Grounded electrical outlet within 6 ft (183 cm) of where the power cord exits the air conditioner. Do not use an extension cord.
- Free movement of air in room to be cooled.
- A large enough opening for the air conditioner. Installation parts are supplied for double-hung windows.
- NOTE: The air conditioner can be installed without the side panels to fit in a narrow window opening.
- Adequate wall support for weight of air conditioner.
- Firm wood, masonry, or metal to secure to supporting parts.

**NOTE:** Cabinet louvers must not be obstructed. Air must be able to pass freely through the cabinet louvers.

### Window Opening Measurements

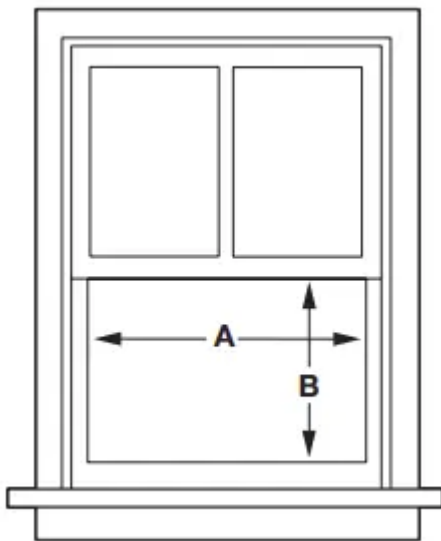

| Model BTUs    | Width (A)                     | Minimum Opening (B) |
|---------------|-------------------------------|---------------------|
| 6,000-8,000   | 23"–36"<br>(58.4 cm–91.4 cm)  | 14½"<br>(36.8 cm)   |
| 10,000-12,000 | 26"–36"<br>(66 cm–91.4 cm)    | 16"<br>(40.6 cm)    |
| 15,000-18,000 | 28"–41"<br>(71.1 cm–104.2 cm) | 19"<br>(48.3 cm)    |
| 22,000-24,000 | 30"–41"<br>(76.2 cm–104.2 cm) | 19½"<br>(49.5 cm)   |

## Prepare Window Opening

### 1. Measure and mark center line

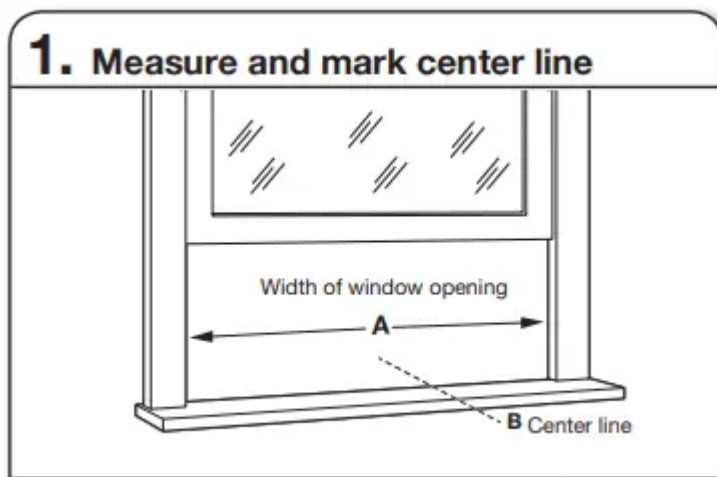

Measure the width of the window opening (A). Mark the center line (B) of the window on the inside windowsill.

### 2. Attach upper foam seal

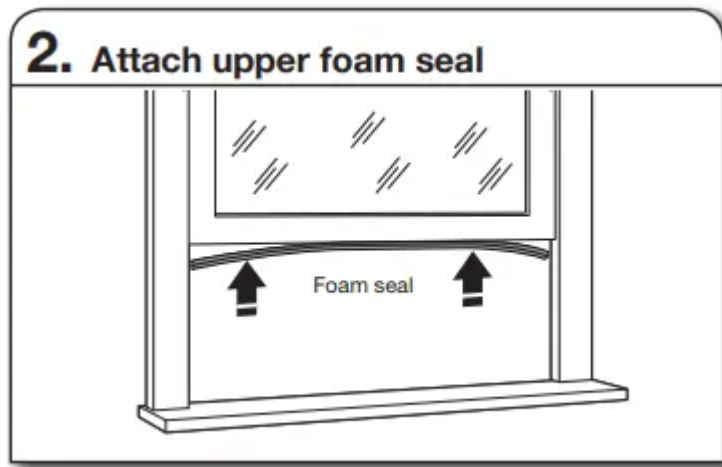

Attach the foam seal with adhesive strip to the bottom of the window sash.

### Preparing Window with Storm Window or Other Obstruction

Follow the steps in “Prepare Window Opening”. If possible, remove the storm window frame or other obstruction.

If the storm window frame or obstruction CANNOT be removed, a wood spacer will be required to ensure that the air conditioner slopes to the outside. This will allow condensation and rainwater to drain away. Make sure that drain holes or slots are not caulked or painted shut.

#### 1. Measure size of spacer needed

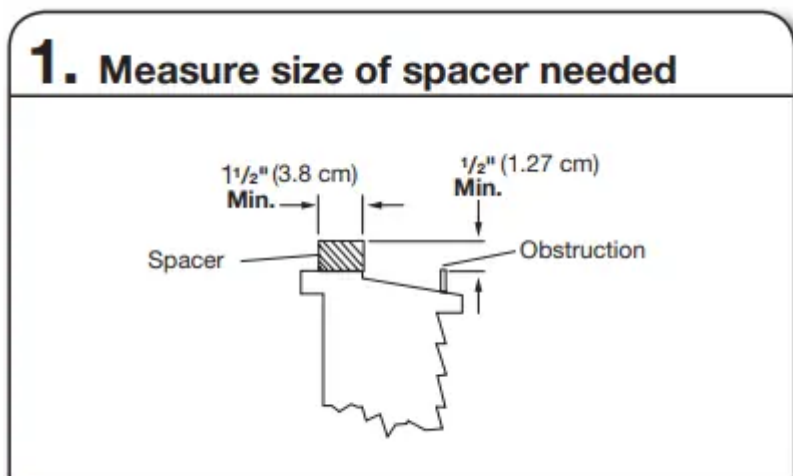

Using a level and measuring tape, determine thickness of wood spacer needed to allow the air conditioner to slope downward slightly to the outdoors. The block should provide at least 1/2" (1.27 cm) of height above the obstruction.

#### 2. Place block on windowsill

## 2. Place block on windowsill

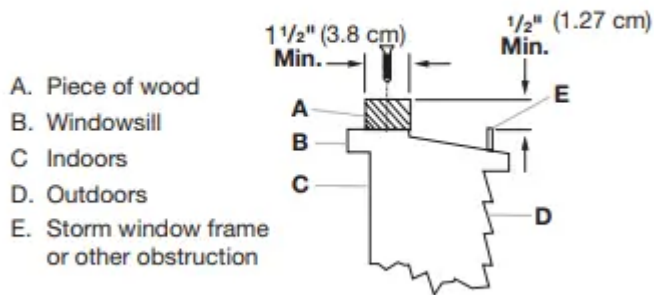

Place wood spacer on windowsill. Spacer should be at least the full width of the air conditioner cabinet.

## INSTALLATION INSTRUCTIONS—6,000-12,000 BTU MODELS

### Prepare Air Conditioner for Installation

#### 1. Unpack the Air Conditioner

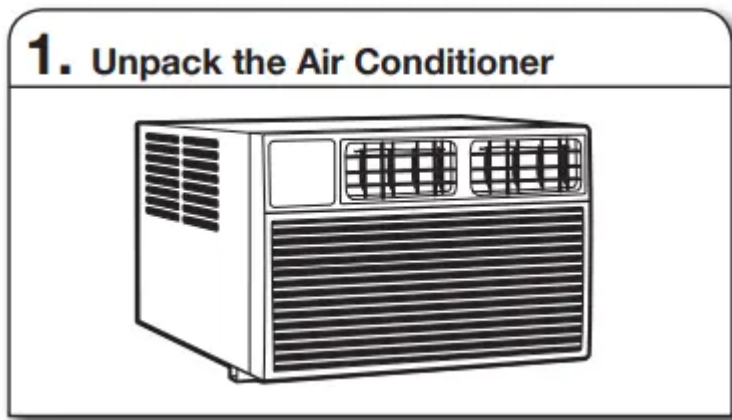

#### Remove Packaging Materials:

- Handle the air conditioner gently while unpacking the unit.
- Place the air conditioner on a hard, flat surface.
- Remove tape and glue residue from surfaces before turning on the air conditioner. Rub a small amount of liquid dish soap over the adhesive with your fingers. Wipe with a damp cloth and dry.
- Do not use sharp instruments, rubbing alcohol, flammable fluids, or abrasive cleaners to remove tape or glue. These products can damage the surface of your air conditioner.

- Remove any packaging materials inserted into the side louvers.
- Dispose of/recycle packaging materials in an appropriate way

## 2. Install top channel

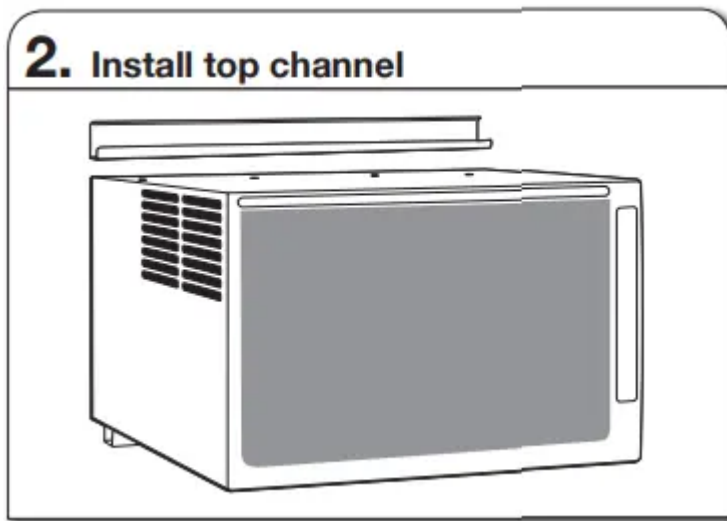

Place the top channel on the top of the air conditioner, lining up the holes in the top channel with the holes in the top of the air conditioner.

## 3. Attach screws

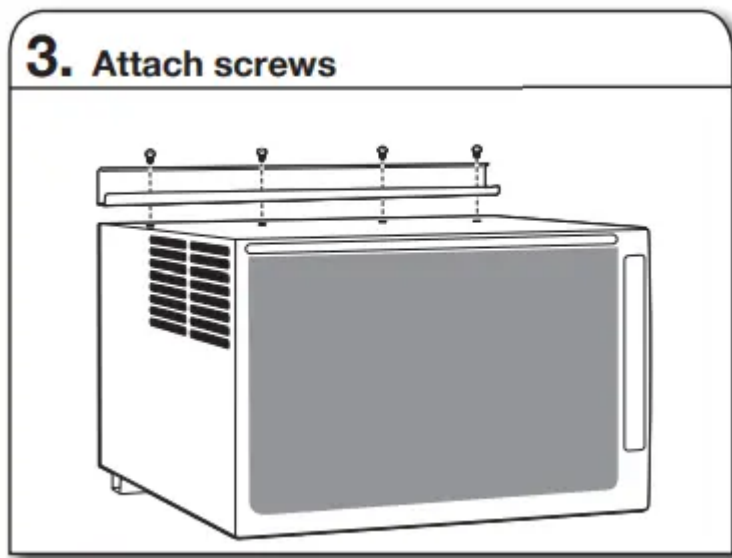

Using four 3/8" screws, attach the top channel to the air conditioner.

## Install Side Curtains

**NOTE:** Attach curtains to the air conditioner before placing the air conditioner in window.

### 1. Install side curtain

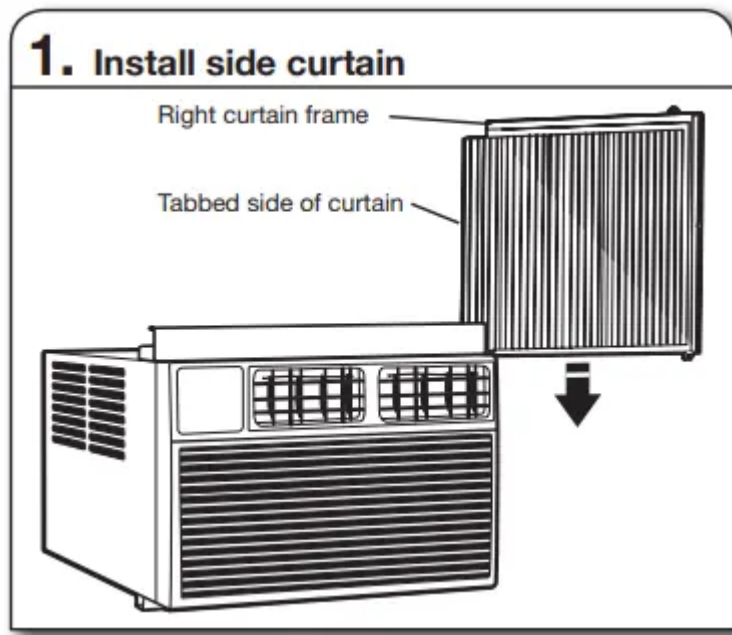

Holding the center of the right-hand side panel in one hand, pull the curtain open. Place the tabbed side of the side curtain in the track on the right-hand side of the air conditioner cabinet.

Slide the side curtain down the track, making sure to leave enough space to slip the top and bottom of the frame into the channels on the cabinet.

## 2. Insert curtain frame into channels

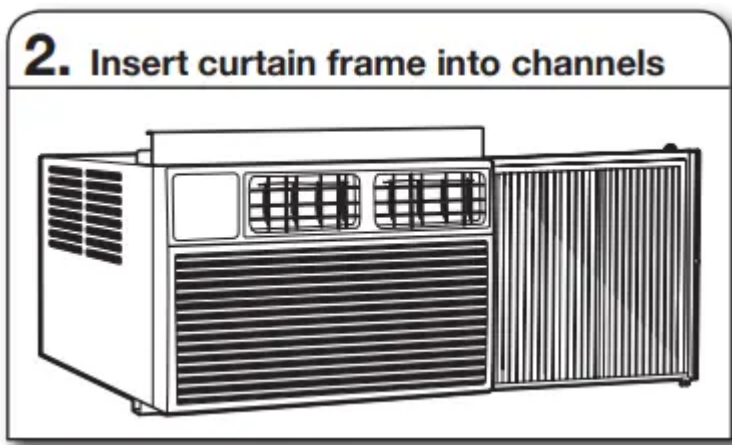

Slide the side curtain frame into the top channel and bottom channels of the air conditioner. Make slight adjustments until the panel sits securely inside the channels.

Repeat steps 1 and 2 for other side curtain and frame

## Install Air Conditioner in Window

### IMPORTANT:

- Be sure your air conditioner does not fall out of the opening during installation or removal.

- The place where the power cord exits the air conditioner should be no more than 6 ft (183 cm) from a grounded outlet
- To maximize cooling efficiency and air circulation, do not block the air intake or discharge louvers in the front panel.
- To reduce cycling on and off of the compressor and reduce the risk of freezing up or damage to the unit, do not block the louvers on the outside of the air conditioner.

### 1. Position air conditioner in window

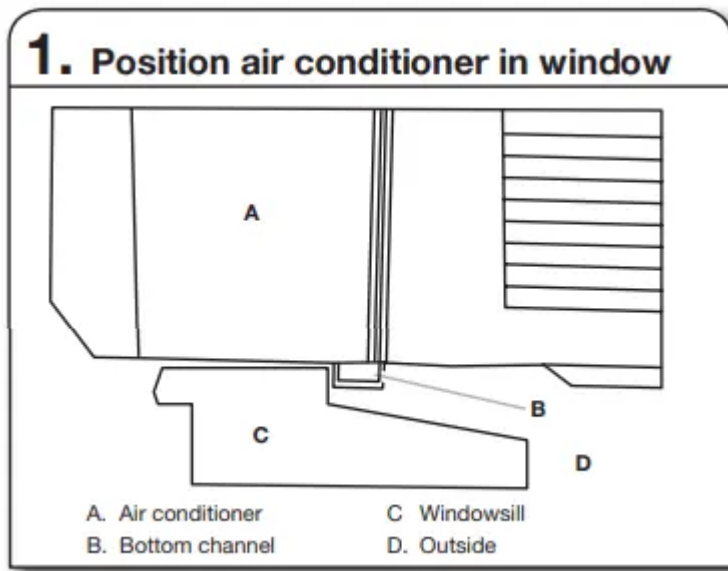

Using two or more people, place the air conditioner into the window opening so the bottom of the air conditioner frame is against the window sill. Tilt the back of the unit slightly downward to allow accumulated rain water to drain out.

### 2. Lower window sash into place

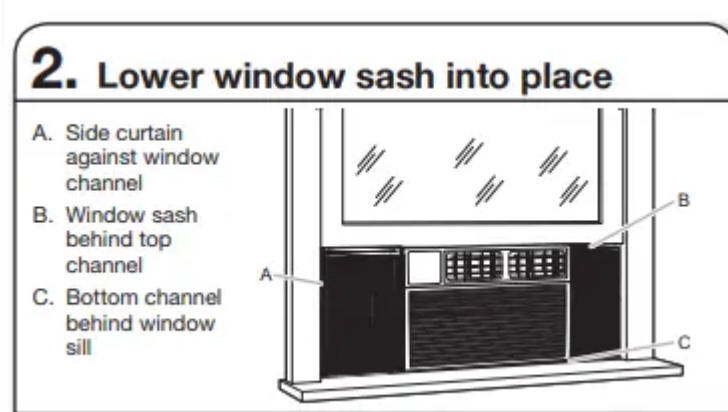

Lower the window sash behind the top channel to hold the air conditioner in place.

**NOTE:** Your model may differ from the one shown.

### 3. Extend side curtains

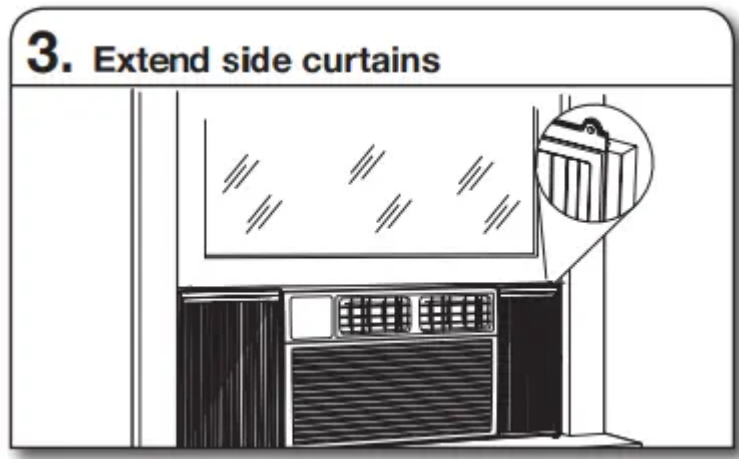

Extend side curtains out until they fit into the window channels.

#### 4. Install side curtain brackets

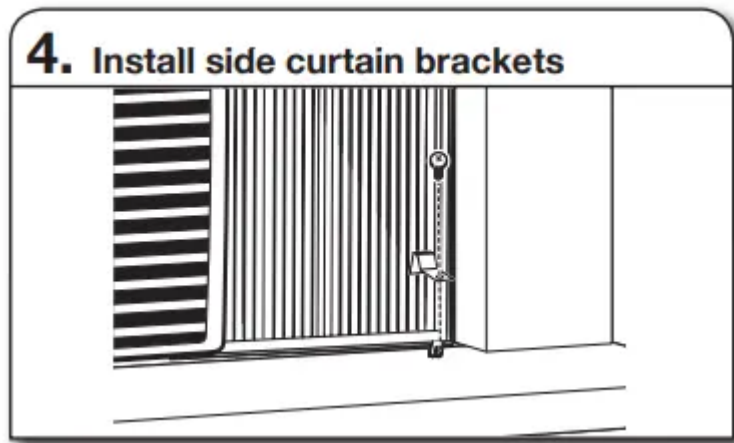

Slide a side bracket over the bottom corner of each side curtain frame.

Using a 1/8" drill bit, drill a starter hole through the hole in the side curtain bracket and into the windowsill.

Secure each bracket to the windowsill with a 3/4" screw.

#### 5. Install screws into window sash



## 5. Install screws into window sash

Use a 1/8" drill bit to drill a starter hole through the holes in the top rail and the top corners of the side curtains into the window sash.

Secure with three 1/2" screws through the holes in the top rail and side curtain and into the window sash.

## 6. Secure lower sash

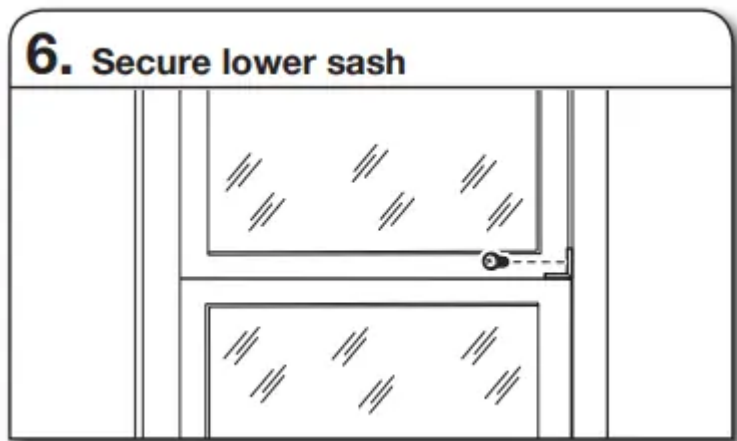

## 6. Secure lower sash

Attach the right angle sash lock with a 3/4" screw.

## 7. Install foam seal

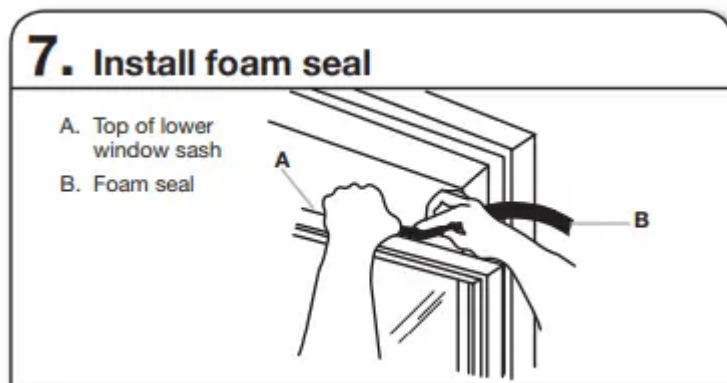

## 7. Install foam seal

- A. Top of lower window sash
- B. Foam seal

Insert the foam seal without adhesive strip between the top of the lower window sash and the glass of the upper window.

Remove any remaining clear plastic film from the control panel and plastic front panel.

**Warning**

This content is compiled from multiple sources and is provided for reference purposes only. It may not be complete or fully applicable to all situations. If you are unable to resolve your issue, please contact the product manufacturer or an authorized service provider for official support.

---

Document generated by [ManualsFile](#)

