

Your new cooker

The control panel

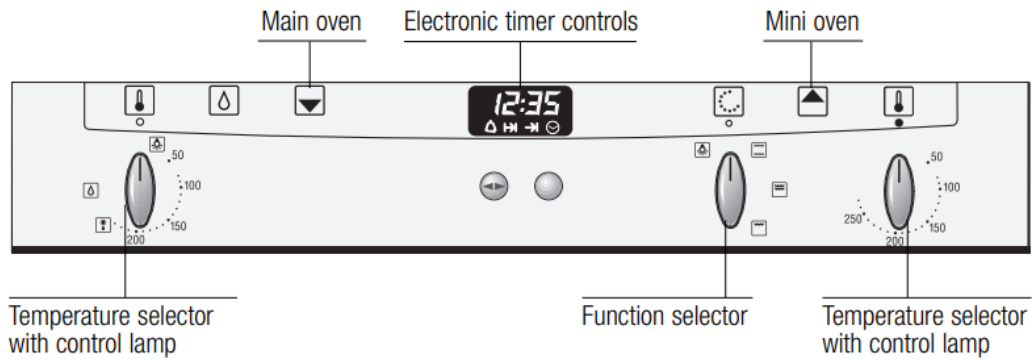

Main oven (circotherm)

Temperature selector

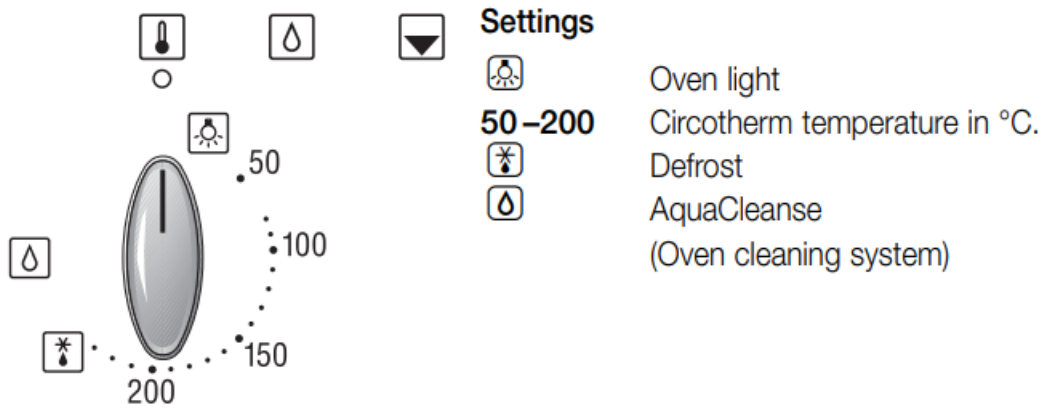

Mini oven

Temperature selector

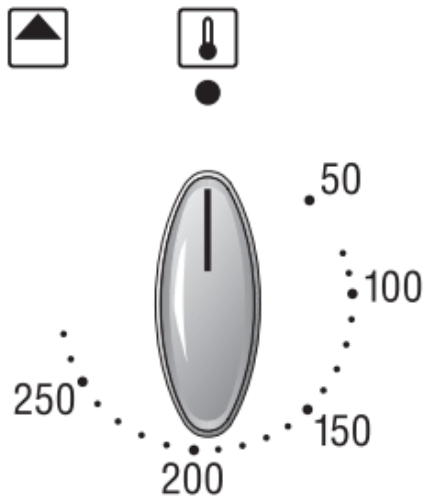

Settings



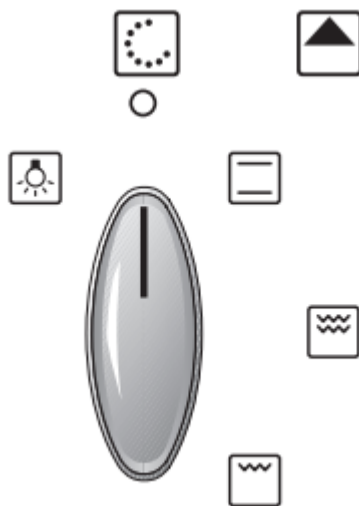

50–275 Temperature in °C.

Function selector



Use the function selector to select the type of heating for the oven.

Settings

-  Oven light
-  Top/bottom heat
(conventional heating system)
-  Large area grill
-  Small area grill

Press-down switches

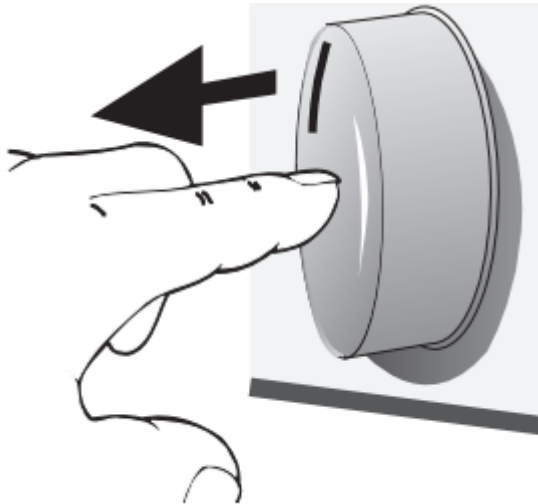

To engage and disengage, depress the switch, making sure that it is in OFF position.

Shelf positions

Mini oven

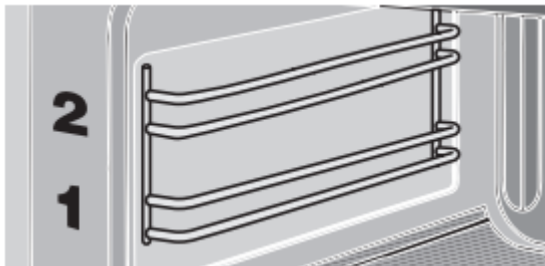

Your oven features 2 shelf positions. The shelf positions are counted from bottom to top. The numbers are marked in the oven.

Main oven



Your oven features 3 shelf positions. The shelf positions are counted from bottom to top. The numbers are marked in the oven. When using hot air function, do not use shelf position »2«, in order not to block air circulation.

Before using your appliance for the first time

Preliminary cleaning

Take the accessories out of the oven.

Remove all packaging remnants, e.g. polystyrene parts, from the oven.

1. Clean the appliance exterior with a soft moistened cloth.
2. Remove the shelf supports from the oven.
3. Clean the oven and the accessories with a hot detergent solution.

Please observe the operating instructions furnished with the hob.

Initial burn-in

Before using the appliance for the first time, you must set the time on the electronic clock.

Preheat the empty oven for about 30 minutes. Select heat for the main and mini oven at a setting of 190 °C.

Subsequent cleaning

Clean the oven with a hot detergent solution. Install the shelf supports.

Time of day

Setting the time



After connecting to the mains, or after a power failure, the display **0:00** will blink.

Press the ◀▶ button and set the current time with the rotary knob (e.g. 15:00 hours).

To correct the time, press the ◀▶ button until the symbol flashes.

Then set the time.

Note: The time cannot be corrected if an automatic function has been set (see Electronic clock for cancelling automatic function).

Electronic clock

The electronic clock can be operated with one hand; after pressing the button, set the time with the rotary knob. Settings can be made for as long as the function display flashes (~4 seconds).

The control panel





Minute timer



1. Press the  button and set the cooking time (e.g. 5 minutes).

When the timer switches on, the remaining time is displayed.

2. When the time has elapsed, a signal is emitted and the  symbol flashes. To stop the signal, press the  button.

Automatic timer for the main oven

Automatic switch off



You can switch the oven on and off via the electronic clock.

If you wish to bake or roast food immediately, it is only necessary to set the cooking time.

1. Select the heating system and the oven temperature.

2. Press the ◀▶ button until the ⇨ symbol flashes and set the cooking time with the rotary knob (example: 1 hour and 30 minutes). When the setting has been made, the current time is displayed after approx. 4 seconds. The ⇨ symbol signals automatic mode.

3. When the time has elapsed (example: 1 hour and 30 minutes), a signal is emitted and the ⇨ display flashes.

The oven switches off automatically.

To stop the signal, press the ▶◀ button.

4. Switch the oven off.

5. To end automatic mode, press the ▶◀ button again.

Automatic switch on and switch off



If the food is to be baked or roasted later on, both the cooking time and OFF time must be set.

1. Select the heating system and the oven temperature.
2. Press the ◀▶ button until the ⇨ symbol flashes and set the cooking time with the rotary knob (example: ' hour and 30 minutes).
3. Press the ◀▶ button until the →| symbol flashes and set the OFF time with the rotary knob (example: 12:30).

When the setting has been made, the current time is displayed after approx. 4 seconds.

The →| symbol signals automatic mode.



4. The oven is automatically switched on and off at the preset times (e.g. 11:00 and 12:30).
5. When the time has elapsed, a signal is emitted and the →| symbol flashes. To stop the signal, press the ◀▶ button.
6. Switch the oven off.

7. To end automatic mode, press the ◀▶ button.

Checking, correcting and cancelling settings

1. To check your settings, press the ◀▶ button until the symbol flashes.
2. If required, correct the settings with the rotary knob.
3. If you want to cancel your settings, turn the set time back to 0:00 and switch the oven off.

Note The automatic timer is best used with dishes which require little attention. The minute timer and OFF time can be preprogrammed up to a max. 24 hours. The settings can be displayed at any time by pressing the ◀▶ button.

Special functions

Masking out the display

1. Press the ◀▶ button for 7 seconds.

The display then goes blank and the time continues running in the background.

2. To switch on the display, briefly press the ◀▶ button.

Setting the time

See section "Before using your appliance for the first time".

Dimming the display

Between 22.00 and 6.00 the display is automatically dimmed.

Description of Oven Features

Main oven

Circotherm

Advantages:

- low soiling of oven interior
- cooking on up to 2 shelf levels at once is possible
- shorter preheating times
- low oven temperatures
- bread baking

Circotherm grilling

A system by which foods, that would normally be grilled by direct heat from an element, are cooked using Circotherm. Temperatures between 180 to 190 °C are selected and the food is placed on the wire shelf, roasting on the roasting/grill pan.

Advantages:

- ideal for steaks, sausages, chicken joints, fish, kebabs and chops
- no turning of food is required
- three shelves of 'grilled' food can be prepared at one time
- very convenient.

Defrost



A fan in the rear wall of the oven circulates the air in the oven around the frozen food.

The fan system is running without heating.

Advantages:

- Gentle defrosting.
- Frozen pieces of meat, poultry, bread and cakes defrost evenly.

AquaCleanse (oven cleaning system)



The oven cleaning function featured in your oven is intended to help you keep your oven neat and tidy. An amount of cleaning solution is vaporised automatically. The combined effects of heat and steam soften the soil deposits on the oven wall enamel and facilitate their removal. For more information on this function, see the section on "Cleaning and Care" later in this booklet.

Advantages:

- takes the toil out of oven cleaning
- protects the enamel on interior surfaces
- constitutes an environmentally friendly cleaning method

Mini oven

Top and bottom heat (Conventional heating system)



The food being baked or roasted is exposed to heat radiation from heating elements located at the top and bottom of the oven cavity. Baking and roasting is possible on one shelf position only.

Advantages:

– Baking of cake with wet fillings, pizza, quiche, e.g.

Surface grilling

The food being prepared is exposed to heat radiation from the heating element at the top of the oven cavity.

- Particularly effective with flat, small cuts of meat, i.e., steaks, sausages, fish, vegetables and toast.

Large area grill



Advantages:

- the entire grilling surface heats up
- especially useful with large amounts of food

Small area grill



Advantages:

- only the centre area of the grilling surface heats up
- especially useful with small amounts of food
- energy-saving operation

Switching the Oven ON and OFF

Main oven

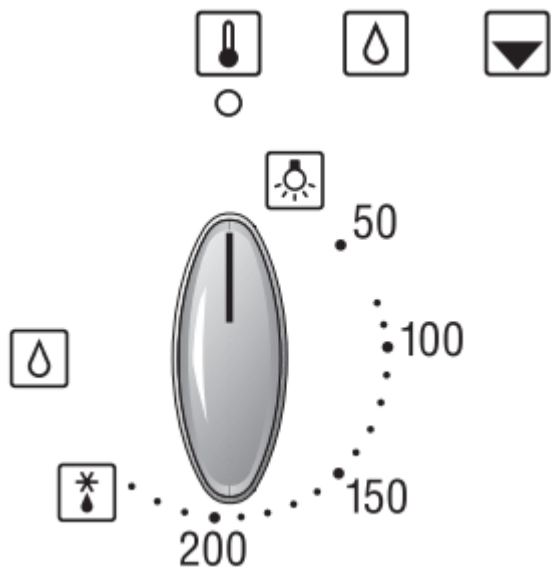

Switching the oven ON:

1. Set the temperature control knob to the desired temperature.

The selected temperature will be controlled automatically.

The red oven temperature control lamp illuminates when the oven is first switched on, and extinguishes when the required temperature has been reached.

Mini oven

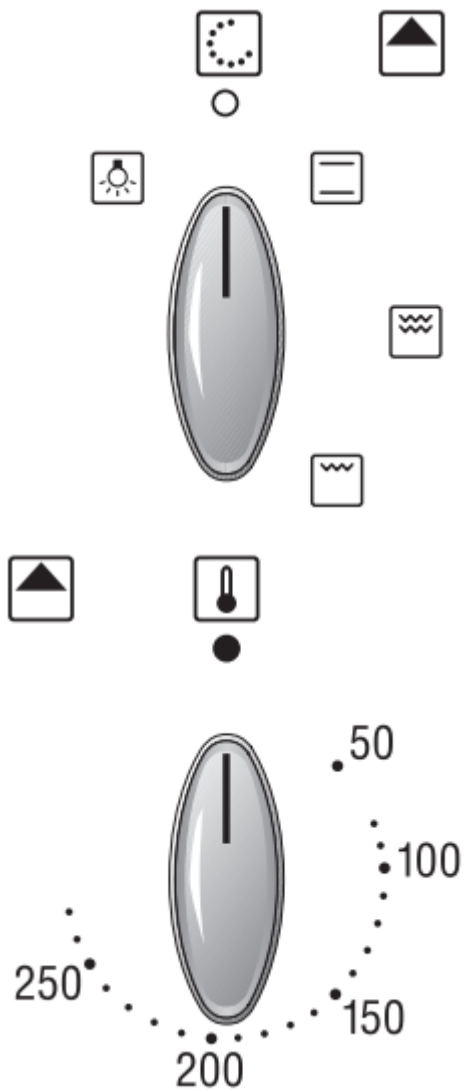

Before switching on your oven, you should decide which heating system you wish to use.

Switching the oven ON:

1. Use the function selector to determine the desired system.
2. Set the temperature control knob to the desired temperature.

The selected temperature will be controlled automatically.

The oven temperature control lamp illuminates when the oven is first switched on, and extinguishes when the required temperature has been reached.

Switching the oven OFF:

To switch the oven OFF, turn both the temperature selector and functions selector to the »0« position.

Notes:

The appliance features a cooling fan which runs until the oven has cooled down.

Baking

Main oven

Using baking tins



Always place baking tins in the centre of the baking wire shelf. We recommend dark metallic baking tins

Notes :Light coloured baking tins made from thin-wall materials lead to longer baking times and uneven browning of the cake.

You can influence the degree of browning by changing the temperature setting.

If a cake collapses after removing it from the oven, consider using a longer baking time, or use a slightly lower temperature setting

Using tinplate baking tins



Circotherm

Shelf position **1**



Top/bottom heat

Shelf position **1**

If the cake bottom gets too dark:

Check the shelf position. Shorten the baking time, and possibly use a lower baking temperature.

If the cake bottom stays too light:

Check the shelf position. Increase the baking time, select a lower temperature, or use a dark metal baking tin.

Do not place baking tins or high cakes too close to the rear oven wall.

Cooking Tips and Helpful Hints

The bottom of a cake baked on a baking sheet stays too light	Remove from the oven all baking sheets or universal pan currently not in use.
The bottom of a cake baked in a tin stays too light	Use a wire shelf and not a baking sheet to support the cake tin during baking.
The bottom of cake or cookies gets too dark	Set cake or cookies into a higher set of shelf position.
The cake gets too dry	Select a slightly higher oven temperature, and shorter baking time.
The cake is too moist on the inside	Choose a slightly lower baking temperature. Note: Higher temperatures do not shorten baking times (done on the outside, raw on the inside). Choose a slightly longer baking time, allow the dough to rise slightly longer. Add less liquid to the dough.

<p>When baked with circotherm, cake baked in round or square tins gets too dark at the rear</p>	<p>Avoid blocking the air vents at the rear wall of the oven cavity with the cake tins.</p>
<p>Very moist cake dough (e.g. fruit cake) causes a lot of steam to generate in the oven that condenses on the oven door.</p>	<p>You can let the steam escape from the oven and thereby reduce the forming of water droplets by briefly and carefully opening the oven door (once or twice, in case of longer baking times more often).</p>
<p>Very uneven browning when using circotherm</p>	<p>Check the shelf position.</p>
<p>Cake collapses when taken out of the oven</p>	<p>Use less liquid.</p>
<p>To save energy</p>	<p>Preheat only if expressly required by the recipe.</p> <p>Dark baking tins have a higher degree of heat absorption.</p> <p>Residual heat: In the case of longer baking times, you can switch off the oven 5-10 minutes before the full baking time has elapsed.</p>

Roasting

Main oven

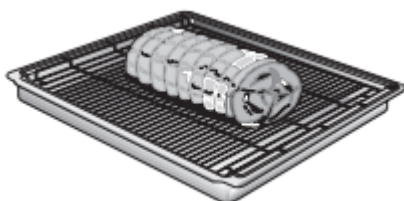

Place the wire shelf into the universal pan and slide them together into the same shelf position.

Meat can be roasted in the oven in a particularly economical fashion if the weight of the cut exceeds 750 grams

Roasting in an uncovered pot

Rinse the universal pan and/or the roaster with water, and place the meat into it.

With fat meat and poultry, pour 125 to 250 ml of water (to suit the size and kind of roast) into the universal pan. At your discretion, baste lean meat with fat, or cover it with bacon strips.

The roast drippings collecting in the universal pan make a tasty gravy. Dissolve the drippings with hot water, bring to a boil, thicken with corn starch, season to taste and, if required, pass it through a strainer.

No preheating is required. Save energy by putting the roast into the oven while it is still cold.

Roasting in a covered pot

Place the meat into the roasting pot (or Dutch oven), cover it with a matching lid, and place it on the grill in the oven. We recommend that beef roast be prepared in a covered roasting pot.

Tips

Big, high roasts, goose, turkey, duck

= Long roasting times, low temperatures

Medium sized, low roasts

= Medium roasting times, medium temperatures

Small, flat roasts

= Short roasting times, high temperatures

Roasting time per cm of meat height without bones app. 13-15 minutes

Roasting time per cm of meat height with bones app. 15-18 minutes

We recommend using the lower of the stated temperatures first.

In general, the lower temperature ensures a more even browning.

We recommend turning the roast after half or two thirds of the roasting time have elapsed when using the setting .

For roasting, use only cookware with oven-proof handles.

Prepare large roast directly in the universal pan, without using the wire shelf.

Smaller cuts of meat can be roasted on aluminium foil. To do so, bend the edges of the foil upward, as if to form a dish, and place it on the wire shelf.

After the end of the selected roasting time and with the oven switched OFF, leave the roast in the closed oven for approx. 10 minutes.

The roast is not done on the inside

Use a lower roasting temperature.

Note: Higher temperatures do not shorten roasting times (done on the outside, raw on the inside). Choose slightly longer roasting times.

Very moist roasts (e.g. roasts prepared with water) cause a lot of steam to generate in the oven that condenses on the oven door.

You can let the steam escape from the oven and thereby reduce the forming of water droplets by briefly and carefully opening the oven door (once or twice, in case of longer roasting times more often).

Mini oven

<p>Roasting with conventional heat</p>	<p>Follow the steps above. With fatty meat 125 - 250 ml (4 - 8fl oz) of water can be poured into the roasting pan.</p> <p>Baste the meat if desired.</p> <p>Place in a cold oven to save energy or pre-heat if desired.</p>
<p>Casseroling or pot-roasting in a covered dish</p>	<p>Some meats should be prepared in liquid in a covered casserole. This type of cooking is suitable for less tender cuts of meat.</p>
<p>Cooking tips</p>	<p>Place the casserole on the wire shelf at a suitable shelf position.</p> <p>Only use ovenproof cookware.</p> <p>Extra large turkeys and joints can be placed directly in the roasting pan and not on the wire shelf.</p> <p>Cover large turkeys with foil during cooking. Remove foil during the last hour.</p>

Grilling

Main oven

Circotherm grilling

Use this method for small cuts of meat – steaks, chops, sausages, bacon, chicken joints and fish.

Use the shelf and roasting pan together.

Season meat as required.

Place on shelf.

Do not turn food over – the hot air will circulate around the food cooking all sides.

Use a temperature of 180–190 °C.

Mini oven

Notes on grilling

Always close the oven door when grilling. The grilling temperatures are variable. Always use the wire shelf and the universal pan. Always place food to be grilled in the centre of the wire shelf. If the grill element (heating element) switches OFF automatically, the overheating protection was activated. The radiator will be reactivated after a short period of time.

Place the wire shelf into the universal pan and slide them together into the same shelf position.

Surface grilling

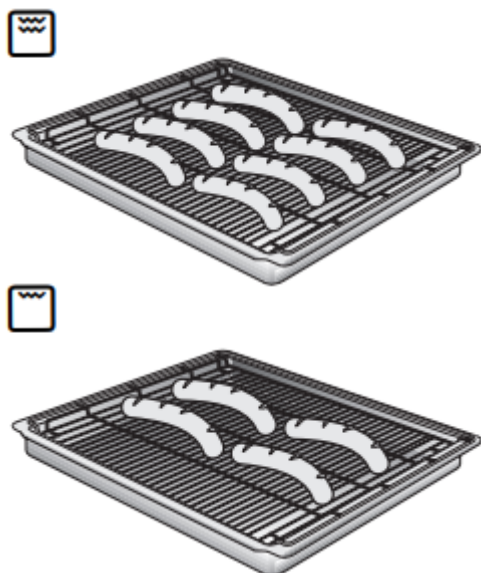

Used for smaller dishes having little height/thickness. (Always use the wire shelf and universal pan together. Turn the food after approx. two-thirds of the grilling time has elapsed. At your discretion, lightly baste the wire shelf and the food with oil.

Cleaning and Care



<p>Important cleaning basics</p>	<p>For cleaning, do not use abrasives, no corrosive cleaners, and no sharp objects.</p> <p>Do not scratch off burnt-in food residues, but soak them off with a moist cloth and dishwashing detergent.</p> <p>Cleaning products we particularly recommend can be purchased from our customer service.</p>
<p>Appliance exterior</p>	
<p>Stainless steel/ aluminium front</p>	<p>Use commercially available detergents applied to a soft, moistened cloth or a chamois.</p> <p>Do not use aggressive cleaning agents, abrasive sponges, or coarse cleaning cloths.</p> <p>On heavy soiling use commercial cleaning agents on matted stainless steel/aluminium surfaces.</p> <p>Please observe the manufacturer's instructions.</p>
<p>Enamel and glass</p>	<p>Use commercially available detergents applied to a soft, moistened cloth or a chamois.</p>
<p>Oven door pane</p>	<p>The temperature of the pane inside the oven door is reduced by a heat-reflecting coating.</p> <p>The reduced temperature ensures that visibility through the oven door window is not impaired.</p> <p>When the oven door is open, this coating may have a bright appearance. This is quite normal and does not indicate a quality defect.</p>
<p>Oven interior</p>	<p>Clean the oven after each use, especially after roasting or grilling.</p> <p>Food remnants burn in when the oven is reheated. The baked in remnants are very difficult to remove once burnt in.</p>
<p>Enamel areas in the oven</p>	<p>Note:</p> <p>To prevent soiling use:</p>



- the universal pan **to bake** very moist cakes.
- suitable utensils (frying pan) **for frying**.

For easier cleaning

you can switch on the oven lamp and take off the oven door.

For cleaning the mating surface of the oven door at the front of the oven, the door should be removed.

Use hot soapy water or a vinegar solution.

It is best to use oven cleaner if the oven is very dirty. Only use oven cleaner in a cold oven.

We recommend cleaning gels because these can be applied with greater precision.

WARNING Do not clean the warm oven with any of the cleaning products specifically designed for this purpose.

Leave the oven open so that it can dry after cleaning.

Note:

Enamel is baked on at very high temperatures.

This can cause some slight colour variation. This is normal and does not affect the function. Do not use coarse scouring pads or strong cleaning agents to remove such discolorations.

The edges of thin trays cannot be completely enamelled. As a result, these edges can be rough. Anti-corrosion protection is guaranteed.

Catalytic oven surfaces

Cleaning the catalytic surfaces of the oven

The rear wall of the oven and the oven ceiling is coated with self-cleaning enamel. The surface cleans itself while the oven is in operation. Large splashes sometimes only disappear after the oven has been used several times. Never use oven cleaner on the back wall of the oven. Should the enamel become slightly stained, this will not affect its self-cleaning properties.

AquaCleanse – main oven

The oven cleaning function featured in your oven is intended to help you keep your oven neat and tidy. An amount of cleaning solution is vaporised automatically. The combined effects of heat and steam soften the soil deposits on the oven wall enamel and facilitate their removal.

Caution:

Never pour cold water into the oven while it is still hot.

The cleaning system can only be activated **when the oven has cooled down completely** (room temperature).

Use normal water only, and **no distilled water**.

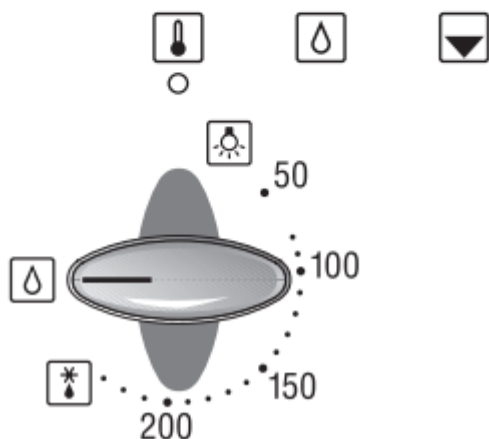
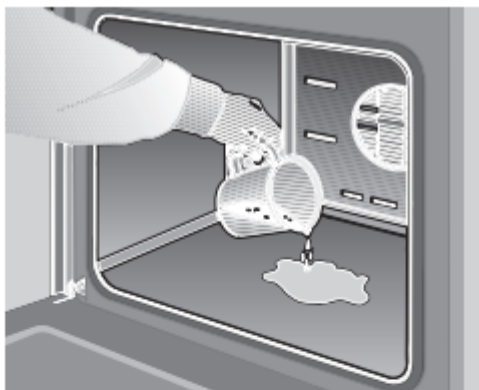

Activate oven cleaning:

1. Remove the baking sheet and the universal pan from the oven. The wire shelf may remain in the oven.

2. Pour approx. 400 ml of water mixed with a little dish washing liquid detergent into the floor pan of the oven cavity.

In the case of heavy soil build-up, you may wish to allow the cleaning solution to soak in for a while before you activate the cleaning function.

3. Close the oven door.

4. Turn the function selector to the  position.

The oven cleaning and the oven temperature control lamp are illuminated. After the initial heating time (approx. 4 minutes) the oven temperature control lamp extinguishes.

After a further 17 minutes the program cycle is completed. A buzzer sounds.

Switching the oven OFF:

Turn the function selector to the **0** position.

The oven cleaning control lamp extinguishes.

After deactivating the oven cleaning function

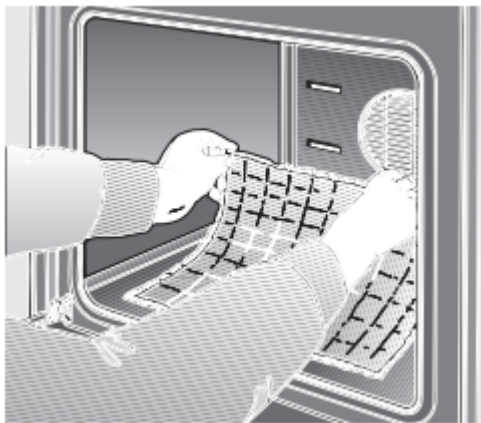

Cleaning tips:

Never leave the residual water in the oven for any length of time, e.g. overnight.

1. Open the oven door and pick up the remaining water with a large absorbent sponge cloth.
2. Using the detergent-soaked sponge cloth, a soft brush or a plastic pot scrubber, wipe of the oven interior.

Stubborn soil remnants can be removed with a cleaning scraper for glass-ceramic.

Caution: Use the scraper carefully, and do not apply the tool at too flat an angle, because the enamel could be scratched!

3. Calciferous deposits may be removed with a cloth soaked in vinegar.
4. Wipe clean with clear water and dry with a soft cloth (do not forget to wipe under the oven door seal).

Cleaning tips:

If the oven is heavily soiled, the procedure may be repeated after the oven has cooled.

If the oven is heavily soiled with grease, e.g. after roasting or grilling, we would recommend rubbing any stubborn dirt with detergent before activating the oven cleaning function.

After cleaning, leave the oven door in its slanted detent position, i.e., at a 30-degree angle, to allow the interior enamel surfaces to dry thoroughly.

Rapid drying

1. Place the oven door into the slanted detent position, at an angle of approximately 30 degrees.
2. Turn the function selector to the **50° C**. Allow oven to heat for 5 minutes.
3. Afterwards return the function selector and the temperature selector to the »0« position.

Removing/installing the oven door

Oven door

Note: To make the manual cleaning steps following the automatic oven cleaning function more convenient, the appliance features the following options

Removing the oven door

1. Fully open the oven door.
2. Move the catch levers on the right and left-hand sides to the fully open position.



3. Placing the door at an upward angle toward you, grasp the door with both hands and lift it out of the hinges toward you.

When pulling the door out, make sure that you do not reach into the hinge. There is a risk of injury.

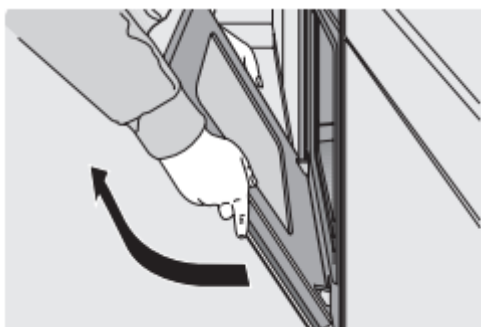

Hanging the oven door

1. Set both hinges into their respective receptacles on the left and right, and swing the oven door downward.
2. Close the catch levers on the left and right.
3. Close the oven door.

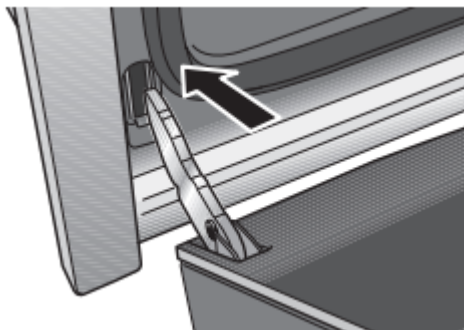

Shelf supports

Removing

You can remove the shelf supports for cleaning.

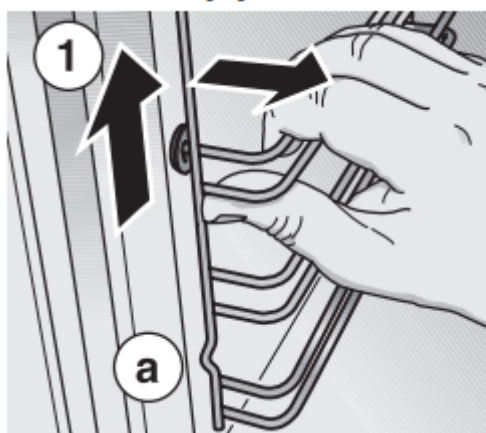

1. At the front, press the shelf support up and detach the front clip.

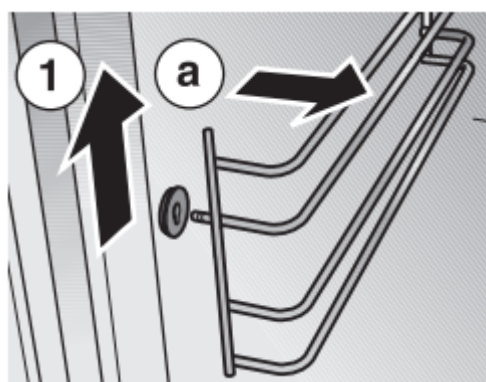

2. At the back, pull the shelf support forward and take it off. Clean the shelf support using washing-up liquid and pan scrapers or brushes.

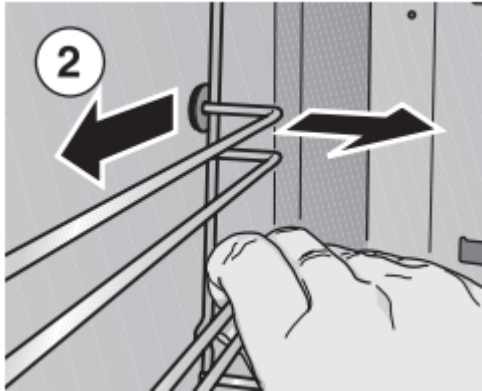

Replacing

The shelf supports fit on the left and right side.

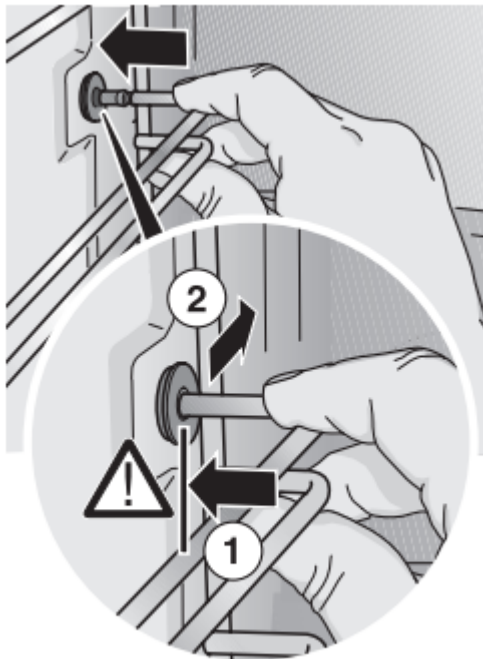

For the main oven: The indentation (a) must always be at the bottom.

For the mini oven: The extension (a) must always be at the top.

1. At the back, put the shelf support in as far as it goes.
2. Press the shelf support backwards until it clicks into place in the front.

Replacing the oven light

Main oven

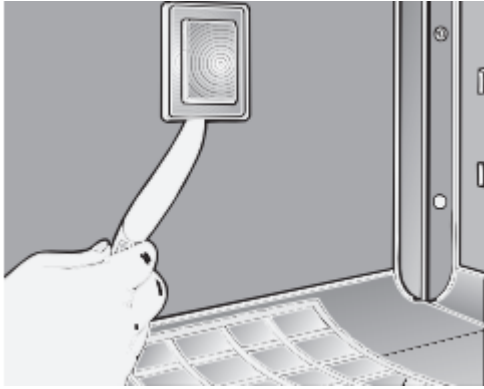

1. To prevent damage, place a cloth into the cold oven.
2. Remove the glass cover by inserting a knife or similar object between the glass and the frame.
3. Replacing the lamp:
 - Type: Incandescent bulb E 14, 230 - 240 V, 25 W, heat resistant to 300° C.
 - You can obtain this lamp from our spares department.

Mini oven

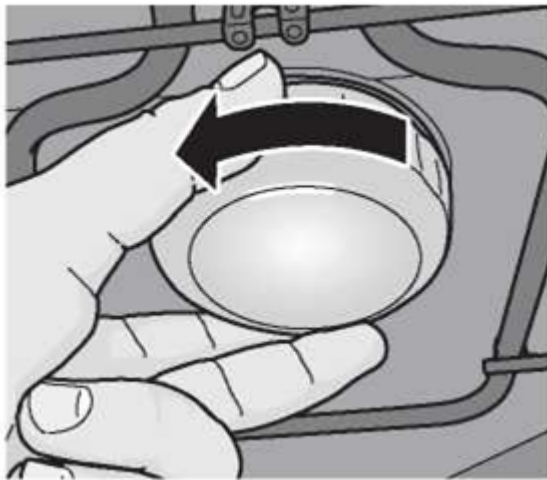

1. To prevent damage, place a towel into the cold oven.
2. Unscrew the lamp cover by turning it counter-clockwise.
3. Replace the lamp.
 - Type: Incandescent bulb E 14, 220 - 240 V, 40 W, heat-resistant to 300° C
 - You may obtain this bulb from your customer service or from your appliance dealer.

Replacing the oven door seat

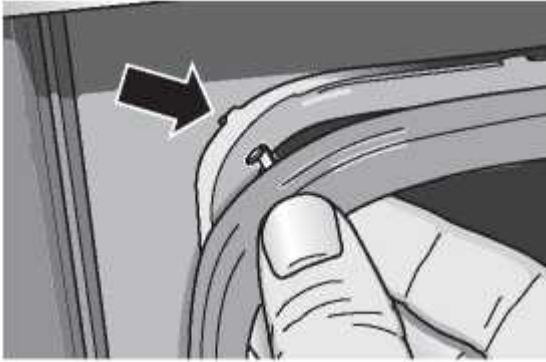

Remove the defective oven door seal by simply unhooking it.

You may obtain the new oven door seal from your customer service.



Trouble-shooting Guide

Calling the customer service is not always really necessary. In some cases, you can remedy the situation yourself. The following table may contain some helpful tips.

Important general safety guidelines:

Service or repair work on the electronic components may only be performed by a qualified expert. Without exception, prior to starting such repairs, the appliance must be disconnected from the mains. This may be accomplished by tripping the automatic fuse or by removing the fuse from the fuse box that controls your flat or apartment.

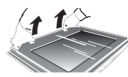
Problem	Possible cause	Remedy
. . . if there is a general failure of all electrical functions, i.e., the control lamps have suddenly ceased to function.	Defective fuse	Check the fuse in the fuse box, and replace if required.
. . . if liquids or thin viscous dough are distributed at a visibly uneven thickness?	The appliance has not been placed or installed plumb-and-level.	Level the appliance using the leveling feet, or check the installation.
. . . if the oven suddenly stop functioning?	The electronic clock is set to an automatic timing cycle.	Set electronic clock to operation without automatic timer: 1. Press the ◀▶ button. 2. Reset ON time → to 0:00.
. . . if the oven suddenly stop functioning and the electronic clock flashes 0:00?	The power supply was briefly interrupted.	Reset the time of day.
. . . if electronically control functions fail?	Energy pulses (e.g. lightning flash).	Reset the relevant functions.
. . . if the oven cleaning control lamp fails to illuminate after the function has been activated?	Temperature inside oven cavity is still too high, i.e. after prolonged use of the hotplates.	Prior to using the oven cleaning function, the oven must be allowed to cool completely.
	Defective control lamp.	Replacement only by an authorised expert.

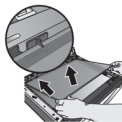
<p>. . . if smoke is generated during roasting or grilling?</p>	<p>Roasting temperature to high.</p> <p>Wire shelf or universal pan slid in incorrectly.</p>	<p>Place wire shelf into universal pan and insert together in shelf position.</p>
<p>. . . if enamelled slide-in parts show mat bright stains?</p>	<p>Normal occurrence due to dripping meat juices.</p>	<p>Not available.</p>
<p>. . . if the glass pane or window of the oven door become clouded?</p>	<p>Normal occurrence, due to existing temperature difference.</p>	<p>Switch on the oven for app. 5 minutes at 100° C.</p>
<p>. . . if the oven shows increasing condensation water?</p>	<p>Normal occurrence, e.g. in the case of cakes with very moist topping (fruit) or roasts.</p>	<p>Briefly open the oven door occasionally during baking or roasting, wipe up the condensation water after operation.</p>
<p>. . . if the panes of the oven door are dirty on the inside after some time of use?</p>	<p>Normal soiling</p> 	<p>Remove the oven door and place it facing down on a clean and soft surface.</p> <p>Grip the door glass next to the hinges, pull the upward and remove it.</p>
		<p>Press in the retaining clip with your thumb on one side and disengage the inner door glass e.g. with the spatula, then repeat on the other side.</p>
		<p>Installation after cleaning:</p> <p>Insert inner door glass into the holder. First engage the right side and then the other side.</p>
		<p>Hang door glass and press down next to the hinges until it clicks into place.</p>

Warning

This content is compiled from multiple sources and is provided for reference purposes only. It may not be complete or fully applicable to all situations. If you are unable to resolve your issue, please contact the product manufacturer or an authorized service provider for official support.

Document generated by [ManualsFile](#)

