

Features & Specifications

Microwave features

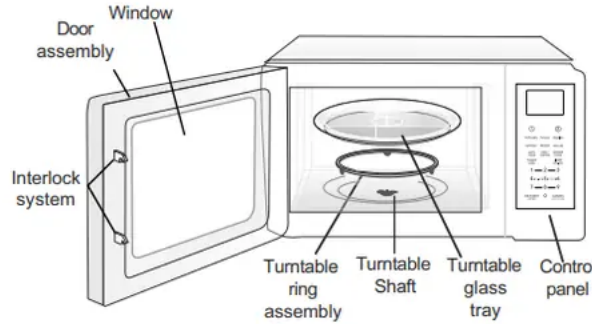

Control panel

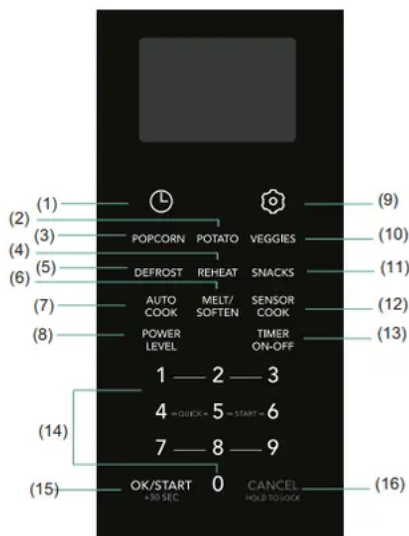

- (1) Clock
- (2) Potato
- (3) Popcorn
- (4) Reheat
- (5) Defrost
- (6) Melt/Soften
- (7) Auto Cook
- (8) Power level (10 power level available)
- (9) User Pref
- (10) Veggies
- (11) Snacks
- (12) Sensor Cook
- (13) Timer On-Off
- (14) Number Keys
- (15) Ok/Start/+30 Sec.
- (16) Cancel/Hold To Lock:
clears all previous settings pressed before cooking starts.
During cooking: press once to stop oven; twice to stop and clear all entries.

Before Operating

Setting the clock

Example: setting clock display for 9:00:

1. Press clock pad once for 12 hour clock system.



2. Enter time using number pads.

9 0 0



OK/START
+30 Sec

3. Press OK/START/+30 sec pad.



Microwave utensil guide

Use	Do not use
<p>Oven proof glass (specifically treated for high intensity heat): Utility dishes, loaf dishes, pie plates, cake plates, liquid measuring cups, casseroles and bowls without metallic trim.</p> <p>China:</p> <p>Bowls, cups, serving plates and platters without metallic trim.</p> <p>Plastic:</p> <p>Plastic must be rated as microwave-safe.</p> <p>Plastic wrap (as a cover) - lay the plastic wrap loosely over the dish and press it to the sides. Vent plastic wrap by turning back one edge slightly to allow excess steam to escape. The dish should be deep enough so that the plastic wrap will not touch the food. Use plastic dishes, cups, semi-rigid freezer containers and plastic bags for short cooking times. Use these with care because the plastic may soften from the heat of the food.</p> <p>Look for the manufacturer's label for any special instructions for use in the microwave oven.</p> <p>Paper:</p> <p>Paper towels, waxed paper, paper napkins and paper plates with no metallic trim or design. Look for the manufacturer's label for any special instructions for use in the microwave oven.</p>	<p>Metal utensils:</p> <p>Metal shields the food from microwave energy and produces uneven cooking. Also, avoid metal skewers, thermometers or foil trays. Metal utensils can cause arcing, which can damage your microwave oven.</p> <p>Metal decoration:</p> <p>Bowls, cups, serving plates and platters with metallic trim.</p> <p>Aluminum foil:</p> <p>Avoid aluminum foil.</p> <p>Wood:</p> <p>Wooden bowls and boards will dry out and may split or crack when used in the microwave oven. Baskets made of wood will react in the same way.</p> <p>Tightly covered utensils:</p> <p>Be sure to leave openings for steam to escape from covered cooking items.</p> <p>Pierce plastic pouches of vegetables or other food items before cooking.</p> <p>Tightly closed pouches may explode. Look for the manufacturer's label for any special instructions for use in the microwave oven.</p> <p>Brown paper:</p> <p>Avoid using brown paper bags. They absorb heat and can burn.</p> <p>Flawed or chipped cooking utensils:</p> <p>Any utensil that is cracked, flawed or chipped may break in the oven.</p> <p>Metal twist ties:</p> <p>Remove metal twist ties from plastic or paper bags. They become brittle and could cause a fire.</p>

Manual Operation

Setting the timer

Example: setting timer for 5 minutes

1. Press Timer pad once. 
2. Enter desired time using number pads. (timer may be set up to 99 minutes and 99 seconds).

5 0 0

3. Press **Timer** pad again. 

When finished, you will hear a series of beeps.

Safety Lock

You may lock the control panel to prevent the microwave from being accidentally started or used by children.

The safety lock feature is very useful when cleaning the control panel. The lock will prevent accidental programming when wiping the control panel.

Example: to set the safety lock ON:

Press and hold the **Cancel** pad for more than 3 seconds. The lock icon will appear in the display window with 1 beep.

Example: to change the safety lock from ON to OFF

Using Quick Start

1 — 2 — 3
4 — Quick — 5 — Start — 6
7 — 8 — 9

Microwave heating or cooking may be quickly set at 100% power level for 1-9 minutes. Use the number keys 1-9 to choose the desired minutes of cook time (this option will only work using the 1-9 numeric pads.)

Example: to quickly heat for 2 minutes at 100% power:

Press number pad for desired minute(s). The **2** microwave will start at once.

Heating with high power level

Example: to heat for 5 minutes and 30 seconds at 100% power:

5 3 0

1. Use the number pads to enter desired heating time.

NOTE: For time sets that start with numbers 1 - 9, the remaining numbers must be entered within 2 second from the first key press, otherwise the Quick Start time will be used.

OK/START

2. Press OK/START/+30 sec pad. +30 Sec

When finished, you will hear a series of beeps.

Heating with lower power levels

Using the highest power level to heat foods does not always give the best results when some types of food need slower cooking, such as roasts, baked goods or custards. Your oven has nine other power levels you may choose

Example: to heat for 4 minutes and 30 seconds at 70% power:

1. Enter cook time **4 3 0**

2. Press Power Level pad once for power level PL-HI **Power Level**

3. Press Power Level four times to change to 70% power level. PL-70 appears in the display.

4. Press OK/START/+30 sec pad. **OK/START**
+30 Sec

NOTE: For time sets that start with numbers 1 - 9, the remaining numbers must be entered within 2 second from the first key press, otherwise the Quick Start time will be used.

When finished, you will hear a series of beeps.

Heating with multiple cooking stages

For best results, some microwave recipes call for different power levels or different lengths of time for cooking. Your microwave may be set to change from one stage to another automatically (2 stages maximum).

Example: to cook food at 80% power for 3 minutes and then 50% power for 6 minutes 30 seconds:

1. Use the number pads to enter heating time for the 1st stage. **3 0 0**
2. Press Power Level pad. **Power Level**
3. Press Power Level three times to change to 80% power level. PL-80 appears in the display.
4. Use the number pads to enter heating time for the 2nd stage. **6 3 0**
5. Press **Power Level** (within 1 second) for the 2nd stage. **Power Level**
6. Press Power Level six times to change to 50% power level for the 2nd stage. PL-50 appears in the display.
7. Press OK/START/+30 sec pad. **OK/START**
+30 Sec

When finished, you will hear a series of beeps.

NOTE: The “Convenience operation” can’t be set as one of multiple cooking.

Adding cook time (+30sec)

Pressing the OK/START/+30 sec pad once starts 30 seconds of cooking at a 100% power level. Pressing the OK/START/+30 sec pad during cooking adds 30 seconds (for each press) to the cook time.

Auto Cook

Do not leave microwave unattended during any of auto cook selections.

Key Press	Food	Amount	Key
Auto Cook x1	Bacon	1 - 3 slices	1 - 3
Auto Cook x2	Frozen Entrée	10 oz 20 oz	-
Auto Cook x3	Rice	1 cup 2 cups	-

Example: to cook Rice.

1. Auto Cook pad 3 times.
2. Press OK/START/+30 sec pad. **OK/START**
+30 Sec



The microwave will beep when finished.

USING AUTO DEFROST

Three defrost sequences are preset in the oven. The auto defrost feature provides you with the best defrosting method for frozen foods. The cooking guide will show you which defrost sequence is recommended for the food you are defrosting.

For added convenience, the Auto Defrost includes a built-in beep mechanism that reminds you to check, turn over, separate, or rearrange the food in order to get the best defrost results. Three different defrosting levels are provided:

1. **MEAT**
2. **POULTRY**
3. **FISH**

Available weight is 0.1-6.0 lbs.

Suppose you want to defrost 2.0 lbs of meat.

1. Press Defrost pad. **Defrost**
2. Press OK/START/+30 sec pad. **OK/START**
+30 Sec
3. Enter cook weight **2 0**
4. Press OK/START/+30 sec pad **OK/START**
+30 Sec

(Refer the table on next page)

KEY PRESS	Category	WEIGHTS YOU CAN SET (tenths of a pound)
Defrost	Meat	0.1 to 6.0
Defrost	Poultry	0.1 to 6.0
Defrost	Fish	0.1 to 6.0

Popcor

The popcorn feature lets you pop 3 different commercially packaged microwave popcorn sized bags. Use the table below to determine the setting to use:

Key	Food
Popcorn x1	3.3 oz. (default)
Popcorn x2	3.0 oz.
Popcorn x3	1.75 oz.

SETTING VEGGIES

The Veggies quick touch pad lets you cook fresh and frozen vegetables.

Key	Food
Veggies x1	Fresh
Veggies x2	Frozen

Suppose you want to cook frozen veggies.

1. Press Veggies pad 2 times (refer to table above).
2. Press OK/START/+30 sec pad.

SETTING MELT/SOFTEN

The oven uses low power to melt and soften items. See the following table.

Key	Food	Amount	Key
Melt / Soften x1	Melt Butter	1 stick	1
		2 sticks	2
Melt / Soften x2	Melt Chocolate	2 oz.	2
		4 oz.	4
		8 oz.	8
Melt/ Soften x3	Soften Ice Cream	1 Pint	1
		1.5 Quart	2
Melt / Soften x4	Soften Cream Cheese	3 oz.	3
		8 oz.	8

Suppose you want to melt 8 oz. of Chocolate.

1. Press Melt/Softens pad 2 times (refer to table above). **Melt/Softens**
2. Press OK/START/+30 sec pad.
3. Enter cook weight **8**
4. Press OK/START/+30 sec pad.

SETTING SNACKS

The Snacks quick touch pad lets you cook frozen pizza, hot dog, meal in a cup and frozen kids meal.

Key	Food	Amount	Key
Snacks x1	Frozen MW Pizza	6-8oz	Default
Snacks x2	Hot Dog	1-6	1-6
Snacks x3	Meal in a Cup	1 cup	Default
Snacks x4	Frozen Kids Meal	1, 2	1, 2

Sensor Operating

Sensor Cook Operating Tips

The **Sensor Cook** categories are designed to detect the increasing humidity released by the food during the cooking process. The microwave oven sensor will automatically adjust the cooking time to the type and amount of food. The food categories that are controlled with the humidity sensor are::

Key	Food
Sensor Cook x1	Frozen Breakfast (8-12oz)
Sensor Cook x2	Ground Meat
Sensor Cook x3	Fish Seafood
Sensor Cook x4	Chicken Breast

For best results, do not use one of the Sensor Cook categories twice in succession on the same food portion. This may result in severely overcooked or burnt food. If the food appears to be undercooked, use one of the Easy Set pads or cook time pads to add more time.

Additional sensor cook suggestions are:

Never start with less than 4 oz. of food.

Use proper containers and covers for best sensor cooking results.

Always use microwave-safe containers.

Never use tight sealing plastic containers.

They will prevent steam from escaping and this will mislead the sensor, usually causing the food to overcook.

Be sure the outside of the cooking containers and the cavity of the microwave oven are dry before placing food in the oven. Excessive moisture turning into steam that does not result from the food cooking can mislead the sensor.

Reheat

The reheat feature is designed to detect the increasing humidity released by the food during the cooking process. The microwave oven sensor will automatically adjust the cooking time to the type and amount of food.

Key	Selection	Amount	Key
Reheat x1	Beverage	1-3 cups	1-3
Reheat x2	Dinner Plate	1-2 plates	Default
Reheat x3	Soup - Sauce	1-2 cups	1-2
Reheat x4	Casserole	1-4 servings	Default

Notes concerning sensor reheat:

- For casseroles, add 2-3 tablespoons of liquid, cover with lid or vented plastic wrap. Stir when instructed from display.
- For canned foods, empty contents of can into a casserole dish or serving bowl. Cover dish with lid or vented plastic wrap. Let stand a few minutes before serving.
- For plates of food, arrange food on plate and add any butter or gravies, etc. Cover with loose-fitting lid or vented plastic wrap. After reheating, let stand a few minutes be

Baked Potato

The potato feature cooks 1-4 baked potato automatically (starting from room temperature).

1. Press the **Potato**.
2. Press OK/START/+30 sec pad 2 times.

Convenient Features

USER REFERENCE

This section gives instructions for operating each function. Please read this section carefully.

USER PREF

The microwave oven has settings that allow you to customize the operation for your convenience. Below is the table showing the various settings. Touch the User Pref key multiple times to scroll to the desired setting function.

Key	Function
User Pref x 1	Volume
User Pref x 2	Weight
User Pref x 3	Power Save
User Pref x 4	Demo Mode



SETTING AUDIO LOW/MED/HIGH/OFF

Suppose you want to turn on the Volume Off.

1. Press the User Pref pad. 
2. Press **OK/START**  **+30 Sec** pad when display indicates volume level is off.



SETTING DEMO MODE

Suppose you want to enter Demo Mode.

1. Press the User Pref pad four times. 
2. Press **OK/START**  **+30 Sec** pad.



SETTING WEIGHT LBS/KG

Suppose you want to toggle weight between pounds & kilograms.

1. Press the User Pref pad twice. 
2. Press **OK/START**  **+30 Sec** pad.

SETTING ENERGY SAVINGS

Suppose you want to set the energy savings.

1. Press the User Pref pad three times. 
2. Press **OK/START**  **+30 Sec** pad.

Care & Cleaning

Cleaning suggestions

For best performance and for safety reasons, keep the oven clean inside and outside. Take special care to keep the inner door panel and oven from frame free of food and grease build-up.

Never use rough scouring powder or pads on the microwave. Wipe the microwave oven inside and out with a soft cloth and warm (not hot) mild detergent solution. Then rinse and wipe completely dry.

Wipe spatters immediately with a wet paper towel, especially after cooking greasy foods like chicken or bacon.

Follow these instructions to clean and care for your microwave oven:

Keep the inside (cavity) of the oven clean. Food particles and spilled liquids can stick to the oven walls, causing the oven to work less efficiently.

Wipe up spills immediately. Use a damp, clean cloth and mild detergent. **DO NOT** use harsh detergents or abrasive cleaners.

To help loosen baked-on food particles or liquids, heat 2 cups of water (add the juice of 1 lemon if you desire to keep the oven fresh smelling) in a 4 cup measuring glass at High power for 5 minutes or until boiling. Let stand in oven cavity for 1 or 2 minutes

Remove the glass turntable tray from the oven when cleaning the oven cavity or tray. To prevent the glass turntable from breaking, handle with care and do not put it in water immediately after cooking. Wash the turntable tray with mild detergent

Clean the outside surface of the microwave with mild detergent and a clean damp cloth. Dry with a clean soft cloth .To prevent damage to the operating parts of the oven,do not let water seep into any vents or openings.

Wash the oven door window with very mild soap and water. Be sure to use a soft clean cloth to avoid scratching.

If steam accumulates inside or outside the oven door, wipe with a soft cloth. Steam can accumulate when operating the oven in high humidity and in no way indicates microwave leakage.

Never operate the oven without food in the oven cavity; this can damage the magnetron tube or glass tray.

Before You Call

Troubleshooting guide

Before you call a repair person for your microwave, check the list below for possible easy solutions to some common problems.

Neither the microwave's display or oven operates

Properly insert the plug into a grounded power outlet.

Remove the plug from the outlet, wait 10 seconds, then plug the microwave in again.

Check the household circuit breaker.

Plug the microwave into a different power outlet.

The oven display works, but the oven will not operate -

Make sure the oven door is closed securely and completely.

Check to see if packing material or other materials are stuck to the door seal.

Check for damage to the oven door. Contact service if damaged.

Press the **CANCEL** pad twice and attempt to re-enter cooking instructions.

Plug the microwave into a different power outlet.

The power goes off before the cook time has elapsed -

If there has been a power interruption, remove the plug from the outlet; wait 10 seconds, then plug the microwave in again. If there was a power outage, the time indicator in the display will show **00:00**.

Reset the clock and any cooking instructions

Check the household circuit breaker.

Press the **CANCEL** pad twice and attempt to re-enter cooking instructions.

Plug the microwave into a different power outlet.

Food is cooking too slowly -

Make sure the oven is on a separate 20 amp circuit line. Operating another appliance on the same circuit can cause a voltage drop.

You see sparks or arcing -

Remove any metallic utensils, cookware or metal ties from the oven cavity.

The turntable makes noises or sticks

Clean the turntable, roller ring and oven cavity bottom.

Make sure the turntable and roller ring are positioned correctly.

Using your microwave causes TV or radio interference -

This is similar to the interference caused by other small appliances, such as hair dryers. Move your microwave further away from other appliances.

Please note: If the oven is set to cook for more than 30 minutes at 100% power level, it will automatically adjust itself to a 80% power level after 30 minutes to avoid overcooking

Warning

This content is compiled from multiple sources and is provided for reference purposes only. It may not be complete or fully applicable to all situations. If you are unable to resolve your issue, please contact the product manufacturer or an authorized service provider for official support.

Document generated by [ManualsFile](#)