

## Operating Instructions

### Features of Your Microwave

(Throughout this manual, features and appearance may vary from your model.)

#### Features

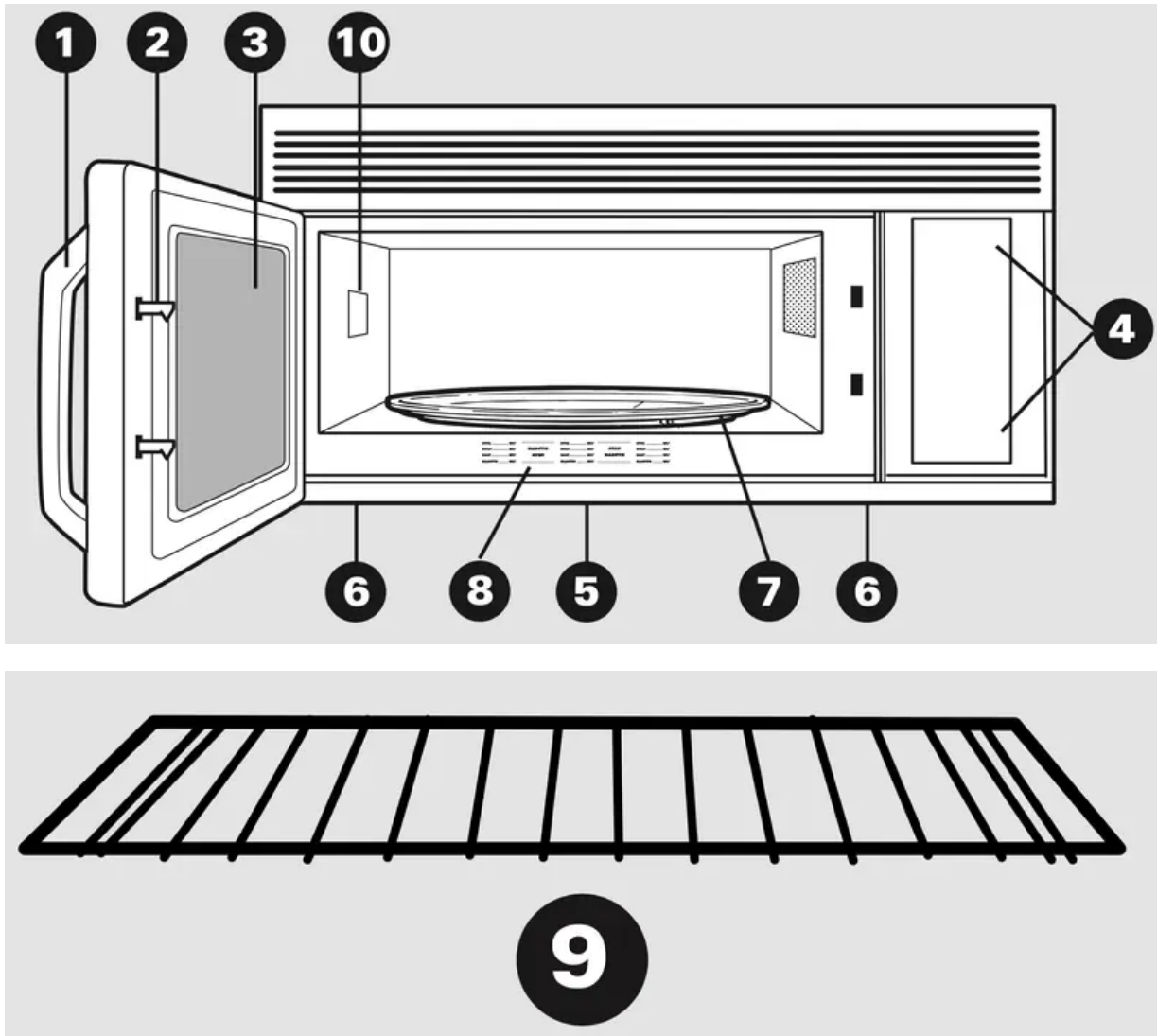

1. **Door Handle.** Pull to open the door. The door must be securely latched for the microwave to operate.
2. **Door Latches.**
3. **Window with Metal Shield.** Screen allows cooking to be viewed while keeping microwaves confined in the oven.
4. **Touch Control Panel.**
5. **Cooktop Light.**

6. **Grease Filters.**
7. **Removable Turntable.** Turntable and support **must** be in place when using the oven. The turntable may be removed for cleaning.
8. **Convenience Guide.**
9. **Shelf** (on some models). Lets you microwave several foods at once. Food microwaves best when placed directly on the turntable.
10. **Rating Plate.** Located on the inside wall of the microwave oven.

## **The Controls on Your Microwave Oven**

(Throughout this manual, features and appearance may vary from your model.)

**You can microwave by time, temperature or with the convenience features.**

### **Time Features**

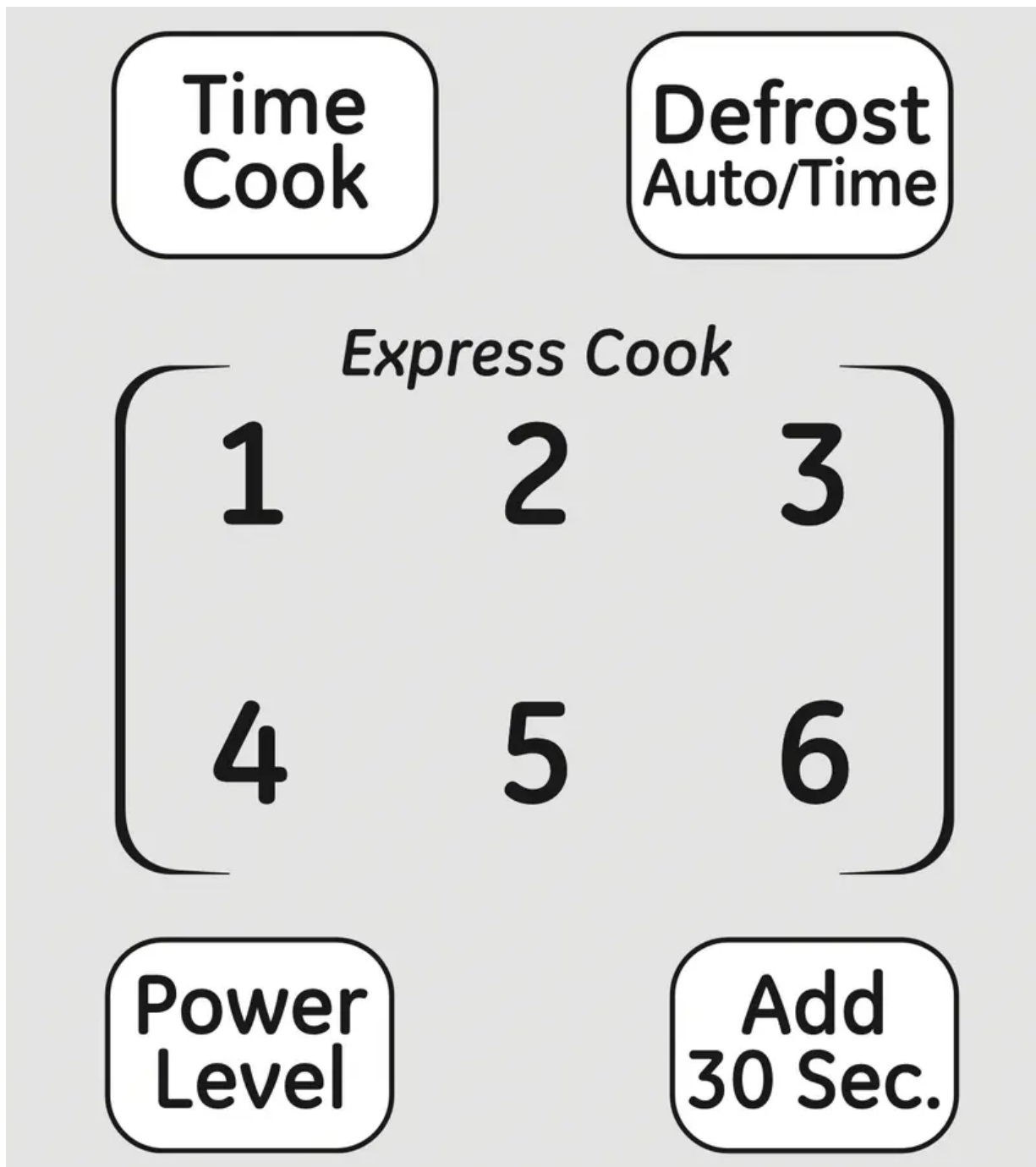

**Time Cooking**

<i>Press</i>	<i>Enter</i>
<b>TIME COOK I &amp; II (Press once or twice)</b>	Amount of cooking time.
<b>DEFROST AUTO/TIME (Press twice)</b>	Amount of defrosting time.
<b>EXPRESS COOK</b>	Starts immediately!
<b>POWER LEVEL</b>	Power level 1–10.
<b>ADD 30 SEC</b>	Starts immediately!

**Convenience Features**



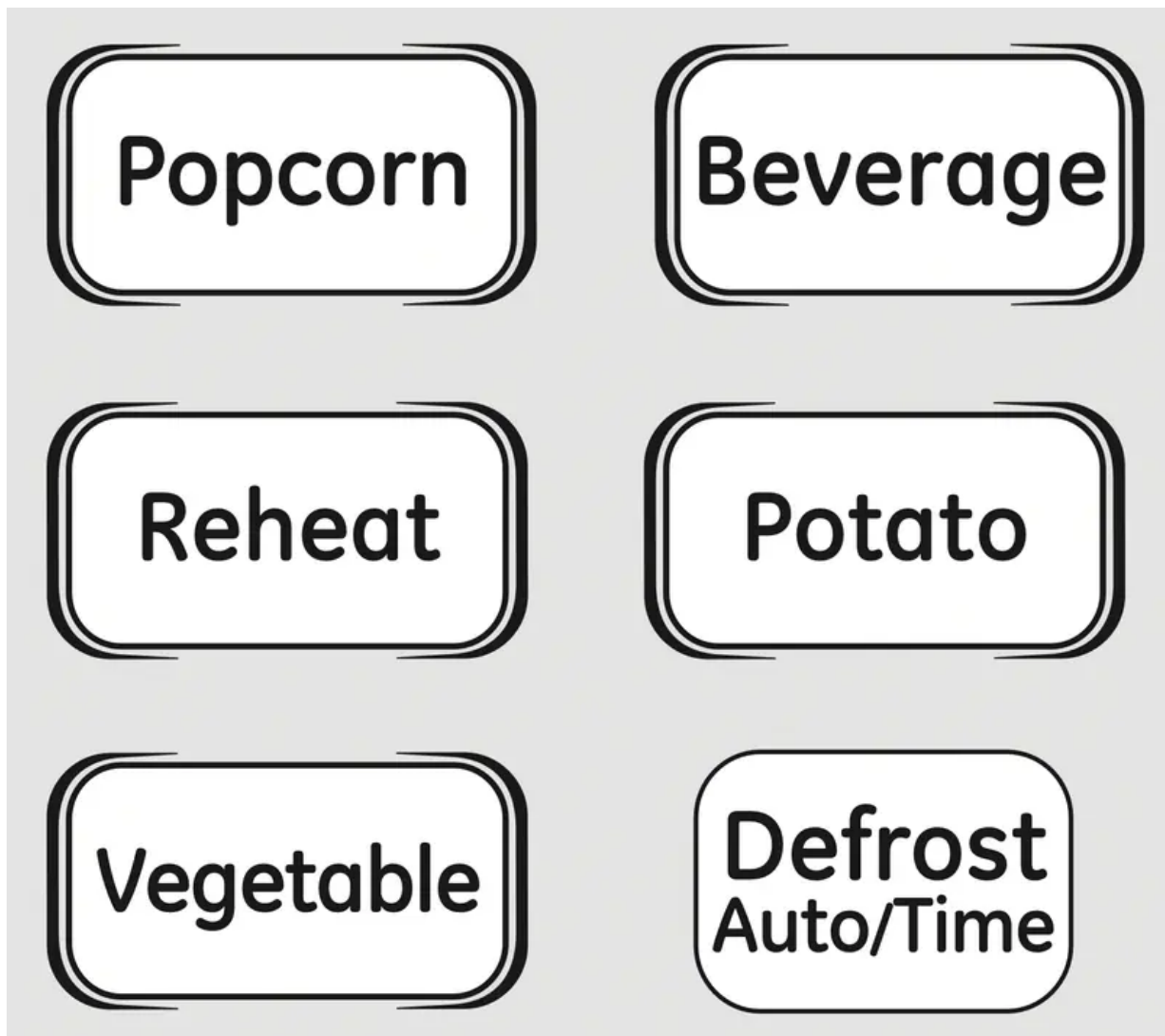

<i>Press</i>	<i>Enter</i>	<i>Option</i>
<b>POPCORN</b>	Starts immediately!	more/less time serving size
<b>BEVERAGE</b>	Starts immediately!	serving size
<b>REHEAT</b>	(See Reheat Guide)	serving size
<b>POTATO</b>	Starts immediately!	serving size
<b>VEGETABLE (on some models)</b>	Starts immediately!	food type/serving size
<b>DEFROST AUTO/TIME (Press once)</b>	Food weight	

### Changing Power Levels

**Power  
Level**

*Express Cook*

**1 2 3**  
**4 5 6**

**7 8 9**

**0**  
**DISPLAY**

**Start**

## How to Change the Power Level

The power level may be entered or changed immediately after entering the feature time for TIME COOK, TIME DEFROST or EXPRESS COOK. The power level may also be changed during time countdown.

1. Press **TIME COOK** or select **Time Defrost**.
2. Enter cooking or select Time Defrost.
3. Press **POWER LEVEL**.
4. Select desired power level 1–10.
5. Press **START**.

Variable power levels add flexibility to microwave cooking. The power levels on the microwave oven can be compared to the surface units on a range. High (power level 10) or full power is the fastest way to cook and gives you 100% power. Each power level gives you microwave energy a certain percent of the time. Power level 7 is microwave energy 70% of the time. Power level 3 is energy 30% of the time.

A high setting (10) will cook faster but food may need more frequent stirring, rotating or turning over. Most cooking will be done on High (power level 10). A lower setting will cook more evenly and need less stirring or rotating of the food.

Some foods may have better flavor, texture or appearance if one of the lower settings is used. Use a lower power level when cooking foods that have a tendency to boil over, such as scalloped potatoes.

Rest periods (when the microwave energy cycles off) give time for the food to “equalize” or transfer heat to the inside of the food. An example of this is shown with power level 3—the defrost cycle. If microwave energy did not cycle off, the outside of the food would cook before the inside was defrosted.

Here are some examples of uses for various power levels:

- **High 10** - Fish, bacon, vegetables, boiling liquids.
- **Med-High 7** - Gentle cooking of meat and poultry; baking casseroles and reheating.
- **Medium 5** - Slow cooking and tenderizing such as stews and less tender cuts of meat.
- **Low 2 or 3** - Defrosting without cooking; simmering; delicate sauces.
- **Warm 1** - Keeping food warm without overcooking; softening butter.

## Time Features

### Time Cook

**Time  
Cook**

*Express Cook*

**1 2 3**  
**4 5 6**

**7 8 9**

**0**  
**DISPLAY**

Page 7  
**Start**



1. Press **TIME COOK**.
2. Enter cooking time.
3. Change power level if you don't want full power. (Press **POWER LEVEL**. Select a desired power level 1–10.)
4. Press **START**.

### **Time Cook I**

Allows you to microwave for any time up to 99 minutes and 99 seconds.

Power level 10 (High) is automatically set, but you may change it for more flexibility.

You may open the door during Time Cook to check the food. Close the door and press **START** to resume cooking.

### **Time Cook II**

Lets you change power levels automatically during cooking. Here's how to do it:

1. Press **TIME COOK**.
2. Enter the first cook time.
3. Change the power level if you don't want full power. (Press **POWER LEVEL**. Select a desired power level 1–10.)
4. Press **TIME COOK** again.
5. Enter the second cook time.
6. Change the power level if you don't want full power. (Press **POWER LEVEL**. Select a power level 1–10.)
7. Press **START**.

At the end of **Time Cook I**, **Time Cook II** counts down.

### **Cooking Guide for Time Cook I & II**

**NOTE:** Use power level High (10) unless otherwise noted.

<b>Vegetable</b>	<b>Amount</b>	<b>Time</b>	<b>Comments</b>
<b>Asparagus</b> (fresh spears)	1 lb.	6 to 9 min., Med-High (7)	In 1½-qt. oblong glass baking dish, place 1/4 cup water.
(frozen spears)	10-oz. package	5 to 7 min.	In 1-qt. casserole.
<b>Beans</b> (fresh green)	1 lb. cut in half	9 to 11 min.	In 1½-qt. casserole, place 1/2 cup water.
(frozen green)	10-oz. package	6 to 8 min.	In 1-qt. casserole, place 2 tablespoons water.
(frozen lima)	10-oz. package	6 to 8 min.	In 1-qt. casserole, place 1/4 cup water.
<b>Beets</b> (fresh, whole)	1 bunch	17 to 21 min.	In 2-qt. casserole, place 1/2 cup water.
<b>Broccoli</b> (fresh cut)	1 bunch (1¼ to 1½ lbs.)	7 to 10 min.	In 2-qt. casserole, place 1/2 cup water.
(fresh spears)	1 bunch (1¼ to 1½ lbs.)	9 to 13 min.	In 2-qt. oblong glass baking dish, place 1/4 cup water.
(frozen, chopped)	10-oz. package	5 to 7 min.	In 1-qt. casserole.
(frozen spears)	10-oz. package	5 to 7 min.	In 1-qt. casserole, place 3 tablespoons water.
<b>Cabbage</b> (fresh)	1 medium head (about 2 lbs.)	8 to 11 min.	In 1½- or 2-qt. casserole, place 1/4 cup water.
(wedges)		7 to 10 min.	In 2- or 3-qt. casserole, place 1/4 cup water.
<b>Carrots</b> (fresh, sliced)	1 lb.	7 to 9 min.	In 1½-qt. casserole, place 1/4 cup water.
(frozen)	10-oz. package	5 to 7 min.	In 1-qt. casserole, place 2 tablespoons water.
<b>Cauliflower</b> (flowerets)	1 medium head	9 to 14 min.	In 2-qt. casserole, place 1/2 cup water.
(fresh, whole)	1 medium head	10 to 17 min.	In 2-qt. casserole, place 1/2 cup water.
(frozen)	10-oz. package	5 to 7 min.	In 1-qt. casserole, place 2 tablespoons water.

<b>Vegetable</b>	<b>Amount</b>	<b>Time</b>	<b>Comments</b>
<b>Corn</b> (frozen kernel)	10-oz. package	5 to 7 min.	In 1-qt. casserole, place 2 tablespoons water.
<b>Corn on the cob</b> (fresh)	1 to 5 ears	3 to 4 min. per ear	In 2-qt. oblong glass baking dish, place corn. If corn is in husk, use no water; if corn has been husked, add 1/4 cup water. Rearrange after half of time.
(frozen)	1 ear 2 to 6 ears	5 to 6 min. 3 to 4 min. per ear	Place in 2-qt. oblong glass baking dish. Cover with vented plastic wrap. Rearrange after half of time.
<b>Mixed vegetables</b> (frozen)	10-oz. package	5 to 7 min.	In 1-qt. casserole, place 3 tablespoons water.
<b>Peas</b> (fresh, shelled)	2 lbs. unshelled	9 to 12 min.	In 1-qt. casserole, place 1/4 cup water.
(frozen)	10-oz. package	5 to 7 min.	In 1-qt. casserole, place 2 tablespoons water.
<b>Potatoes</b> (fresh, cubed, white)	4 potatoes (6 to 8 oz. each)	9 to 12 min.	Peel and cut into 1 inch cubes. Place in 2-qt. casserole with 1/2 cup water. Stir after half of time.
(fresh, whole, sweet or white)	1 (6 to 8 oz.)	3 to 4 min.	Pierce with cooking fork. Place in center of the oven. Let stand 5 minutes.
<b>Spinach</b> (fresh)	10 to 16 oz.	5 to 7 min.	In 2-qt. casserole, place washed spinach.
(frozen, chopped and leaf)	10-oz. package	5 to 7 min.	In 1-qt. casserole, place 3 tablespoons water.
<b>Squash</b> (fresh, summer and yellow)	1 lb. sliced	5 to 7 min.	In 1½-qt. casserole, place 1/4 cup water.
(winter, acorn butternut)	1 to 2 squash (about 1 lb. each)	8 to 11 min.	Cut in half and remove fibrous membranes. In 2-qt. oblong glass baking dish, place squash cut-side-down. Turn cut-side-up after 4 minutes.

## Time Defrost

**Defrost  
Auto/Time**

*Express Cook*

**1 2 3**  
**4 5 6**

**7 8 9**

**0**  
**DISPLAY**

1. Press **DEFROST AUTO/TIME** twice.
2. Enter defrosting time.
3. Press **START**.
4. Turn food over when the oven signals.
5. Press **START**. (Auto Defrost explained in the section on Convenience Features).

Allows you to defrost for the length of time you select. See the Defrosting Guide for suggested times.

Power level 3 is automatically set, but you may change this for more flexibility. You may defrost small items more quickly by raising the power level after entering the time. However, they will need more frequent attention than usual.

Power level 7 cuts the total defrosting time in about half; power level 10 cuts the total time to approximately 1/3. Rotate or stir food frequently.

At one half of selected defrosting time, the oven signals TURN. At this time, turn food over and break apart or rearrange pieces for more even defrosting. Shield any warm areas with small pieces of foil.

A dull thumping noise may be heard during defrosting. This sound is normal when the oven is not operating at High power.

### **Defrosting Tips**

- Foods frozen in paper or plastic can be defrosted in the package. Tightly closed packages should be slit, pierced or vented AFTER food has partially defrosted. Plastic storage containers should be at least partially uncovered.
- Family-size, prepackaged frozen dinners can be defrosted and microwaved. If the food is in a foil container, transfer it to a microwave-safe dish.
- Foods that spoil easily, such as milk, eggs, fish, stuffings, poultry and pork, should not be allowed to sit out for more than one hour after defrosting. Room temperature promotes the growth of harmful bacteria.
- For more even defrosting of larger foods, such as beef, lamb and veal roasts, use Auto Defrost.
- Be sure large meats are completely defrosted before cooking.
- When defrosted, food should be cool but softened in all areas. If still slightly icy, return to the microwave very briefly, or let it stand a few minutes.

### **Defrosting Guide**

<b>Food</b>	<b>Time</b>	<b>Comments</b>
<b>Breads, Cakes</b> <b>Bread, buns or rolls</b> (1 piece) <b>Sweet rolls</b> (approx. 12 oz.)	1 min. 3 to 5 min.	
<b>Fish and Seafood</b> <b>Fillets, frozen</b> (1 lb.) <b>Shellfish, small pieces</b> (1 lb.)	6 to 8 min. 5 to 7 min.	Place block in casserole. Turn over and break up after half the time.
<b>Fruit</b> <b>Plastic pouch—1 to 2</b> (10-oz. package)	3 to 6 min.	
<b>Meat</b> <b>Bacon</b> (1 lb.)  <b>Franks</b> (1 lb.)  <b>Ground meat</b> (1 lb.) <b>Roast: beef, lamb, veal, pork</b>  <b>Steaks, chops and cutlets</b>	2 to 5 min.  2 to 5 min.  5 to 7 min. 12 to 16 min. per lb. 5 to 7 min. per lb.	Place unopened package in oven. Let stand 5 minutes after defrosting. Place unopened package in oven. Microwave just until franks can be separated. Let stand 5 minutes, if necessary, to complete defrosting. Turn meat over after half the time. Use power level 1. Place unwrapped meat in cooking dish. Turn over after half the time and shield warm areas with foil. When finished, separate pieces and let stand to complete defrosting.
<b>Poultry</b> <b>Chicken, broiler-fryer cut up</b> (2½ to 3 lbs.)  <b>Chicken, whole</b> (2½ to 3 lbs.)  <b>Cornish hen</b>  <b>Turkey breast</b> (4 to 6 lbs.)	15 to 19 min.  17 to 21 min.  7 to 13 min. per lb.  5 to 9 min. per lb.	Place wrapped chicken in dish. Unwrap and turn over after half the time. When finished, separate pieces and microwave 2–4 minutes more, if necessary. Let stand to finish defrosting. Place wrapped chicken in dish. After half the time, unwrap and turn chicken over. Shield warm areas with foil. Finish defrosting. If necessary, run cold water in the cavity until giblets can be removed. Place unwrapped hen in the oven breast-side-up. Turn over after half the time. Run cool water in the cavity until giblets can be removed. Place unwrapped breast in dish breast-side-down. After half the time, turn over and shield warm areas with foil. Finish defrosting. Let stand 1–2 hours in refrigerator to complete defrosting.

18

Express Cook



**This is a quick way to set cooking time for 1–6 minutes.**

Press one of the Express Cook pads (from 1 to 6) for 1 to 6 minutes of cooking at power level 10. For example, press the 2 pad for 2 minutes of cooking time.

The power level can be changed as time is counting down. Press POWER LEVEL and enter 1–10.

### **Add 30 Seconds**



**You can use this feature two ways:**

- It will add 30 seconds to the time counting down each time the pad is pressed.
- It can be used as a quick way to set 30 seconds of cooking time.

## **Convenience Features**

### **Popcorn**



Use only with  
prepackaged microwave  
popcorn weighing  
3.0 to 3.5 ounces.

**NOTE:** Do not use the metal shelf when cooking popcorn.

**How to Use the Popcorn Feature**

1. Follow package instructions, using Time Cook if the package is less than 3.0 ounces or larger than 3.5 ounces. Place the package of popcorn in the center of the microwave.
2. Press POPCORN. The oven starts immediately. Tap POPCORN to select the bag size you are cooking.

**Beverage**



The Beverage feature heats servings of any beverage.

Press BEVERAGE. The oven starts immediately.

**On some models**, the serving size is automatically set at 1, but can be changed by pressing 2 or 3 right after pressing BEVERAGE.

**Drinks heated with the Beverage feature may be very hot. Remove the container with care.**

**Reheat**

A large, rounded rectangular button with a double-line border. The word "Reheat" is centered in a bold, black, sans-serif font.

Reheat

2

3

A large, rounded rectangular button with a double-line border. The word "Start" is positioned above a horizontal line, and the word "Pause" is positioned below the line. Both words are in a bold, black, sans-serif font.

Start  
Pause

**NOTE:** Do not use the metal shelf when using the Reheat feature.

The Reheat feature reheats servings of many previously cooked foods.

1. Press REHEAT.
2. Select food type 1–6 for one serving (see Reheat Guide below). On some models, the oven starts immediately.

3. On some models, press START.
4. Press 2 or 3 to change the serving size.

**NOTE:** The serving size may be changed or added after the oven starts. Press number pad 2 or 3. On some models, the serving size for food type 6 cannot be changed.

### Reheat Guide

<b>Food Type</b>	<b>Comments</b>
<b>1 Pasta</b>	Cover with lid or vented plastic wrap.
<b>2 Meats</b>	Cover with lid or vented plastic wrap.
<b>3 Veggies</b>	Cover with lid or vented plastic wrap.
<b>4 Beverages</b>	Works best with wide mouth mug—do not cover.
<b>5 Sauces</b>	Cover with lid or vented plastic wrap.
<b>6 Plate of leftovers</b>	Cover with vented plastic wrap.

### Potato

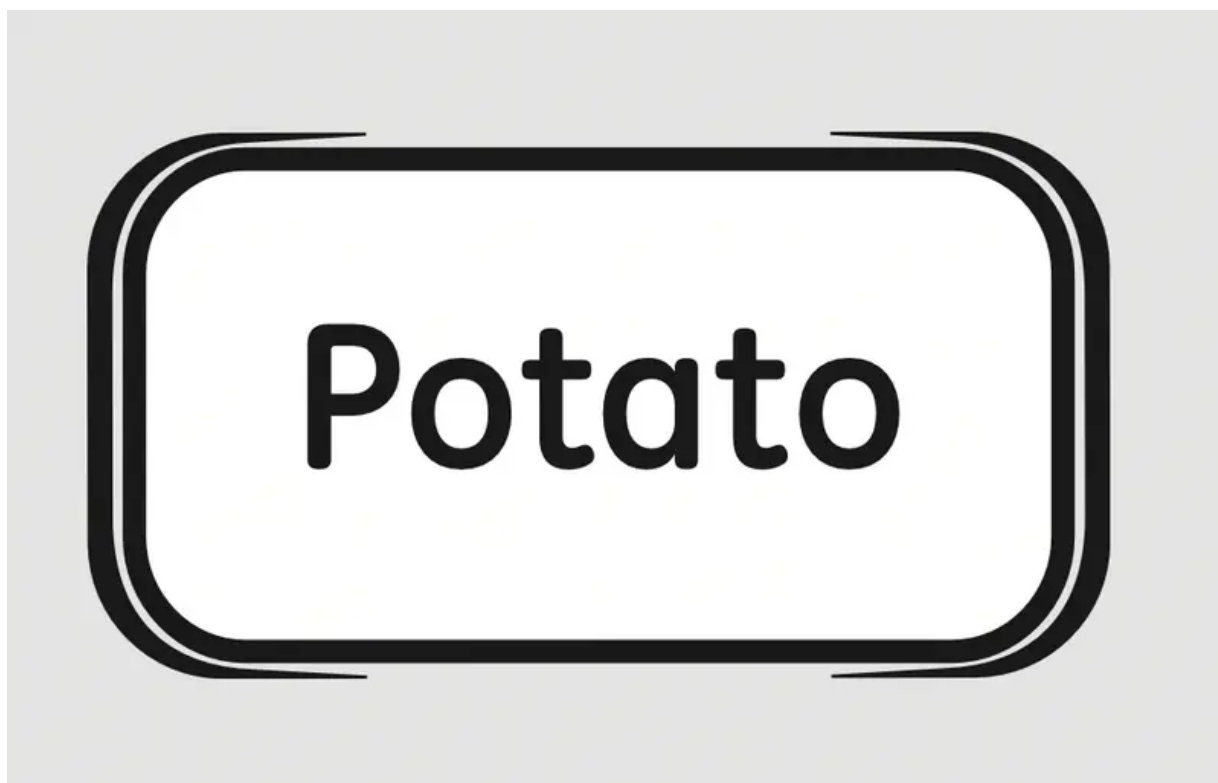

The Potato feature cooks up to four 8–10 ounce potatoes.

Press POTATO once for one potato, twice for two potatoes, three times for three potatoes and four times for four potatoes. The oven will start immediately after POTATO is pressed.

**Vegetable** (Model HVM1540 only)

**Vegetable**

*Express Cook*

**1**

**2**

**3**

**4**

**5**

**6**

**7**

**8**

**9**

**0**

**DISPLAY**

The Vegetable feature automatically sets the cooking times and power levels to cook fresh, frozen or canned vegetables.

1. Press VEGETABLE. "Select Veggie type 1–3" will be displayed.
2. Select food type 1–3 (see chart below).
3. Enter weight in ounces (see chart below).
4. The oven starts automatically.

<b><i>Food Code</i></b>	<b><i>Food</i></b>	<b><i>Weight</i></b>
<b>1</b>	Canned	4–20 oz.
<b>2</b>	Frozen	4–20 oz.
<b>3</b>	Fresh	4–16 oz.

#### Auto Defrost



**Defrost  
Auto/Time**

*Express Cook*

**1 2 3**  
**4 5 6**

**7 8 9**

**0**  
**DISPLAY**

1. Press DEFROST AUTO/TIME once.
2. Using the Conversion Guide at right, enter food weight. For example, press pads 1 and 2 for 1.2 pounds (1 pound, 3 ounces).
3. Press START. (Time Defrost is explained in the Time Features section.)

The Defrost Auto/Time feature gives you two ways to defrost frozen foods. Press DEFROST AUTO/TIME once for Auto Defrost or twice for Time Defrost.

Use Auto Defrost for meat, poultry and fish. Use Time Defrost for most other frozen foods.

Auto Defrost automatically sets the defrosting times and power levels to give even defrosting results for meats, poultry and fish weighing up to six pounds.

There is a handy guide located on the inside front of the oven.

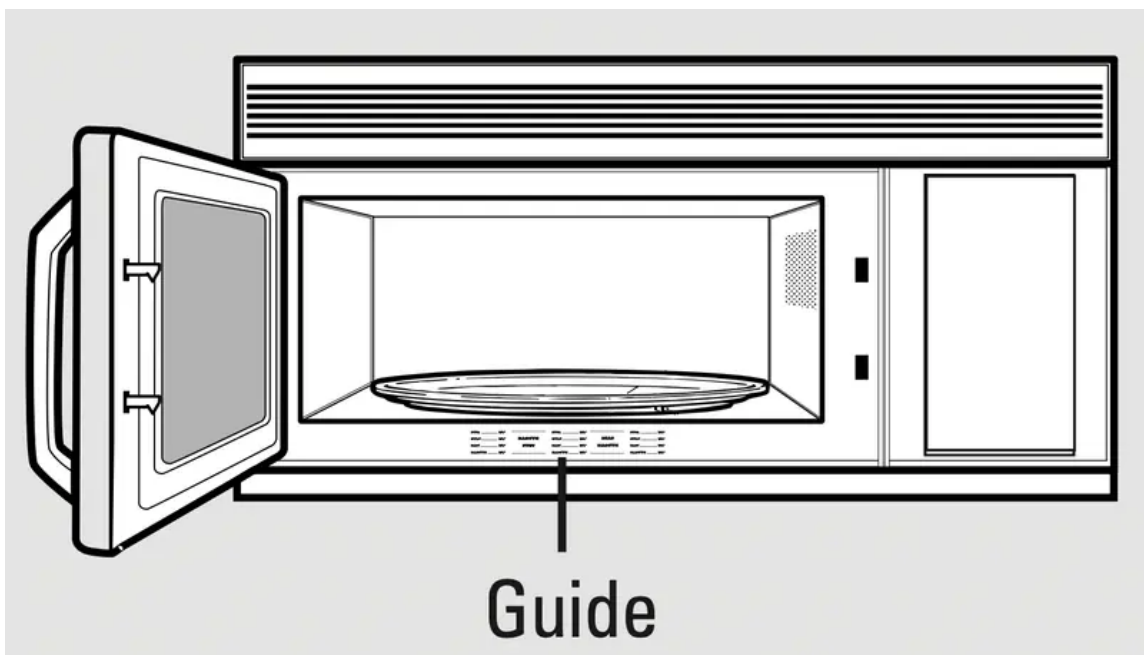

### **Conversion Guide**

If the weight of food is stated in pounds and ounces, the ounces must be converted to tenths (.1) of a pound.

<b><i>Weight of Food in Ounces</i></b>	<b><i>Enter Food Weight (tenths of a pound)</i></b>
1–2	.1
3	.2
4–5	.3
6–7	.4
8	.5
9–10	.6
11	.7
12–13	.8
14–15	.9

- Remove meat from package and place on microwave-safe dish.
- Twice during defrost, the oven signals TURN. At each TURN signal, turn the food over. Remove defrosted meat or shield warm areas with small pieces of foil.
- After defrosting, most meats need to stand 5 minutes to complete defrosting. Large roasts should stand for about 30 minutes.

## **Other Features Your Model May Have**

### **Cooking Complete Reminder**

To remind you that you have food in the oven, the oven will display “FOOD IS READY” or “END” and beep once a minute until you either open the oven door or press CLEAR/OFF.

### **Clock**

**Clock**

*Express Cook*

**1**

**2**

**3**

**4**

**5**

**6**

**7**

**8**

**9**

**0**

**DISPLAY**

Press to enter the time of day or to check the time of day while microwaving.

1. Press CLOCK.
2. Enter time of day.
3. On some models, select AM or PM.
4. Press START or CLOCK.

### **Scroll Speed (On some models)**

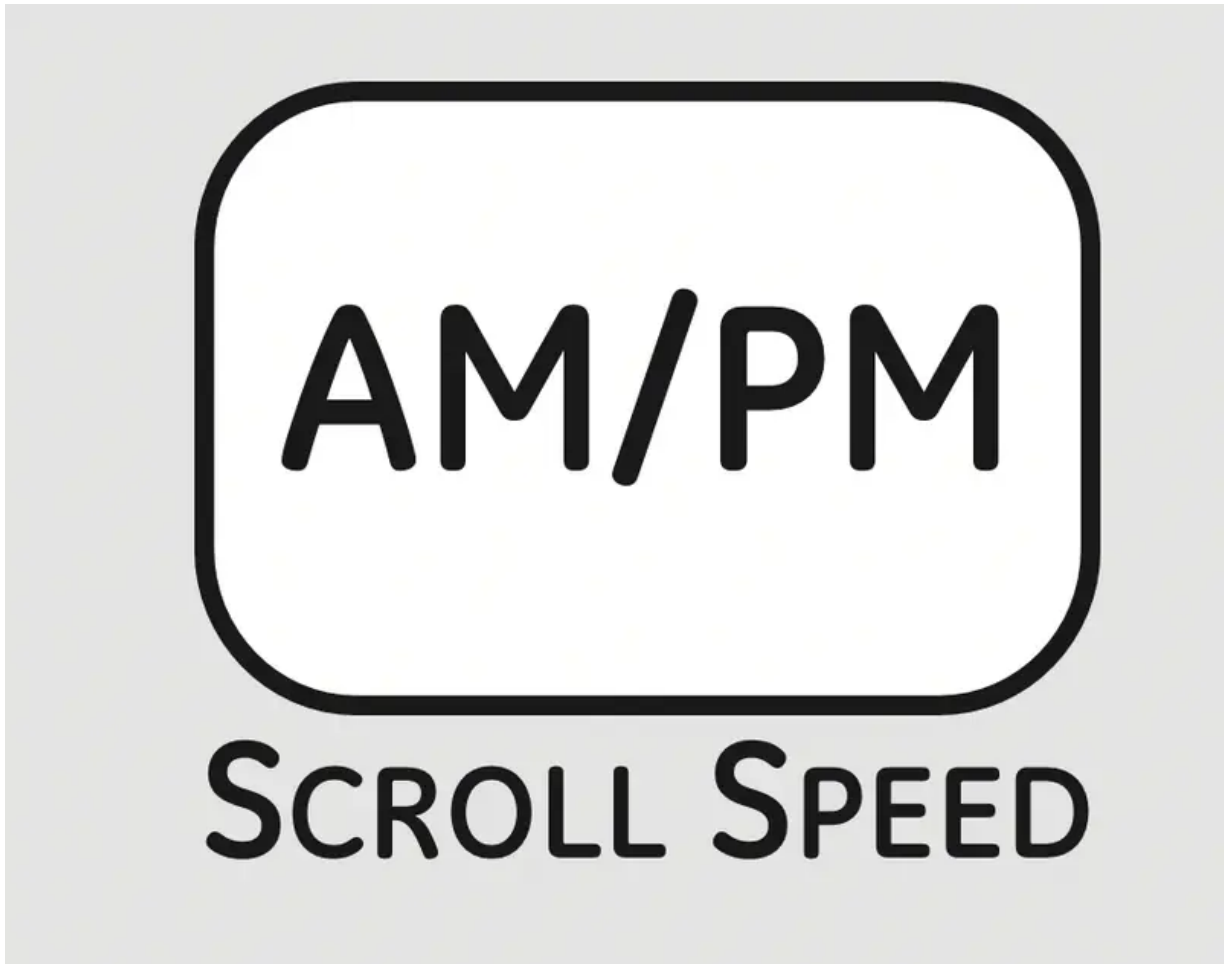

The scroll speed of the display can be changed. Press and hold the AM/PM pad about 3 seconds to bring up the display.

Select 1–5 for slow to fast scroll speed.

### **Display On/Off**



0  
DISPLAY

To turn the clock display off, press and hold 0 for about three seconds.

To redisplay the clock, repeat.

### **Delay Start**

**Delay  
Start**

*Express Cook*

**1 2 3**  
**4 5 6**

**7 8 9**

**0**  
**DISPLAY**



Delay Start allows you to set the microwave to delay cooking up to 24 hours.

1. Press DELAY START.
2. Enter the time you want the oven to start. (Be sure the microwave clock shows the correct time of day.)
3. On some models, select AM or PM.
4. Select any combination of Defrost Auto/Time or Time Cook I & II.
5. Press START.

The Delay Start time will be displayed. The oven will automatically start at the delayed time.

The time of day may be displayed by pressing CLOCK.

### **Timer On/Off**

**Timer  
On/Off**

*Express Cook*

**1 2 3**  
**4 5 6**

**7 8 9**

**0**  
**DISPLAY**



Timer On/Off operates as a minute timer and can be used at any time, even when the oven is operating.

1. Press TIMER ON/OFF.
2. Enter time you want to count down.
3. Press TIMER ON/OFF to start.

When time is up, the oven will signal. To turn off the timer signal, press TIMER ON/OFF.

**NOTE:** The timer indicator will be lit while the timer is operating.

### Start/Pause

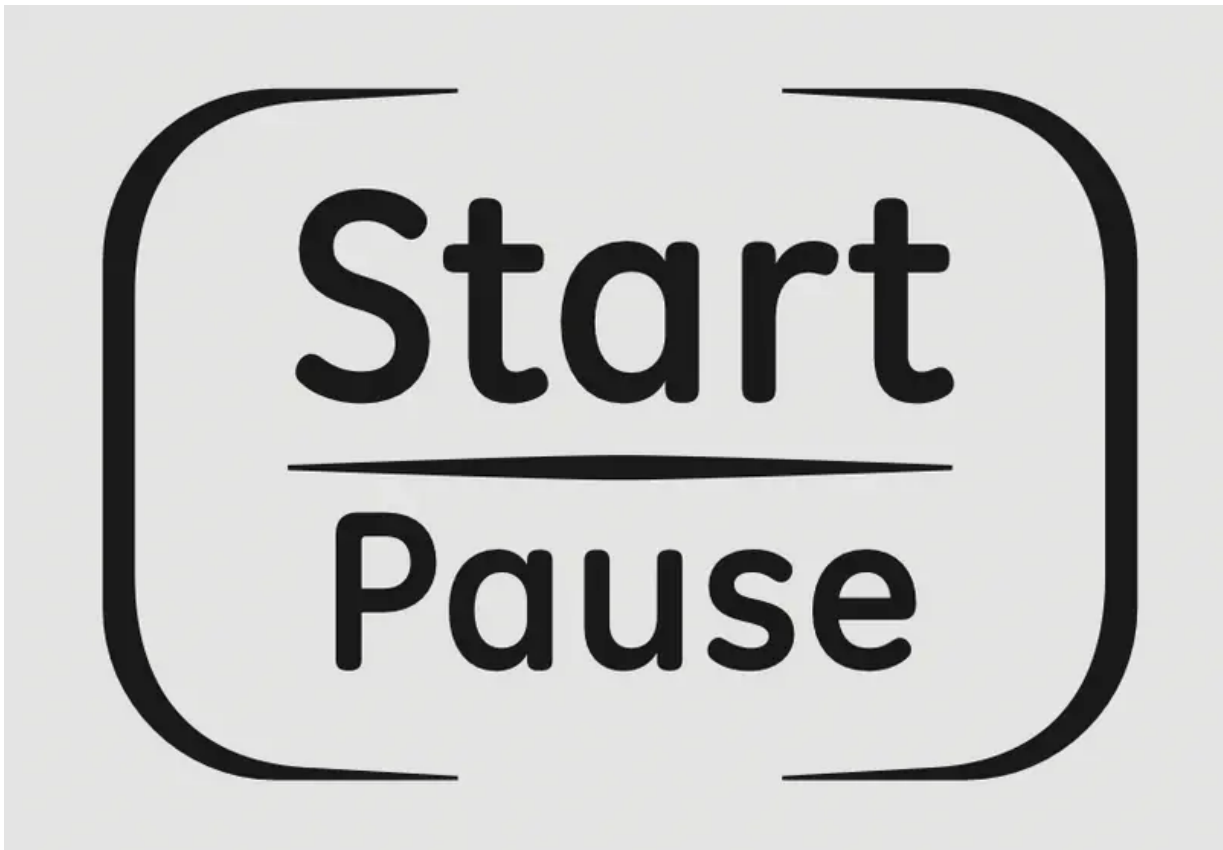

In addition to starting many functions, START/PAUSE allows you to stop cooking without opening the door or clearing the display.

### Reminder

Reminder

*Express Cook*

1 2 3  
4 5 6

7 8 9

0

DISPLAY

AM/PM

The Reminder feature can be used like an alarm clock and can be used at any time, even when the oven is operating. The Reminder time can be set up to 24 hours later.

1. Press REMINDER.
2. Enter the time you want the oven to remind you. (Be sure the microwave clock shows the correct time of day.)
3. On some models, select AM or PM.
4. Press REMINDER. When

Reminder signal occurs, press REMINDER to turn it off. The Reminder time may be displayed by pressing REMINDER.

**NOTE:** The REM indicator will remain lit to show that the Reminder is set. To clear the Reminder before it occurs, press REMINDER, then 0. The REM indicator will no longer be lit.

### Child Lock-Out



You may lock the control panel to prevent the microwave from being accidentally started or used by children.

To lock or unlock the controls, press and hold CLEAR/OFF for about 3 seconds. When the control panel is locked, "L" or "LOC" will be displayed to the extreme right.

### Turntable

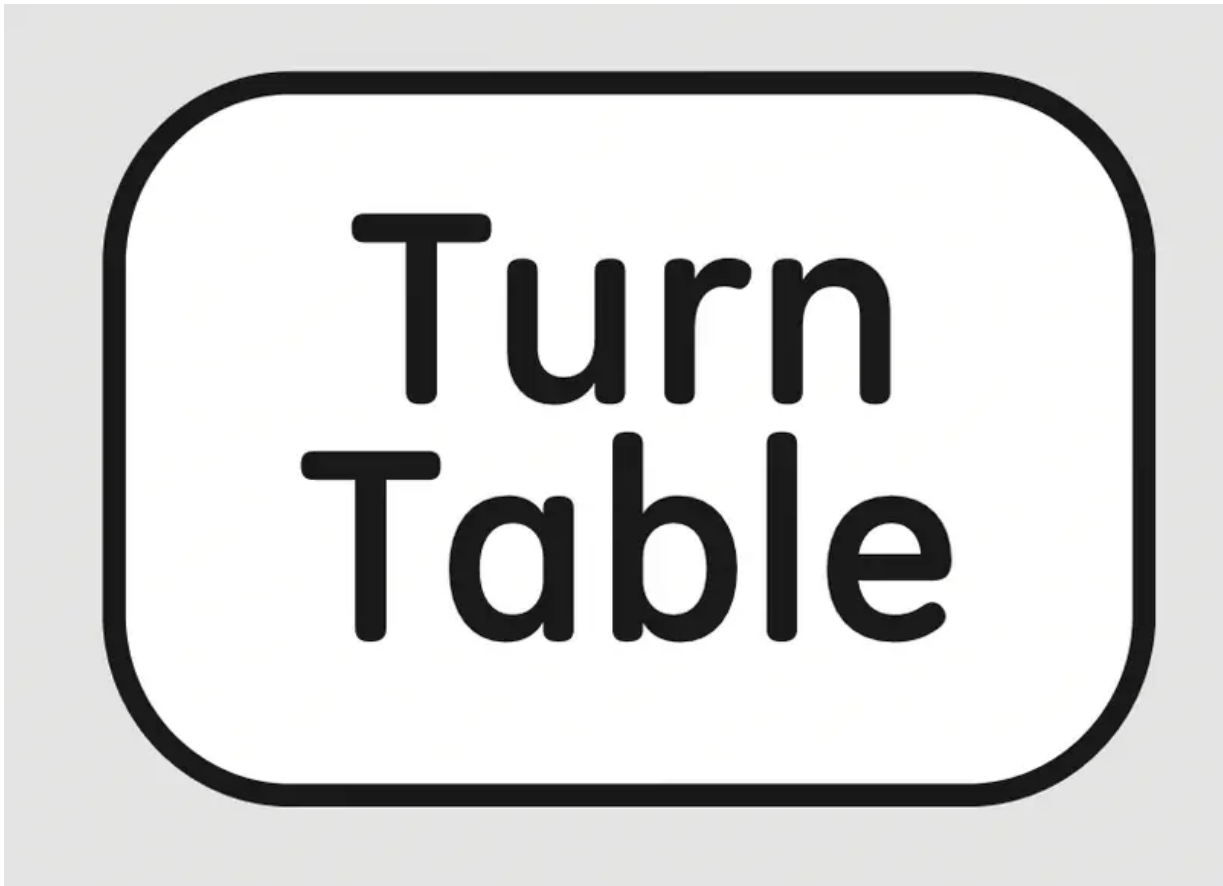

For best cooking results, leave the turntable on. It can be turned off for large dishes. Press TURNTABLE to turn the turntable on or off.

**Sometimes the turntable can become too hot to touch.** Be careful touching the turntable during and after cooking.

#### Surface Light



Press to turn the surface light on or off.

On some models, there is a night light option.

Press SURFACE LIGHT **once** for bright light, **twice** for the night light or **three** times to turn the light off.

## Vent Fan



When the microwave oven is off, you may operate the vent fan:

1. Press the Vent Fan pad once for high fan speed.
2. Press the Vent Fan pad a second time for low fan speed.
3. Press the Vent Fan pad a third time to turn the fan off.

When the microwave is on, the vent fan will automatically turn on at low fan speed, stay on while the microwave is operating and automatically turn off after the microwave goes off if the Vent Fan pad is not pressed.

When the microwave oven is on you may also:

1. Press the Vent Fan pad once for high fan speed.
2. Press the Vent Fan pad a second time for low fan speed.
3. Press the Vent Fan pad a third time to set the fan to turn off automatically after the microwave goes off.

If the vent fan is still operating after the microwave goes off, press the Vent Fan pad until it turns off.

**NOTE:** The vent fan cannot be turned off while the microwave is operating.

### Shelf (on some models)

#### How to Use the Shelf When Microwaving

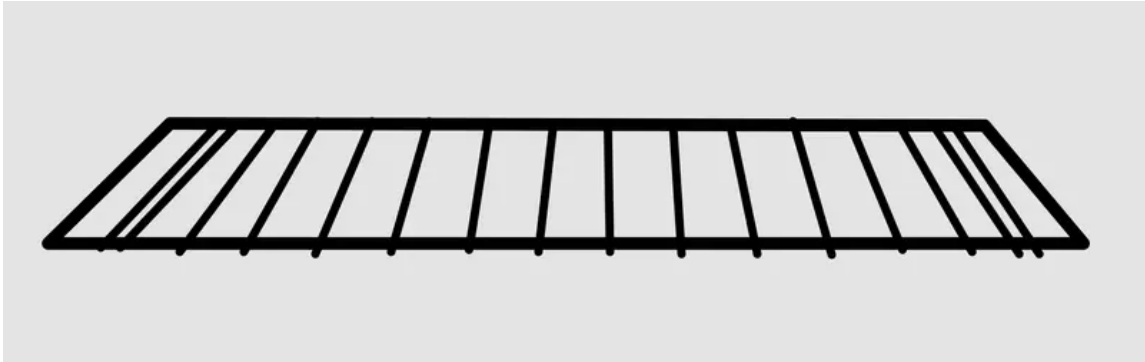

- Make sure the shelf is positioned properly inside the microwave to prevent damage to the oven from arcing.
- Do not use a microwave browning dish on the shelf. The shelf could overheat.
- Do not use the oven with the shelf on the microwave floor. This could damage the microwave.
- Use pot holders when handling the shelf it may be hot.
- Do not use the shelf when cooking popcorn.

Food microwaves best when placed on the turntable or on the shelf in the lower position.

**NOTE:** Only use the shelf when reheating on more than one level. Do not store the shelf inside the oven cavity.

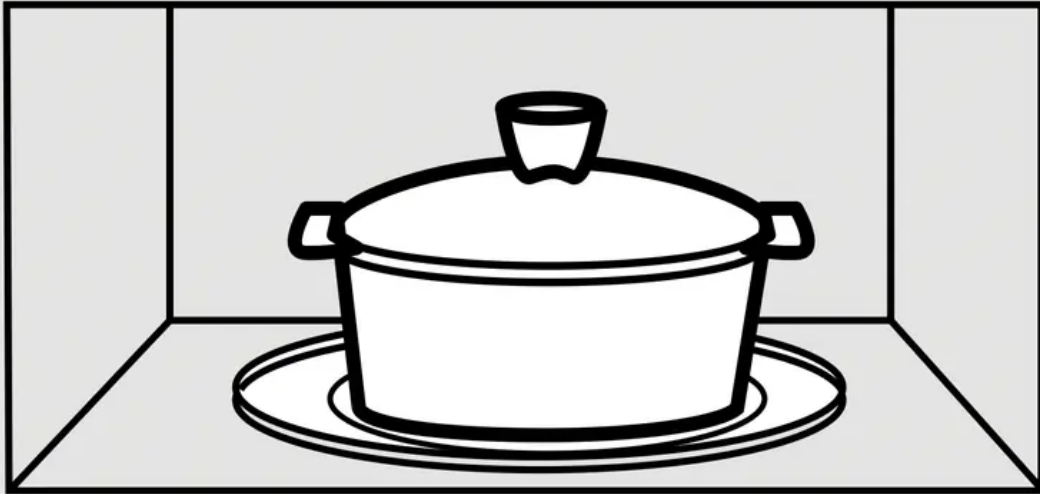

For best results

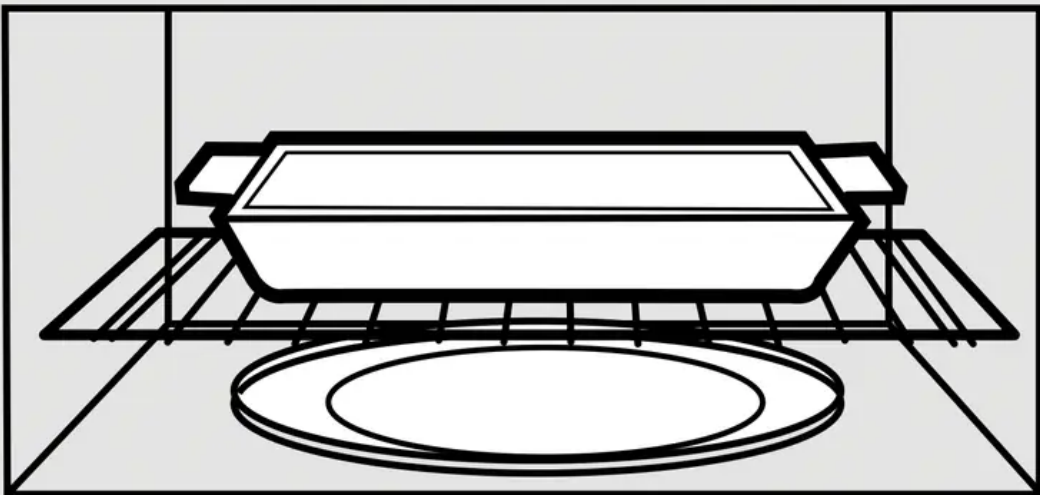

Use the lower shelf supports when cooking one oblong or oversized dish.

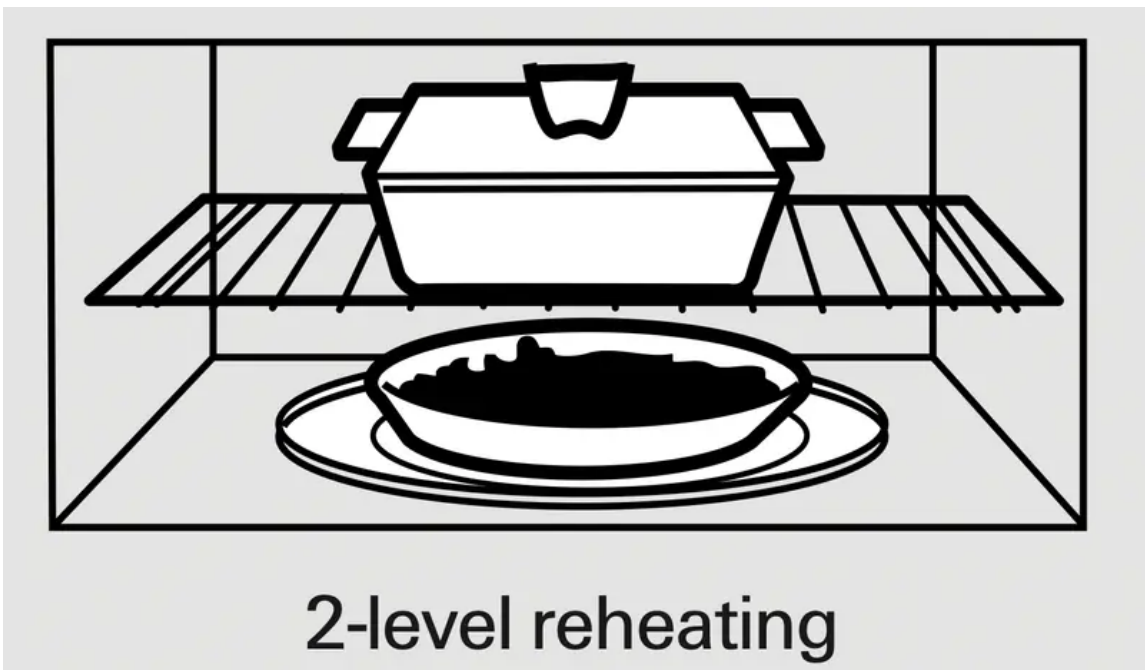
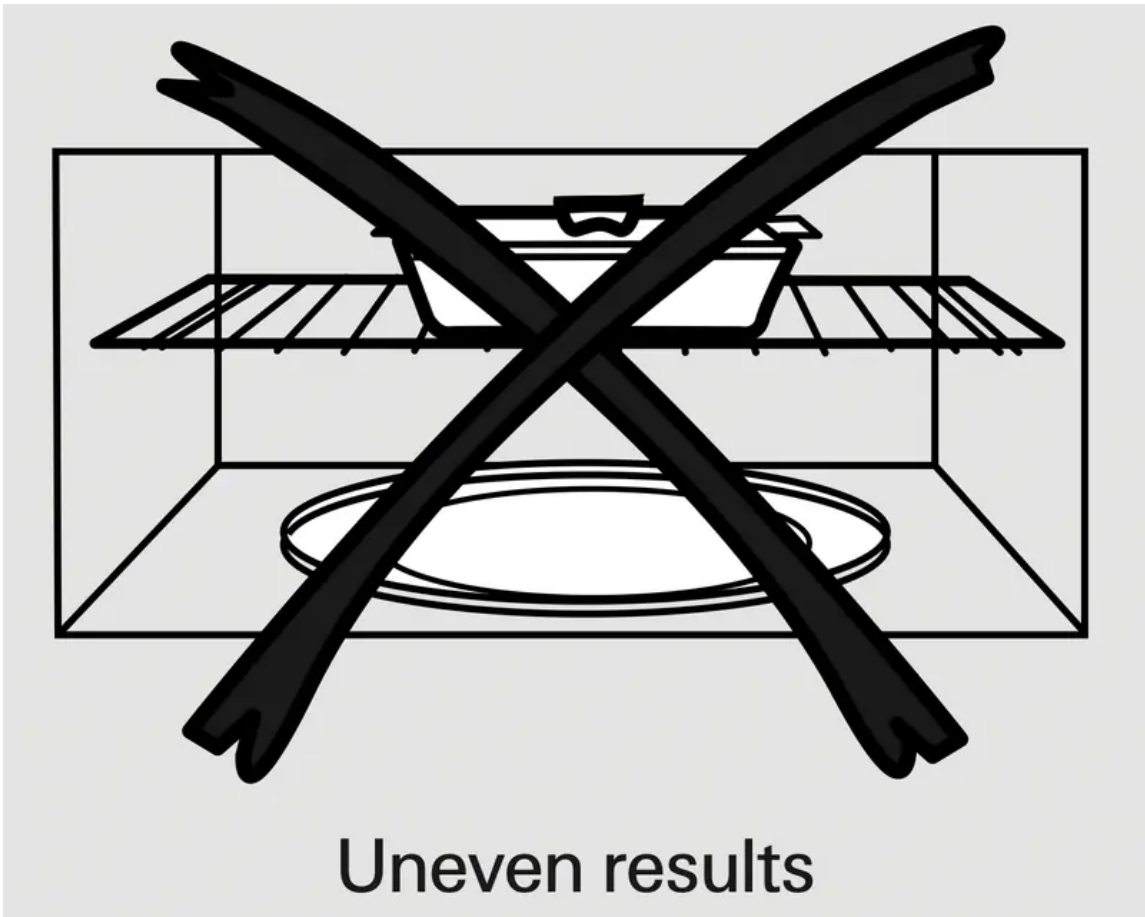

Use the upper shelf supports for two-level cooking.

### Shelf and Reheating

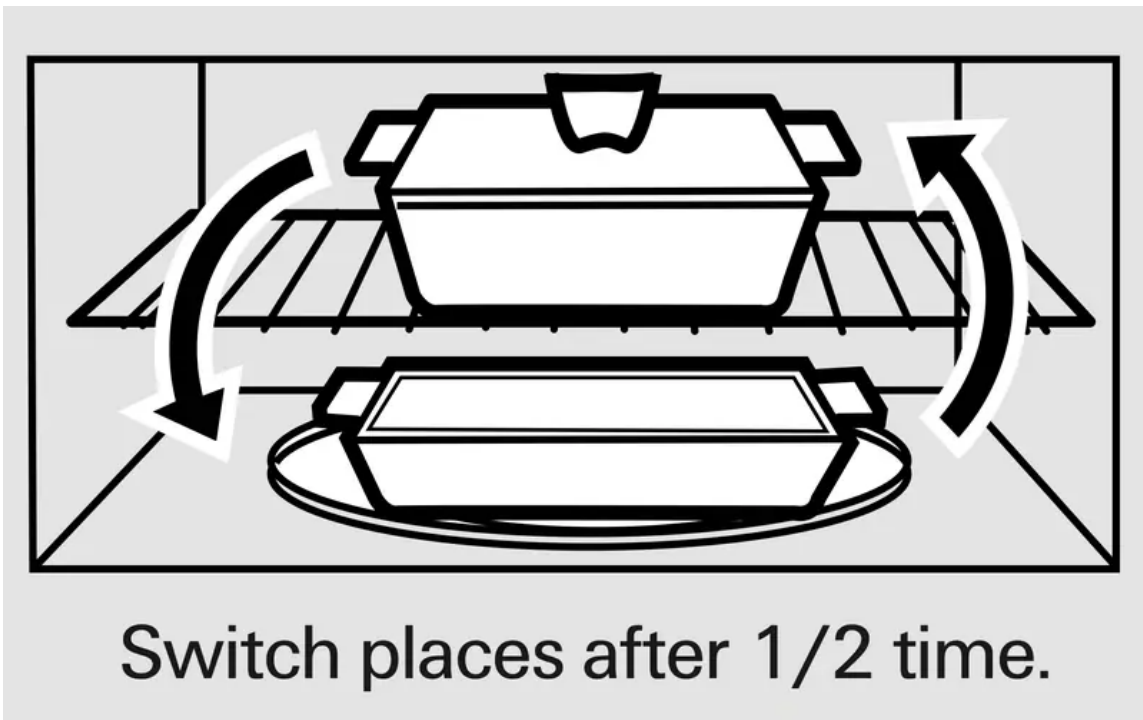

To reheat on 2 levels

or

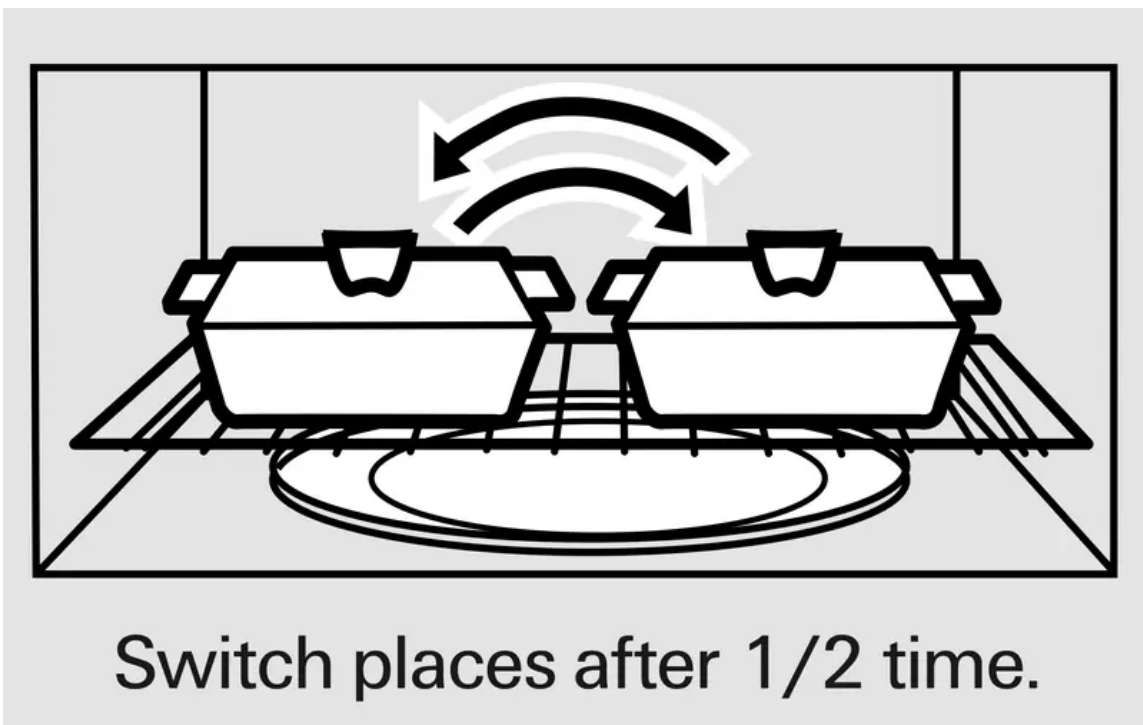

To reheat 2 dishes on the lower level:

1. Multiply reheat time by 1 1/2.
2. Switch places after 1/2 the time.

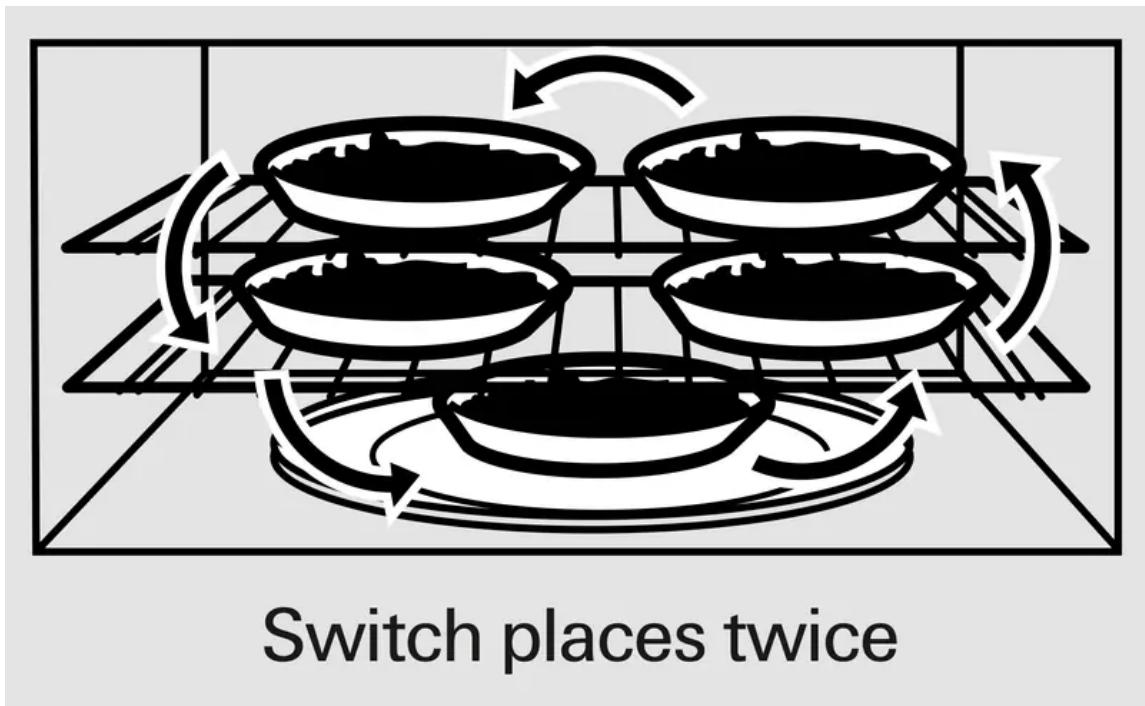

**To reheat on 3 levels (on some models)**

1. Double the reheating time.
2. Switch places twice and give the dishes a 1/2 turn during reheating. (Place dense foods, or those that require a longer cook time, on the upper shelf first.)

## Helpful Information

### Microwave Terms

Term	Definition
<b>Arcing</b>	Arcing is the microwave term for sparks in the oven. Arcing is caused by: <ul style="list-style-type: none"><li>• the metal shelf being installed incorrectly and touching the microwave walls.</li><li>• metal or foil touching the side of the oven.</li><li>• foil that is not molded to food (upturned edges act like antennas).</li><li>• metal such as twist ties, poultry pins, gold-rimmed dishes.</li><li>• recycled paper towels containing small metal pieces.</li></ul>
<b>Covering</b>	Covers hold in moisture, allow for more even heating and reduce cooking time. Venting plastic wrap or covering with wax paper allows excess steam to escape.
<b>Shielding</b>	In a regular oven, you shield chicken breasts or baked foods to prevent over-browning. When microwaving, you use small strips of foil to shield thin parts, such as the tips of wings and legs on poultry, which would cook before larger parts.
<b>Standing Time</b>	When you cook with regular ovens, foods such as roasts or cakes are allowed to stand to finish cooking or to set. Standing time is especially important in microwave cooking. Note that a microwaved cake is not placed on a cooling rack.
<b>Venting</b>	After covering a dish with plastic wrap, you vent the plastic wrap by turning back one corner so excess steam can escape.

## Care and Cleaning

### Helpful Hints



An occasional thorough wiping with a solution of baking soda and water keeps the inside fresh.

**NOTE:** Be certain the power is off before cleaning any part of this oven.

## How to Clean the Inside

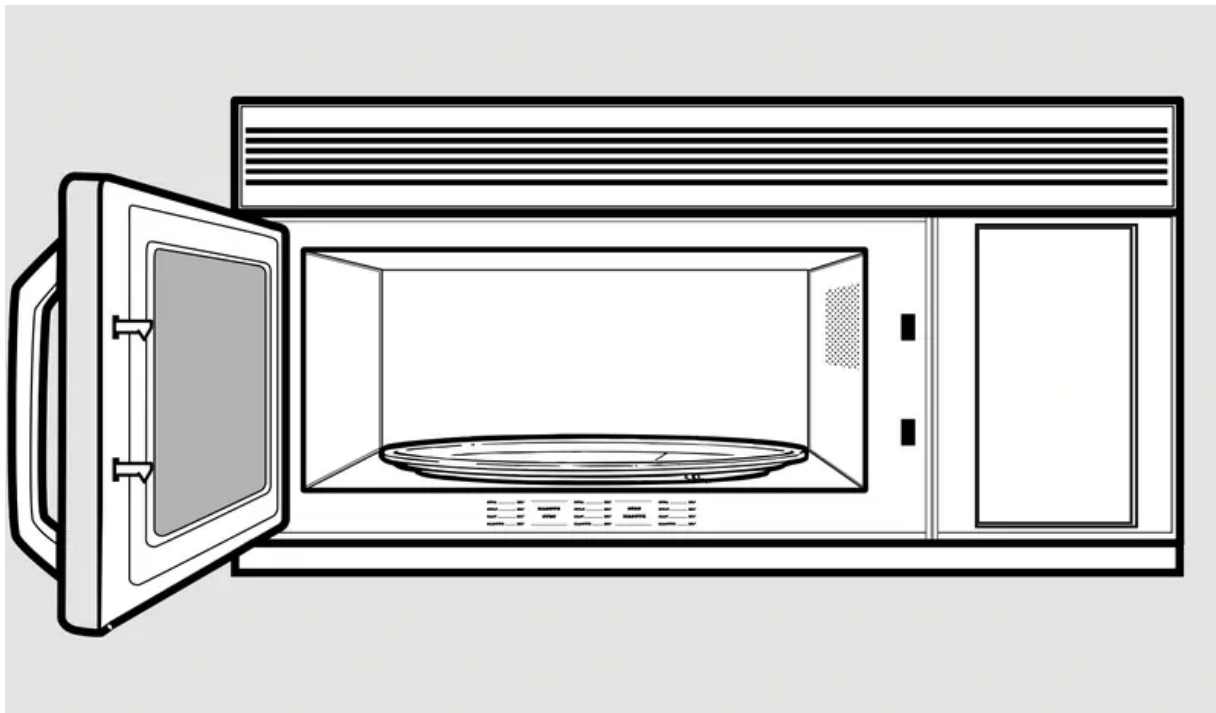

### **Walls, Floor, Inside Window, Metal and Plastic Parts on the Door**

Some spatters can be removed with a paper towel, others may require a damp cloth. Remove greasy spatters with a sudsy cloth, then rinse with a damp cloth. Do not use abrasive cleaners or sharp utensils on oven walls. Never use a commercial oven cleaner on any part of your microwave.

### **Temperature Probe (if included)**

Clean immediately after using. To clean, wipe with a sudsy cloth, then rub lightly with a plastic scouring ball if necessary. Rinse and dry. The probe can also be washed in the dishwasher.

### **Removable Turntable and Turntable Support**

To prevent breakage, do not place the turntable into water just after cooking. Wash it carefully in warm, sudsy water or in the dishwasher. The turntable and support can be broken if dropped. Remember, do not operate the oven without the turntable and support in place.

### **Shelf (if included)**

Clean with mild soap and water or in the dishwasher.

**Do not clean in a self-cleaning oven.**

## How to Clean the Outside

We recommend against using cleaners with ammonia or alcohol, as they can damage the appearance of the microwave oven. If you choose to use a common household cleaner, first apply the cleaner directly to a clean cloth, then wipe the soiled area.

### Case

Clean the outside of the microwave with a sudsy cloth. Rinse and then dry. Wipe the window clean with a damp cloth.

### Control Panel

Wipe with a damp cloth. Dry thoroughly. Do not use cleaning sprays, large amounts of soap and water, abrasives or sharp objects on the panel—they can damage it. Some paper towels can also scratch the control panel.

### Door Panel

Before cleaning the front door panel, make sure you know what type of panel you have. Refer to the eighth digit of the model number. "S" is stainless steel, "G" is Graphite, "L" is CleanSteel and "B", "W" or "C" are plastic colors.

### Stainless Steel

The stainless steel panel can be cleaned with Stainless Steel Magic or a similar product using a clean, soft cloth. Apply stainless cleaner carefully to avoid the surrounding plastic parts. Do not use appliance wax, polish, bleach or products containing chlorine on Stainless Steel finishes.

### CleanSteel or Graphite

Use a clean, soft, light and lightly dampened cloth, then dry thoroughly. Do not use appliance wax, polish, bleach or products containing any chemical agent on the CleanSteel or Graphite surfaces.

### Plastic Color Panels

Use a clean, soft, lightly dampened cloth, then dry thoroughly.

### Door Seal

It's important to keep the area clean where the door seals against the microwave. Use only mild, non-abrasive detergents applied with a clean sponge or soft cloth. Rinse well.

### Bottom

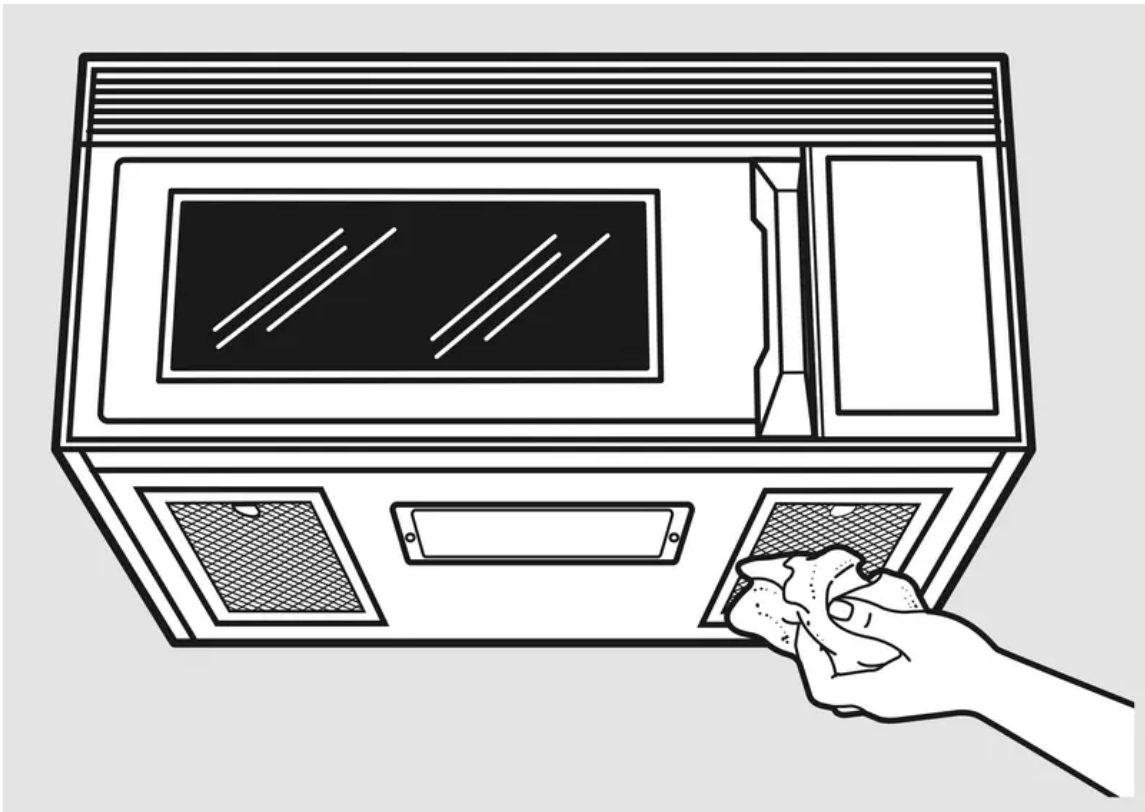

Clean off the grease and dust on the bottom often. Use a solution of warm water and detergent.

## Light Bulb Replacement

### Cooktop Light/ Night Light

Replace the burned-out bulb with a 30- or 40watt incandescent bulb (30-watt—WB36X10198/ 40-watt—WB36X10003), available from your GE supplier.

1. To replace the bulb(s), first disconnect the power at the main fuse or circuit breaker panel or pull the plug.
2. Remove the screw from light cover and lower the cover.

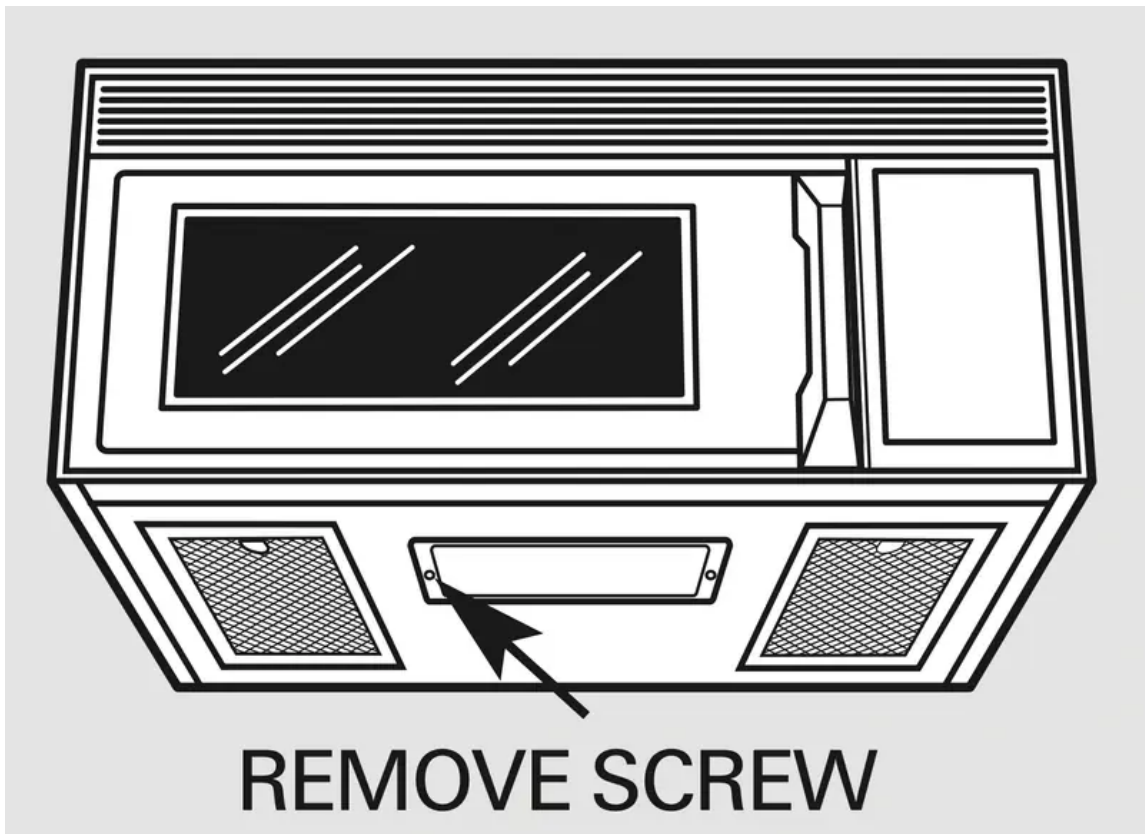

3. Be sure the bulb(s) to be replaced are cool before removing. After breaking the adhesive seal, remove the bulb by gently turning.
4. Replace the screw. Connect electrical power to the oven.

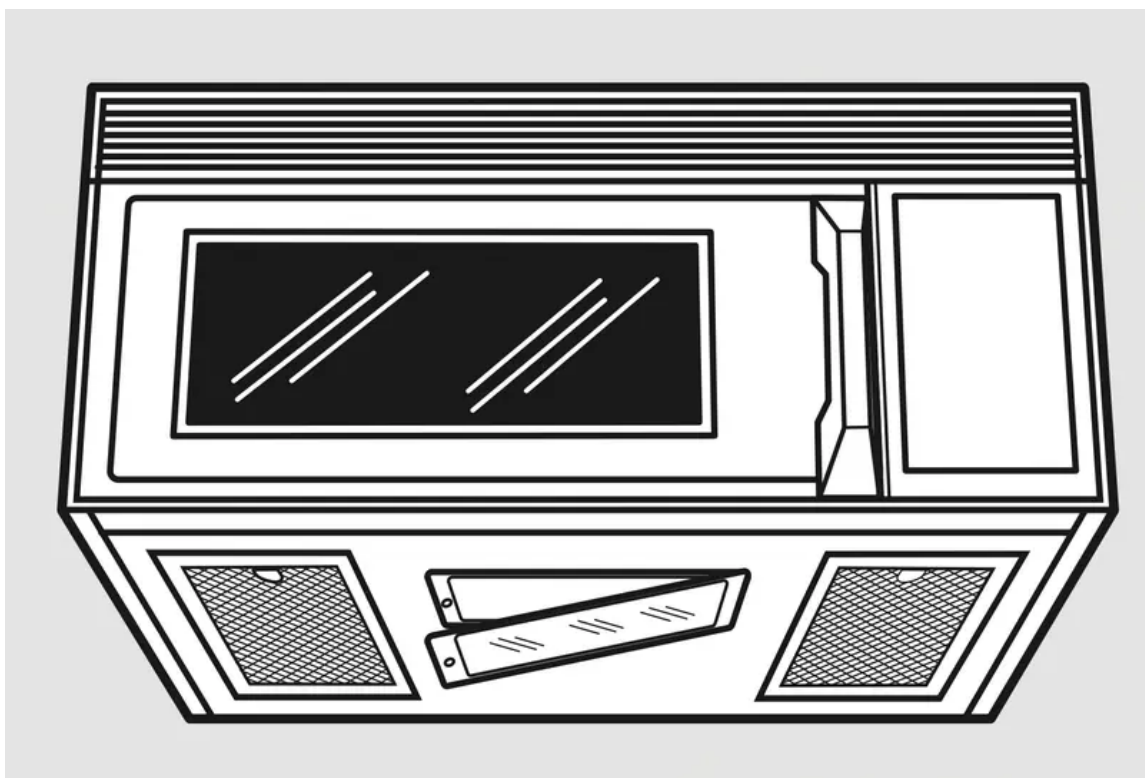

Oven Light

Replace the burned-out bulb with a 30- or 40watt incandescent bulb (30-watt—WB36X10198/ 40-watt—WB36X10003), available from your GE supplier.

1. To replace the oven light, first disconnect the power at the main fuse or circuit breaker panel or pull the plug.
2. Remove the top grille by taking out the 4 screws that hold it in place.

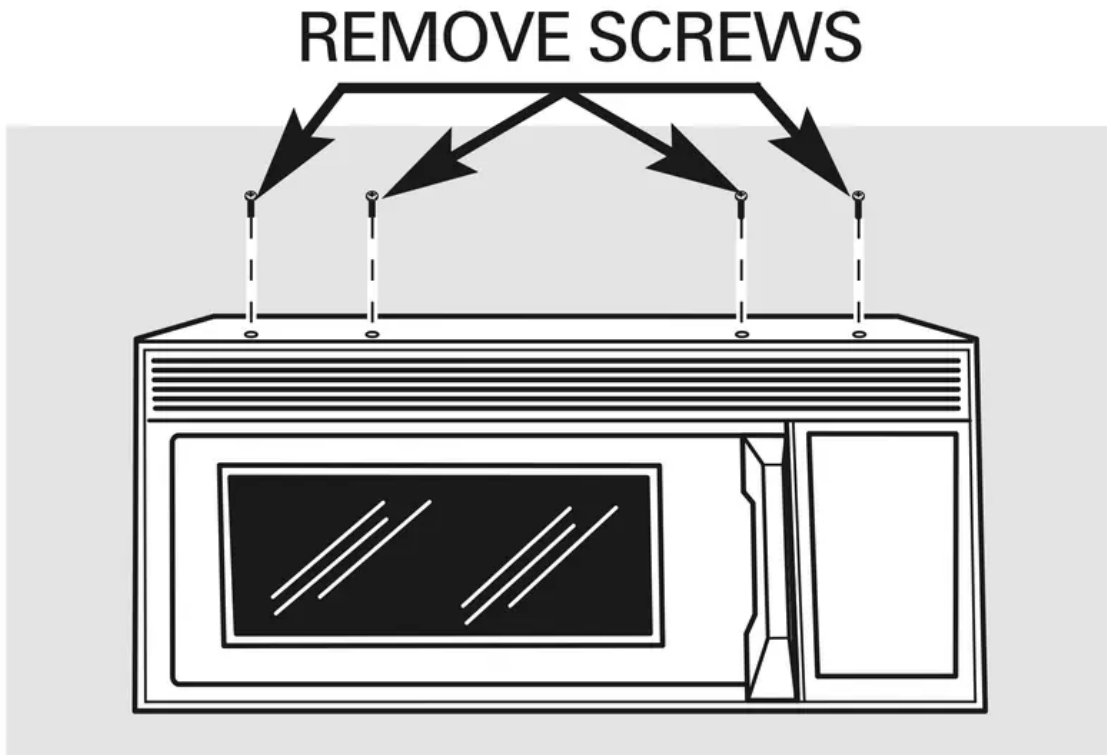

3. Push tab back and lift light housing. Replace the bulb and press the light housing back into place.

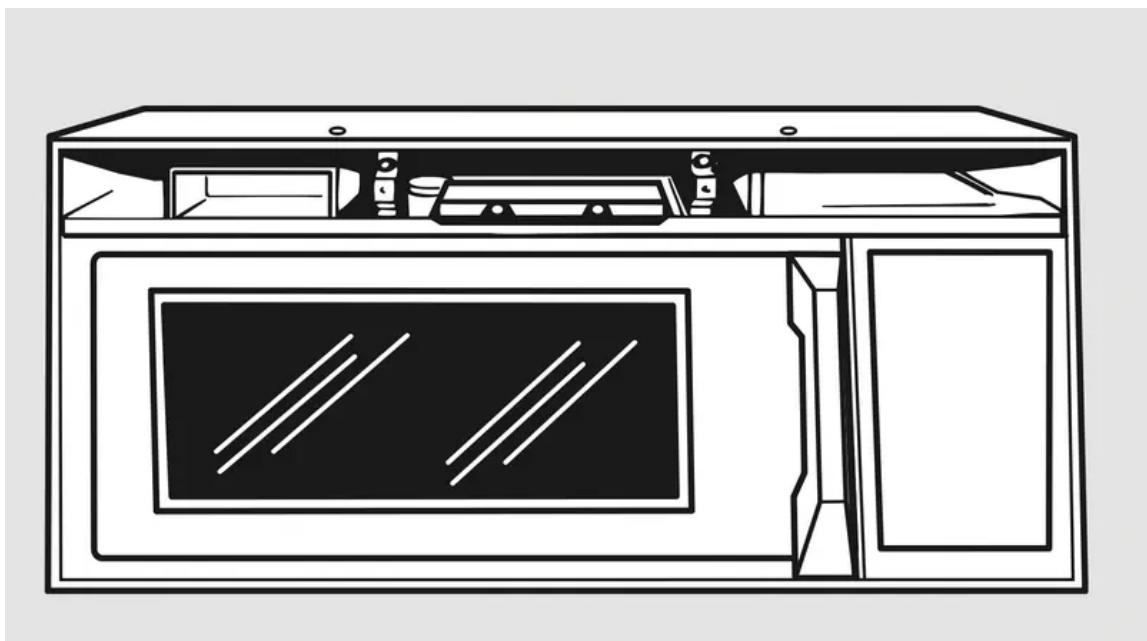

4. Replace the top grille and 4 screws. Connect electrical power to the oven.

## The Exhaust Feature

### The Vent Fan

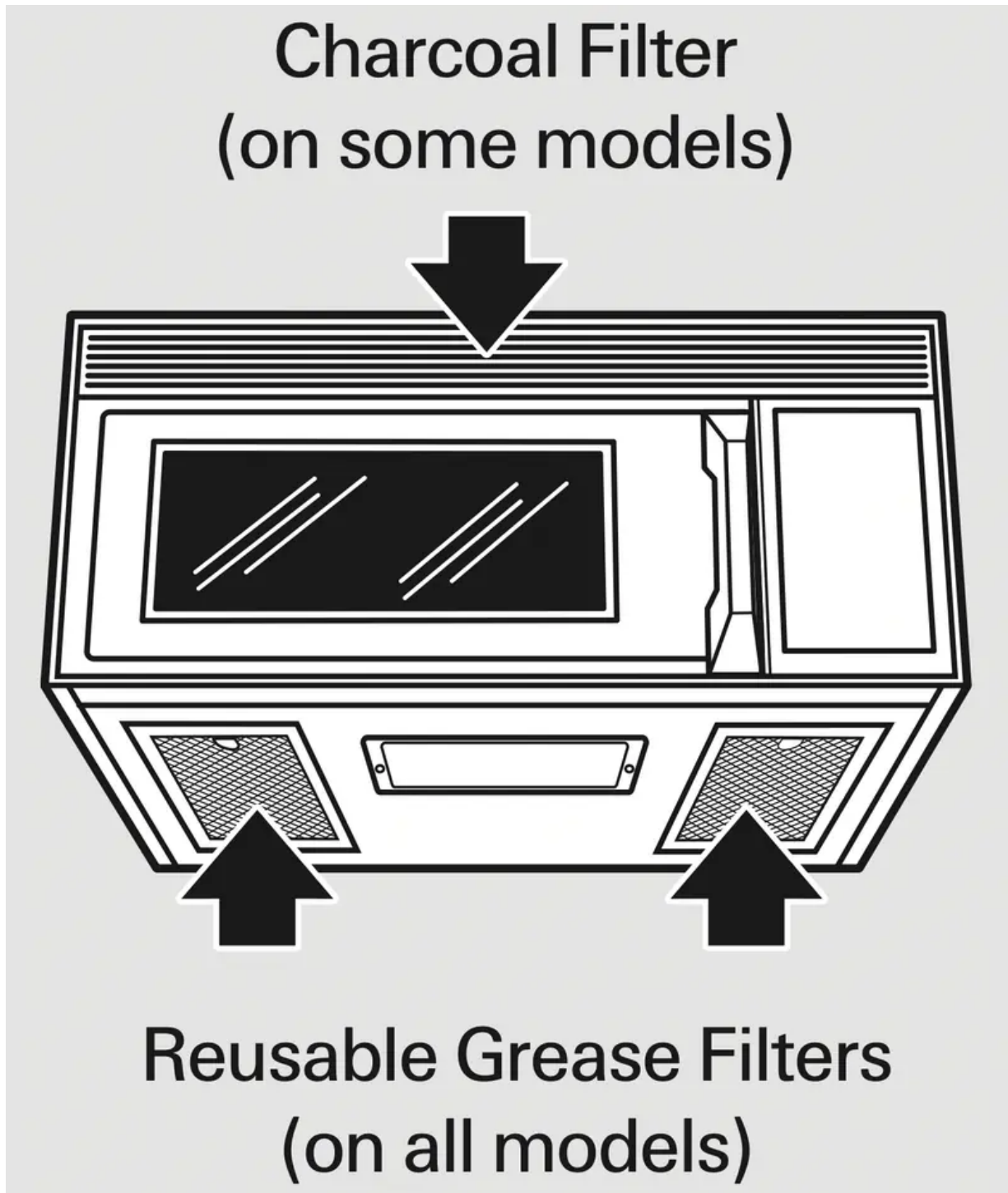

The vent fan has two metal reusable grease filters.

Models that recirculate air back into the room also use a charcoal filter.

### Reusable Grease Filters

The reusable grease filters trap grease released by foods on the cooktop. They also prevent flames from foods on the cooktop from damaging the inside of the microwave.

For this reason, the filters must ALWAYS be in place when the hood is used. The grease filters should be cleaned once a month, or as needed.

### Removing and Cleaning the Filter

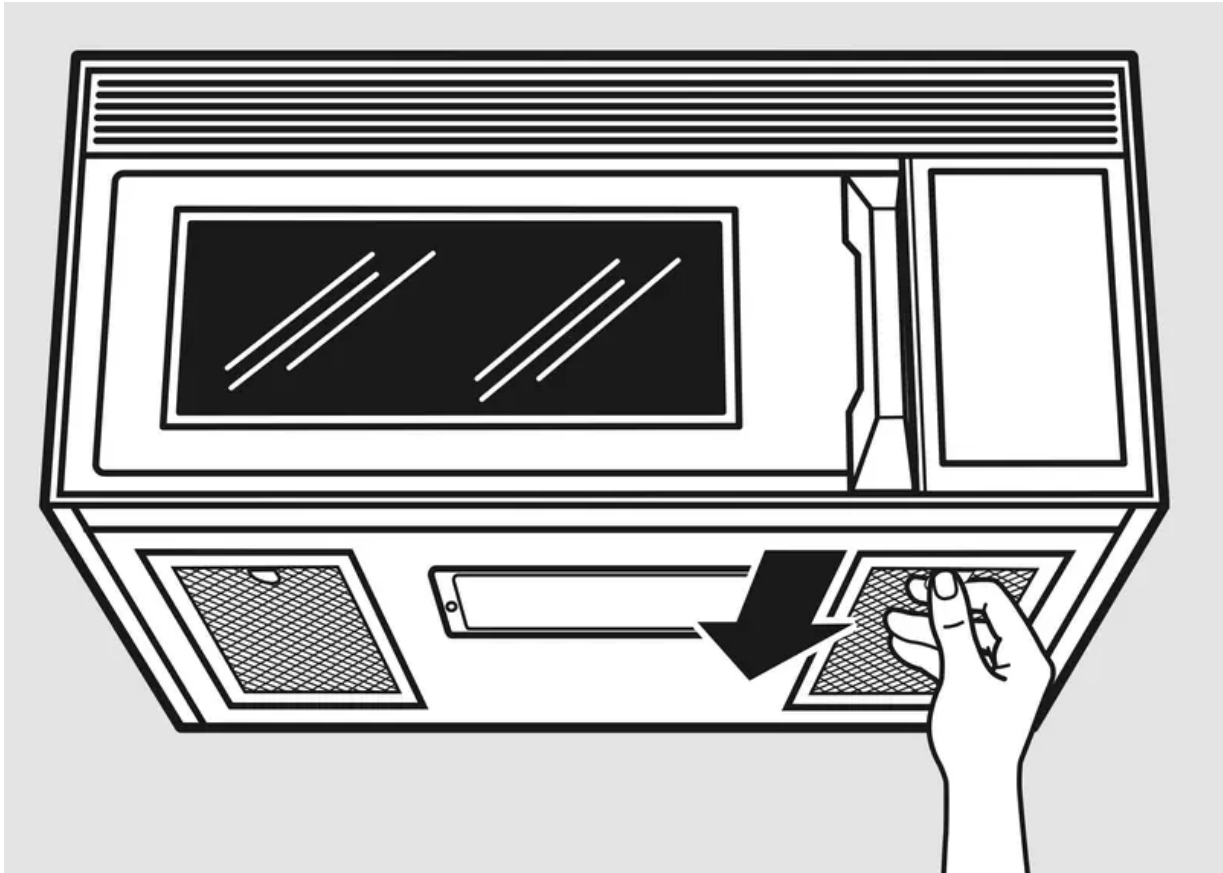

**To remove**, slide them to the side using the tab. Pull them down and out.

**To clean the grease filters**, soak them and then swish them around in hot water and detergent. Don't use ammonia or ammonia products because they will darken the metal. Light brushing can be used to remove embedded dirt.

Rinse, shake and let them dry before replacing.

**To replace**, slide the filters in the frame slot on the left side of the opening. Pull up and to the right to lock into place.

### Charcoal Filter (on some models)

**The charcoal filter cannot be cleaned. It must be replaced. Order Part No. WB02X10776 from your GE supplier.**

If the model is not vented to the outside, the air will be recirculated through a disposable charcoal filter that helps remove smoke and odors.

The charcoal filter should be replaced when it is noticeably dirty or discolored (usually after 6–12 months, depending on hood usage). See "Optional Kits," page 9 for more information.

### To Remove Charcoal Filter

Remove 4 grille screws to  
remove the grille.

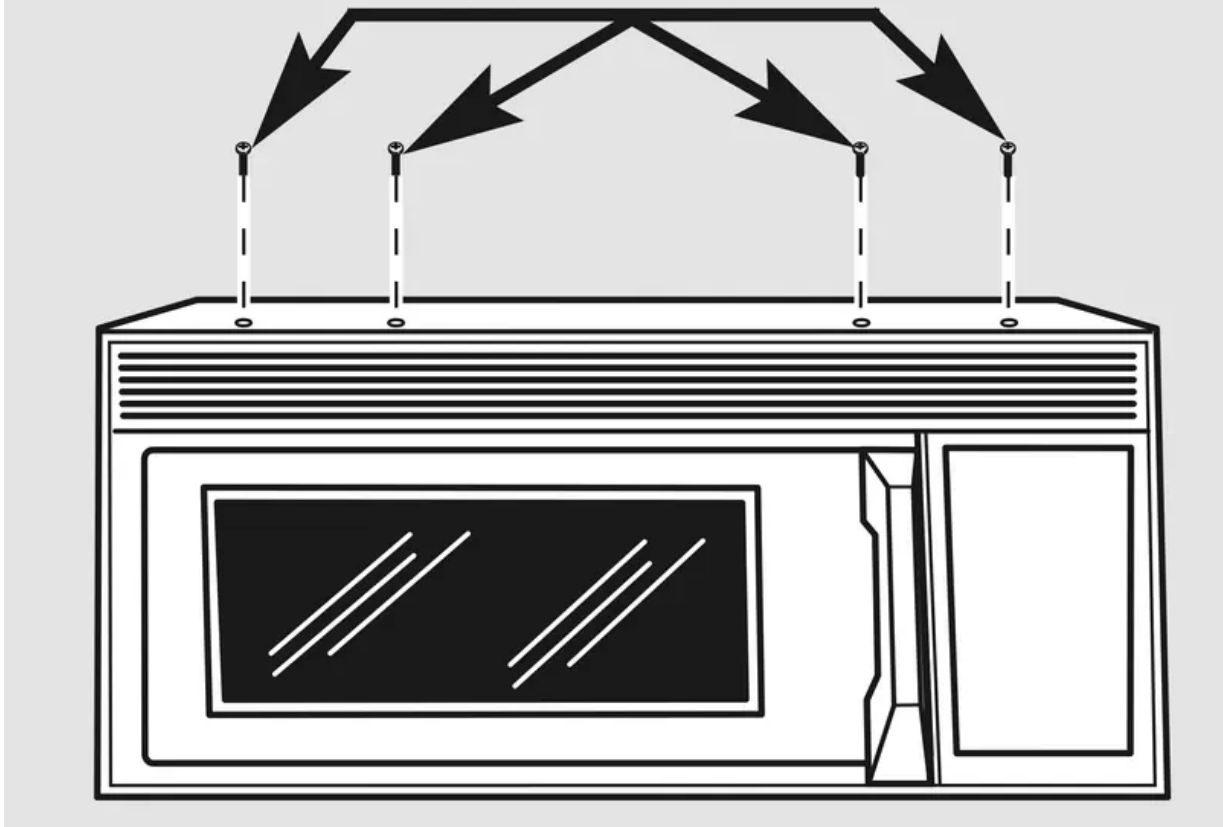

To remove the charcoal filter, disconnect power at the main fuse or circuit breaker panel or pull the plug.

Remove the top grille by removing the 4 screws that hold it in place. Slide the filter toward the front of the oven and remove it.

#### **To Install Charcoal Filter**

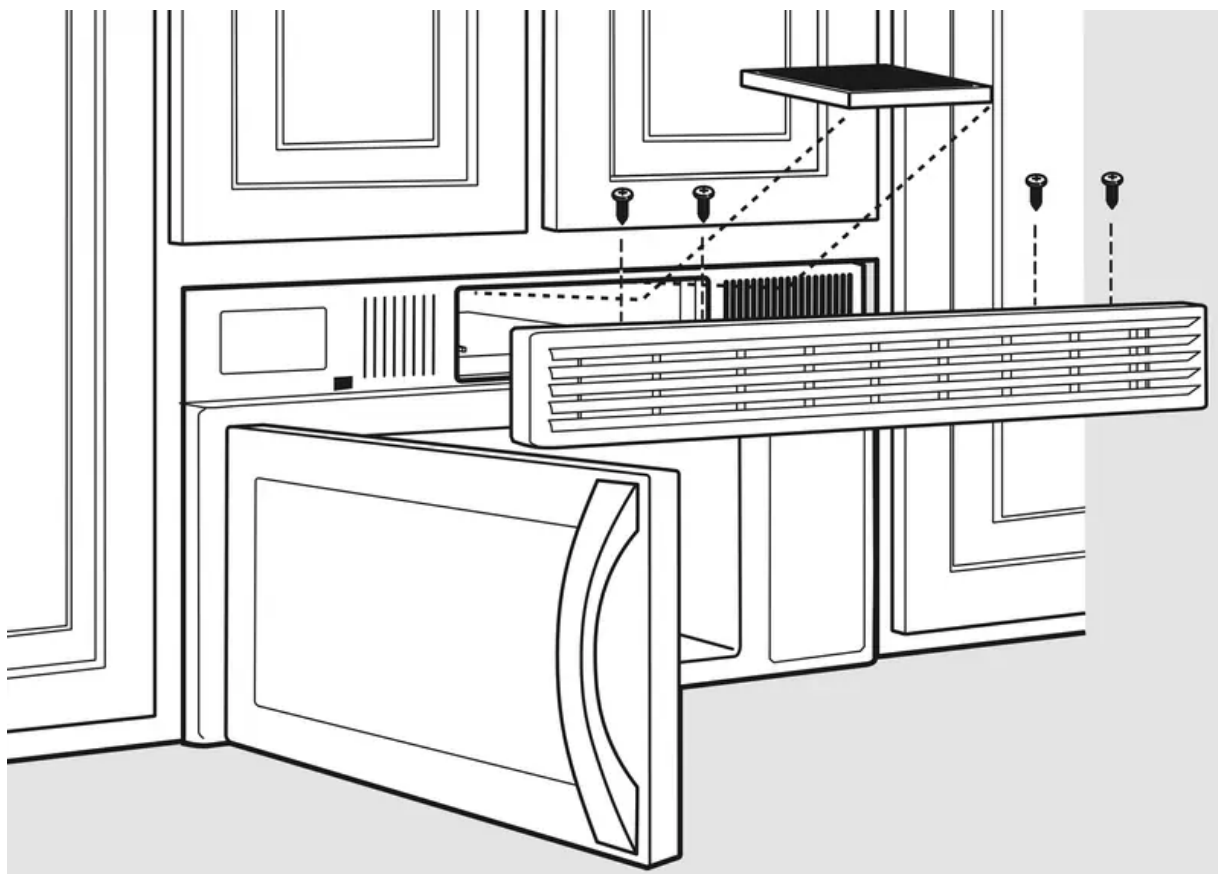

To install a new filter, remove plastic and other outer wrapping from the new filter.

Insert the filter into the top opening of the oven as shown. When properly installed, the wire mesh of the filter should be visible from the front. Replace the grille and 4 screws.

# TROUBLESHOOTING



Problem	Possible Cause	What to Do
<b>Oven will not start</b>	<ul style="list-style-type: none"> <li>• A fuse in your home may be blown or the circuit breaker tripped.</li> <li>• Power surge.</li> <li>• Plug not fully inserted into wall outlet.</li> <li>• Door not securely closed.</li> </ul>	<ul style="list-style-type: none"> <li>• Replace fuse or reset circuit breaker.</li> <li>• Unplug the microwave oven, then plug it back in.</li> <li>• Make sure the 3-prong plug on the oven is fully inserted into wall outlet.</li> <li>• Open the door and close securely.</li> </ul>
<b>Floor of the oven is warm, even when the oven has not been used</b>	<ul style="list-style-type: none"> <li>• The cooktop light is located below the oven floor. When the light is on, the heat it produces may make the oven floor get warm.</li> </ul>	<ul style="list-style-type: none"> <li>• This is normal.</li> </ul>
<b>“LOC” appears on display</b>	<ul style="list-style-type: none"> <li>• The control has been locked.</li> </ul>	<ul style="list-style-type: none"> <li>• Press and hold CLEAR/OFF for about 3 seconds to unlock the control.</li> </ul>
<b>Vent fan will not turn off</b>	<ul style="list-style-type: none"> <li>• The vent fan automatically turns on to cool internal parts while the microwave is on.</li> </ul>	<ul style="list-style-type: none"> <li>• The vent fan cannot be turned off while the microwave is operating. This is normal. Wait for the microwave to turn off and the fan will either go off automatically or you will need to turn it off by pressing the Vent Fan pad after the microwave is off.</li> </ul>



Problem	Possible Cause	What to Do
<b>“BAD PROBE” appears on display</b>	<ul style="list-style-type: none"> <li>• The probe has not been completely inserted into the oven wall outlet.</li> <li>• The probe is defective.</li> </ul>	<ul style="list-style-type: none"> <li>• Insert the probe properly into the oven wall outlet.</li> <li>• Replace the probe.</li> </ul>
<b>“PLEASE INSERT PROBE” appears on display</b>	<ul style="list-style-type: none"> <li>• Probe has been forgotten or not inserted properly.</li> </ul>	<ul style="list-style-type: none"> <li>• Insert the probe properly into the oven wall outlet.</li> </ul>
<b>“SENSOR ERROR” appears on display</b>	<ul style="list-style-type: none"> <li>• When using a Sensor feature, the door was opened before steam could be detected.</li> <li>• Steam was not detected in maximum amount of time.</li> </ul>	<ul style="list-style-type: none"> <li>• Do not open door until steam is sensed and time is shown counting down on display.</li> <li>• Use Time Cook to heat for more time.</li> </ul>

### Things That Are Normal

- Moisture on the oven door and walls while cooking. Wipe the moisture off with a paper towel or soft cloth.
- Moisture between the oven door panels when cooking certain foods. Moisture should dissipate shortly after cooking is finished.
- Steam or vapor escaping from around the door.
- Light reflection around door or outer case.
- Dimming oven light and change in the blower sound at power levels other than high.
- Dull thumping sound while oven is operating.
- The vent fan operating while the microwave is operating. The vent fan will not go off nor can it be turned off until the microwave is off.
- TV-radio interference might be noticed while using the microwave. Similar to the interference caused by other small appliances, it does not indicate a problem with the microwave. Plug the microwave into a different electrical circuit, move the radio or TV as

far away from the microwave as possible or check the position and signal of the TV/radio antenna.

**Warning**

This content is compiled from multiple sources and is provided for reference purposes only. It may not be complete or fully applicable to all situations. If you are unable to resolve your issue, please contact the product manufacturer or an authorized service provider for official support.

---

Document generated by [ManualsFile](#)

