

## Installation

### Step-by-step installation

#### STEP 1 Select a site

Select a site that:

- Has a solid, level surface without carpeting or flooring that may obstruct ventilation
- Is away from direct sunlight
- Has adequate room for opening and closing the door
- Is away from any heat sources
- Provides room for maintenance and servicing
- Has a temperature range between 50 °F (10 °C) and 109 °F (43 °C)

#### Clearance

See the pictures and table below for space requirements for installation.

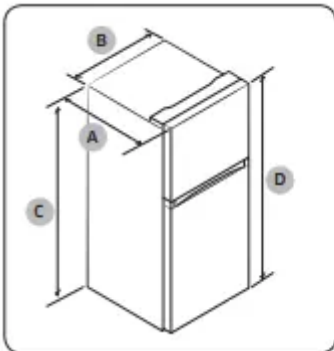

Model	RT18*	RT21*
Depth "A"	31 7/8" (810 mm)	31 7/8" (810 mm)
Width "B"	28 3/4" (729 mm)	32 7/8" (836 mm)
Height "C"	65 3/4" (1669 mm)	66 3/4" (1694 mm)
Overall Height "D"	66 3/4" (1697 mm)	67 3/4" (1722 mm)

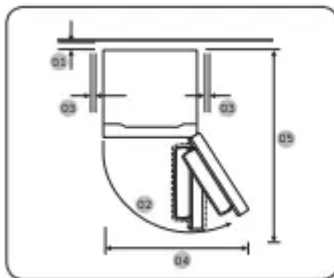

Model	RT18*	RT21*
01	more than 2" (50 mm) recommended	
02	121"	121"
03	at least 2" (50 mm)	at least 2" (50 mm)
04	44" (1117 mm)	50 7/8" (1280 mm)
05	57 7/8" (1470 mm)	59 7/8" (1521 mm)

#### STEP 2 Flooring

- The surface you install the refrigerator on must support a fully loaded refrigerator. (Approximately 200 lb or 90 kg.)
- To protect the floor, put a large piece of cardboard along the path to the refrigerator's final installation location.

- Once the refrigerator is in its final position, do not move it unless necessary to protect the floor. If you have to move the refrigerator, place thick paper or cloth such as old carpets along the path of movement.

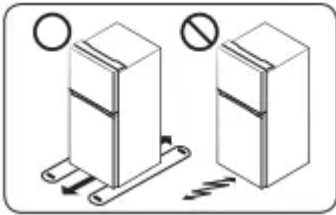

### STEP 3 Adjust the leveling legs

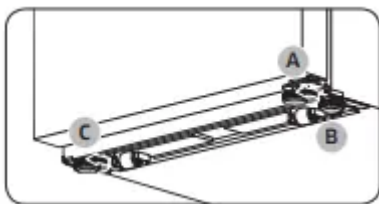

The refrigerator comes with 3 leveling legs, 1 on the door and 2 on the unit. Level the refrigerator by manually adjusting the leveling leg (A) on the door and the leveling leg (C) on the opposite side of the unit. The other leveling leg (B) on the unit is for stability purposes. Turn the leveling legs clockwise to lower the position, or turn counter clockwise to raise.

### CAUTION

- In all cases including door reversal, to prevent the refrigerator from tipping, make sure the leveling leg (A) on the door is on the floor and fully supporting the weight of the door.
- Using only 2 legs on the unit can cause the refrigerator to tip over.

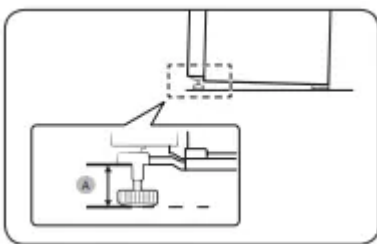

Leave the legs at least (A) mm from the floor as shown.

- (A) 39 mm for RT18\*
- (A) 43 mm for RT21\*

### STEP 4 Connect the water line (optional)

Connect the water line to the ice maker. For the ice maker to operate properly, a water pressure of 20-125 psi is required. After you have connected the water line, make sure the water storage tank inside the refrigerator is properly filled.

To assemble the water line installation kit

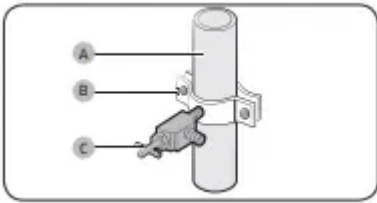

1. Shut off the main water source.
2. Insert the pipe clamp (B) and the shutoff valve (C) into the cold water line (A).

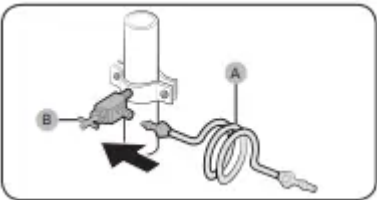

3. Connect the water line installation kit (A) to the shut-off valve (B).

### **STEP 5 Unpack and put accessories in place**

The accessories that ship with this refrigerator are properly packed for transportation and safety reasons. Unpack those accessories and put them in place.

#### **Door guards**

There are four door guards provided with the product. Insert two door guards each to the freezer and the fridge.

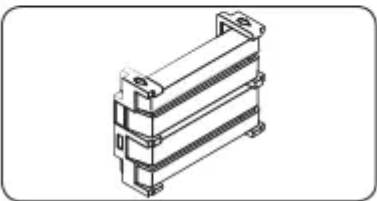
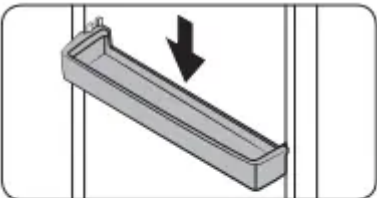

### **STEP 6 Install the Auto Ice Maker (optional)**

To purchase a new auto ice maker (part type : RA-TIMO63PP/AA), visit the Samsung website or contact your retailer.

#### **Ice maker kit**

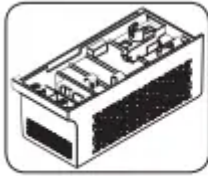

Ice maker

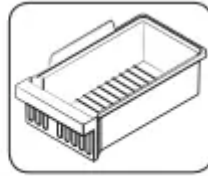

Ice bucket

### Tools required (not provided)

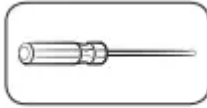

Phillips screwdriver

### To install the ice maker kit

**WARNING** To prevent electrical shock, make sure the refrigerator is turned off before installation.

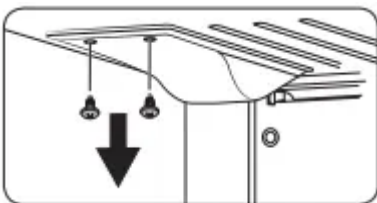

1. See the figure on the left, and then locate the cover on the inner upper corner of the main unit.

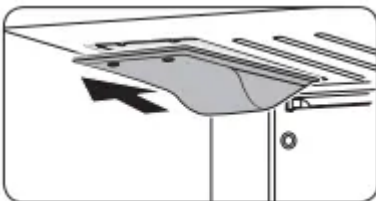

2. Remove the screws (x2) from the cover, and then remove the cover by pulling it to the front.

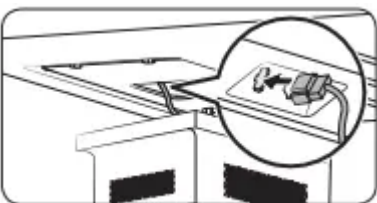

3. Connect the wire connector of the ice maker to the socket (marked in the figure) on the main unit. Make sure the connector is fully inserted to prevent system failure.

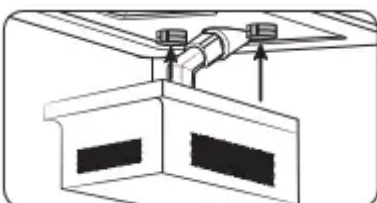

4. Insert the ice maker into the front side of the 2 grommets as shown. Then, push the ice maker inwards to the end. To prevent deviation of the ice maker, make sure the ice maker fits into position.

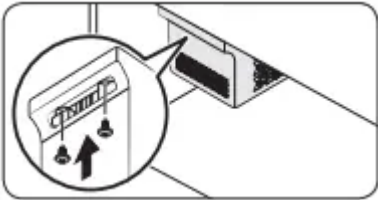
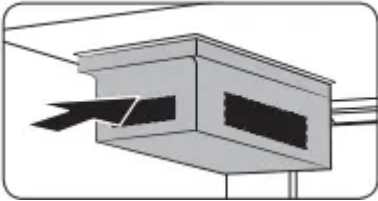

5. Tighten the provided screws (x2) to attach the ice maker firmly to the refrigerator. Make sure the screw holes are aligned with each other before tightening the screws.

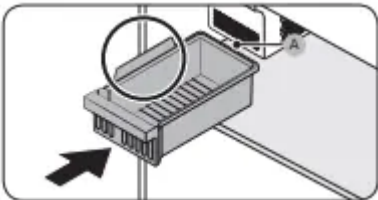

6. Put the ice bucket on the shelf as shown. By design, the ice bucket is supposed to sit behind the ice maker. Otherwise, the ice cubes from the ice maker will not collect in the bucket as intended.

7. When installation is complete, turn the refrigerator on, and then press Test Switch (A) on the ice maker to check if the ice maker operates and supplies water for the ice tray normally.

#### **CAUTION**

- If you don't intend to use the ice maker, or if you are going for a business trip or vacation, turn off the ice maker.
- Do not turn the ice maker on without the ice bucket in place. The ice cubes produced by the ice maker will drop into and scatter through out the freezer.
- Noises may occur when the ice maker is making ice or being supplied with water, or when ice cubes drop into the ice bucket. However, this is not a system failure. When the ice bucket is full, none of these noises will occur.
- The first time you use the ice maker, or after you have replaced the water filter, the ice made by the ice maker may have a carbon residue. If this happens, discard the first full load of ice. Note that the carbon residue is harmless to humans.

#### **STEP 7 Initial settings**

By completing the following steps, the refrigerator should be fully functioning.

1. Plug the power cord into the wall socket to turn the refrigerator on.
2. Open the door, and check if the interior light lights up.
3. Set the temperature to the coldest setting, and wait for about an hour. Then, the freezer should be slightly chilled, and the motor should be running smoothly.
4. Wait until the refrigerator reaches the set temperature. The refrigerator is now ready for use.

## **STEP 8 Final check**

When installation is complete, confirm that:

- The refrigerator is plugged into an electrical outlet and grounded properly.
- The refrigerator is installed on a flat, level surface with a reasonable clearance from the wall or the cabinet.
- The refrigerator is level and is sitting firmly on the floor.
- The door opens and closes freely, and the interior light turns on automatically when you open the door.

## **Operations**

### **01 Power Freeze / Ice Maker (applicable models only)**

Power Freeze

Power Freeze speeds up the freezing process at maximum fan speed.

The freezer keeps running at full speed for several hours and then returns to the previous temperature.

- To activate Power Freeze, press and hold Power Freeze for 3 seconds (Type A), or press and release Power Freeze within 3 seconds (Type B). The corresponding indicator  lights up, and the refrigerator will speed up the freezing process for you.
- For Type B, do not hold down Power Freeze for 3 seconds or more. This will activate the ice maker, not Power Freeze.
- To deactivate, press and hold Power Freeze for 3 seconds (Type A), or press and release Power Freeze within 3 seconds (Type B). The freezer returns to the previous temperature setting.
- To freeze large amounts of food, activate Power Freeze for at least 20 hours before putting food in the freezer.
- The freezer keeps running at full speed for 50 hours and then returns to the previous temperature.

**NOTE** Using Power Freeze increases power consumption. Make sure you turn it off and have the Freezer return to its previous temperature if you no longer need Power Freeze on.

### **Ice Maker (applicable models only)**

By default, the refrigerator is set to make ice with the ice maker indicator on.

To disable this function, press and hold Ice Maker for 3 seconds. We recommend disabling the function in the following cases:

- The ice bucket is already full of ice.
- You want to decrease power consumption.
- When removing the ice maker while it is operating, the ice maker automatically turns off, and the ice maker button (holding down Power Freeze) will be disabled.
- If reattaching the removed ice maker while the refrigerator is on, the ice maker automatically turns on.

## **02 Freezer / Freezer Convert (3 sec)**

### **Freezer**

The Freezer button can be used to set the freezer temperature.

### **CAUTION**

- To prevent system failure or food spoiling, do not set the temperature to Colder in summer (when temperatures are above 95 °F (35 °C)).
- Do not store glass bottles containing liquid in the freezer. Glass bottles will crack or break into pieces when the liquid freezes.

### **Freezer Convert**

You can use the freezer as a freezer only, set the entire refrigerator including the freezer to Fridge mode, or turn off the freezer.

To change the default freezer mode, press and hold Freezer Convert for 3 seconds to enter the selection mode. Then, press Freezer Convert to select a desired mode.

The mode changes in this sequence: Fridge -> Off -> Freezer, then back to Fridge.

- If you select Fridge, the fridge indicator turns on. The freezer will operate in Fridge mode with refrigerator temperatures (above freezing). Power Freeze will be deactivated if active, and Ice On will turn off if enabled.
- If you select Off, the Off indicator turns on. The freezer will be turned off.
- If you switch to Fridge or Off mode, the ice maker automatically turns off after 15 seconds. Empty the ice bucket before you select these modes.
- If you select Freezer, the freezer temperature indicators turn on and the freezer will operate as a freezer (with temperatures below freezing).

- If you switch back to Freezer mode from Fridge or Off mode, the ice maker automatically turns on.

Your changes will be set and activated after 10 seconds. To cancel or change the mode again, press and hold Freezer Convert again for 3 seconds. Then, follow the instructions above.

#### **NOTE**

- If you press and hold Freezer Convert for 3 seconds in other modes, the refrigerator switches to selection mode where you can press Freezer Convert to select a different mode.
- When the fridge or the freezer is set to Off mode, the temperature of the fridge or the freezer remains under 59 °F (15 °C) to prevent mold and odors. The refrigerator will use less electricity.
- The fridge and the freezer cannot be powered off independently.
- Do not store food or beverages in the refrigerator when the refrigeration or freezer functions are set to 'Off mode'. 59 °F (15 °C) is not cool enough to prevent spoilage.

### **03 Fridge / Fridge On/Off (3 sec)**

#### **Fridge**

To adjust the fridge temperature, press Fridge to select the corresponding temperature.

#### **CAUTION**

- In winter, do not set the temperature control to Coldest. This may cause problems with the cooling performance.
- In summer, do not set the temperature control to Colder. This may also cause problems with the cooling performance.

#### **Fridge On/Off**

Press and hold Fridge for 3 seconds to select Fridge On/Off. The temperature indicator will turn off and the Fridge On/Off indicator will turn on.

#### **NOTE**

- In Fridge On/Off mode, the temperature of the fridge or freezer remains under 59 °F (15 °C) to prevent mold and odors. The refrigerator uses less electricity.
- Do not store food or beverages in the refrigerator when the refrigeration or freezer functions are set to 'Off mode'. 59 °F (15 °C) is not cool enough to prevent spoilage.

### **04 Power Cool (3 sec)**

#### **Power Cool**

Power Cool speeds up the cooling process at maximum fan speed. The fridge keeps running at full speed for several hours and then returns to the previous temperature.

- To activate Power Cool, press and hold Power Cool for 3 seconds. The corresponding indicator (🌀) lights up, and the refrigerator will speed up the cooling process for you.
- To deactivate Power Cool, press and hold Power Cool again for 3 seconds. The fridge returns to the previous temperature setting.
- To cool large amounts of food completely, make sure you have activated Power Cool at least 24 hours in advance.

#### **NOTE**

- Using Power Cool increases power consumption. Make sure you turn it off and have the Fridge return to its previous temperature if you no longer need Power Cool on.

#### **Cooling Off mode**

North American (US, Canada) Models Only

Cooling Off mode (also called Shop mode), is designed for use by retailers when they are displaying refrigerators on the shop floor. In Cooling Off mode, the refrigerator's fan motor and lights work normally, but the compressors do not run, and the refrigerator and freezer do not get cold.

- To start Cooling Off mode, press and hold Power Freeze, Freezer and Fridge simultaneously for 5 seconds during normal operation. The refrigerator chime sounds and the temperature LEDs will light up sequentially from left LED to right LED.
- To cancel Cooling Off mode, press and hold Power Freeze, Freezer and Fridge simultaneously again for 5 seconds.

#### **05 Sabbath mode**

The Sabbath mode stays active for 85 hours once it is activated. After that, it will be deactivated automatically.

- To activate, press and hold Power Freeze and Power Cool simultaneously for 5 seconds to enter Sabbath mode. The refrigerator will operate in Sabbath mode where the buttons, display, and the room lamps are controlled by Sabbath mode.
- To deactivate, press and hold the buttons again for 5 seconds to exit Sabbath mode.

**NOTE** Even after the refrigerator powers off and restarts, the Sabbath mode remains active. To exit Sabbath mode, you must deactivate it.

#### **Ice making (applicable models only)**

Twist ice maker

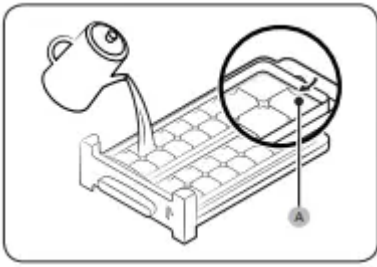

1. Open the freezer door, and slide open the ice tray.
2. Fill the tray with water up to the maximum level (A) marked on the inner rear of the tray.
3. Slide the tray back into position.

**NOTE** The ice making time depends on your temperature settings.



**NOTE**

- Make sure the ice bucket is in place under the ice tray.
- To dispense the ice cubes, turn the handle of the bin to the right to empty half of the ice cubes into the bin. Then, turn it to the left to empty the other half.
- Take out the bin by slightly twisting and pulling to the front.

**Auto ice maker (applicable models only)**

For first-time use

- Let the ice maker make ice for 1-2 days.
- Discard the first 1-2 buckets of ice to remove impurities in the water supply system.
- When the upper ice tray is full, use the lower ice tray



If the auto ice maker does not make ice, remove the ice bucket and press Test Switch (A) to check if the auto ice maker operates properly.



# Maintenance

## Step-by-step instructions

### STEP 1 Remove the doors

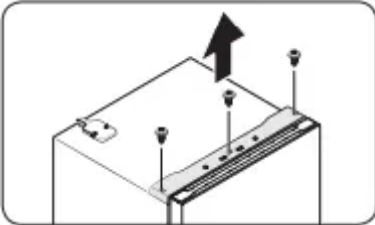

1. Use a Phillips screwdriver to loosen the screws (x3) in three holes on the top table. Then, gently pull out the top table.

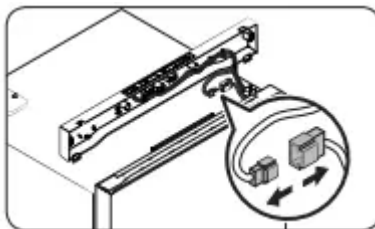

2. Decouple the wire connectors.

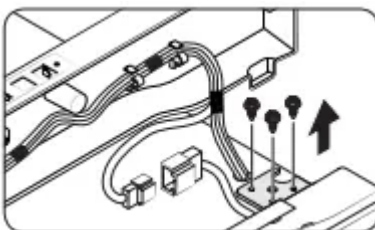

3. Loosen the bolts on the top hinge

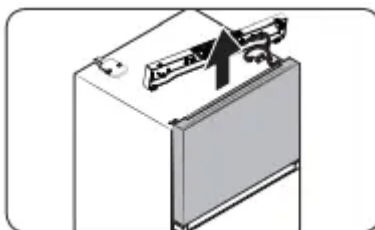

4. Gently lift up the freezer door to remove it.

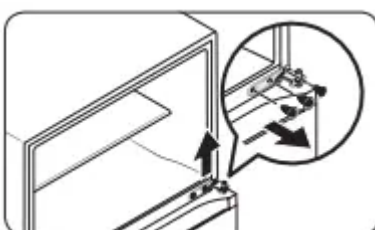

5. Use the screwdriver and the wrench to loosen the bolts and remove the middle hinge.

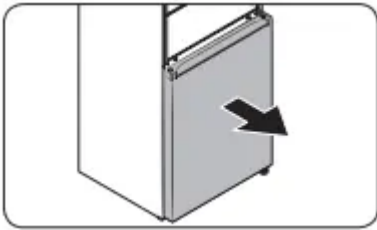

6. Gently slide the fridge door out of the hinge shaft, and then pull up to remove.

### STEP 2 Remove the hinge and the door shaft

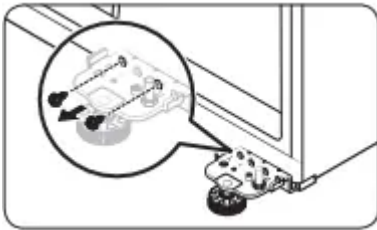

1. Use the screwdriver to remove the screw on the bottom hinge.

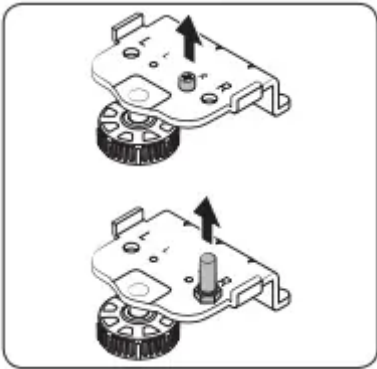

2. Use the screwdriver to remove the hinge bolt. Then, use the wrench to remove the door shaft.

### STEP 3 Reverse the auto closer (freezer door only)

Now stand the refrigerator back upright with care, and then do the following.

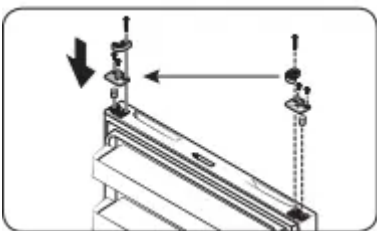

1. Remove the auto closer and the stopper from the bottom of the fridge door. Then, reinsert them on the opposite side of the fridge door as shown.

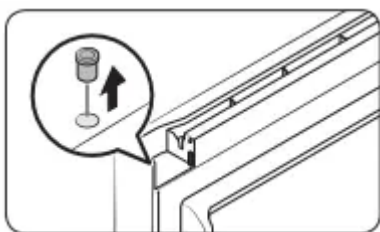

2. Use a flat-head screwdriver to remove the hinge grommet.

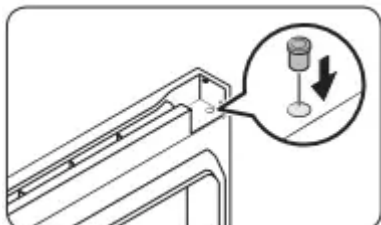

3. Reinsert the hinge grommet on the opposite side.

#### **STEP 4 Reverse the bar cover and the top hinge**

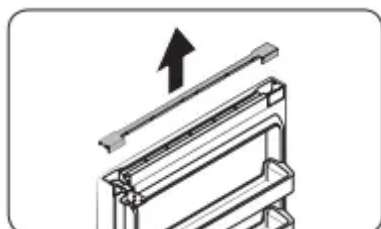

1. Pull up to remove the bar cover on the top of the freezer door.

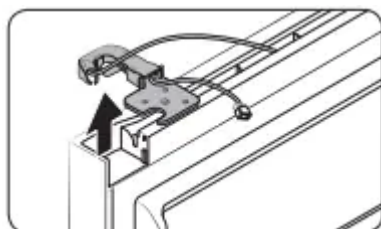

2. Remove the top hinge with its cover.

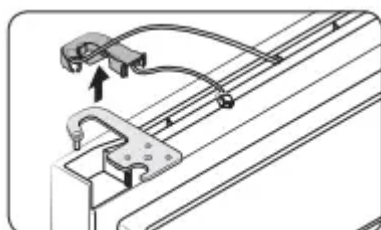

3. Separate the top hinge from the hinge cover.

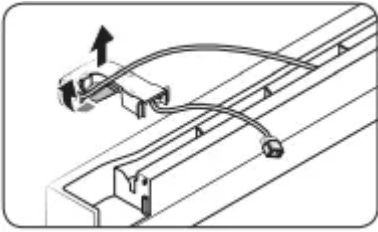

4. Arrange the door wire in the hinge cover.

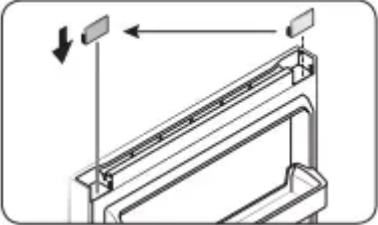

5. Remove the cap spacer, and then reinsert it on the opposite side.

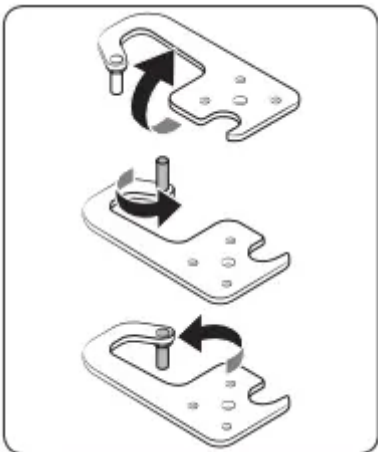

6. Remove the door shaft from the top hinge, flip it 180 degrees as shown, and then reinsert it.

### **STEP 5 Reattach the doors on the opposite side**

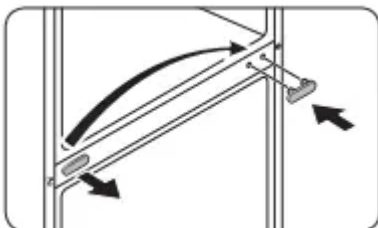

1. Use a flat-head screwdriver to remove the middle-hinge screw cap, and then reinsert it on the opposite side.

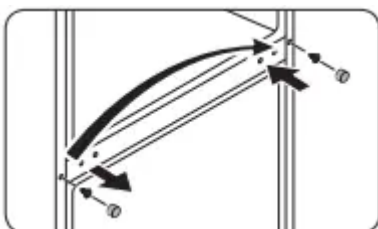

2. Use the flat-head screwdriver to remove the flange-screw cap to reveal the flange screw. Use a Phillips screwdriver to remove the flange screw, and then tighten it on the opposite side. Finally, close the flange-screw cap on the opposite side.

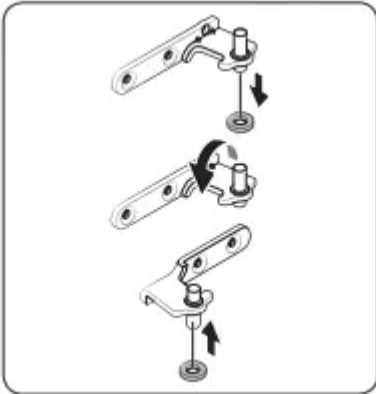

3. Remove the grommet ring from the middle-hinge shaft, and then reinsert the ring on the other side of the shaft. See the figure for visual reference.

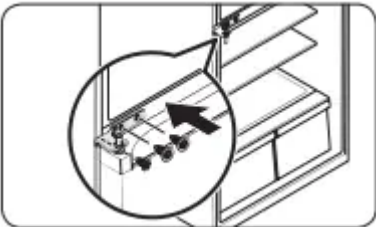

4. Reverse the middle hinge and insert it on the opposite side. Then, tighten the hinge with the screws.

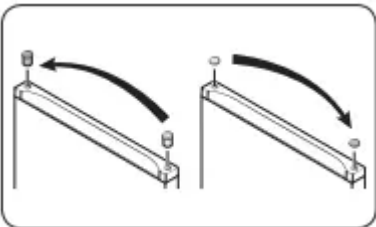

5. Use the flat-head screwdriver to remove both the hinge grommet on one side and the hinge-hole cap on the other side. Reinsert them on their respective opposite side.

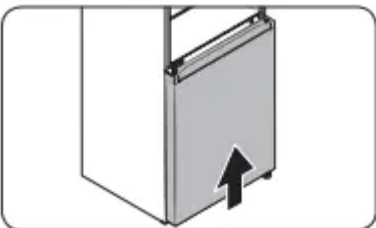

6. Gently slide the fridge door into the correction position so that it fits.

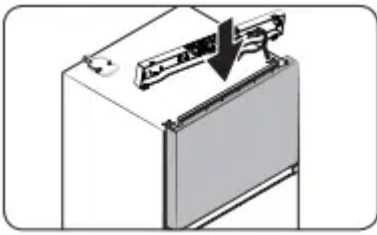

7. Gently slide the freezer door into the correction position so that it fits.

### STEP 6 Reverse the bottom hinge

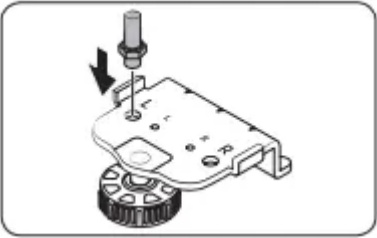

1. Insert the door shaft into the bottom hinge plate from the top as shown, and then tighten it until it is securely in place.

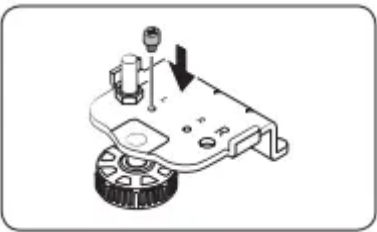

2. Insert the hinge bolt into the bottom hinge plate from the top as shown, and then tighten it until it is securely in place.

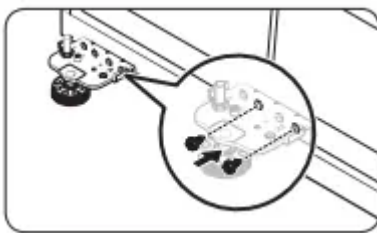

3. Position the bottom hinge plate on the opposite side, and then use two screws to secure and attach the hinge plate as shown.

### STEP 7 Reattach the remaining parts

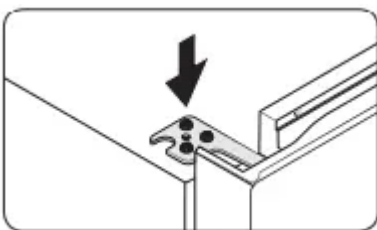

1. Insert and tighten the top hinge on the opposite side.

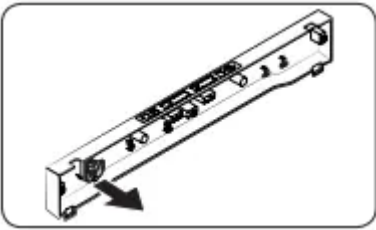

2. Detach the hinge cover manually from the top table.



3. Arrange the door wire in the hinge cover before placing the hinge cover onto the top hinge.

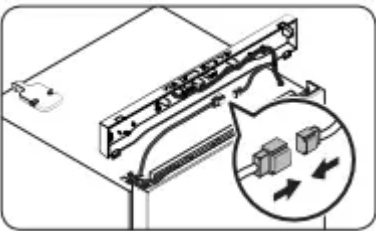
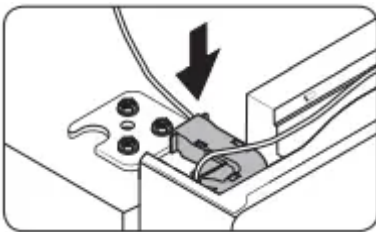

4. Connect the wire connectors.

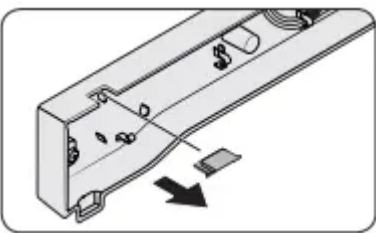

5. Remove the hinge hole cap from the top table, and then reinsert it on the opposite side.

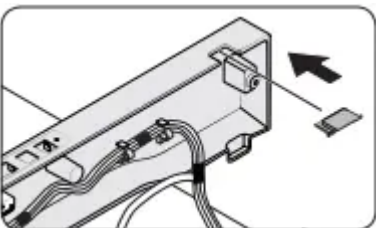

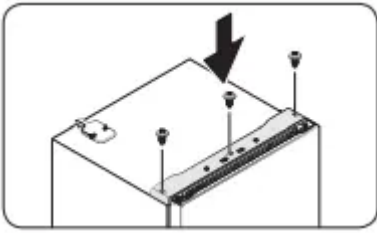

6. Insert the top table, and then fix it firmly to the refrigerator using the screws (x3).

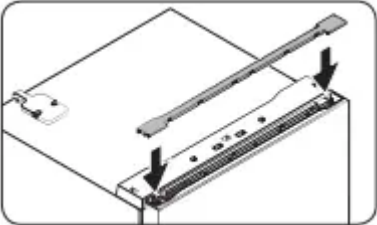

7. Insert the bar cover.



8. Remove the fridge door and freezer door gaskets. Turn them clockwise by 180 degrees, and then reattach them.

**NOTE** In the future, you might want to return the doors to their initial position (before the doors were reversed). In that case, refer to the instructions on the previous pages, but switch the doors, hinges, and covers back to their initial positions.

## Handle and care

### Shelves (fridge/freezer)

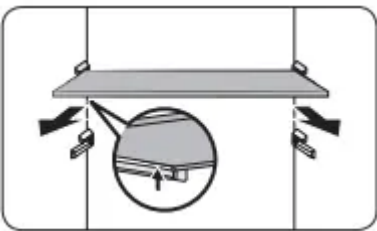

To remove the shelf, hold it with both hands and lift to release from the rear hooks. Then, pull it halfway to the front.

### Fresh room

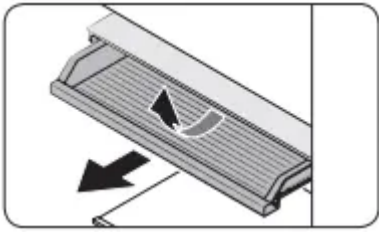

Slide out the sliding shelf of the Fresh room.

### Vegetable drawers

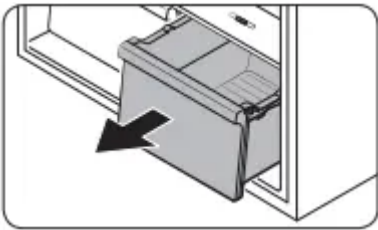

Gently lift up the front of the drawer, and then slide it out.

### Vegetable shelf

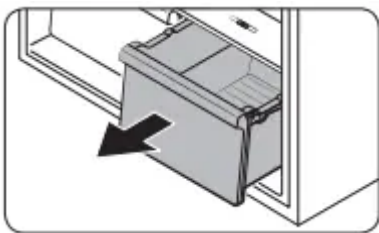

1. Gently lift up the front of the drawer, and then slide it out.

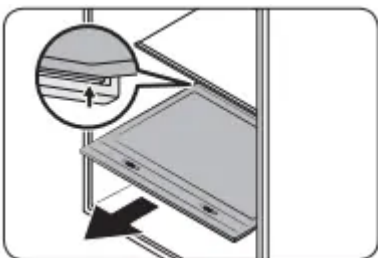

2. Hold the vegetable shelf with both hands, and then slide it out.

### Door shelves

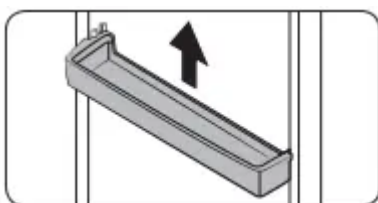

Lift up the door shelf slightly, and then pull it out .

**CAUTION** To prevent accidents, empty the door guards before removing.

### Cleaning

Regularly use a dry cloth to remove all foreign substances such as dust or water from the power plug terminals and contact points.

1. Unplug the power cord of the refrigerator.
2. Use a moistened, soft, lint-free cloth or paper towel to clean the refrigerator's interior and exterior.
3. When done, use a dry cloth or paper towel to dry the refrigerator well.
4. Plug in the power cord of the refrigerator to turn the refrigerator on.

**NOTE** If you have removed any removable parts such as shelves for cleaning, refer to the overall layout in the Refrigerator at a glance section to make sure you have re-inserted them correctly. WA

## Troubleshooting

If you encounter a problem with the refrigerator, first check the tables starting below, and then try the suggested solutions. If none of the suggested solutions resolve your problem, please visit our website or call Samsung Customer Care at 1-800-SAMSUNG (726-7864).

### Temperature

#### **Fridge/freezer does not operate. Fridge/freezer temperature is warm.**

- Power cord is not plugged in properly.  
Properly plug in the power cord.
- Temperature control is not set correctly.  
Set the temperature lower.
- Refrigerator is located near a heat source or in direct sunlight.  
Keep the refrigerator away from direct sunlight or a heat source.
- Not enough clearance between refrigerator and sides/rear.  
We recommend that the gap between the refrigerator and nearby walls (or cabinets) is more than 50 mm.
- The refrigerator is overloaded. Food is blocking the refrigerator vents.  
Do not overload the refrigerator. Do not allow food to block ventilation

#### **Fridge/freezer is over-cooling.**

- Temperature control is not set correctly.  
Set the temperature higher.

#### **Interior wall is hot.**

- Refrigerator has heat-proof piping in the interior wall.

To prevent condensation from forming, the refrigerator has heat-proof piping in the front corners. If the ambient temperature rises, this equipment may not work effectively. This is not a system failure.

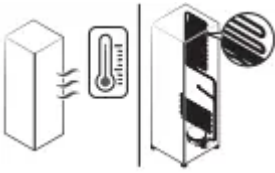

## Odors

Refrigerator has odors.

- Spoiled food.

Clean the refrigerator and remove any spoiled food.

- Food with strong odors.

Make sure strong smelling food is wrapped airtight.

## Frost

**Frost around the vents.**

- Food is blocking the vents.

Make sure no food blocks the refrigerator vents.

**Frost on interior walls.**

- Door is not closed properly.

Make sure food does not block the door. Clean the door gasket.

**Fruits or vegetables are frozen.**

- Fruits or vegetables are stored in the Fresh/Chef Zone.

The Fresh/Chef Zone is only for meat/fish.

## Condensation

**Condensation forms on the interior walls.**

- If door is left open, moisture enters the refrigerator.

Remove the moisture and do not leave the door open for extended periods of time or open the door frequently.

- Food with high moisture content.

Make sure food is wrapped airtight.

## Auto Ice Maker

### The ice maker does not produce ice.

- The freezer room is not cold enough.  
Make sure the cold air outlet is not clogged.
- The ice maker is turned off.  
Make sure the ice maker is turned on. Press and hold Power Freeze for 3 seconds, and check if the corresponding indicator turns on.
- The wire connector of the ice maker is not connected properly.  
Make sure the wire connector from the wire housing is connected properly.
- The water line flowing to the ice maker is bent or kinked.  
Make sure the water line in the rear of the refrigerator is not bent or kinked.

### Do you hear abnormal sounds from the refrigerator?

Before calling for service, review the information below. Note that you will be charged for any service calls related to normal operating sounds in which no defects were found. If you have any questions about sounds your refrigerator is making, please call Samsung Customer Care at 1-800-SAMSUNG (726-7864).

#### These sounds are normal.

- When starting or ending an operation, the refrigerator may make sounds similar to a car engine ignition. As the operation stabilizes, the sounds will decrease.

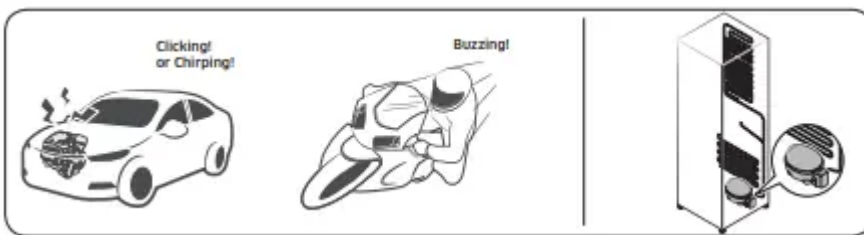

- While the fan is operating, these sounds may occur. When the refrigerator reaches the set temperature, no fan sound will occur.

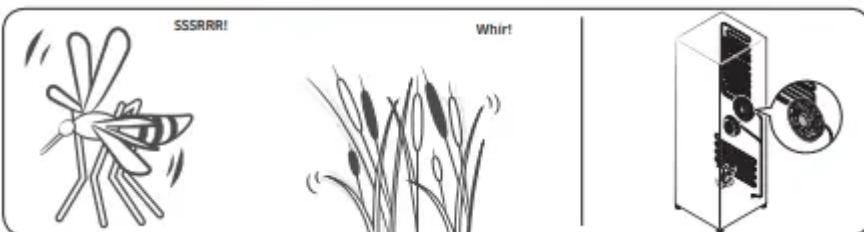

- During a defrost cycle, water may drip on the defrost heater, causing sizzling sounds



- As the refrigerator cools or freezes, refrigerant gas moves through sealed pipes, causing bubbling sounds.

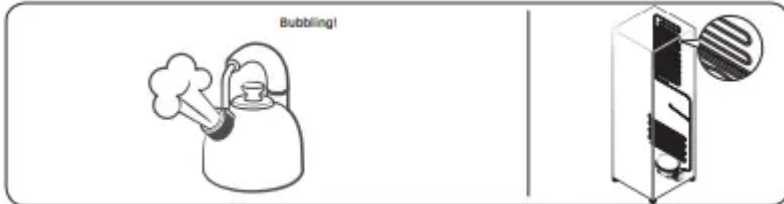

- As the refrigerator temperature increases or decreases, plastic parts contract and expand, creating knocking noises. These noises occur during the defrosting cycle or when electronic parts are working.

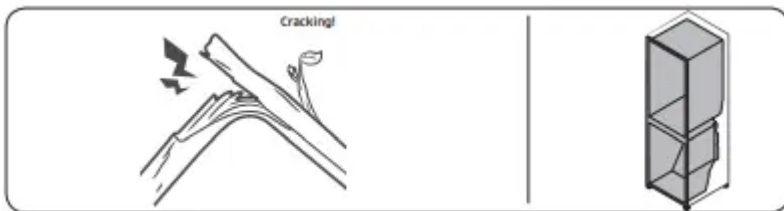

- For ice maker models: When the water valve opens to fill the ice maker, buzzing sounds may occur.
- Due to pressure equalizing when you open and close the refrigerator door, whooshing sounds may occur.

### **Warning**

This content is compiled from multiple sources and is provided for reference purposes only. It may not be complete or fully applicable to all situations. If you are unable to resolve your issue, please contact the product manufacturer or an authorized service provider for official support.