

## FEATURES AND CONTROLS

### SWITCHES



- ① Ignition Switch
- ② Engine Stop Switch
- ③ Mode/Reverse Override Switch
- ④ Headlight Switch
- ⑤ AWD Switch

### IGNITION SWITCH/LIGHT SWITCH

Use the ignition switch to start the engine. The key can be removed from the switch when it is in the OFF position.

OFF	Turn the key to the OFF position to stop the engine. Electrical circuits are off.
RUN	Turn the key the RUN position to activate electrical components. Electrical circuits are on. Electrical equipment can be used.
START	Turn the key to the START position to engage the electric starter. See the Starting the Engine section for starting procedures.

### AWD MODE SWITCH (IF EQUIPPED)

The AWD switch 1 controls the All Wheel Drive (AWD) system. Use this switch to engage AWD or 2X4. The vehicle automatically engages AWD when operating in reverse if the drive mode is set to AWD.

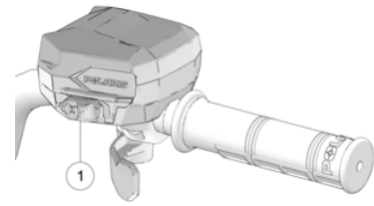

## ENGINE STOP SWITCH

Move the stop switch 2 either left or right to the OFF position to stop the engine quickly. Move the stop switch to the RUN position before attempting to start the engine. The engine will not start or run when the switch is off. Both the main switch and the engine stop switch will shut off all electrical power to the vehicle, including lights.

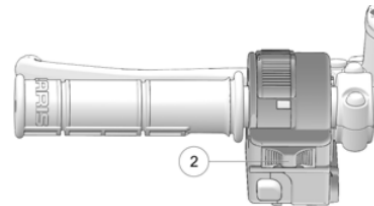

## MODE/REVERSE OVERRIDE SWITCH

This vehicle is equipped with a reverse speed limiter system. To gain additional wheel speed while backing, release the throttle and depress the override button 3. The reverse override button also acts as a MODE button when held down for approximately one half second. The override button will not function as a MODE button if the transmission is in reverse.

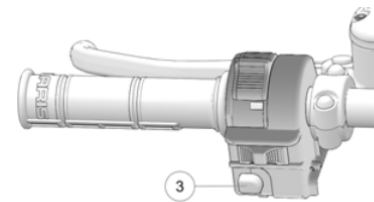

## HEADLIGHT SWITCH

Use the headlight switch to turn the lights on and off and to change the lights from high beam to low beam. The key must be in the ON position and the engine stop switch must be in the RUN position.

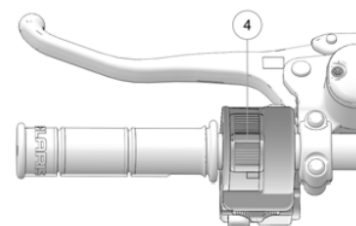

## AUXILIARY OUTLET

The vehicle is equipped with a 12-volt accessory outlet on the dash. Use the outlet to power an auxiliary light or other optional accessories or lights. For service, the dash outlet connection is under the dash.



## OPERATION

### ENGINE AND DRIVETRAIN BREAK-IN

1. Fill the fuel tank with gasoline. See the Fuel Tank section for details. Always exercise extreme caution whenever handling gasoline.
2. Check the oil level. See the Oil Check section for reference. Add the recommended oil as needed to maintain the oil level in the safe operating range.
3. Drive slowly at first. Select an open area that allows room to familiarize yourself with vehicle operation and handling.
4. Avoid aggressive use of the brakes.
5. Vary throttle positions. Do not operate at sustained idle.
6. Pull only light loads.
7. Perform regular checks on fluid levels, controls and areas outlined on the daily pre-ride inspection checklist.
8. During the break-in period, change both the oil and the filter at 25 hours or one month.
9. Check fluid levels of transmission and all gearcases after the first 25 hours of operation and every 100 hours thereafter.

### STARTING THE ENGINE

1. Position the vehicle on a level surface outdoors or in a well-ventilated area.
2. Place the transmission in PARK.
3. Lock the parking brake.
4. Sit on the vehicle and move the engine stop switch to RUN

5. Turn the ignition key past the ON position to engage the starter. Activate the starter for a maximum of five seconds, releasing the key when the engine starts.
6. If the engine does not start, return the key to the OFF position and wait five seconds before attempting to start again. Activate the starter for another five seconds if necessary. Repeat this procedure until the engine starts.

## **NEW OPERATOR DRIVING PROCEDURES**

1. Wear protective riding gear. See the Safe Riding Gear section.
2. Perform the pre-ride inspection.
3. Place the transmission in PARK.
4. Lock the parking brake.
5. Mount the vehicle from the left side.
6. Sit upright with both feet on the footrests and both hands on the handlebars.
7. Start the engine and allow it to warm up
8. Shift the transmission into gear.
9. Check your surroundings and determine your path of travel.
10. Release the parking brake.
11. Slowly depress the throttle with your right thumb and begin driving.
12. Drive slowly. Practice maneuvering and using the throttle and brakes on level surfaces.

## **TURNING THE VEHICLE**

Both rear wheels drive equally at all times. This means that the outside wheel must travel a greater distance than the inside wheel when turning, and the inside tire must slip traction slightly.

1. Slow down.
2. Never turn quickly when carrying cargo.
3. Steer in the direction of the turn.
4. Keep both feet on the footrests.
5. Lean your upper body to the inside of the turn while supporting your weight on the outer footrest. This technique alters the balance of traction between the rear wheels, allowing the turn to be made smoothly. The same leaning technique should be used for turning in reverse.
6. Practice making turns at slow speeds before attempting to turn at faster speeds

# MAINTENANCE

## PERIODIC MAINTENANCE

Any qualified repair shop or person may maintain, replace or repair the emission control devices or systems on your vehicle. An authorized POLARIS dealer can perform any service that may be necessary for your vehicle. POLARIS also recommends POLARIS parts for emissions-related service, however equivalent parts can be used.

It is a potential violation of the Clean Air Act if a part supplied by an aftermarket parts manufacturer reduces the effectiveness of the vehicle's emission controls. Tampering with emission controls is prohibited by federal law.

Owners are responsible for performing the scheduled maintenance identified in this owner's manual. Careful periodic maintenance will help keep your vehicle in safe, reliable condition. Inspect, clean, lubricate, adjust and replace parts as necessary. When inspection reveals the need for replacement parts, genuine POLARIS parts are available from your POLARIS dealer. Equivalent parts may be used for emissions-related service.

Record maintenance and service in the Maintenance Log beginning on page 191. Service and adjustments are important for proper vehicle operation. If you're not familiar with safe service and adjustment procedures, a qualified dealer can perform these operations. Maintenance intervals in the following chart are based upon average riding conditions and an average vehicle speed of approximately 10 miles per hour. Vehicles subjected to severe use must be inspected and serviced more frequently

## SEVERE USE DEFINITION

Severe use is defined as:

- Frequent immersion in mud, water, or sand
- Frequent or prolonged operation in dusty environments
- Short trip cold weather operation
- Racing or racing-style high RPM use
- Prolonged low speed, heavy load operation
- Extended idle

## MAINTENANCE CHART

SYMBOL	DESCRIPTION
XU	Perform these procedures more often for vehicles subjected to severe use.
D	Have an authorized Polaris dealer or other qualified person perform these services.

Perform all services at whichever maintenance interval is reached first. Record maintenance and service in the Maintenance Log.

ITEM	MAINTENANCE INTERVAL (WHICHEVER COMES FIRST)			REMARKS
	HOURS	CALENDAR	MILES (KM)	
Steering	-	Pre-Ride	-	Inspect and make adjustments as needed.
Front Suspension				
Rear Suspension				
Tires				
Brake Fluid Level				
Brake Lever Travel				
Brake System				
Wheels / Fasteners				
CV Boot				
Frame Fasteners				
Engine Oil Level				
Winch (if equipped)				
<b>XU</b> Air Filter (Pre-Filter)				
Coolant	-	Daily	-	Check level daily, change coolant every two years
Head Lights / Tail Lights	-	Daily	-	Check operation; apply dielectric grease if replacing
Power Steering unit (If equipped)	-	Daily	-	Inspect daily, clean often
<b>XU D</b> Brake Pad Wear	10 H	Monthly	100 (160)	Inspect periodically

ITEM	MAINTENANCE INTERVAL (WHICHEVER COMES FIRST)			REMARKS	
	HOURS	CALENDAR	MILES (KM)		
	Battery	20 H	Monthly	200 (320)	Check terminals; clean; test
	Fuel and EVAP System (if equipped)	20 H	Monthly	-	Inspect; cycle key to pressurize fuel pump; check lines and fittings for leaks and abrasion. Replace as needed
<b>XU</b>	Engine Oil Change	25 H	1 M	-	Break-in oil and filter change
	Engine Breather	25 H	1 M	250 (400)	Inspect; replace as needed
<b>XU</b>	Demand Drive Fluid	25 H	1 M	250 (400)	Break-in fluid level check
<b>XU</b>	Rear Gearcase Oil	25 H	1 M	250 (400)	Break-in fluid level check
<b>XU</b>	Transmission Fluid	25 H	1 M	250 (400)	Break-in fluid level check
<b>XU</b>	General Lubrication	50 H	3 M	500 (800)	Lubricate all fittings, pivots, cables, etc.
	Shift Linkage	50 H	3 M	500 (800)	Inspect
<b>D</b>	Steering	50 H	6 M	500 (800)	Lubricate
<b>XU</b>	Front/Rear Suspension	50 H	6 M	500 (800)	Lubricate
<b>XU</b>	Throttle Release Switch (if equipped)	50 H	6 M	500 (800)	Inspect; adjust; lubricate; replace if necessary
	Throttle Body Intake Duct	50 H	6 M	500 (800)	Inspect ducts for proper sealing / air leaks

	Drive Belt	50 H	6 M	500 (800)	Inspect; replace as needed
<b>XU</b>	Air Filter (main element)	50 H	6 M	500 (800)	Inspect; replace as needed
	Cooling System	50 H	6 M	1000 (1600)	Inspect coolant strength seasonally; pressure test system yearly
<b>XU</b>	Radiator	50 H	6 M	1000 (1600)	Inspect; clean external surfaces
<b>XU</b>	Cooling Hoses	50 H	6 M	1000 (1600)	Inspect for leaks
<b>XU</b>	Oil lines and fasteners	100 H	6 M	1000 (1600)	Inspect for leaks and loose fittings
<b>XU</b>	Engine oil change	100 H	6 M	1000 (1600)	Change the oil and filter
<b>XU</b>	Demand drive fluid (normal use)	100 H	12 M	1000 (1600)	Change fluid

ITEM		MAINTENANCE INTERVAL (WHICHEVER COMES FIRST)			REMARKS
		HOURS	CALENDAR	MILES (KM)	
<b>XU</b>	Rear gearcase oil	100 H	12 M	1000 (1600)	Change fluid
<b>XU</b>	Transmission oil	100 H	12 M	1000 (1600)	Change fluid
<b>D</b>	Fuel and EVAP System (if equipped)	100 H	12 M	1000 (1600)	Inspect; cycle key to pressurize fuel pump; check lines and fittings for leaks and abrasion. Replace as needed
<b>XU</b>	Engine Mounts	100 H	12 M	1000 (1600)	Inspect
	Exhaust Pipe / Silencer / Joints	100 H	12 M	1000 (1600)	Inspect; replace worn parts
<b>XU</b>	Spark Plug	100 H	12 M	1000 (1600)	Inspect; replace as needed
<b>XU</b>	Wiring	100 H	12 M	1000 (1600)	Inspect for wear, routing, security; apply dielectric grease to connectors subjected to water, mud, etc.
<b>D</b>	Clutches (Drive/ Driven)	100 H	12 M	1000 (1600)	Inspect; clean; replace worn parts
<b>D</b>	Wheel Bearings	100 H	12 M	1000 (1600)	Inspect; replace as needed
<b>D</b>	Brake Fluid	200 H	24 M	2000 (3200)	Change every two years
	Spark Arrestor	300 H	36 M	3000 (4800)	Clean out; or remove clean out plug. If driving in mud, service/clean spark arrestor daily.
<b>XU</b>	Coolant	-	60 M	-	Replace coolant (50/50 Extended Life Coolant)

<b>XU</b>	Valve Clearance	200 H	-	2000 (3200)	Inspect; adjust as needed
<b>D</b>	Toe Adjustment		-		Inspect periodically; adjust as needed
	Headlight Aim		-		Adjust as needed

## LUBRICATION GUIDE

Check and lubricate all components at the intervals outlined in the Periodic Maintenance Chart. Items not listed in the chart should be lubricated at the General Lubrication interval.

The a-arms and lower control arms are lubricated at the factory, and no additional lubrication will be needed. However, if these components are subjected to severe use, grease zerks have been provided for additional lubrication at the user's discretion.

ITEM	LUBE	CAPACITY AT FLUID CHANGE	INSPECTION PROCEDURE
Engine Oil (450/570)	PS-4 5W-50 4-Cycle Oil	2 qt. (1.9 l)	Maintain level in safe range on dipstick.
Brake Fluid	DOT 4 Brake Fluid	-	Maintain level between fill lines.
Transmission Oil	AGL Gearcase Lubricant & Transmission Fluid	32 oz. (948 ml)	Maintain level at bottom of fill hole threads.
Demand Drive (Front Gearcase)	Demand Drive	9 oz. (265 ml)	Maintain level at bottom of fill hole threads.
Front Prop Shaft	U-Joint Grease	-	Grease fittings (3 pumps maximum) every 500 miles, before long periods of storage, or after pressure washing or submerging.

## ENGINE OIL

Always check and change the oil at the intervals outlined in the Periodic Maintenance Chart. Always use the recommended engine oil. Always change the oil filter whenever changing oil.

Pay special attention to the oil level. A rise in oil level during cold weather can indicate contaminants collecting in the oil sump or crankcase. Change oil immediately if the oil level begins to rise. Monitor the oil level, and if it continues to rise, discontinue use and determine the cause. Your dealer can assist.

## OIL RECOMMENDATIONS

Always change the oil filter whenever changing oil.

POLARIS recommends the use of POLARIS PS-4 Full Synthetic 5W-50 4-cycle oil or a similar oil for this engine. Oil may need to be changed more frequently if POLARIS oil is not used. Always use 5W-50 oil. Follow the manufacturer's recommendations for ambient temperature operation.

See the Lubrication Guide section for fluid recommendations, capacities and plug torques

## OIL LEVEL

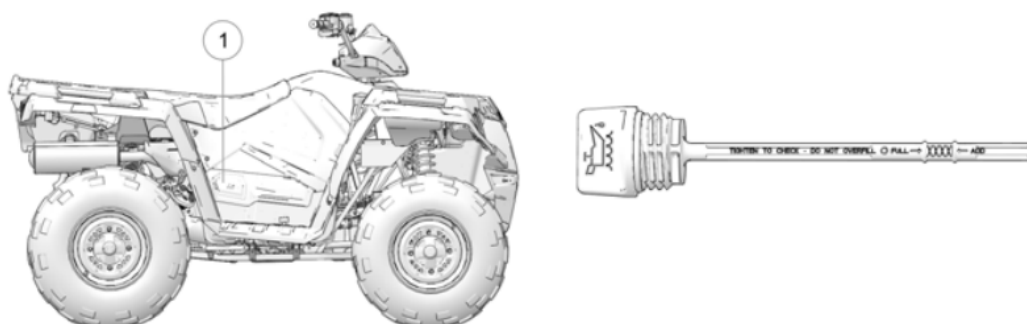

1. Position the vehicle on a level surface.
2. Access the oil dipstick and fill tube from the right side of the ATV 1. Remove the dipstick. Wipe it dry with a clean cloth.
3. Reinstall and tighten the dipstick.
4. Remove the dipstick and check the oil level
5. Add the recommended fluid as needed. Maintain the oil level in the safe range between the FULL and ADD marks. Do not overfill.
6. Reinstall and tighten the dipstick.

## OIL CHANGE

See the fluid recommendation table for capacities and plug torques. Always change the oil at the intervals outlined in the Periodic Maintenance Chart beginning on page 108. Always change the oil filter whenever changing oil.

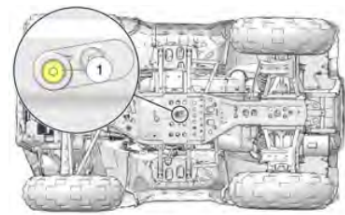

1. Position the vehicle on a level surface.
2. Start the engine. Allow it to warm up at idle for two to three minutes.
3. Stop the engine.
4. Clean the area around the drain plug 1.
5. Place a drain pan under the crankcase.
6. Remove the drain plug 1. Allow the oil to drain completely.
7. Install a new sealing washer on the drain plug. The sealing surfaces on drain plug and crankcase should be clean and free of burrs, nicks or scratches.
8. Reinstall the drain plug. Torque to specification

### TORQUE

11 +/- 1 ft-lbs (16 +/- 1.5 Nm)

## OIL FILTER CHANGE

See the fluid recommendation table for capacities and plug torques. Always change the filter at the intervals outlined in the Periodic Maintenance Chart beginning on .

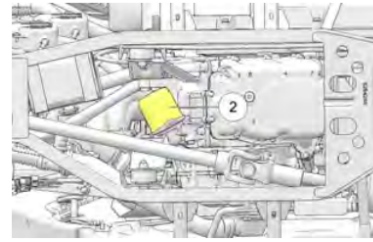

1. Place shop towels beneath the oil filter
2. Using an oil filter wrench (available from your POLARIS dealer), turn the filter counter- clockwise to remove it.
2. Using a clean dry cloth, clean the filter sealing surface on the crankcase.
3. Lubricate the o-ring on the new filter with a film of fresh engine oil. Check to make sure the o-ring is in good condition.
4. Install the new filter and rotate it clockwise by hand until the filter gasket contacts the sealing surface, then turn it an additional 3/4 turn.
5. Remove the dipstick.
6. Add the proper amount of the recommended oil. Do not overfill.
7. Reinstall the dipstick.
8. Place the transmission in PARK
9. Lock the parking brake.
10. Start the engine. Allow it to idle for one to two minutes.
11. Stop the engine.
12. Check for leaks.
13. Check the oil level. Add oil as needed to bring the level to the upper mark on the dipstick.
14. Dispose of used filter and oil properly.

## TRANSMISSION OIL

Always check and change the transmission oil at the intervals outlined in the Periodic Maintenance Chart. See the Fluid Recommendation table for capacities and plug torques. Maintain the oil level at the bottom of the fill plug hole. The fill plug is located on the right side of the ATV behind the footwell. The drain plug is located on the bottom rear side of the gearcase.

## OIL CHECK

1. Remove the fill plug 1. Check the oil level.
2. Add the recommended fluid as needed to bring the level to the bottom of the fill hole threads.
3. Reinstall the fill plug. Torque to specification.
4. Reinstall the footwell.

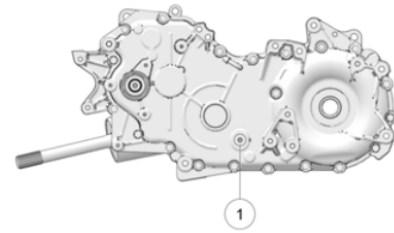

## OIL CHANGE

### TORQUE

**Drain Plug: 20–25 ft lbs. (27–34 Nm)**

1. Place a drain pan under the gearcase. Remove the drain plug 2. Allow the oil to drain completely.
2. Clean and reinstall the drain plug. Torque to specification.
3. Remove the fill plug. Add the proper amount of the recommended oil.
4. Reinstall the fill plug. Torque to specification.
5. Check for leaks.
6. Reinstall the footwell.
7. Dispose of used oil properly

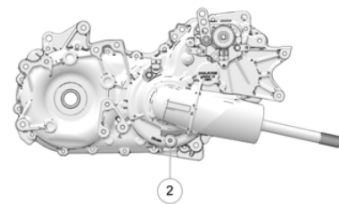

## FRONT GEARCASE (DEMAND DRIVE) FLUID

Always check and change the demand drive fluid at the intervals outlined in the Periodic Maintenance Chart.

Change the front gearcase fluid every 25 hours if the ADC unit is exposed to extreme use. Extreme use includes any of the following:

- operation in ADC mode for prolonged periods
- constant ADC operation on hilly or mountainous terrain
- ADC is the primary mode of all-wheel-drive operation

Use the recommended fluid. Use of other fluids may result in improper operation of components. Maintain the fluid level at the bottom of the fill hole threads. The fill plug is located on the right side of the demand drive unit. The drain plug is located on the bottom right side of the unit.

## FLUID CHECK

TORQUE
<b>Fill Plug: 8–10 ft lbs (11–14 Nm)</b>

1. Position the vehicle on a level surface.  
Remove the fill plug 1. Check the fluid level
2. Add the recommended fluid as needed to bring the level to the bottom of the fill hole threads.
3. Reinstall the fill plug. Torque to specification.

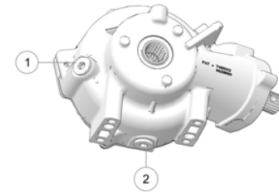

## FLUID CHANGE

1. Position the vehicle on a level surface. Remove the fill plug.
2. Place a drain pan under the demand drive unit. Remove the drain plug 2. Allow the fluid to drain completely.
3. Clean and reinstall the drain plug. Torque to specification.
4. Add the proper amount of the recommended fluid.
5. Reinstall the fill plug. Torque to specification.
6. Check for leaks. Dispose of used fluid properly.

## POWER STEERING UNIT

If your model is equipped with power steering, frequently clean the areas around and on the power steering unit to allow proper cooling. Clean these areas thoroughly.

## STEERING ASSEMBLY

The steering assembly of the ATV should be checked periodically for loose nuts and bolts. If loose nuts and bolts are found, see your authorized dealer or other qualified service facility before operating the vehicle.

## COOLING SYSTEM

The engine coolant level is controlled, or maintained, by the recovery system. The recovery system components are the recovery bottle, the radiator filler neck, the radiator pressure cap and the connecting hose.

As coolant operating temperature increases, the expanding (heated) excess coolant is forced out of the engine, past the pressure cap, and into the recovery bottle. As engine coolant temperature decreases the contracting (cooled) coolant is drawn back up from the bottle, past the pressure cap, and into the radiator.

Some coolant level drop on new vehicles is normal as the system is purging itself of trapped air. Check the coolant level and maintain as recommended by adding coolant to the recovery bottle.

POLARIS recommends the use of POLARIS Antifreeze 50/50 Premix. This antifreeze is already premixed and ready to use. Do not dilute with water. See the Polaris Products section for the part numbers.

### RECOVERY BOTTLE COOLANT

The recovery bottle fluid level can be accessed from the front left wheel well.

1. View the fluid level in the bottle.
2. If the level is low, remove the bottle cap and add coolant as needed. Maintain the coolant level between the minimum and maximum marks on the bottle (when the fluid is cool).
3. Reinstall the cap.
4. Close and secure the front box and cover.

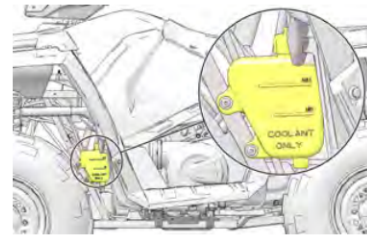

### RADIATOR COOLANT

To ensure that the coolant maintains its ability to protect the engine, we recommend that the system be completely drained every five (5) years and fresh Antifreeze 50/50 Premix added.

Any time the cooling system has been drained for maintenance or repair, replace the coolant with fresh Antifreeze 50/50 Premix. If the recovery bottle has run dry, check the level in the radiator. Add coolant as needed.

1. Access the pressure cap under the front box. See the Front Compartment section for details.

2. Remove the pressure cap.
3. Using a funnel, slowly add coolant through the radiator filler neck.
4. Reinstall the pressure cap. Use of a non-standard pressure cap will not allow the recovery system to function properly. Your POLARIS dealer can provide the correct replacement part.
5. Close and secure the front box and cover.

## **BRAKES**

### **HAND BRAKE**

The front and rear brakes are hydraulic disc brakes, activated by moving the single brake lever toward the handlebar. These brakes are self-adjusting.

Under normal operation, the diaphragm extends into the reservoir as fluid level drops. If the fluid level is low and the diaphragm is not extended, a leak is likely and the diaphragm should be replaced. To ensure proper diaphragm operation, always fill the reservoir as needed whenever the cover is loosened or removed. Do not overfill.

The following checks are recommended to keep the brake system in good operating condition. Check more often if brakes are used heavily under normal operation.

1. Always keep brake fluid at an adequate level. See the Master Cylinder/Brake Fluid section for details.
2. Check the brake system for fluid leaks.
3. Check the brakes for excessive travel or spongy feel.
4. Check the friction pads for wear, damage and looseness. Replace brake pads when they are worn to .030" (0.762 mm).
5. Check the security and surface condition of the disc. Clean any grease using a recommended brake cleaner or alcohol. Do not use spray lubricants or other petroleum-based products. If you discover any damage (cracks, excessive corrosion, warping) see your dealer for service before operating.

### **AUXILIARY FOOT BRAKE**

The hydraulic auxiliary brake system requires no adjustment. Check the brake fluid level frequently for the auxiliary brake system.

## **SEAT REMOVAL (TOURING/1-UP MODELS)**

1. Locate the seat removal latch in the center of the seat's rear.
2. Pull on the latch handle to disengage the seat from the vehicle's frame.
3. Remove the seat.

## **SEAT REMOVAL (X2)**

1. Remove any cargo from the cargo box before removing the seat.
2. Stand beside the vehicle. Pull the cargo box release lever upward. Lift the front of the cargo box.
3. Grasp edge of the seat near the opposite rear corner.
4. Pull upward abruptly to disengage the under-seat fasteners.
5. Remove the seat.

## **SIDE PANEL REMOVAL**

To remove the side panel, do the following:

1. Remove the seat.
2. Use a flat screwdriver to remove the plastic rivets securing the side panel.
3. Grasp the rear of the side panel near the rear cab. With a firm motion, pull the side panel outward to disengage the side panel from the grommets.
4. Pull the panel outward and rearward to remove it.

## **FOOTWELL REMOVAL (1-UP MODELS)**

To remove the footwell, do the following:

1. Remove the four screws on the bottom of the footwell.
2. Use a flat screwdriver to remove the plastic rivets securing the footwell to the fenders.
3. Remove the footwell.

## **FOOTWELL/FOOTWELL SUPPORT REMOVAL (2-UP MODELS)**

To remove the footwell, do the following:

1. Remove the six screws on the bottom of the footwell.
2. Use a flat screwdriver to remove the plastic rivets securing the footwell to the fenders.
3. Remove the footwell.
4. If removing the footwell support is necessary to access the clutch cover, remove the hex flange screw securing the support to the frame.

## **TIRES**

Refer to the specifications section for recommended tire type, size and pressure.

### **TIRE TREAD DEPTH**

Always replace tires when tread depth is worn to 3 mm (1/8") or less.

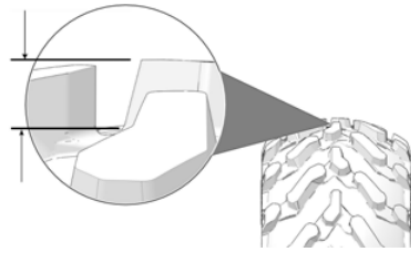

## FRONT WHEEL HUB TIGHTENING

Front wheel bearing tightness and spindle nut retention are critical component operations. All service must be performed by your authorized dealer or other qualified service facility

## WHEEL REMOVAL



1. Stop the engine.
2. Place the transmission in PARK.
3. Lock the parking brake.
4. Loosen the wheel nuts slightly.
5. Elevate the side of the vehicle by placing a suitable stand under the foot rest frame.
6. Remove the wheel nuts.
7. Remove the wheel.

## WHEEL INSTALLATION

1. Place the transmission in PARK.
2. Lock the parking brake
3. Place the wheel on the hub with the valve stem toward the outside and rotation arrows on the tire pointing toward forward rotation (if equipped).
4. Install the wheel nuts and finger-tighten them.
5. Lower the vehicle to the ground.
6. Torque the wheel nuts to specification.

## WHEEL NUT TORQUE SPECIFICATIONS

Check the wheel nut torques occasionally and when they've been loosened for maintenance service.

Lug Nut (Aluminum Wheels) 	Front and Rear	30 ft. lbs. (41 Nm) PLUS 1/4 TURN or 70 degrees
2-Piece Flange Nut (Steel Wheels) 	Front and Rear	27 ft. lbs. (37 Nm)

## TOE ALIGNMENT

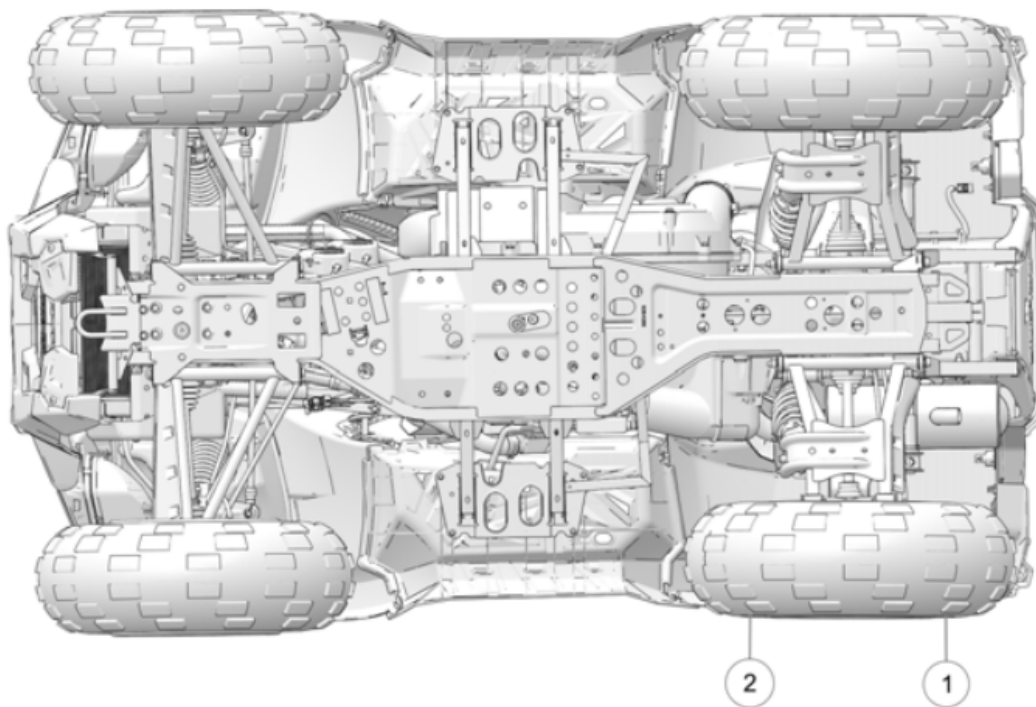

Use the following procedure to check the toe alignment of the vehicle. The recommended toe alignment is 1/4-1/2 inch (6-12 mm).

1. Position the vehicle on a level surface.
2. Place the handlebars in a straight-ahead position
3. Tie a length of string between two stands. Position the stands so that the string is flush with the side of the rear tire. If available, you may use a long straight-edge instead of string.
4. Measure the distance from the string to the rim at the front 1 and rear 2 of the front rim. The rear measurement should be 1/8–1/4 inch (3–6 mm) more than the front measurement on each side of the vehicle to obtain the recommended 1/4–1/2 inch (6–12 mm) toe out alignment.

5. Repeat the measurement procedure on the other side of the vehicle.
6. If you discover improper alignment, see your POLARIS dealer for service.

## AIR FILTER

1. Remove the seat. Remove the air box cover clips. Remove the air box cover 1.
2. Remove the filter.
3. Remove the fabric type pre- filter from the main filter. Wash the prefilter in soapy water, then rinse and let dry.
4. Reinstall the pre-filter over the main filter. Install a new main filter if needed.
5. Reinstall the filter into the air box.
6. Reinstall the air box cover and the seat.

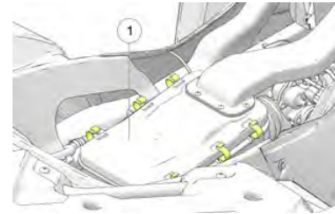

## FUSE REPLACEMENT

If the engine stops or will not start, or if you experience other electrical failures, a fuse may need replacement. Locate and correct any short circuits that may have caused the blown fuse, then replace the fuse. Spare fuses are provided in the fuse box.

1. Open the front box cover, and remove the access panel.
2. Remove fuse box cover.
3. Remove the suspect fuse from the fuse panel. If the fuse is blown, install a new fuse with the same amperage.
4. Secure the fuse box cover and access panel.
5. Secure the front box cover.

## LIGHTS

### HEADLIGHT LAMP REPLACEMENT

When servicing a halogen lamp, don't touch the lamp with bare fingers. Oil from your skin leaves a residue, causing a hot spot that will shorten the life of the lamp. If fingers do touch a lamp, clean it with denatured alcohol.

1. Remove the seven (7) headlight pod screws. Pull the pod cover forward.
2. Unplug the headlamp from the wiring harness. Be sure to pull on the connector, not on the wiring.
3. Turn the lamp counter-clockwise to remove it.

4. Apply dielectric grease to the socket and install the new lamp. Make sure the tab on the lamp locates properly in the housing.
5. Reassemble the pod.

### HIGH BEAM ADJUSTMENT

The headlight beam can be adjusted slightly upward or downward. Use the following procedure to make the adjustment.

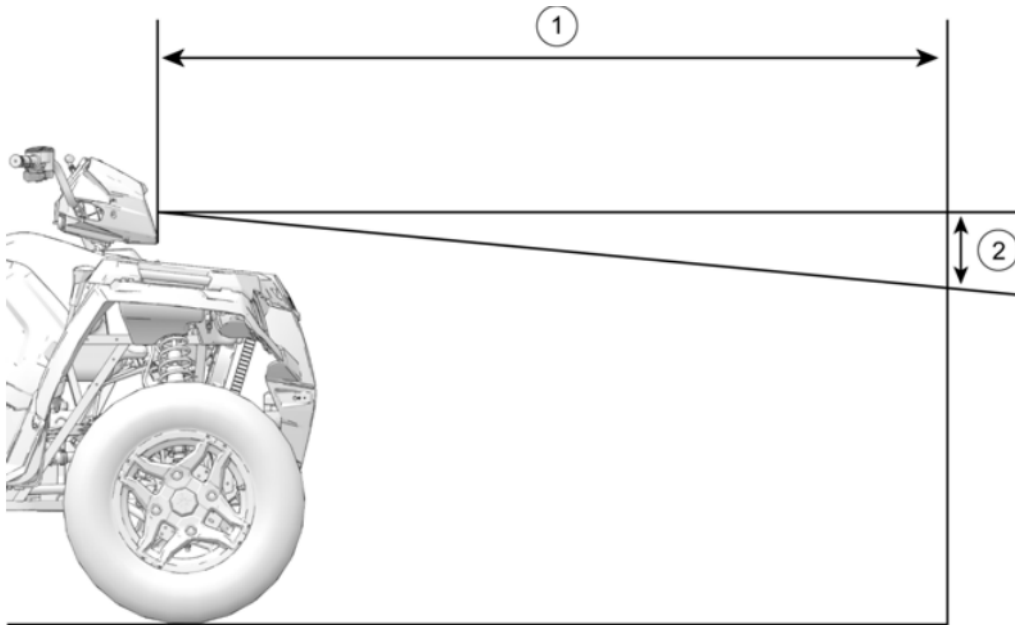

1. Position the vehicle on a level surface with the headlight approximately 25 ft. (7.6 m) from a wall 1. Place the transmission in PARK.
2. Measure the distance from the floor to the center of the headlight and make a mark on the wall at the same height.
3. Start the engine. Turn the headlight switch to high beam.
4. Observe the headlight aim on the wall. The most intense part of the headlight beam should be 2 in. (5 cm) below the mark on the wall 2. Include rider weight on the seat when measuring.
5. The adjustment screw is located on the right side of the headlight pod. To adjust the beam, loosen the screw. Adjust the headlamp to the desired position, then tighten the screw.

### LOW BEAM ADJUSTMENT

The low beam can be adjusted slightly upward or downward.

1. Loosen the Phillips screw located at the rear of the headlamp.
2. Tilt the headlamp upward or downward.
3. Tighten the screw

## HEADLIGHT HOUSING REPLACEMENT

To replace the headlight housing, do the following:

1. Remove the seven (7) headlight pod screws.
2. Pull the pod cover forward.
3. Unplug the headlamp from the wiring harness.
4. Use a small screwdriver to remove the o-rings from the headlight mounting tabs.
5. Pull the headlight housing up from bracket for removal.
6. Reverse the steps to install the new housing and reassemble the pod.

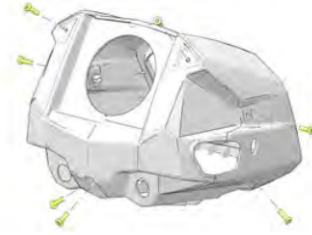

## LOWER HEADLAMP REPLACEMENT

1. Turn the back of the headlight harness counter-clockwise and pull the harness assembly away from the headlight assembly.
2. Remove the headlamp and install the new headlamp.
3. Reinstall the harness assembly into the headlight assembly
4. Turn the headlight harness clockwise to secure the headlamp.

## TAILLIGHTS/BRAKE LIGHTS REPLACEMENT

Procedure to replace taillights:

### **ALL MODELS EXCEPT X2:**

1. Remove the harness connector from the back of the light assembly.
2. Turn the lamp counter-clockwise to remove it.
3. Apply dielectric grease to the socket and install the new lamp.
4. Reinstall the harness connector.
5. Test the light for proper operation.

### **X2:**

1. Open the tailgate.
2. Remove the two screws near the tailgate latch.
3. Grasp the entire taillight assembly and pull it away from the vehicle.
4. Remove the harness connector from the back of the light assembly.

5. Turn the lamp counter-clockwise to remove it.
6. Apply dielectric grease to the socket and install the new lamp.
7. Reinstall the harness connector.
8. Test the light for proper operation.
9. Reinstall the taillight assembly.
10. Reinstall the two screws.

## SPARK PLUGS

### SPARK PLUG RECOMMENDATIONS

Refer to the specifications section for the recommended spark plug type and gap for your vehicle. Torque spark plugs to specification.

ENGINE	TORQUE SPECIFICATION
450	15 ft-lbs (20 Nm)
570	9 ft-lbs (12 Nm)

### SPARK PLUG INSPECTION

Spark plug condition is indicative of engine operation. Check the spark plug firing end condition after the engine has been warmed up and the vehicle has been driven at higher speeds. Immediately check the spark plug for correct color.

1. Rotate the spark plug cap 1/4 turn and pull it off the spark plug.
2. Rotate the spark plug counter-clockwise to remove it.
3. Reverse the procedure for spark plug installation. Torque to specification.

#### ***NORMAL PLUG***

The normal insulator tip is gray, tan or light brown. There will be few combustion deposits. The electrodes are not burned or eroded. This indicates the proper type and heat range for the engine and the service.

The tip should not be white. A white insulator tip indicates overheating, caused by use of an improper spark plug or incorrect throttle body adjustments.

#### ***WET FOULED PLUG***

The wet fouled insulator tip is black. A damp oil film covers the firing end. There may be a carbon layer over the entire nose. Generally, the electrodes are not worn. General causes of fouling are excessive oil, use of non-recommended oil or poor fuel quality

## VEHICLE IMMERSION

If your vehicle becomes immersed, major engine damage can result if the machine is not thoroughly inspected. Take the vehicle in for service before starting the engine. Your POLARIS dealer can provide this service.

If it's impossible to take your ATV to a dealer before starting it, follow the steps outlined below.

1. Move the ATV to dry land or at the very least, to water below the footrests.
2. Check the air box. If water is present, dry the air box and replace the filter with a new filter. If equipped, remove the air box drain plug to drain water. Reinstall the drain plug.
3. Remove the spark plugs.
4. Turn the engine over several times using the electric start.
5. Dry the spark plugs. Reinstall the plugs or install new plugs
6. Attempt to start the engine. If necessary, repeat the drying procedure.
7. Take the vehicle in for service as soon as possible, whether you succeed in starting it or not. Your authorized dealer can provide the required service.
8. If water has been ingested into the PVT, follow the procedure in the PVT System section for drying out the PVT.

## SPARK ARRESTER

The exhaust pipe must be periodically purged of accumulated carbon as follows:

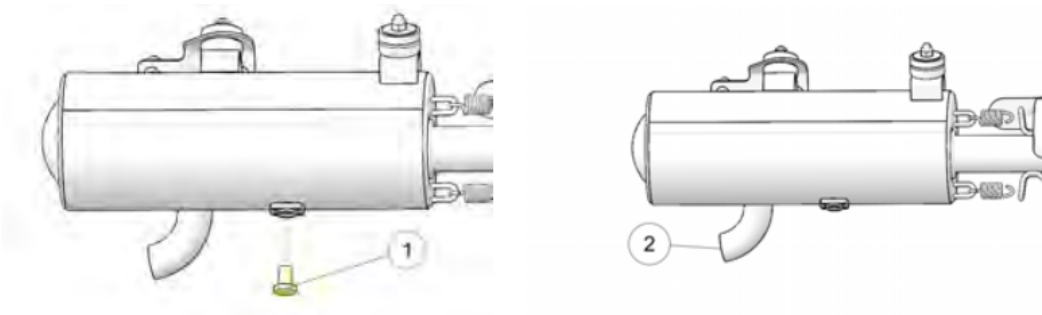

1. Remove the clean out plugs 1 located on the bottom of the muffer.
2. Place the transmission in Park and start the engine. Purge accumulated carbon from the system by momentarily revving the engine several times.
3. If some carbon is expelled, cover the exhaust outlet 2 and lightly tap on the pipe around the clean out plugs with a rubber mallet while revving the engine several more times.
4. If particles are still suspected to be in the muffer, back the machine onto an incline so the rear of the machine is one foot higher than the front. Set the hand brake and block the wheels. Make sure the machine is in Park and repeat Steps 2 and 3. SEE WARNING

5. If particles are still suspected to be in the muffler, drive the machine onto the incline so the front of the machine is one foot higher than the rear. Set the hand brake and block the wheels. Make sure the machine is in Park and repeat Steps 2 and 3. SEE WARNING
6. Repeat steps 2 through 5 until no more particles are expelled when the engine is revved.
7. Stop the engine and allow the arrestor to cool.
8. Reinstall the clean out plugs.

## EVAP MODELS

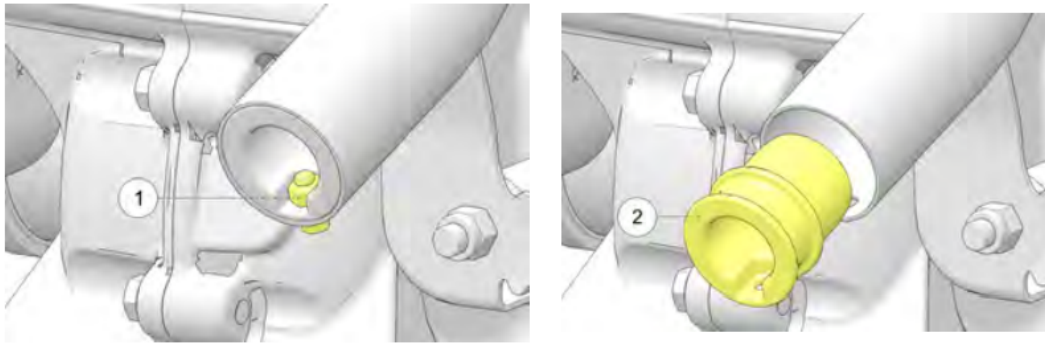

Periodically clean the spark arrester to remove accumulated carbon.

1. Place the transmission in PARK.
2. Remove the arrester retaining bolt and nut 1.
3. Remove the arrester from the end of the muffler 2.
4. Use non-synthetic brush to clean the arrester screen. A synthetic brush may melt if the components are warm. If necessary, blow debris from the screen with compressed air.
5. Inspect the screen for wear and damage. Replace a worn or damaged screen.
6. Reinstall the arrester.
7. Torque the bolt to specification.

<b>TORQUE</b>
7–9 ft. lbs. (10–12 Nm)

## PVT SYSTEM

The basic operation of the POLARIS PVT system is dependent on engine speed and vehicle torque requirements. As engine speed increases, the force exerted on the movable drive sheave by the flyweights also increases. This, in turn, increases the amount of pinch applied to the drive belt. Similarly, if the engine speed decreases, the amount of centrifugal force decreases, reducing the amount of belt pinch.

On POLARIS ATVs, the approximate gear ratio difference between high and low range is 1:2.25. This difference in gearing affects the operation of the PVT, especially at speeds less than 7 MPH (11 km/h), due to the system's dependence on engine speed.

For example, when operating at a ground speed of 3 MPH (5 km/h) in low range, the engine speed would be around 3000 RPM. This is well above the engagement speed of 1600 - 1800 RPM. However, in high range at 3 MPH (5 km/h), the engine would be running at only 1500 RPM. Whenever operating this close to the engagement speed, the engine may be running at a speed too low to provide the pinch needed to prevent belt slip. Belt slip is responsible for creating the excessive heat that destroys belts, wears clutch components and causes outer clutch covers to fail.

The air temperature in the clutch cover is substantially reduced by using low range while operating at low ground speeds. Reducing the temperature inside the clutch cover greatly extends the life of the PVT components (belt, cover, etc.).

### WHEN TO USE LOW RANGE AND HIGH RANGE

CONDITION	RANGE TO USE
Operating at speeds less than 7 MPH (11 km/h)	Low
Towing heavy loads	Low
Operating in rough terrain (swamps, mountains, etc.)	Low
Operating at speeds greater than 7 MPH (11 km/h)	High

### PVT DRYING

There may be some instances when water is accidentally ingested into the PVT system. Use the following instructions to dry it out before operating.

1. Position the vehicle on a level surface.
2. Remove the drain plug. Allow the water to drain completely. Reinstall the drain plug.
3. Start the engine. Place the transmission in PARK
4. Apply varying throttle for 10-15 seconds to expel the moisture and air-dry the belt and clutches. Do not hold the throttle wide open for more than 5 seconds.
5. Allow the engine RPM to settle to idle speed, then shift the transmission to low range.
6. Test for belt slippage. If the belt slips, repeat the process. Your vehicle requires service as soon as possible, which your authorized dealer can provide.



## BATTERY

Your ATV is equipped with a sealed battery, which requires little maintenance. POLARIS does not recommend using a conventional battery in this vehicle. The orientation of the battery could result in electrolyte leakage, which would shorten the life of the battery considerably.

Always keep battery terminals and connections free of corrosion. If cleaning is necessary, remove corrosion with a stiff wire brush. Wash with a solution of one tablespoon baking soda and one cup water. Rinse well with tap water and dry off with clean shop towels. Coat the terminals with dielectric grease or petroleum jelly

### BATTERY REMOVAL

1. Disconnect the battery hold-down strap.
2. Remove the battery cover (if equipped).
3. On conventional batteries, remove the battery vent tube.
4. Disconnect the black (negative) battery cable first
5. Disconnect the red (positive) battery cable last.
6. Lift the battery out of the ATV. Be careful not to tip a conventional battery sideways, which could spill electrolyte.

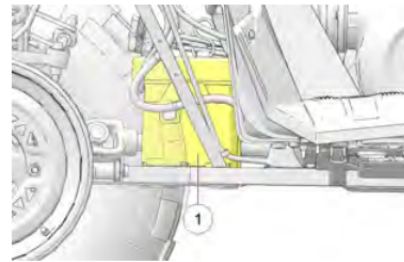

### BATTERY INSTALLATION

1. Clean battery cables and terminals with a stiff wire brush. Corrosion can be removed using a solution of one cup water and one tablespoon baking soda. Rinse well with clean water and dry thoroughly.
2. Place the Battery in the tray.
3. Coat terminals and bolt threads with dielectric grease or petroleum jelly.
4. Connect and tighten the red (positive) cable 5. Torque to specification.

## TORQUE

Battery Terminals:  
**5 ft-lbs (7 Nm)**

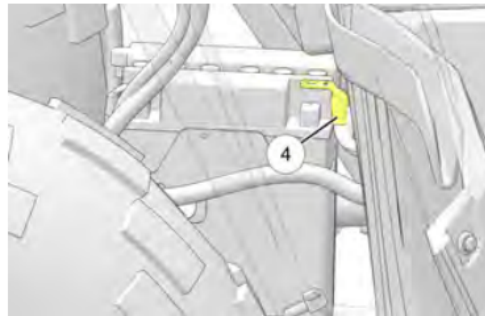

5. Connect and tighten the black (negative) cable 4. Torque to specification.

## TORQUE

Battery Terminals:  
**5 ft-lbs (7 Nm)**

6. Install clear battery vent tube from vehicle to battery vent. (Applies to Conventional Batteries Only).

7. Install the battery cover 3.

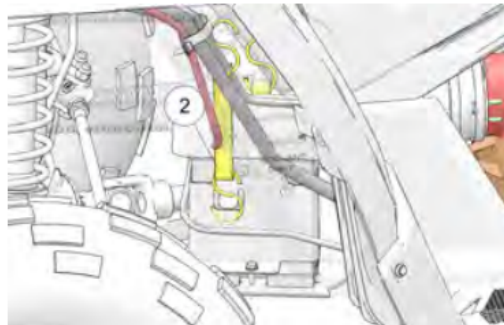
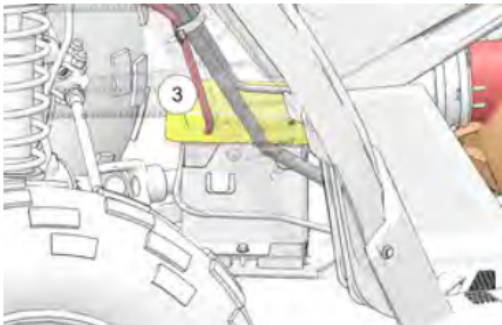

8. Install the battery strap 2.

9. Verify that cables are properly routed.

## BATTERY STORAGE

Whenever the vehicle is not used for a period of three months or more, remove the battery from the vehicle, ensure that it's fully charged, and store it out of the sun in a cool, dry place. Check battery voltage each month during storage and recharge as needed to maintain a full charge.

POLARIS recommends maintaining battery charge by using a POLARIS Battery Tender charger or by charging once a month using the battery tender port 1. Battery Tender can be left connected during the storage period, and will automatically charge the battery if the voltage drops below a predetermined point. See the Polaris Products section for the part numbers.

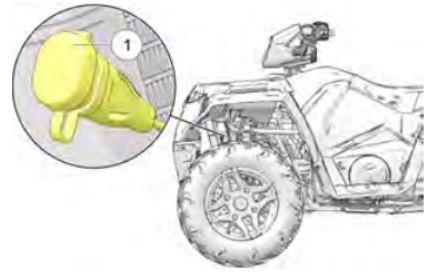

## BATTERY CHARGING

The following battery charging instructions apply only to the installation of a sealed battery. Read all instructions before proceeding with the installation of this battery.

The sealed battery is already filled with electrolyte and has been sealed and fully charged at the factory. Never pry the sealing strip off or add any other fluid to this battery.

The single most important thing about maintaining a sealed battery is to keep it fully charged. Since the battery is sealed and the sealing strip cannot be removed, you must use a voltmeter or multimeter to measure DC voltage.

For a refresh charge, follow all instructions carefully.

1. The battery should be disconnected from a load or charger for at least two hours before checking voltage. Check the battery voltage with a voltmeter or multimeter. A fully charged battery will register 12.6 V or higher.
2. If the voltage is less than 12.6 volts, recharge the battery at 1.2 amps or less until battery voltage is 12.6 or greater.
3. When using an automatic charger, refer to the charger manufacturer's instructions for recharging. When using a constant current charger, use the following guidelines via the table below.

### **BATTERY CHARGING (SEALED BATTERY)**

Always verify battery condition before and 1-2 hours after the end of charging

STATE OF CHARGE	VOLTAGE	ACTION	CHARGE TIME (USING CONSTANT CURRENT CHARGER @ STANDARD AMPS SPECIFIED ON TOP OF BATTERY)
100%	12.6-12.8 volts	Conventional/Low Maintenance Battery: check after 60 days AGM Battery: check after 30 days	None required
50%-75%	12.0-12.5 volts	Needs charge	5-11 hours
25%-50%	11.5-12.0 volts	Needs charge	At least 13 hours, verify state of charge
0%-25%	11.5 volts or less	AGM ONLY: needs charge with desulfating charger	At least 20 hours

## BATTERY IDENTIFICATION

### CONVENTIONAL BATTERY

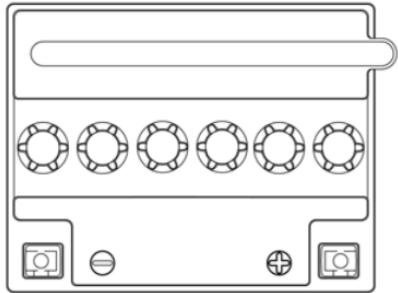
<ul style="list-style-type: none"> <li>• The battery is NOT activated when packaged</li> <li>• Distilled water and electrolyte added as required</li> <li>• Removable cap plugs located on top of battery</li> <li>• Vent tube located on side of battery</li> </ul>	
--	--

### LOW MAINTENANCE BATTERY

<ul style="list-style-type: none"> <li>• Battery activated when packaged</li> <li>• Distilled water and electrolyte NEVER added</li> <li>• Non removable cap(s) located on top of battery</li> </ul>	
--	---

## LEAD ACID CONVENTIONAL / DRY SHIPPED AGM BATTERY BEST PRACTICES

Some Polaris ORV models include either a Lead Acid Conventional battery or a Dry Shipped Absorbed Glass Mat (AGM) battery. See the Service Manual for procedures on how to activate, charge, maintain, and test a Lead Acid Conventional or Dry Shipped AGM battery

### LEAD ACID CONVENTIONAL BATTERIES

## ACTIVATION

- Do NOT activate the battery unless it will be put into regular service within 30 days. Bulk acid should be used to activate the battery.
- Always remove the sealing cap from the vent elbow before activating the battery. Never put the sealing cap back onto the battery. The gas pressure can cause the battery to rupture.
- Let the battery sit for 30 minutes after you add the initial electrolyte. Once absorbed, fill the battery with additional electrolyte to the upper line of the electrolyte level indicator. This is the only time that electrolyte should be added to the battery.
- Once the battery is fully charged, replace cap plugs by hand. Do NOT use a tool to install the cap plugs.

## CHARGING

- The battery must be fully charged before use or battery life will be significantly reduced by 10-30% of the battery's full potential.
- Nominal voltage is 12.6 to 12.8 Volts when fully charged. If the voltage falls below 12.5V, charge it immediately, or the battery service life and vehicle performance may be affected.
- Polaris recommends using a BatteryMINDer® 12V 1.5 AMP Convertible (PN 2830511) charger (or a similar charger), which can be ordered through your normal parts channel.
- Charge the battery with a charging output no larger than 10% of the battery's amp-hour rating.

## MAINTENANCE

- Recharge the battery to its full capacity every 30 to 60 days.
- If the battery is stored or used in a partially charged condition, battery service life and vehicle performance may be adversely affected.
- Never add any electrolyte to the battery once the battery is in service. After the battery is initially activated, only distilled water should be added to maintain electrolyte levels.
- Store the battery in the vehicle with the cables disconnected, or store the battery in a cool / dry location. Batteries will self discharge more rapidly when stored in extreme temperatures.

## TESTING

- If the test fails, fully charge the battery.
- Proper load testing of the battery requires special equipment and can be performed by your dealer.

## ***DRY SHIPPED AGM BATTERIES***

### ACTIVATION

- Do NOT activate the battery unless it will be put into regular service within 30 days. Only use the electrolyte container supplied with the battery to activate the battery.
- Keep the electrolyte container in place for 20 minutes or longer until the container is completely empty. If necessary, gently tap the container to empty it.
- Once the battery is fully charged, replace the strip of caps by hand. Do NOT use a tool to install the strip.

## CHARGING

- Polaris recommends using a BatteryMINDER® 2012 AGM - 2 AMP (PN 2830438) charger, which can be ordered through your normal parts channel.
- Nominal voltage is 12.8 Volts when fully charged. If the voltage falls below 12.5V, charge it immediately, or the battery runs the risk of sulfation.

## MAINTENANCE

- Never add any electrolyte or distilled water to the battery once the battery is in service.
- If you do not drive the vehicle for more than TWO weeks, maintain the battery with the BatteryMINDER® 2012 AGM - 2 AMP (PN 2830438) charger.
- If you plan to store the vehicle for ONE month or longer, remove the battery from the vehicle and store the battery in a cool / dry location. Continue to maintain the battery with the BatteryMINDER® 2012 AGM - 2 AMP (PN 2830438) charger and inspect the battery every 60 days.

## TESTING

- If the test fails, fully charge the battery.
- If the battery is too low to accept a charge, see the AGM Battery Charging - Deeply Discharged (Below 3 Volts) procedure in the Service Manual.
- Proper load testing of the battery requires special equipment and can be performed by your dealer.

## **LOW MAINTENANCE BATTERY BEST PRACTICES**

Some Polaris ORV models include either a Lead Acid or Absorbed Glass Mat (AGM) Low Maintenance battery. See the Service Manual for procedures on how to charge, maintain, and test a Lead Acid or AGM Low Maintenance battery

### **LEAD ACID LOW MAINTENANCE BATTERY**

## CHARGING

- The battery must be fully charged before use or battery life will be significantly reduced by 10-30% of the battery's full potential.

- Nominal voltage is 12.6 to 12.8 Volts when fully charged. If the voltage falls below 12.5V, charge it immediately, or the battery service life and vehicle performance may be affected.
- Polaris recommends using a BatteryMINDER® 12V 1.5 AMP Convertible (PN 2830511) charger (or a similar charger), which can be ordered through your normal parts channel.
- Charge the battery with a charging output no larger than 10% of the battery's amp-hour rating.

#### MAINTENANCE

- Recharge the battery to its full capacity every 30 to 60 days.
- If the battery is stored or used in a partially charged condition, hard crystal sulfation will form on the plates, reducing the efficiency and service life of the battery.
- Never add electrolyte or distilled water to the battery. Doing so will damage the case and shorten the life of the battery.
- Store the battery in the vehicle with the cables disconnected, or store the battery in a cool / dry location. Batteries will self discharge more rapidly when stored in extreme temperatures.

#### TESTING

- Test the battery using the PU-50296 battery tester.
- Proper load testing of the battery requires special equipment and can be performed by your dealer.

#### **AGM LOW MAINTENANCE BATTERIES**

#### CHARGING

- Polaris recommends using a BatteryMINDER® 2012 AGM - 2 AMP (PN 2830438) charger, which can be ordered through your normal parts channel.
- Nominal voltage is 12.6–12.8 Volts when fully charged. If the voltage falls below 12.5V, charge it immediately, or the battery runs the risk of sulfation.

#### MAINTENANCE

- Never add electrolyte or distilled water to the battery. Doing so will damage the case and shorten the life of the battery.
- If you do not drive the vehicle for more than TWO weeks, maintain the battery with the BatteryMINDER® 2012 AGM - 2 AMP (PN 2830438) charger.
- If you plan to store the vehicle for ONE month or longer, remove the battery from the vehicle and store the battery in a cool / dry location. Continue to maintain the battery with the BatteryMINDER® 2012 AGM - 2 AMP (PN 2830438) charger and inspect the battery every 60 days.

#### TESTING

- If the test fails, fully charge the battery.
- If the battery is too low to accept a charge, see the AGM Battery Charging - Deeply Discharged (Below 3 Volts) procedure in the Service Manual.
- Proper load testing of the battery requires special equipment and can be performed by your dealer.

## **CAMBER AND CASTER**

The camber and caster are non-adjustable.

## **REAR SPRING**

The rear shock absorber spring is adjusted by rotating the adjuster either clockwise or counter-clockwise to increase or decrease spring tension.

Accessory springs are available through your POLARIS dealer.

## **HANDLEBARS**

The handlebars can be adjusted for rider preference.

1. Remove the upper headlight pod.
2. Loosen the four handlebar bolts.
3. Adjust the handlebar to the desired height. Be sure the handlebars do not contact the gas tank or any other part of the machine when turned fully to the left or right.
4. Torque the front two bolts to 10-12 ft-lbs (14-17 Nm), then torque the rear two bolts. A gap of up to 1/8" (3 mm) will remain at the rear of the clamp blocks.
5. Reinstall the headlight pod.

## **CLEANING AND STORAGE**

### **WASHING THE VEHICLE**

If a high pressure water system is used for cleaning (not recommended), exercise extreme caution. The water may damage components and could remove paint and decals. Avoid directing the water stream at the following items:

- Wheel bearings
- Radiator
- Transmission seals
- Cab and body panels
- Electrical components
- Switches and controls

- Fuel system components
- Labels and decals

If an informational or graphic label becomes illegible or comes off, contact your POLARIS dealer to purchase a replacement. Replacement safety labels are provided by POLARIS at no charge.

Grease all zerk fittings immediately after washing. Allow the engine to run for a while to evaporate any water that may have entered the engine or exhaust system.

### **WASHING TIPS**

- Avoid the use of harsh cleaners, which can scratch the finish.
- Do not use a power washer to clean the vehicle.
- Do not use medium to heavy duty compounds on the finish.
- Always use clean cloths and pads for cleaning and polishing. Old or reused cloths and pads may contain dirt particles that will scratch the finish.

### **POLISHING THE VEHICLE**

POLARIS recommends the use of common household aerosol furniture polish for polishing the finish on your POLARIS vehicle. Follow the instructions on the container

### **POLISHING TIPS**

- Avoid the use of automotive products, some of which can scratch the finish of your vehicle.
- Always use clean cloths and pads for cleaning and polishing. Old or reused cloths and pads may contain dirt particles that will scratch the finish.

### **STORAGE TIPS**

#### **CLEAN THE EXTERIOR**

Make any necessary repairs and clean the vehicle as recommended. See the Washing the Vehicle section.

#### **STABILIZE THE FUEL**

1. Fill the fuel tank.
2. Add POLARIS Carbon Clean Fuel Treatment or POLARIS Fuel Stabilizer or equivalent fuel treatments or stabilizers. Follow the instructions on the container for the recommended amount. Carbon Clean removes water from fuel systems, stabilizes fuel and removes carbon deposits from pistons, rings, valves and exhaust systems.
3. Allow the engine to run for 15-20 minutes to allow the stabilizer to disperse through the entire fuel delivery system.

#### **OIL AND FILTER**

Change the oil and filter. See the Engine Oil section.

## **AIR FILTER / AIR BOX**

Replace the air filter. See Maintenance Chapter. Clean the air box.

## **FLUID LEVELS**

Inspect the fluid levels. Add or change fluids as recommended in the Periodic Maintenance Chart.

- Demand drive fluid (front gearcase)
- Rear gearcase fluid (if equipped)
- Transmission fluid
- Brake fluid (change every two years and any time the fluid looks dark or contaminated)
- Coolant (test strength/fill)

## **INSPECT AND LUBRICATE**

Inspect all cables and lubricate all areas of the vehicle as recommended in the Periodic Maintenance Chart.

## **FOG THE ENGINE**

1. Treat the fuel system with POLARIS Carbon Clean or other equivalent fuel treatment. Follow the instructions on the container. Start the engine. Allow it to idle for several minutes so the Carbon Clean reaches the injectors. Stop the engine.
2. Remove the spark plugs and add 1–1.5 oz. (29.5–44 cc.) of engine oil. To access the plug holes, use a section of clear 6 mm (1/4") hose and a small plastic squeeze bottle filled with the pre-measured amount of oil. Do this carefully! If you miss the plug holes, oil will drain from the spark plug cavities into the hole at the front of the cylinder head, and appear to be an oil leak.
3. Reinstall the spark plugs. Torque to specification.
4. Apply dielectric grease to the inside of each spark plug cap. Do not reinstall the cap onto the plug at this step.
5. Turn the engine over several times. Oil will be forced in and around the piston rings and ring lands, coating the cylinder with a protective film of fresh oil.
6. Reinstall the spark plug caps.
7. If POLARIS fuel system additive is not used, fuel tank, fuel lines, and injectors should be completely drained of gasoline.

## **BATTERY MAINTENANCE**

See the Battery Storage and Battery Charging sections for storage and charging procedures

## **STORAGE AREA / COVERS**

Be sure the storage area is well ventilated. Cover the vehicle with a genuine POLARIS cover. Do not use plastic or coated materials. They do not allow enough ventilation to prevent condensation, and may promote corrosion and oxidation.

## TRANSPORTING THE ATV

Follow these procedures when transporting the vehicle.

1. Stop the engine.
2. Place the transmission in PARK.
3. Lock the parking brake.
4. Secure the fuel cap, oil cap and seats.
5. Always tie the frame of the ATV to the transporting unit securely with suitable straps or rope. Do not attach tie straps to the front A- arm bolt pockets, racks or handlebars.
6. Remove the key to prevent loss during transporting.

## SPECIFICATIONS

SPORTSMAN 570 / 570 EPS	
Maximum Weight Capacity	485 lbs. (220 kg) (operator, cargo, accessories)
Dry Weight	570: 677 lbs. (307 kg) 570 EPS: 690 lbs. (313 kg)
Fuel Capacity	4.5 gal. (17 l)
Engine Oil Capacity	2 qts. (1.9 l)
Coolant Capacity	2.7 qts. (2.5 l)
Rear Gearcase Oil Capacity	7.1 oz. (210 ml)

<b>SPORTSMAN 570 / 570 EPS</b>	
Demand Drive Fluid Capacity	9 oz. (265 ml)
Transmission Oil Capacity	32 oz. (948 ml)
Front Rack/Storage Box Capacity	90 lbs. (40.8 kg)
Rear Rack Capacity	180 lbs. (81.6 kg)
Receiver Hitch Tongue Capacity	120 lbs. (55 kg)* *Rear rack capacity and tongue weight not to exceed 180 lbs./81.6 kg
Hitch Towing Rating	1225 lbs. (557 kg)
Unbraked Trailer Towing Capacity (Based on EU Directive 76/432/EC)	1786 lbs. (810 kg)
Front Hitch Maximum Towed Load (Level Ground)	850 lbs. (386 kg)
Front Maximum Vertical Hitch Weight	85 lbs. (39 kg)
Overall Length	83 in. (211 cm)
Overall Width	48 in. (122 cm)
Overall Height	48 in. (122 cm)
Wheelbase	50.5 in. (128.3 cm)
Ground Clearance	11 in. (28 cm)

Minimum Turning Radius	65 in. (165 cm) unloaded
Engine	Dual overhead cam, 4 valve 4 stroke single cylinder
Displacement	567 cc
Bore x Stroke	99mm x 73.6mm
Alternator Output	560 W @ 7000 RPM
Compression Ratio	10:1
Starting System	Electric
Ignition System	ECU
Idle RPM	1200 +/- 50
Spark Plug Type / Gap	MR7F / 0.7-0.8 mm

SPORTSMAN 570 / 570 EPS	
Lubrication System	Wet Sump
Driving System Type	Automatic PVT (POLARIS Variable Transmission)
Front Suspension	MacPherson strut with 8.2" (21 cm) travel
Rear Suspension	Linear rate with 9.5" (24 cm) travel
Transmission	H/L/N/R/P
Gear Reduction, Low	23.91:1
Gear Reduction, Reverse	21.74:1
Gear Reduction, Forward	9.75:1
Drive Ratio, Front	3.82:1
Drive Ratio, Rear	3.7:1
Tires/Pressure, Front	25x8-12 / 7 psi (48.3 kPa)
Tires/Pressure, Rear	25x10-12 / 7 psi (48.3 kPa) (570) 25x11-12 / 7 psi (48.3 kPa) (570 EPS/LE)
Brakes, Front/Rear	Single-Control Hydraulic Disc
Brakes, Auxiliary	Foot-Activated Hydraulic Disc
Brake, Parking	Hydraulic lock, all wheel
Headlight	1 Single Beam on Headlight Pod (50 watt) 2 Single Beam on Bumper (50 watt)

Taillights	8.26 watts
Brake Light	26.9 watts
Instrument Cluster	LCD

## CLUTCHING

ALTITUDE		SHIFT WEIGHT	DRIVE CLUTCH SPRING	DRIVEN CLUTCH SPRING	HELIX*
Meters (Feet)	0-1800 (0-6000)	25-52G PN 5632409	EBS Black PN 7043595  NON-EBS Black PN 7043594	EBS RED PN 3234452  NON-EBS PN 7041782	EBS PN 3224356  NON-EBS PN 5132344

ALTITUDE		SHIFT WEIGHT	DRIVE CLUTCH SPRING	DRIVEN CLUTCH SPRING	HELIX*
	1800-3700 (6000-12000)	25-48 PN 5633217	Black PN 7043594	Non-EBS Red PN 3234451	Non-EBS PN 5132344
*EBS models require no helix/spring adjustment					



# TROUBLESHOOTING

## DRIVE BELT WEAR/BURN



POSSIBLE CAUSE	SOLUTION
Driving onto a pickup or tall trailer in high range	Use low range during loading.
Starting out going up a steep incline	Use low range.
Driving at low RPM or ground speed (3-7 MPH)	Drive at a higher speed or use low range more frequently.
Insufficient warm-up at low ambient temperatures	Warm the engine at least 5 minutes. With the transmission in neutral, advance the throttle to about 1/8 throttle in short bursts, 5 to 7 times. The belt will become more flexible and prevent belt burning.
Slow/easy clutch engagement	Use the throttle quickly and effectively.
Towing/pushing at low RPM/ low ground speed	Use low range only.
Utility use/plowing	Use low range only.
Stuck in mud or snow	<p>Shift the transmission to low range and carefully use fast, aggressive throttle application to engage clutch.</p> <p>WARNING: Excessive throttle may cause loss of control and vehicle rollover.</p>
Climbing over large objects from a stopped position	<p>Shift the transmission to low range and carefully use fast, brief, aggressive throttle application to engage clutch.</p> <p>WARNING: Excessive throttle may cause loss of control and vehicle rollover.</p>



Belt slippage from water or snow ingestion into the PVT system	Dry out the PVT. Prevent water from entering the PVT intake duct. See Intake Pre-Filters for more information. Inspect clutch seals for damage if repeated leaking occurs.
Clutch malfunction	An authorized dealer can assist.
Poor engine performance	Check for fouled plug or foreign material in gas tank or fuel lines. An authorized dealer can assist.
Slippage from failure to warm up belt	Always warm up the belt by operating below 30 mph for one mile (5 miles or more when temperature is below freezing).
Wrong or missing belt	Install the recommended belt.
Improper break-in	Always break in a new belt and/or clutch.

## ENGINE DOESN'T TURN OVER

POSSIBLE CAUSE	SOLUTION
Low battery voltage	Recharge the battery to 12.8 VDC
Loose battery connections	Check all connections and tighten
Loose solenoid connections	Check all connections and tighten
Loose electronic control box connections	Inspect, clean, reinstall connectors

## ENGINE TURNS OVER, FAILS TO START

POSSIBLE CAUSE	SOLUTION
Out of fuel	Refuel
Water is present in fuel	Drain the fuel system and refuel
Old or non-recommended fuel	Replace with fresh recommended fuel
Fouled or defective spark plug	Inspect plug and replace if necessary
No spark to spark plug	Inspect plug and replace if necessary
Water or fuel in crankcase	Your authorized dealer can assist
Low battery voltage	Recharge the battery to 12.8 VDC
Mechanical failure	Your authorized dealer can assist



## ENGINE BACKFIRES

<b>POSSIBLE CAUSE</b>	<b>SOLUTION</b>
Weak spark from spark plug	Inspect, clean and/or replace spark plug
Incorrect spark plug gap or heat range	Set gap to specs or replace plug
Old or non-recommended fuel	Replace with fresh recommended fuel
Incorrectly installed spark plug wires	Your authorized dealer can assist
Mechanical failure	Your authorized dealer can assist
Loose ignition connections	Check all connections and tighten
Water present in fuel	Replace with fresh recommended fuel

## ENGINE PINGS OR KNOCKS

<b>POSSIBLE CAUSE</b>	<b>SOLUTION</b>
Poor quality or low octane fuel	Replace with recommended fuel
Incorrect spark plug gap or heat range	Set gap to specs or replace plug

## ENGINE RUNS IRREGULARLY, STALLS OR MISFIRES

POSSIBLE CAUSE	SOLUTION
Fouled or defective spark plug	Inspect, clean and/or replace spark plug
Worn or defective spark plug wires	Your authorized dealer can assist
Incorrect spark plug gap or heat range	Set gap to specs or replace plug
Loose ignition connections	Check all connections and tighten
Water present in fuel	Replace with new fuel
Low battery voltage	Recharge battery to 12.8 VDC
Incorrect fuel	Replace with recommended fuel
Clogged air filter	Inspect and clean or replace
Clogged intake pre-filter	Inspect and clean (with soapy water) or replace
Other mechanical failure	Your authorized dealer can assist



## ENGINE STOPS OR LOSES POWER



<b>POSSIBLE CAUSE</b>	<b>SOLUTION</b>
Out of fuel	Refuel
Kinked or plugged fuel vent line	Inspect and replace
Water is present in fuel	Replace with new fuel
Fouled or defective spark plug	Inspect, clean and/or replace spark plug
Worn or defective spark plug wires	Your authorized dealer can assist
Incorrect spark plug gap or heat range	Set gap to specs or replace plug
Loose ignition connections	Check all connections and tighten
Low battery voltage	Recharge the battery to 12.8 VDC
Incorrect fuel	Replace with fresh recommended fuel
Clogged air filter	Inspect and clean or replace
Clogged intake pre-filter	Inspect and clean (with soapy water) or replace
Other mechanical failure	Your authorized dealer can assist



Overheated engine	Clean radiator screen and core, clean engine exterior. Your dealer can assist.
-------------------	--

**Warning**

This content is compiled from multiple sources and is provided for reference purposes only. It may not be complete or fully applicable to all situations. If you are unable to resolve your issue, please contact the product manufacturer or an authorized service provider for official support.

