

Controls

Dispense Models

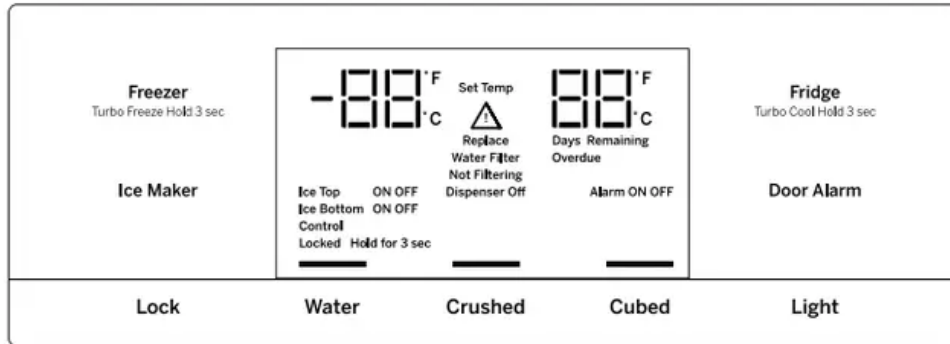

Non-dispense Models

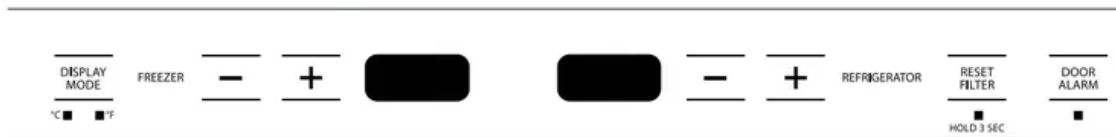

NOTE: The refrigerator is shipped with protective film covering the temperature controls. If this film was not removed during installation, remove it now.

The temperature controls are preset in the factory at 37°F (3°C) for the refrigerator compartment and 0°F (-18°C) for the freezer compartment. Allow 24 hours for the temperature to stabilize to the preset recommended settings.

The temperature controls display the SET temperature in the refrigerator and freezer. The actual temperature may vary slightly from the SET temperature based on usage and operating environment.

Changing the Temperature for Non-dispense Models

To change the temperature, press and release the To turn OFF cooling system, press and hold either (+)

(+) or (-) pad to the desired temperature set point for pad until both displays show OFF.

fresh food and freezer separately. Allow 24 hours for the refrigerator to reach the temperature you have set.

Changing the Temperature for Dispense Models

To change the temperature, press and release the Freezer or Fridge pad. The display will show the set temperature. To change the temperature, press either the Freezer or Fridge pad until the desired temperature is displayed.

To turn OFF cooling system, press and hold **Fridge** and **Ice Maker** simultaneously for 3 seconds. When the cooling system is OFF the display should read OFF. Not all features available on all models.

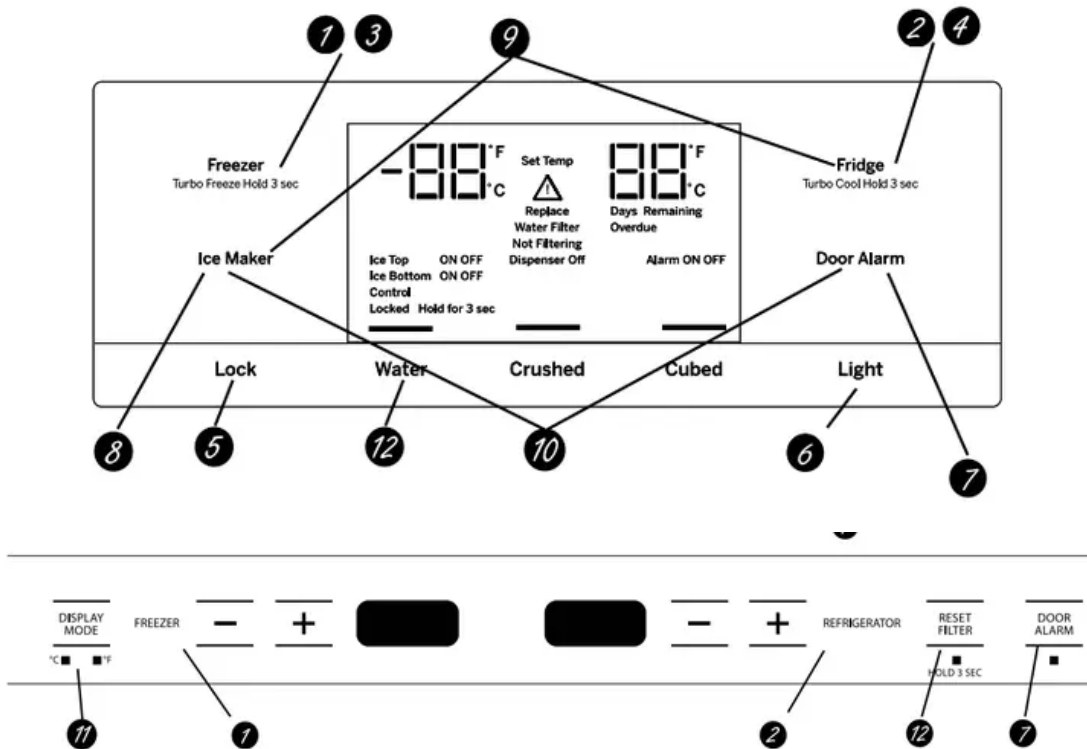

1. Refrigerator temp control

Adjust freezer compartment temperature.

2. Fresh food temp control

Adjust fresh food compartment temperature.

3. TurboFreeze™ setting

Activate TurboFreeze to quickly restore freezer temperatures after frequent door openings.

4. TurboCool™ setting

Activate TurboCool to quickly restore fresh food temperature after frequent door openings.

5. Lock controls

Press and hold 3 seconds to lock out ice and water dispenser and all feature and temperature buttons.

6. LED dispenser light

LED lighting that can be turned on/off to light your dispenser.

7. Door Alarm

Sounds to alert when the freezer or fresh food doors have been open for more than 2

minutes. Press and hold Door Alarm pad and it will toggle the sound between low, high and off.

8. Ice maker setting

Turn your ice makers on/off.

9. Cooling system On/Off

Press and hold Fridge & Ice Maker simultaneously for 3 seconds to turn the cooling system on or off.

10. Metric/English units

Press and hold Ice Maker & door alarm simultaneously for 3 seconds to switch between.

11. Display mode, °C/°F

Change temperature display between Fahrenheit and Celsius.

12. Reset water filter

Press and hold the RESET FILTER Button for non-dispense models or press and hold the WATER button for dispense models to reset the filter indicator.

Ice and Water Dispenser (On some models)

To dispense water or ice: select Water, Crushed, or Cubed.

Press the glass gently against the top of the dispenser cradle.

The drip tray is not self-draining. To reduce water spotting, the shelf and its grille should be cleaned regularly.

If no water is dispensed when the refrigerator is first installed, there may be air in the water line system. Press the dispenser cradle for at least two minutes to remove trapped air from the water line and to fill the water system. To flush out impurities in the water line, throw away the first gallon (3.8 liters) of water.

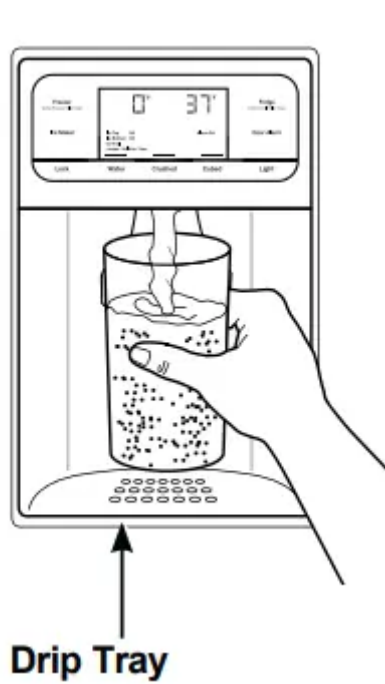

CAUTION

Never put fingers or any other objects into the ice crusher discharge opening.

Locking the Dispenser:

Touch Lock for 3 seconds to lock the dispenser and control pad. To unlock, touch Lock again for 3 seconds.

Light:

This feature turns the light on and off. The light also comes on when the dispenser cradle is pressed. If this light burns out, contact factory service.

Ice Storage Drawer on Dispenser Models

To remove:

Lift up the access door to reach the icemaker. Set the icemaker power switch to the OFF position. With the access door closed, support the storage bin at the bottom while slightly lifting. Pull bin straight out.

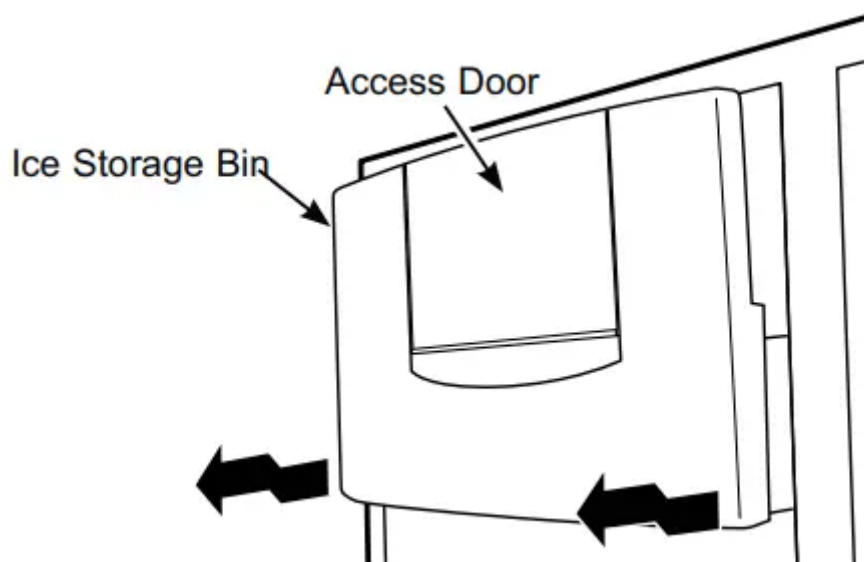

To replace:

Slide the bin back until the tab on the bin locks into the slot on the shelf. If the bin does not go all the way back, remove it and rotate the drive mechanism 1/4 turn. Then push the bin back again.

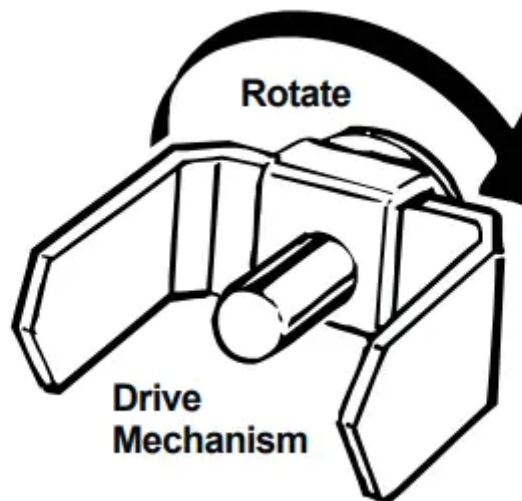

Important Facts About Your Dispenser

- Do not add ice from trays or bags to the storage bin. It may not crush or dispense well.
- Avoid overfilling glass with ice and use of narrow glasses. Backed-up ice can jam the chute or cause the door in the chute to freeze shut. If ice is blocking the chute, poke it through with a wooden spoon.
- Beverages and foods should not be quick-chilled in the ice storage bin. Cans, bottles or food packages in the storage bin may cause the icemaker or auger to jam.
- To keep dispensed ice from missing the glass, put the glass close to, but not touching, the dispenser opening.



- Some crushed ice may be dispensed even though you selected Cubed. This happens occasionally when a few cubes have been left in the crusher.
- After crushed ice is dispensed, some water may drip from the chute.
- Sometimes a small mound of snow will form on the door in the ice chute. This condition is normal and usually occurs when you have dispensed crushed ice repeatedly. The snow will eventually evaporate.
- The first glass of water dispensed may be warmer than the following ones. This is normal.
- Dispensed water is not ice cold. For colder water, simply add crushed ice or cubes before dispensing water.
- To eliminate drips on the drip tray, tilt the glass in slightly when dispensing water.

Automatic Icemaker

A newly-installed refrigerator may take 12-24 hours to begin making ice.

Automatic Icemaker

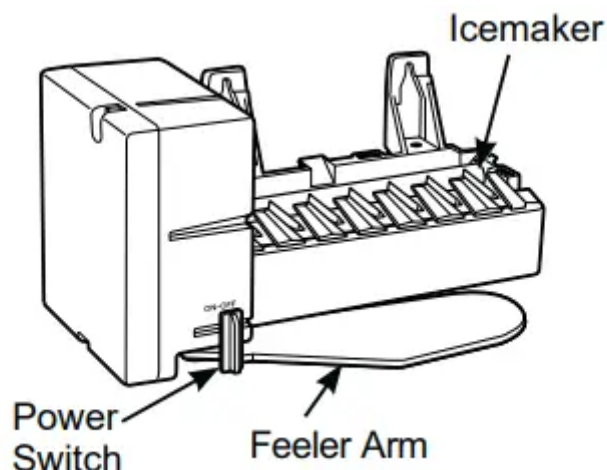

The icemaker will produce seven cubes per cycle- approximately 15 cycles in a 24-hour period, depending on freezer compartment temperature, room temperature, number of door openings and other use conditions.

If the refrigerator is operated before the water connection is made to the icemaker, set the power switch on the icemaker to OFF.

When the refrigerator has been connected to the water supply, set the power switch on the icemaker to ON.

For dispense models, the icemaker can be turned on and off using the power switch on the icemaker or by using the Ice Maker button on the control panel. If you use the control panel to turn the icemaker off you will have to use the control panel to turn it back on. The same is true for the power switch on the icemaker.

CAUTION

Avoid contact with the moving parts of the ejector mechanism, or with the heating element (located on the bottom of the ice maker) that releases the cubes. Do not place fingers or hands on the automatic ice making mechanism while the refrigerator is plugged in.

Important Facts About Your Icemaker

- You may hear a buzzing sound each time the icemaker fills with water.
- Throw away the first few batches of ice to allow the water line to clear.
- Be sure nothing interferes with the sweep of the feeler arm.
- When the bin fills to the level of the feeler arm, the icemaker will stop producing ice. It is normal for several cubes to be joined together.
- If ice is not used frequently, old ice cubes will become cloudy, taste stale and shrink.

NOTE: In homes with lower-than-average water pressure, you may hear the icemaker cycle multiple times when making one batch of ice. Icemaker works best between 40 and 120 psi (275-827 kPa).

Water Filter Cartridge (On some models.)

Water filter cartridge

The water filter cartridge is located behind the upper cover at the top of the refrigerator.

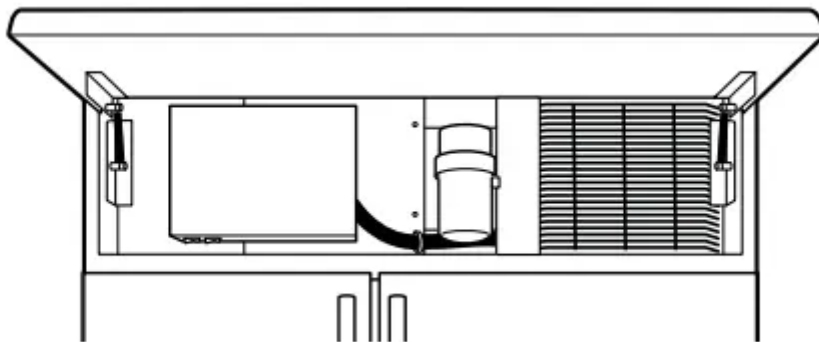

When to replace the filter on models with a replacement indicator light

There is a replacement indicator light for the water filter cartridge on the dispenser. This light will turn orange to tell you that you need to replace the filter soon.

The filter cartridge should be replaced when the replacement indicator light turns red or if the flow of water to the dispenser or icemaker decreases.

Dispense Models

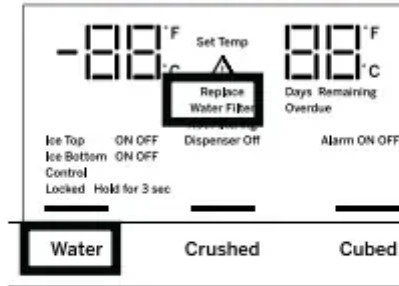

Non-Dispense Models



Removing the filter cartridge

If you are replacing the cartridge, first remove the old one by slowly turning it to the left. Do not pull down on the cartridge. A small amount of water may drip down.

NOTE: To reduce the risk associated with property damage due to water leakage, read and follow instructions before installation and use of this system.

Installation and use **MUST** comply with all state and local plumbing codes.

Installing the filter cartridge

1. Fill the replacement cartridge with water from the tap to allow for better flow from the dispenser immediately after installation.
2. Line up the arrow on the cartridge and the cartridge holder. Place the top of the new cartridge up inside the holder. Do not push it up into the holder.
3. Slowly turn it to the right until the filter cartridge stops. **DO NOT OVERTIGHTEN**. As you turn the cartridge it will automatically raise itself into position. The cartridge will move about a 1/2 turn.

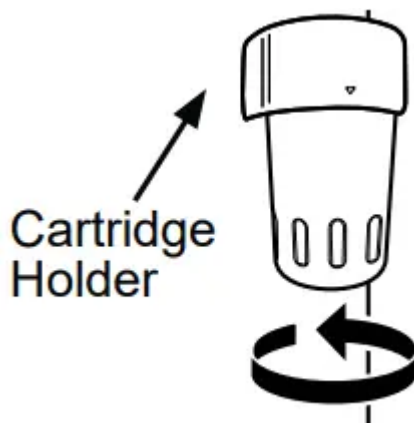

4. Run water from the dispenser for 1-1/2 gallons (5.7 liters) (about three minutes) to clear the system and prevent sputtering.

5. Press and hold the RESET FILTER Button for non-dispense models or press and hold the WATER button for dispense models to reset the filter indicator.

NOTE: A newly installed water filter cartridge may cause water to spurt from the dispenser.

Filter bypass plug

You must use the filter bypass plug when a replacement filter cartridge is not available. The dispenser and the icemaker will not operate without the filter or filter bypass plug.

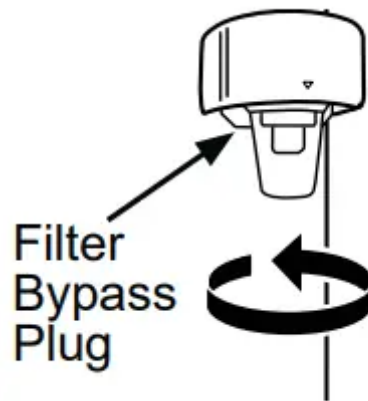

WARNING

To reduce the risk associated with choking, do not allow children under 3 years of age to have access to small parts during the installation of this product.

The disposable filter cartridge should be replaced every 6 months at the rated capacity, or sooner if noticeable reduction in flow rate occurs.

For the maximum benefit of your filtration system, GE Appliances recommends the use of GE Appliances-branded filters only. Using GE Appliances-branded filters in GE Appliances and Hotpoint refrigerators provides optimal performance and reliability. GE Appliances filters meet rigorous industry NSF standards for safety and quality that are important for products that are filtering your water. GE Appliances has not qualified non-GE Appliances branded filters for use in GE Appliances and Hotpoint refrigerators and there is no assurance that non-GE Appliances branded filters meet GE Appliances standards for quality, performance and reliability.

If you have questions, or to order additional filter cartridges, visit our website at gewaterfilters.com or call GE Appliances Parts and Accessories, 877.959.8688. In Canada, call 800.661.1616.

Climate Control Drawer

The Climate Control feature is a system of dampers, a fan, a temperature thermistor, and a heater. The Climate Control drawer can be used to store items at their optimum temperatures. The drawer is tightly sealed to prevent the drawer's temperature from causing temperature fluctuations in the rest of the refrigerator.

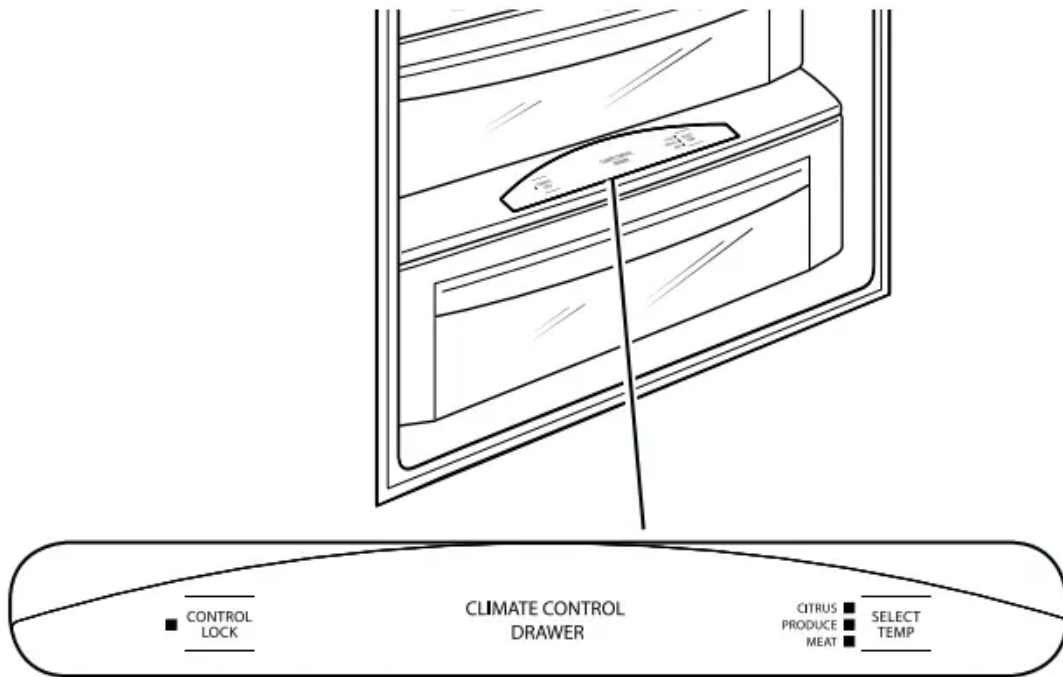

SELECT TEMP—Use this feature to store items at their optimum temperatures. See Climate Control Chart below.

CONTROL LOCK—Use this feature to lock the temperature controls.

NOTE: When the controls on the Climate Control drawer are turned off, the drawer will maintain temperatures at 42-48°F (5.6-8.9°C).

Climate Control Chart

NOTE: Results may vary depending on packaging, starting produce temperature and other food traits. meat

Citrus Setting (39–47°F) (3.9-8.3°C)
Oranges, Lemons, Limes, Pineapple, Cantaloupe
Beans, Cucumbers, Tomatoes, Peppers, Eggplant, Squash
Produce Setting (31–38°F) (-0.6 - 3.3°C)
Strawberries, Raspberries, Kiwifruit, Pears, Cherries, Blackberries, Grapes, Plums, Nectarines, Apples
Asparagus, Broccoli, Corn, Mushrooms, Spinach, Cauliflower, Kale, Green Onions, Beets, Onions
Meat Setting (27–37°F) (-2.8 - 2.8°C)
Raw Meat, Fish and Poultry

Control Lock

Press and hold this pad for 3 seconds to lock the settings for the Climate Control drawer. To unlock, press and hold for another 3 seconds.

Storage Drawers

Sealed Deli Pan

Use the Sealed Deli Pan for the convenient storage of lunch meats and cheese, hors d'oeuvres, spreads and snacks. The pan and shelf to which it is attached can be adjusted to any height. Excess water that may accumulate in the bottom of the drawers should be emptied and the drawers wiped dry.

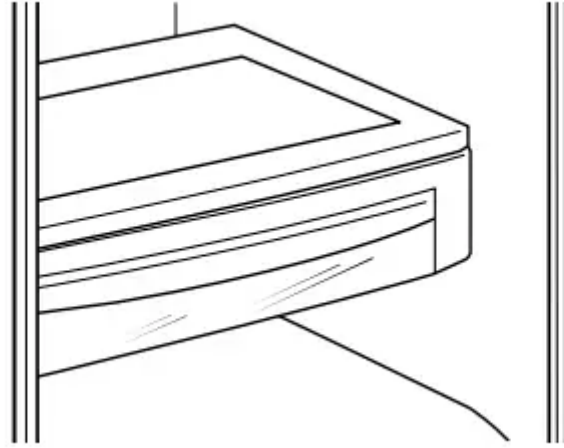

Sealed Produce Pan

The top pan is designed to provide constant high humidity levels.

Make sure the drawers are closed completely to maintain the correct humidity level.

Excess water that may accumulate in the bottom of the drawers should be emptied and the drawers wiped dry.

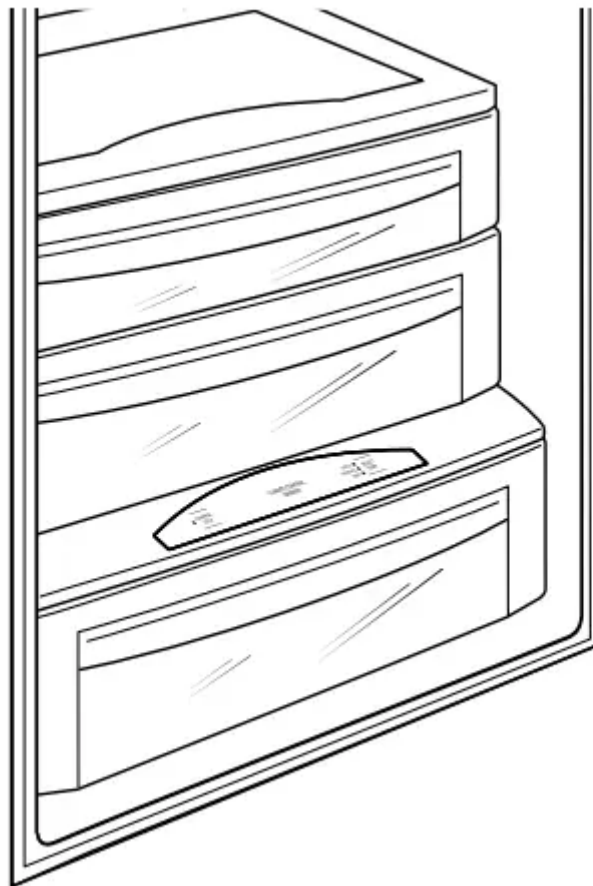

Drawer/Pan Removal

To remove a drawer/pan:

1. Pull the drawer/pan out to the stop position.
2. Lift the front of the drawer/pan up and out of the wire holder.
3. Lift the back of the drawer/pan up and out.

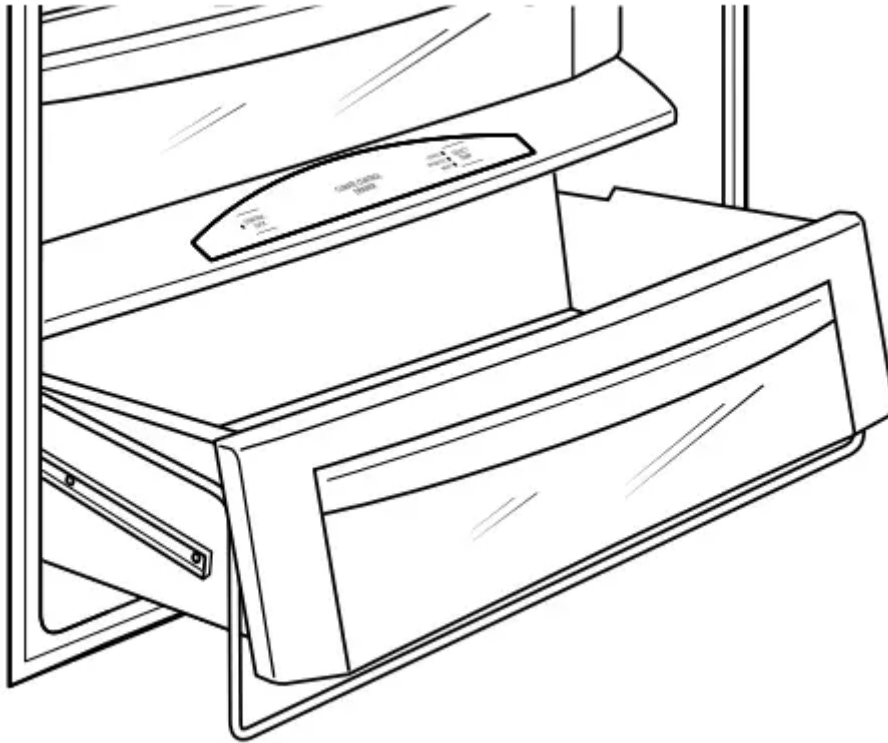

To replace a drawer/pan:

1. Place the back of the drawer/pan in the wire holder, making sure the wire holder fits into the grooves on the back of the drawer/pan.
2. Lower the front of the drawer/pan into the wire holder.
3. Press firmly on the top of the drawer/pan to snap it into the wire holder.

Shelves

Lighted Vegetable Drawer Shelf

The lighted vegetable drawer shelf provides lighting for the lower compartments. The lights are recessed into the shelf to illuminate the drawers below.

To remove shelf:

1. Remove the top drawer (see Drawer/pan removal section).

2. Push down gently on the back center of the climate control drawer top surface to release the bottom of the water tank cover. Pull out and down to remove the water tank cover and expose the wire harness.
3. Lift the shelf and carefully pull forward to expose the wires.
4. Unplug the shelf and carefully remove it from the refrigerator.

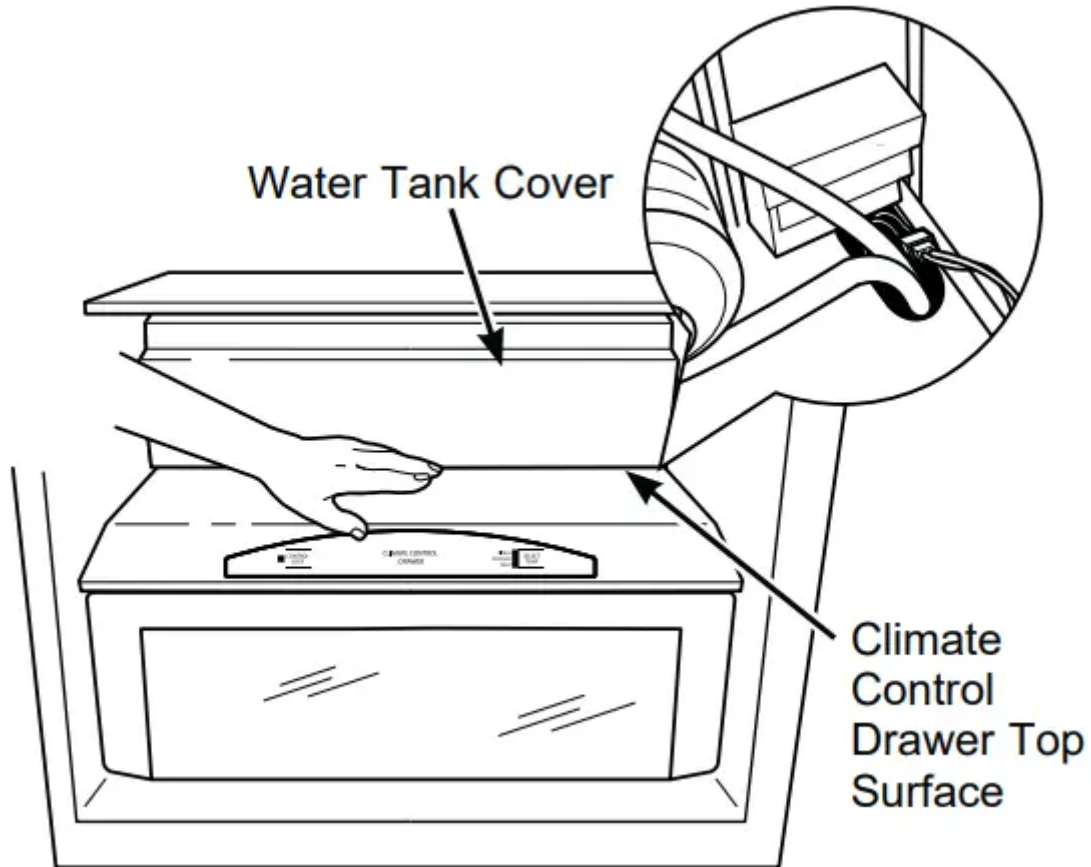

To replace shelf:

1. Carefully set the shelf onto the side rails, leaving the plug exposed.
2. Plug the shelf into the refrigerator.
3. Carefully slide the shelf into place.
4. Insert the water tank cover top first so that it goes up behind the gasket hanging down from the vegetable drawer shelf. Gently push the bottom of the water tank cover until the bottom snaps into the the top of the Climate Control Drawer cover.
5. Replace the drawer (see Drawer/pan removal section).

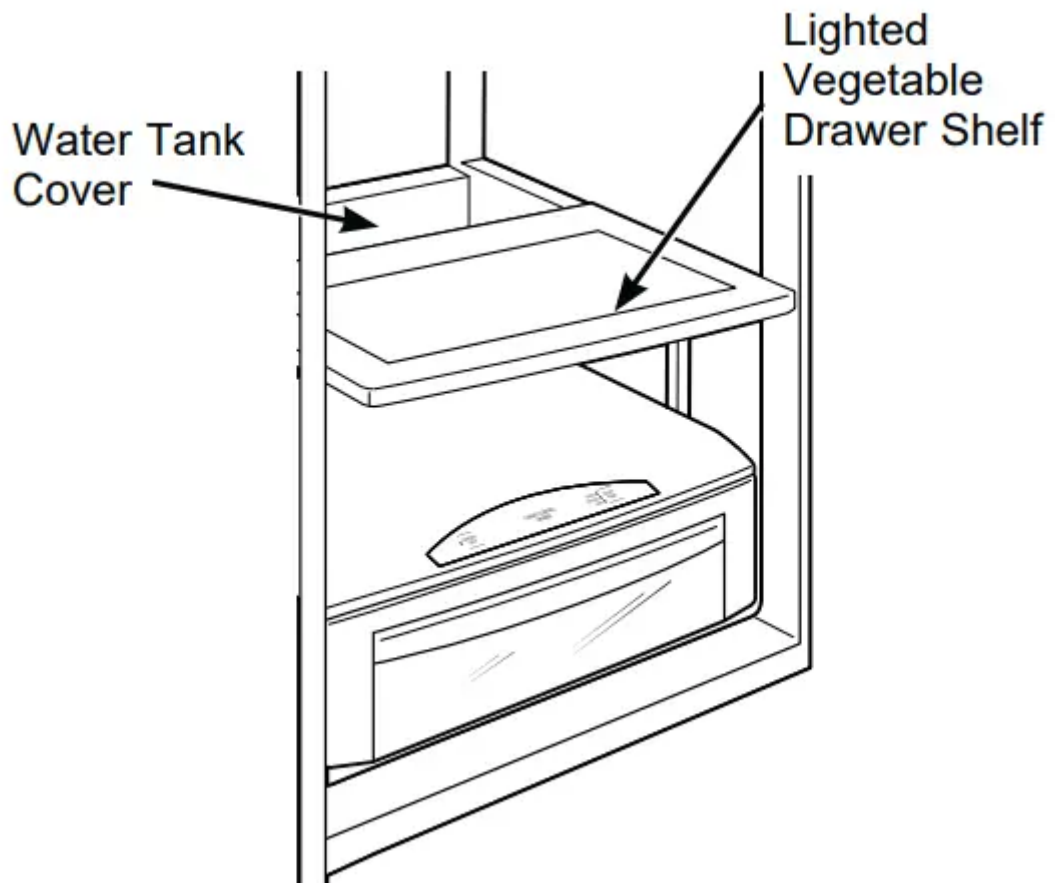

To rearrange shelves

Tempered glass shelves in the fresh food compartment and wire shelves in the freezer compartment are adjustable, enabling you to make efficient shelf arrangements to fit your family's food storage needs.

To remove shelves:

Tilt shelf up at front, then lift it up and out of tracks on rear wall of refrigerator.

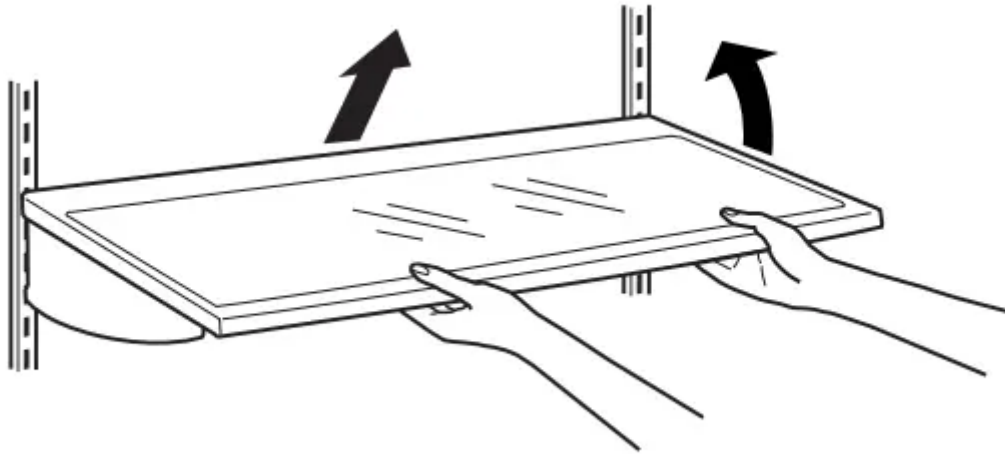

To replace shelves:

Select desired shelf height. With shelf front raised slightly, engage top lugs in tracks at rear of cabinet. Then lower front of shelf until it locks into position.

CAUTION

Handle glass shelves carefully. Glass shelves and covers may break if exposed to impact, such as bumping or dropping. Tempered glass is designed to shatter into many small pieces if it breaks.

Bins and Baskets

Door bins

All door bins, except for the deep gallon door bin, are adjustable using one of 2 tabs on each end of the bin. They can be moved up and down to many different positions to meet your storage needs. The deep gallon door bin can be removed for cleaning.

To remove any bin:

Lift the bin up and slide it toward you.

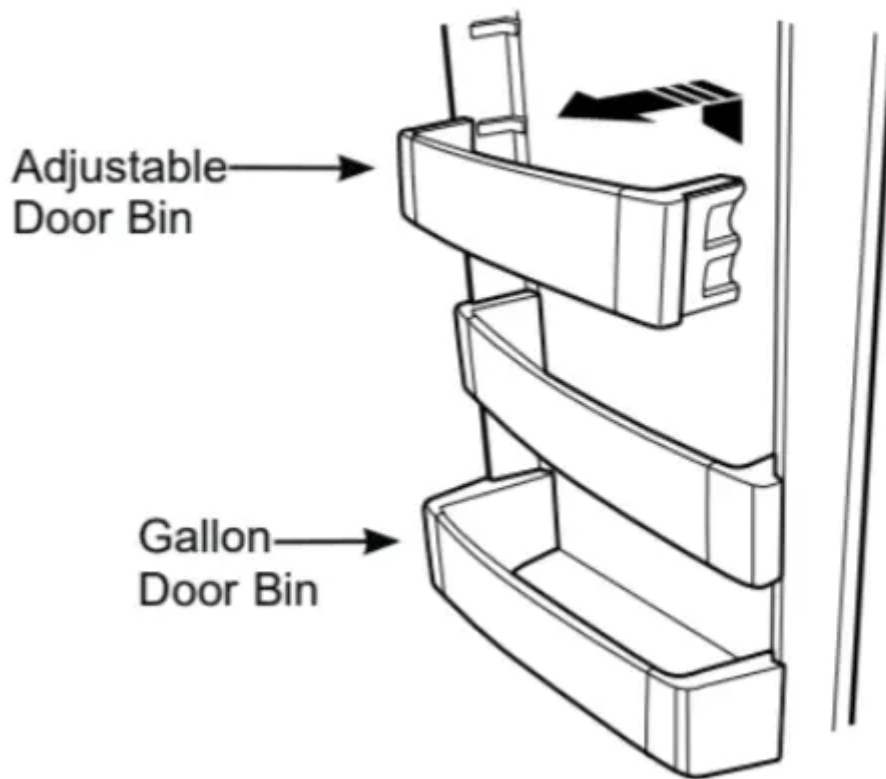

Freezer baskets

Wire slide-out freezer baskets can be pulled out for easy access to frozen foods.

To remove:

Pull basket out. Lift the front of the basket up and then take it out.

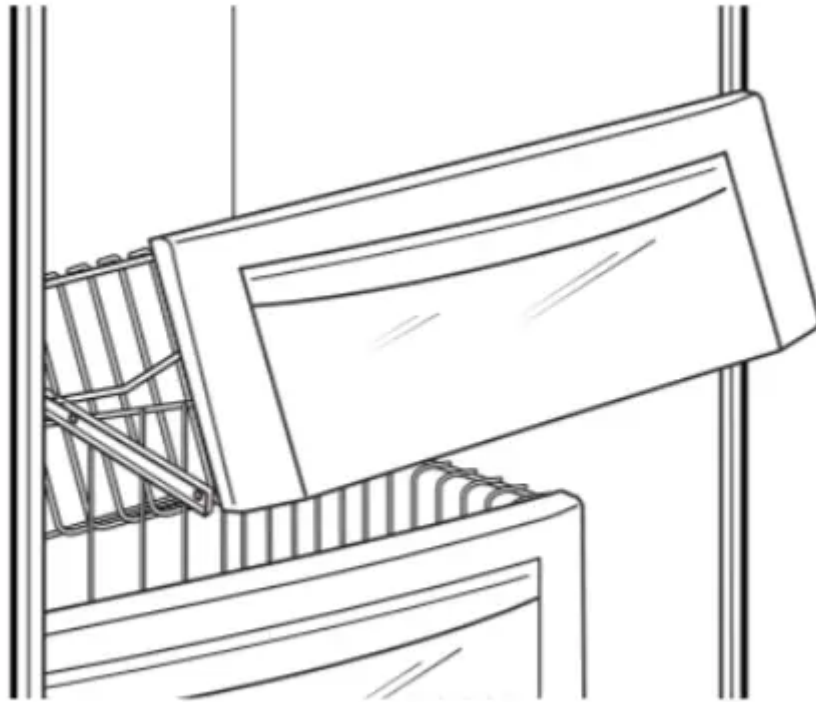

Care and Cleaning

Cleaning the Outside

The stainless steel panels, door handles and trim. The stainless steel doors and door handles can be cleaned with a commercially available stainless steel cleaner. Cleaners with oxalic acid such as Bar Keepers Friend Soft Cleanser™ will remove surface rust, tarnish and small blemishes. Use only a liquid cleanser free of grit and rub in the direction of the brush lines with a damp soft sponge. Do not use appliance wax or polish on the stainless steel.

Silver-accented plastic parts.

Wash parts with soap or other mild detergents. Wipe clean with a sponge, damp cloth or paper towel.

Do not use scouring pads, powdered cleaners, bleach or cleaners containing bleach because these products can scratch and weaken the paint finish.

Should drip tray need cleaning use lime remover.

Cleaning the Inside

To help prevent odors, leave an open box of baking soda in the refrigerator and freezer compartments. **Unplug the refrigerator before cleaning.**

If this is not practical, wring excess moisture out of sponge or cloth when cleaning around switches, lights or controls. Use an appliance wax polish on the inside surface between the doors.

Use warm water and baking soda solution—about a tablespoon (15 ml) of baking soda to a quart (1 liter) of water. This both cleans and neutralizes odors. Rinse and wipe dry.

Do not clean glass shelves or covers with warm water when they are cold. Glass shelves and covers may break if exposed to sudden temperature changes or impact such as bumping or dropping. Tempered glass is designed to shatter into many small pieces if it breaks. Do not wash any plastic refrigerator parts in the dishwasher.

Behind the Refrigerator

Be careful when moving the refrigerator away from the wall. All types of floor coverings can be damaged, particularly cushioned coverings and those with embossed surfaces.

Raise the leveling legs located at the bottom front of the refrigerator.

Pull the refrigerator straight out and return it to position by pushing it straight in. Moving the refrigerator in a side direction may result in damage to the floor covering or refrigerator.

Lower the leveling legs until they touch the floor.

When pushing the refrigerator back, make sure you don't roll over the power cord or water supply line.

Preparing for Vacation

Set the icemaker power switch to the OFF position and be sure to shut off the water supply to the refrigerator.

For long vacations or absences, remove food from the refrigerator/freezer. Set the control to OFF, and clean the interior with a baking soda solution of one tablespoon (15 ml) of baking soda to one quart (1 liter) of water. Leave the door open.

For shorter vacations, remove perishable foods and leave controls at regular settings. However, if the room temperature is expected to drop below 60°F (16°C), follow the same instructions as for long vacations.

Replacing the Lights

The columns along the back wall of the fresh food and freezer compartments are lit up by LED lights located behind the top pan in the fresh food compartment and the bottom basket in the freezer compartment.

An authorized technician will need to replace the LED light.

If this assembly needs to be replaced, call GE Appliances Service at 1.800.432.2737 in the United States or 1.800.561.3344 in Canada.

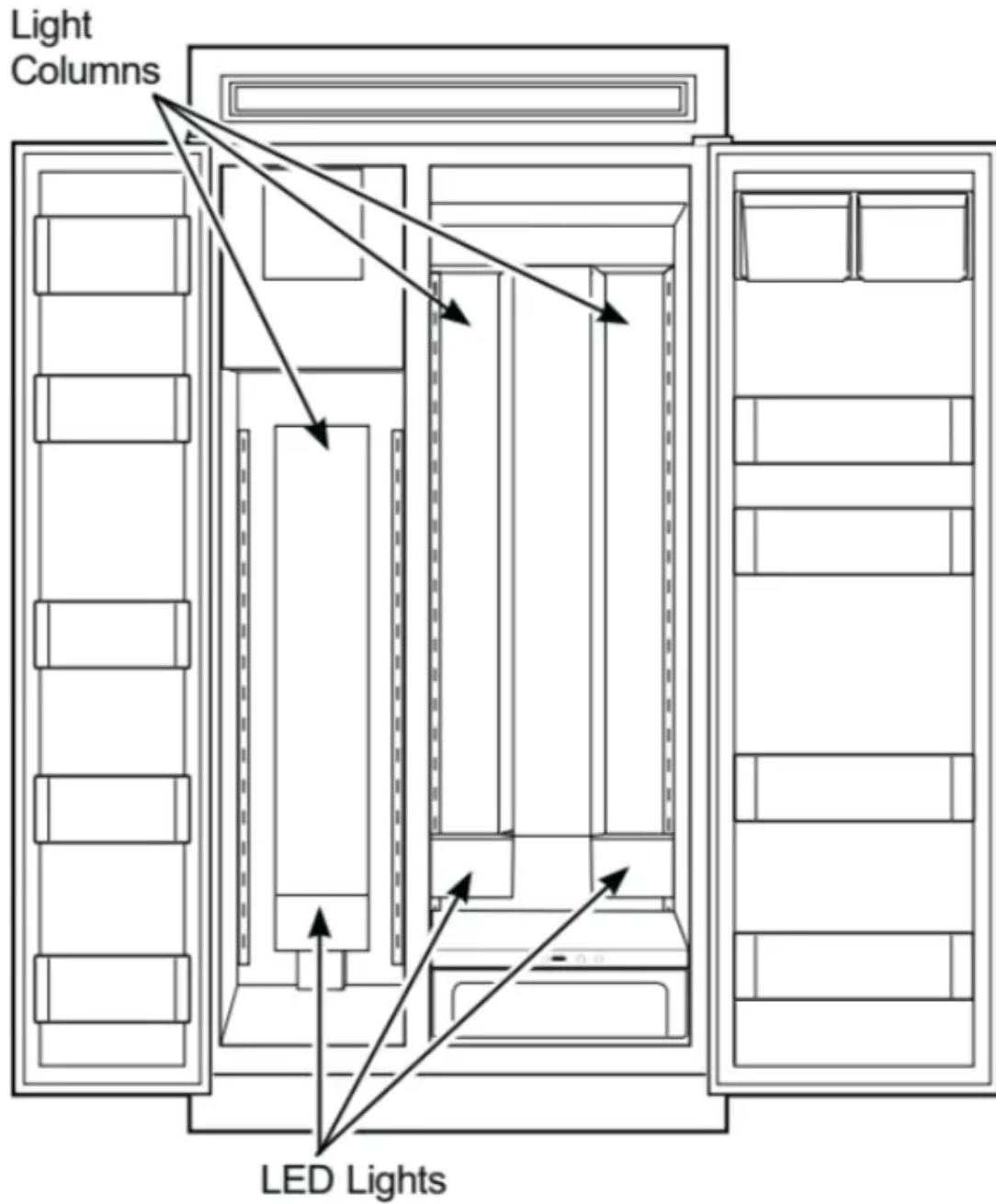

NORMAL OPERATING CONDITIONS

Newer refrigerators sound different from older refrigerators. Modern refrigerators have more features and use newer technology.

Do you hear what I hear? These sounds are normal.

HUMMM...

^WHOOSH...

- The new high efficiency compressor may run faster and longer than your old refrigerator and you may hear a high-pitched hum or pulsating sound while it is operating.
- Sometimes the refrigerator runs for an extended period, especially when the doors are opened frequently. This means that the Frost Guard™ feature is working to prevent freezer burn and improve food preservation.
- You may hear a whooshing sound when the doors close. This is due to pressure equalizing within the refrigerator.

CLICKS, POPS, CRACKS and CHIRPS

- You may hear cracking or popping sounds when the refrigerator is first plugged in. This happens as the refrigerator cools to the correct temperature.
- Electronic dampers click open and closed to provide optimal cooling and energy savings.
- The compressor may cause a clicking or chirping sound when attempting to restart (this could take up to 5 minutes).
- The electronic control board may cause a clicking sound when relays activate to control refrigerator components.
- Expansion and contraction of cooling coils during and after defrost can cause a cracking or popping sound.
- On models with an icemaker, after an icemaking cycle, you may hear the ice cubes dropping into the ice bucket.

WHIR!

- You may hear the fans spinning at high speeds. This happens when the refrigerator is first plugged in, when the doors are opened frequently or when a large amount of food is added to the refrigerator or freezer compartments. The fans are helping to maintain the correct temperatures.
- If either door is open for over 3 minutes, you may hear the fans come on in order to cool the light bulbs.
- The fans change speeds in order to provide optimal cooling and energy savings.

WATER SOUNDS

- The flow of refrigerant through the freezer cooling coils may make a gurgling noise like boiling water.

- Water dropping on the defrost heater can cause a sizzling, popping or buzzing sound during the defrost cycle.
- A water dripping noise may occur during the defrost cycle as ice melts from the evaporator and flows into the drain pan.
- Closing the door may cause a gurgling sound due to pressure equalization.



TROUBLESHOOTING TIPS

Problem	Possible Causes	What To Do
Refrigerator does not operate	Refrigerator in defrost cycle.	Wait about 30 minutes for defrost cycle to end.
	Freezer control in 0 (off) position.	Move the freezer control to a lower temperature setting.
	Refrigerator is unplugged.	Push the plug completely into the outlet.
	The fuse is blown/circuit breaker is tripped.	Replace fuse or reset the breaker.
	Energy Smart™ feature is altering refrigerator performance	Wait about 2 hours for normal operation to continue.
Refrigerator or freezer compartment too warm	Temperature control not set cold enough.	See About the controls.
	Warm weather or frequent door openings.	Set the temperature control one step colder. See About the controls.
	Door left open.	Check to see if package is holding door open.
	Energy Smart™ feature is altering refrigerator performance	See About Energy Smart™ Models.
Vibration or rattling	Front rollers need adjusting.	See Rollers. Slight vibration is normal.
Motor operates for long periods or cycles on and off frequently. (Modern	Normal when refrigerator is first plugged in.	Wait 24 hours for the refrigerator to completely cool down.



refrigerators with more storage space and a larger freezer require more operating time. They start and stop often to maintain even temperatures.)		
	Often occurs when large amounts of food are placed in refrigerator.	This is normal.
	Door left open.	Check to see if package is holding door open.
	Hot weather or frequent door openings.	This is normal.
	Temperature controls set at the coldest setting.	See About the controls.
Frost or ice crystals on frozen food (frost within package is normal)	Door left open.	Check to see if package is holding door open.
	Too frequent or too long door openings.	
Divider between refrigerator and freezer compartments feels warm	Automatic energy saver system circulates warm liquid around front edge of freezer compartment.	This helps prevent condensation on the outside.
Automatic icemaker does not work (on some models)	Icemaker power switch is in the OFF position.	Slide the power switch to the ON position.
	Water supply turned off or not connected.	See Installing the water line.
	Freezer compartment too warm.	Wait 24 hours for the refrigerator to completely cool down.



	Piled up cubes in the storage bin cause icemaker to shut off.	Level cubes by hand.
	Ice cubes stuck in icemaker.	Turn off the icemaker, remove cubes and turn the icemaker back on.



Problem	Possible Causes	What To Do
Ice cubes have odor/ taste	Ice storage bin needs cleaning.	Empty and wash bin. Discard old cubes.
	Food transmitting odor/ taste to ice cubes.	Wrap foods well.
	Interior of refrigerator needs cleaning.	See Care and cleaning.
Small or hollow cubes	Water filter clogged.	Replace filter cartridge with new cartridge with plug.
Slow ice cube freezing	Door left open.	Check to see if package is holding door open.
	Temperature control not set cold enough.	See About the controls.
	Energy Smart™ feature is altering refrigerator performance	See About Energy Smart™ Models
Door not closing properly	Door gasket on hinge side sticking or folding over.	Apply petroleum jelly on face of gasket
Orange glow in freezer	Defrost heater is on.	This is normal.
Cube dispenser does not work (on some models)	Icemaker or water supply turned off.	Turn on icemaker or water supply.
	Ice cubes are frozen to icemaker feeler arm.	Remove cubes.

	Irregular ice clumps in storage container.	Break up with fingertip pressure and disperse remaining clumps.
		Freezer may be too warm. Adjust the freezer control to a colder setting, one position at a time, until clumps do not form.
	Dispenser is LOCKED.	Press and hold the Lock pad for 3 seconds.
Water has poor taste/odor (on some models)	Water dispenser has not been used for a long time.	Dispense water until all water in system is replenished.
Water in first glass is warm (on some models)	Normal when refrigerator is warm.	Wait 24 hours for the refrigerator to completely cool down.
	Water dispenser has not been used for a long time.	Dispense water until all water in system is replenished.
	Water system has been drained.	Allow several hours for replenished supply to chill.
Water dispenser does not work (on some models)	Water supply line turned off or not connected.	See Installing the water line.
	Water filter clogged.	Replace filter cartridge or remove filter and install plug.
	Air may be trapped in the water system.	Press the dispenser arm for at least two minutes.
	Dispenser is LOCKED.	Press and hold the Lock pad for 3 seconds.
Water spurting from dispenser	Newly-installed filter cartridge.	Run water from the dispenser for 3 minutes (about 172 gallons [5.7 liters]).



Water is not dispensed	Water in reservoir is frozen.	Call for service.
No water or ice cube production	Supply line or shutoff valve is clogged.	Call a plumber.
	Water filter clogged.	Replace filter cartridge or remove filter and install plug.
	Dispenser is LOCKED.	Press and hold the Lock pad for 3 seconds.



Before you call for service



Problem	Possible Causes	What To Do
Refrigerator has odor	Foods transmitting odor to refrigerator.	Foods with strong odors should be tightly wrapped.
		Keep an open box of baking soda in refrigerator; replace every three months
	Interior needs cleaning.	See Care and cleaning.
	Defrost water drainage system needs cleaning.	See Care and cleaning.
Moisture forms on outside of refrigerator	Not unusual during periods of high humidity.	Wipe surface dry.
Moisture collects inside	Too frequent or too long door openings.	
Interior light does not work	No power at outlet.	Replace fuse or reset the breaker.
	Light bulb burned out.	See Replacing the light bulbs.
Water on kitchen floor or on bottom of freezer	Drain in the bottom of the freezer clogged.	See Care and cleaning.
	Cubes jammed in chute.	Poke ice through with a wooden spoon.
Hot air from bottom of refrigerator	Normal air flow cooling motor. In the refrigeration process, it is normal that heat be expelled in the area under the refrigerator. Some floor coverings are sensitive	

	and will discolor at these normal and safe temperatures.	
Cubed Ice was selected but Crushed Ice was dispensed (on some models)	Last setting was Crushed Ice.	A few cubes were left in the crusher from the previous setting. This is normal.
Frequent “buzzing” sound	Icemaker power switch is in the	Slide the power switch to the OFF position. Keeping it in the ON position will damage the water valve.

Save time and money! Review the charts on the following pages first and you may not need to call for service.

Warning

This content is compiled from multiple sources and is provided for reference purposes only. It may not be complete or fully applicable to all situations. If you are unable to resolve your issue, please contact the product manufacturer or an authorized service provider for official support.

