

## INSTALLATION

### Installation Overview

Please read the following installation instructions first after purchasing this product or transporting it to another location.

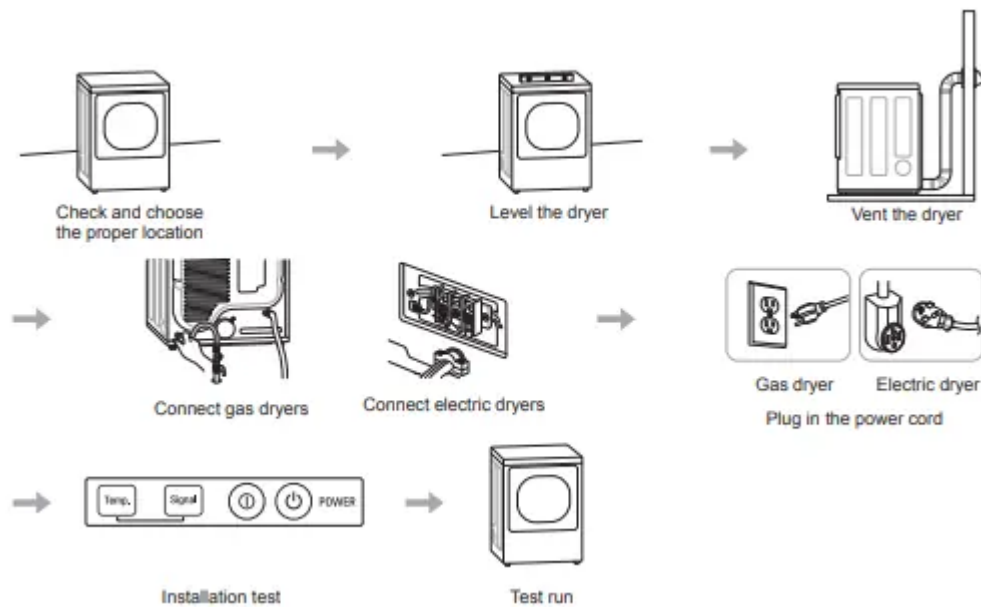

### Product Specifications

The appearance and specifications listed in this manual may vary due to constant product improvements.

Dryer Models	DLE7300*E, DLG7301*E
Electrical requirements	Please refer to the rating label regarding detailed information.
Gas requirements	NG: 4–10.5-inch WC LP: 8–13-inch WC
Dimensions	27" (W) X 29 1/2" (D) X 44 1/4" (H), 50 1/4" (D with door open) 68.6 cm (W) X 75.0 cm (D) X 112.3 cm (H), 127.5 cm (D with door open)
Net weight	Gas dryer : 124.6 lb (56.5 Kg) Electric dryer : 122.4 lb (55.5 Kg)
Drying capacity - Normal cycle	IEC 7.3 cu.ft. (22.5 lb/10.2 kg)

### Installation Location Requirements

#### Warning

Read all installation instructions completely before installing and operating the dryer! It is important that you review this entire manual before installing and using the dryer. Detailed instructions concerning electrical connections, gas connections, and exhaust requirements are provided on the following pages.

The installation requires:

- A location that allows for proper exhaust installation. A gas dryer must be exhausted to the outdoors. See Venting the Dryer.
- A grounded electrical outlet located within 2 ft. (61 cm) of either side of the dryer. See Connecting Electric Dryers .
- A sturdy floor to support the total dryer weight of 200 lb (90.7 kg). The combined weight of a companion appliance should also be considered.
- No other fuel-burning appliance can be installed in the same closet as a dryer.

Do not operate the dryer at temperatures below 45 °F (7 °C). At lower temperatures, the dryer might not shut off at the end of an automatic cycle. This can result in longer drying times. The dryer must not be installed or stored in an area where it will be exposed to water and/or weather. Check code requirements. Some codes limit, or do not permit, installation of the dryer in garages, closets, mobile homes or sleeping quarters. Contact your local building inspector.

#### NOTE

- The floor must be level, with a maximum slope of 1 inch (2.5 cm) under the entire dryer. Clothes may not tumble properly, and automatic sensor cycles may not operate correctly if dryer is not level.
- For a garage installation, you will need to place the dryer at least 18 inches (46 cm) above the floor. The standard pedestal is 15 inches (38.1 cm). You will need 18 inches (46 cm) from the garage floor to the bottom of the dryer.

#### Clearances

##### **Installation Spacing for Recessed Area or Closet Installation**

The following spacing dimensions are recommended for this dryer. This dryer has been tested for clearances of inch (2.5 cm) on the sides and rear. Recommended clearances should be considered for the following reasons:

- Additional clearances should be considered for ease of installation and servicing.
- Additional clearances might be required for wall, door and floor moldings.
- Additional clearances should be considered on all sides of the dryer to reduce noise transfer. For closet installation, with a door, minimum ventilation openings in the top and bottom of the door are required. Louvered doors with equivalent ventilation openings are acceptable.
- Companion appliance spacing should also be considered.

##### **Closet Ventilation Requirements**

Closets with doors must have both an upper and lower vent to prevent heat and moisture buildup in the closet.

One upper vent opening with a minimum opening of 48 sq. in. (310 cm<sup>2</sup>) must be installed no lower than 6 feet above the floor. One lower vent opening with a minimum opening of 24 sq. in. (155 cm<sup>2</sup>) must be installed no more than one foot above the floor. Install vent grills in the door or cut down the door at the top and bottom to form openings. Louvered doors with equivalent ventilation openings are also acceptable.

### Installation Spacing for Recessed Area or Closet

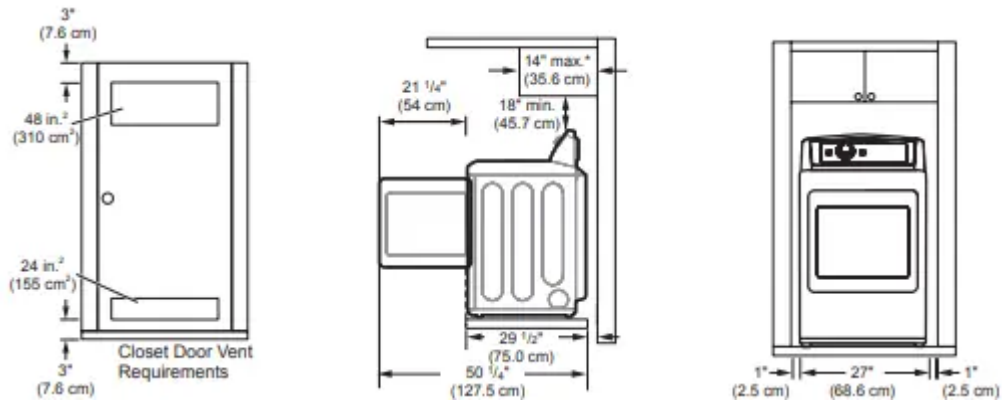

### Installation Spacing for Cabinet

For cabinet installation with a door, minimum ventilation openings in the top of the cabinet are required.

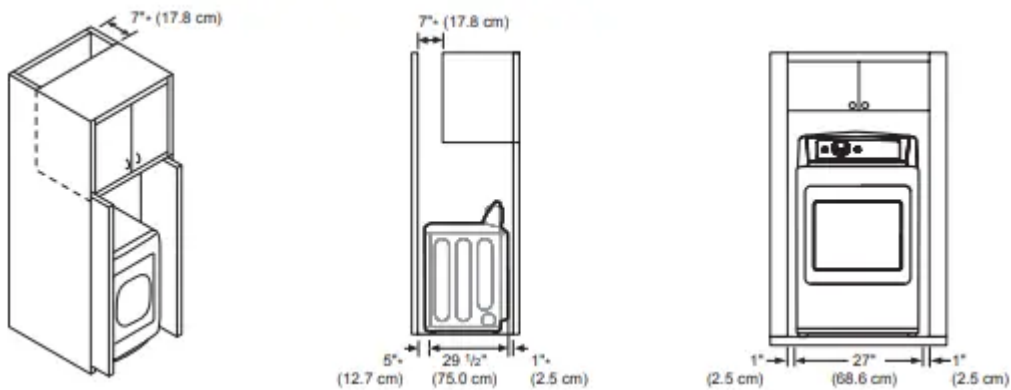

### Leveling the Dryer

1 Position the dryer in the final location. Check levelness of dryer from side to side. Repeat from front to back.



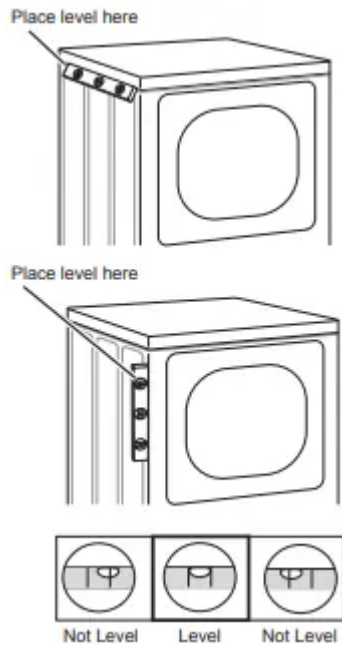

2 Use an adjustable wrench to turn the leveling feet. Unscrew the legs to raise the dryer or screw in the legs to lower it. Raise or lower with the leveling feet until the dryer is level from side to side and front to back. Make sure that all four leveling feet are in firm contact with the floor.

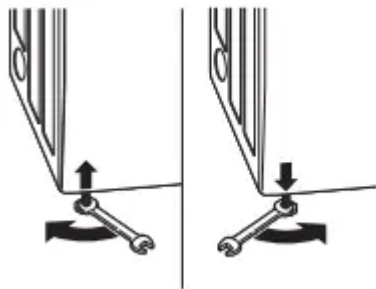

If you are installing the dryer on the optional pedestal, you must use the leveling feet on the pedestal to level the dryer. The dryer leveling feet should be fully retracted.

## Reversing the Door

### Tools Required

Phillips or large flat-blade screwdriver (for hinge screws) Small flat-blade screwdriver (for lifting out parts)

### Warning

The dryer door is very large and heavy.

Failure to follow the instructions below can result in damage to the dryer, property damage or personal injury.

- To avoid damage to the dryer or the door, support the door with a stool or box that fits under the door, or have an assistant support the weight of the door.

- Avoid dropping the door to prevent damage to the door or the floor.
- Unplug the dryer or turn off power at the main circuit breaker before beginning door reversal.

### Door Reversal Instructions

#### NOTE

The instructions here are for changing the door swing from a right to a left side hinge. If the door has been reversed, and it is necessary to change it back, use care when following these instructions.

Some of the illustrations and the left/right references will be reversed, and you will need to read the instructions carefully.

#### Swing door

1 Open the door from the side so that the hinge screws are accessible.

#### Warning

Be sure to support the weight of the door before removing the hinge screws.

2 Remove the four hinge screws.

While supporting the door, remove the four hinge screws, two from each hinge. Set the door aside face down on a protected surface to prevent damage to the door or the work surface.

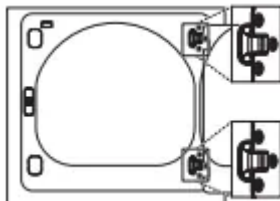

3 Reverse the components on the cabinet.

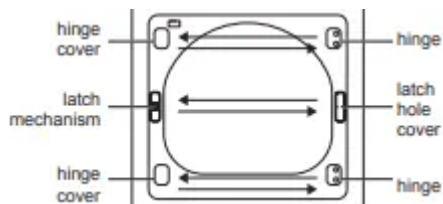

a. Use a Phillips screwdriver to remove the two screws and the latch mechanism on the front panel of the cabinet.

b. Remove the latch hole cover by gently prying it up with a flat blade screwdriver, being careful not to scratch the paint. Install the latch hole cover on the opposite side, where the latch mechanism was removed. Install the latch mechanism in the position from which you removed the latch hole cover, using the two screws removed in step a.

c. Remove the hinge cover by gently prying it up with a flat blade screwdriver, being careful not to scratch the paint. Rotate the hinge cover degrees and install it on the opposite side, where the hinge was attached.

4 With the door on a protected surface, remove all screws on the sides of the door and lift off the inner door frame using a flat blade screwdriver. Remove the latch hook and blank and install them on the opposite side.

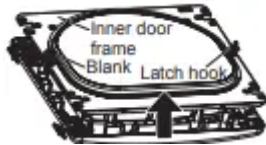

5 Remove the 4 screws securing the hinges to the door frame. Remove the two plastic cover caps. Reinstall the hinges and cover caps on the opposite sides from which they were removed.

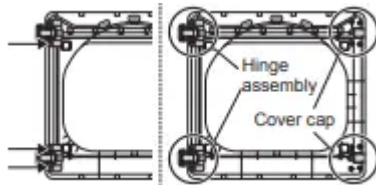

6 With the hinges and cover caps in the new locations, remount the inner door frame onto the outer door frame with the screws removed in step 4 above.

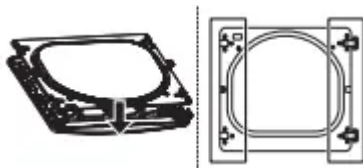

7 Reinstall the door.

While supporting the door, install the four hinge screws removed in step 2. Test the swing of the door to make sure the hinges and latch are properly aligned and that the door opens, closes and latches properly.

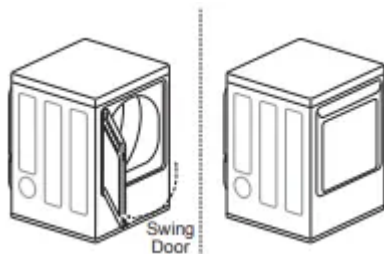

### Easy Load™ Door (on some models)

The door reversal procedure for the Easy Load door is far more complex than for a conventional swing door. Read through these instructions in their entirety before beginning the process, to judge whether you prefer to have the procedure done by a professional installer or service person.

The instructions here are for changing the door swing from a right to a left side hinge. If the door has been reversed, and it is necessary to change it back, use care when following these instructions. Some of the illustrations and the left/right references will be reversed, and you will need to read the instructions carefully.

### Tools Required

Phillips or large flat-blade screwdriver (for hinge screws) Small flat-blade screwdriver (for lifting out parts)

ON THE CABINET :

- 1 Open the door from the side so that the hinge screws are accessible.
- 2 Remove the door from cabinet.
  - a. While supporting the door, remove the four hinge screws.

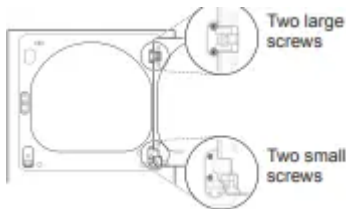

- b. Lift the door slightly to disengage the hinge support and remove the door from the cabinet. Set the door aside face down on a protected work surface.

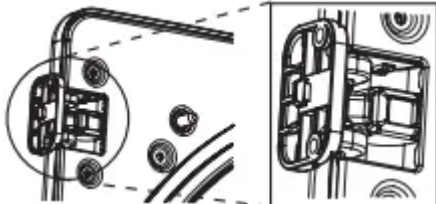

- 3 Reverse the components on the cabinet.

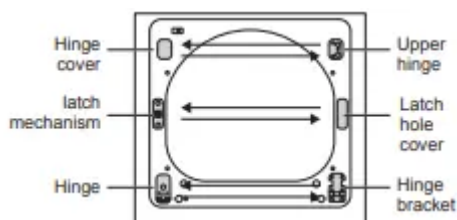

- a. Use a Phillips screwdriver to remove the two screws and the latch mechanism on the front panel of the cabinet.
  - b. Remove the latch hole cover by gently prying it up with a flat blade screwdriver, being careful not to scratch the paint. Install the latch hole cover on the opposite side, where the latch mechanism was removed. Install the latch mechanism in the position from which you removed the latch hole cover, using the two screws removed in step a.
  - c. Remove the hinge cover by gently prying it up with a flat blade screwdriver, being careful not to scratch the paint. Rotate the hinge cover degrees and install it on the

opposite side, where the upper hinge was attached. d.Reverse the hinge and the hinge bracket at the bottom of the cabinet. Remove the two screws from the hinge bracket at the bottom right and remove the hinge bracket. Remove the lower of the two screws behind the hinge bracket. Do NOT remove the upper screw behind the hinge bracket. Set the parts aside.

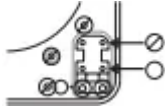

CAUTION: Do NOT remove any of the eight screws on the face of the cabinet (marked below). Doing so could result in damage to the dryer and the need for a service call to repair the dryer.

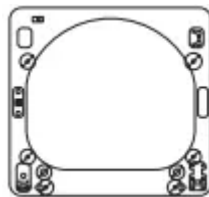

e.Remove the three screws on the hinge at the bottom left. Remove the hinge and reinstall it on the right side. The top screw will occupy the hole where you removed the screw behind the hinge bracket in step d.



f. Install the hinge bracket removed in step d on the bottom left side, first installing one screw behind the hinge bracket. hinge cover hinge bracket latch hole cover latch mechanism hinge

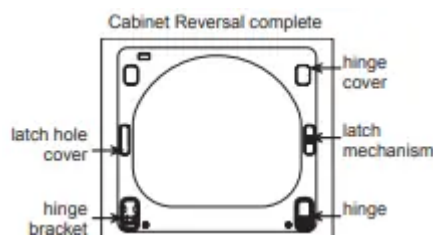

ON THE DOOR:

4 Lift off the door cover.

With the door laid inside facing up on a protected surface, remove the twelve screws on the inside of the door. (The two bottom screws will be different from the rest.) Carefully lift off the door cover with the help of a small flat blade screwdriver inserted in the upper left corner.

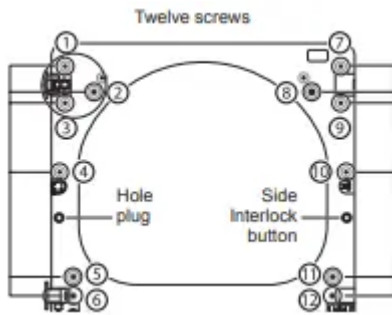

#### 5 Switch the door strike and the blank cover.

Remove the two screws on the door cover that secure the door strike.

Switch the door strike and the blank cover, installing them on the opposite sides from which they were removed.

It may be difficult to insert the two screws in the door strike on the opposite side. Use a cordless screwdriver if necessary.

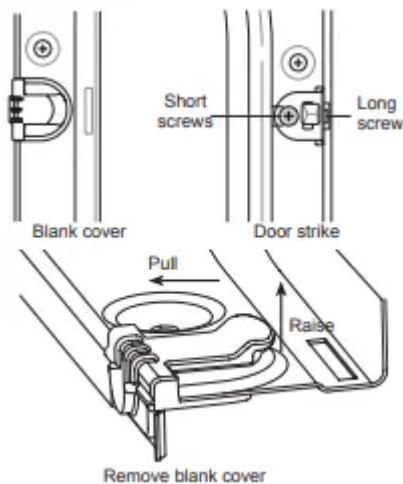

Gently pry out the hole plug on the side of the door cover and install it in the hole on the opposite side.

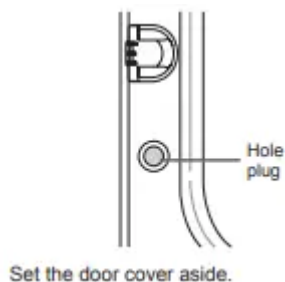

#### 6 Reverse the components inside the door.

You will now be removing and reversing various components inside the door. See below for a detailed diagram and identification of the inner structure and parts of the door. (The diagram shows the “before view” of the door, with the default set-up for a right side hinge swing. After following these instructions, the door should be a mirror image of the illustration.)

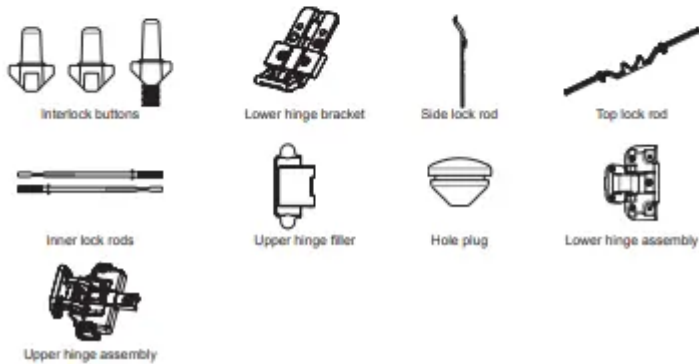
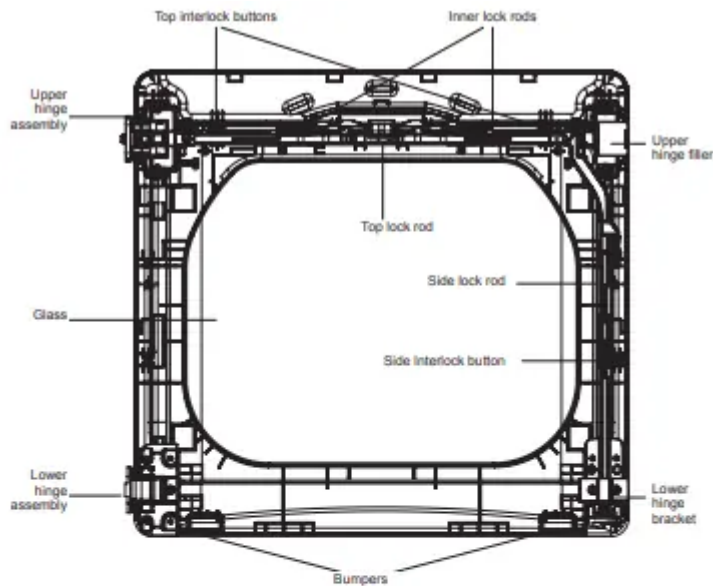

7 Lift out the gray interlock button in the side of the door.

Make sure to remove the spring with the interlock button and to keep the two together. Set the interlock button aside. Do not confuse this with the interlock buttons from the top of the outer door.

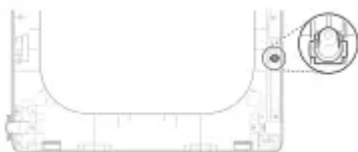

8 Remove the side lock rod.

Remove the side lock rod from the lower hinge bracket by lifting the top end of the rod and sliding it toward the top of the door. The spring should remain attached to the lock rod. Set the lock rod aside.

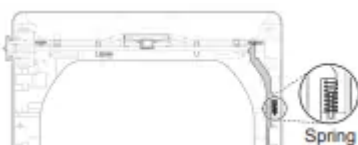

9 Reverse the upper hinge assembly and hinge filler.



a. Remove the screw connecting the upper hinge assembly to the top lock rod and set it aside.

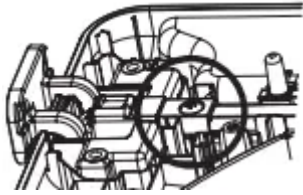

b. Lift out the upper hinge filler (on the right) and set it aside.

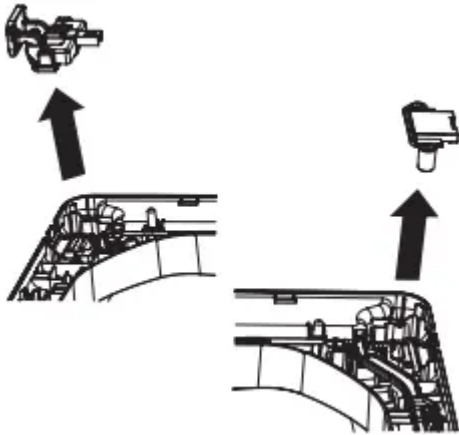

c. Lift out the upper hinge assembly (on the left).

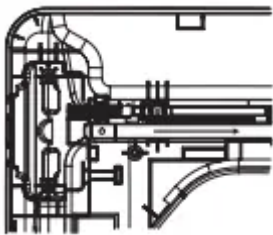

d. Slide the upper lock rod to the right. Rotate the upper hinge assembly 180 degrees, and install it over the lock rod on the right, where you removed the upper hinge filler. Press firmly to fully seat the hinge assembly.

e. Rotate the hinge filler 180 degrees and install it on the upper left side of the door.

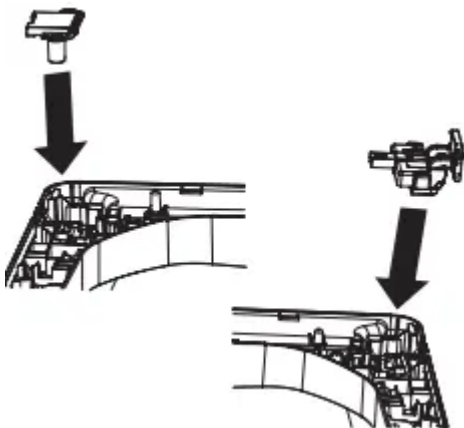

f. Insert and tighten the screw connecting the upper hinge assembly to the top lock rod, removed in step a.

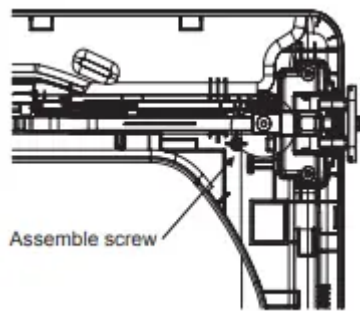

10 Reverse the lower hinge bracket and hinge assembly.

a. Remove one screw from the lower hinge bracket (on the right) and lift it out. Remove two screws from the lower hinge assembly (on the left) and lift it out.

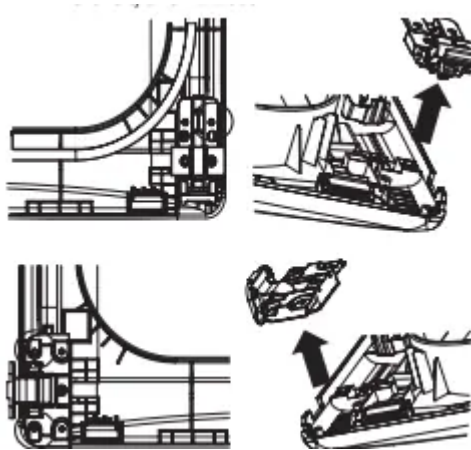

b. Rotate the lower hinge assembly 180 degrees and install it on the right side using the two screws removed in step a.

c. Mount the lower hinge bracket on the lower left with the screw removed in step a.

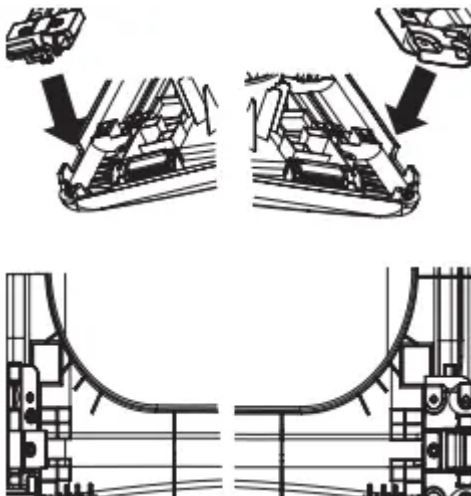

11 Install the side lock rod.

a. Flip the side lock rod over and insert the lower end into the left hinge bracket.

b. Lower the rod into the guides on the door while compressing the spring inside the recess.

NOTE: Make sure the top of the side lock rod is beside the top lock rod and the two do not overlap each other. If they are not aligned properly, the door will not operate properly.

NOTE: Make sure the spring stays on the side lock rod.

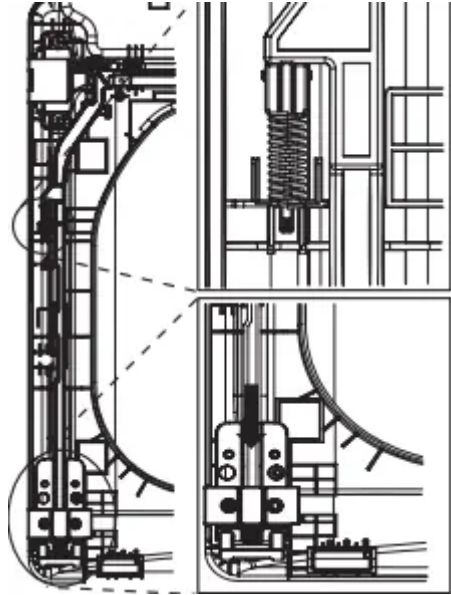

12 Reinstall the side interlock button.

Install the side interlock button on the opposite side from which it was removed.

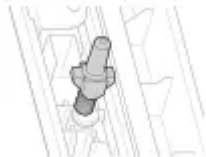

13 Reinstall the door cover.

a. Clean the glass on the door and door cover, if necessary.

b. Make sure the three gray interlock buttons are properly installed and that the top and side lock rods intersect properly.

c. Carefully lower the door cover into place, aligning the holes in the cover with the three interlock buttons and the bumpers on the bottom edge. You may need to force fit the door cover.

d. Once the door cover is in place, secure it with the 12 screws removed in step 4.

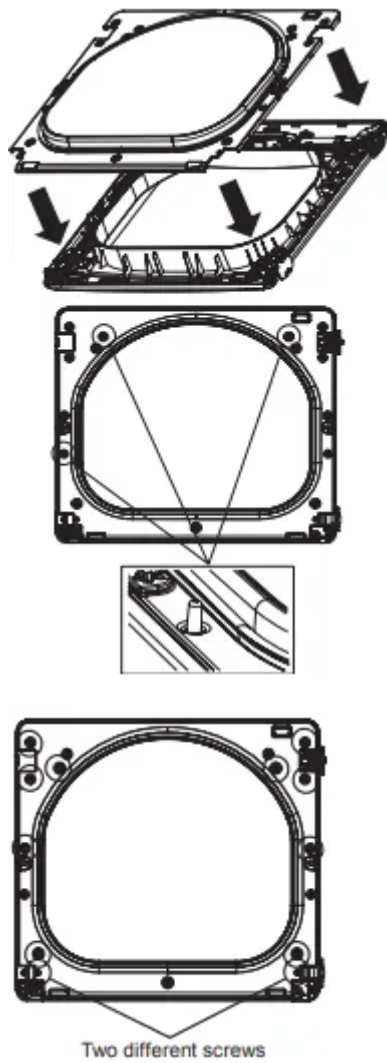

14 Reassemble the door on cabinet.

While supporting the door, insert the hinge support into the slot in the door and slide the door down slightly to seat it. Install the four hinge screws removed in step 2. Test the swing of the door to check the alignment of the hinges and latch. Make sure the door opens, closes, and latches properly in both directions.

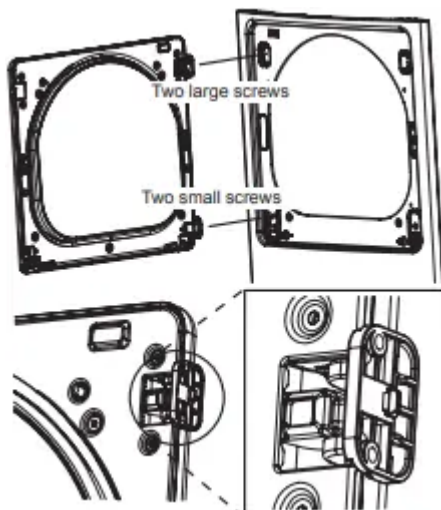

## Installing the Side Vent Kit

### Warning

- Use a heavy metal vent.
- Do not use plastic or thin foil ducts.
- Clean old ducts before installing this dryer.
- To reduce the risk of injury to persons, adhere to all industry recommended safety procedures including the use of long-sleeved gloves and safety glasses.
- Failure to follow all of the safety warnings in this manual could result in property damage, injury to persons, or death.

The dryer is shipped to vent to the rear. It can also be configured to vent to the bottom or side (right-side venting is not available on gas models).

An adapter kit, part number 383EEL9001B, may be purchased from an LG retailer. This kit contains the necessary duct components to change the dryer vent location.

1 Remove the rear exhaust duct retaining screw.

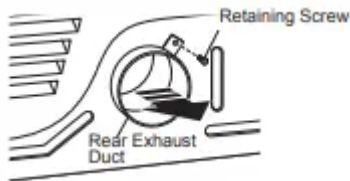

### Option 1: Side Venting

2 Press the tabs on the knockout and carefully remove the knockout for the desired vent opening (right-side venting is not available on gas models). Press the adapter duct onto the blower housing and secure to the base of the dryer as shown.

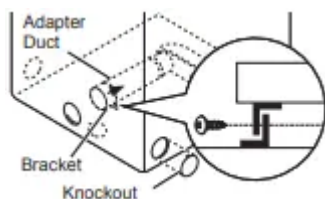

3 Preassemble a 4-inch (10.2 cm) elbow to the next 4-inch (10.2 cm) duct section, and secure all joints with duct tape. Be sure that the male end of the elbow faces AWAY from the dryer. Insert the elbow/duct assembly through the side opening and press it onto the adapter duct. Secure it in place with duct tape. Be sure that the male end of the duct protrudes 1½ inches (cm) to connect the remaining ductwork. Attach the cover plate to the back of the dryer with the included screw.

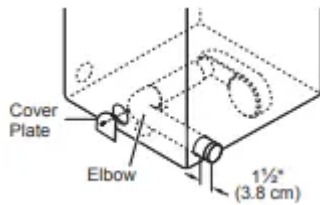

### Option 2: Bottom Venting

2 Press the adapter duct onto the blower housing and secure it to the base of the dryer as shown.

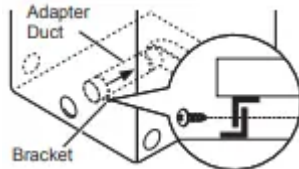

3 Insert the 4-inch (10.2 cm) elbow through the rear opening and press it onto the adapter duct. Be sure that the male end of the elbow faces down through the hole in the bottom of the dryer. Secure it in place with duct tape. Attach the cover plate to the back of the dryer with the included screw.

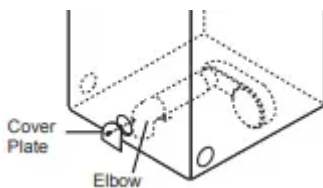



### Venting the Dryer

Warning: To reduce the risk of fire or explosion, electric shock, property damage, injury to persons or death when using this appliance, follow basic safety precautions, including the following:

- Do not crush or collapse ductwork. Failure to follow these instructions may result in fire or death.
- Do not allow ductwork to rest on or contact sharp objects. Failure to follow these instructions may result in fire or death.
- If connecting to existing ductwork, make sure it is suitable and clean before installing the dryer. Failure to follow these instructions may result in fire or death.
- Venting must conform to local building codes.
- Failure to follow these instructions may result in fire or death.
- Gas dryers MUST exhaust to the outdoors.
- Failure to follow these instructions may result in fire or death.

- Use only 4-inch (10.2 cm) rigid, semi-rigid or flexible metal ductwork inside the dryer cabinet and for venting outside. Failure to follow these instructions may result in fire or death.
- To reduce the risk of fire, combustion, or accumulation of combustible gases, DO
- NOT exhaust dryer air into an enclosed and unventilated area, such as an attic, wall, ceiling, crawl space, chimney, gas vent, or concealed space of a building. Failure to follow these instructions may result in fire or death.
- To reduce the risk of fire, DO NOT exhaust the dryer with plastic or thin foil ducting. Failure to follow these instructions may result in fire or death.
- The exhaust duct must be 4 inches (10.2 cm) in diameter with no obstructions. The exhaust duct should be kept as short as possible. Make sure to clean any old ducts before installing your new dryer. Failure to follow these instructions may result in fire or death.
- Rigid, semi-rigid or flexible metal ducting is recommended for use between the dryer and the wall. All non-rigid metal transition duct must be UL-listed. Use of other materials for transition duct could affect drying time. Failure to follow these instructions may result in fire or death.
- DO NOT use sheet metal screws or other fasteners which extend into the duct that could catch lint and reduce the efficiency of the exhaust system. Secure all joints with duct tape. Failure to follow these instructions may result in fire or death.
- Do not exceed the recommended duct length limitations noted in the chart. Failure to follow these instructions may result in extended drying times, fire or death.
- Ductwork is not provided with the dryer. You should obtain the necessary ductwork locally.
- The vent hood should have hinged dampers to prevent backdraft when the dryer is not in use. Failure to follow these instructions may result in fire or death.
- The total length of flexible metal duct must not exceed 8 ft. (2.4 m).
- In Canada, only those foil-type flexible ducts, if any, specifically identified for use with the appliance by the manufacturer should be used.
- In the United States, only those foil-type flexible ducts, if any, specifically identified for use with the appliance by the manufacturer and that comply with the Outline for Clothes Dryer Transition Duct, Subject 2158A, should be used.

## **Ductwork**

Wall Cap Type	Number of 90° Elbows	Maximum length of 4-inch (10.2 cm) diameter rigid metal duct
Recommended  4" (10.2 cm)  4" (10.2 cm)	0	65 ft. (19.8 m)
	1	55 ft. (16.8 m)
	2	47 ft. (14.3 m)
	3	36 ft. (11.0 m)
	4	28 ft. (8.5 m)
Use only for short run installations  2 1/2" (6.35 cm)	0	55 ft. (16.8 m)
	1	47 ft. (14.3 m)
	2	41 ft. (12.5 m)
	3	30 ft. (9.1 m)
	4	22 ft. (6.7 m)

## Routing And Connecting Ductwork

NOTE: Follow the guidelines below to maximize drying performance and reduce lint buildup and condensation in the ductwork. Ductwork and fittings are NOT included and must be purchased separately.

- Use 4-inch (10.2 cm) diameter rigid, semi-rigid or flexible metal ductwork.
- The exhaust duct run should be as short as possible.
- Use as few elbow joints as possible.
- The male end of each section of exhaust duct must point away from the dryer.
- Use duct tape on all duct joints.
- Insulate ductwork that runs through unheated areas in order to reduce condensation and lint buildup on duct surfaces.
- Incorrect or inadequate exhaust systems are not covered by the dryer warranty. Dryer failures or service required because of such exhaust systems will not be covered by the dryer warranty.

## Correct Venting

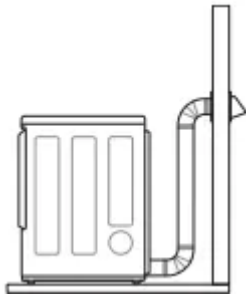

## Incorrect Venting

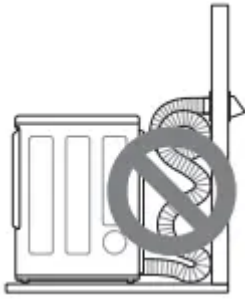

## Connecting Gas Dryers

Warning: To reduce the risk of fire or explosion, electric shock, property damage, injury to persons, or death when using this appliance, follow basic safety precautions.

### Gas Supply Requirements

- As shipped from the factory, this dryer is configured for use with natural gas (NG). It can be converted for use with propane (LP) gas. Gas pressure must not exceed 8 inches cm) of water column for NG, or 13 inches cm) of water column for LP.
- A qualified service or gas company technician must connect the dryer to the gas service. Failure to follow these instructions may result in fire, explosion, or death.
- Isolate the dryer from the gas supply system by closing its individual manual shutoff valve during any pressure testing of the gas supply. Failure to do so may result in fire, explosion, or death.
- Supply line requirements: Your laundry room must have a rigid gas supply line to the dryer. In the United States, an individual manual shutoff valve **MUST** be installed within at least 6 ft. (1.8 m) of the dryer, in accordance with the National Fuel Gas Code ANSI Z223.1 or Canadian gas installation code CSA B149.1. A 1/8-inch (0.3 cm) NPT pipe plug must be installed. Failure to do so may result in fire, explosion, or death.
- If using a rigid pipe, the rigid pipe should be 1/4 inch IPS. If acceptable under local codes and ordinances and when acceptable to your gas supplier, 3/8-inch (1 cm) approved tubing may be used where lengths are less than 20 ft. m). Larger tubing should be used for lengths in excess of 20 ft. (6.1 m). Failure to do so may result in fire, explosion, or death.
- Connect the dryer to the type of gas shown on the nameplate. Failure to do so may result in fire, explosion, or death.
- To prevent contamination of the gas valve, purge the gas supply of air and sediment before connecting the gas supply to the dryer. Before tightening the connection between the gas supply and the dryer, purge remaining air until the odor of gas is detected. Failure to do so may result in fire, explosion, or death.
- **DO NOT** use an open flame to inspect for gas leaks. Use a noncorrosive leak detection fluid. Failure to do so may result in fire, explosion, or death.

- Use only a new AGA- or CSA-certified gas supply line with flexible stainless steel connectors. Failure to do so may result in fire, explosion, or death.
- Securely tighten all gas connections. Failure to do so may result in fire, explosion, or death.
- Use Teflon tape or a pipe-joint compound that is insoluble in propane (LP) gas on all pipe threads. Failure to do so may result in fire, explosion, or death.
- DO NOT attempt any disassembly of the dryer; disassembly requires the attention and tools of an authorized and qualified service technician or company. Failure to follow this warning may result in fire, explosion, or death.

### **Electrical Requirements for Gas Models Only**

- Do not, under any circumstances, cut or remove the third (ground) prong from the power cord. Failure to follow this warning may result in fire, explosion, or death.
- For personal safety, this dryer must be properly grounded. Failure to follow this warning may result in fire, explosion, or death.
- This dryer must be plugged into a 120-VAC, 60 Hz. grounded outlet protected by a ampere fuse or circuit breaker. Failure to follow this warning may result in fire, explosion, or death.
- Where a standard 2-prong wall outlet is encountered, it is your personal responsibility and obligation to have it replaced with a properly grounded 3-prong wall outlet. Failure to follow this warning may result in fire, explosion, or death.

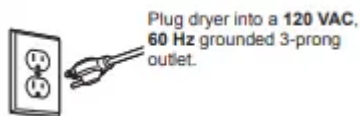

### **Connecting the Gas Supply**

- Installation and service must be performed by a qualified installer, service agency, or the gas supplier. Failure to do so may result in fire, explosion, or death.
- Use only a new stainless steel flexible connector and a new AGA-certified connector. Failure to do so may result in fire, explosion, or death.
- A gas shutoff valve must be installed within 6 ft.(1.8 m) of the dryer. Failure to do so may result in fire, explosion, or death.
- The dryer is configured for natural gas when shipped from the factory. Make sure that the dryer is equipped with the correct burner nozzle for the type of gas being used (natural gas or propane gas). Failure to do so may result in fire, explosion, or death.
- If necessary, the correct nozzle (for the LP nozzle kit, order part number 383EEL3002D) should be installed by a qualified technician and the change should be noted on the dryer. Failure to do so may result in fire, explosion, or death.

- All connections must be in accordance with local codes and regulations. Failure to do so may result in fire, explosion, or death.
- Gas dryers MUST exhaust to the outdoors. Failure to do so may result in fire, explosion, or death.

NOTE: This dryer is configured from the factory for natural gas (NG). If the dryer is to be used with propane (LP) gas, it must be converted by a qualified service technician.

- 1 Make sure that the gas supply to the laundry room is turned OFF and the dryer is unplugged. Confirm that the type of gas available in your laundry room is appropriate for the dryer.
- 2 Remove the shipping cap from the gas fitting at the back of the dryer. Be careful not to damage the threads of the gas connector when removing the shipping cap.
- 3 Connect the dryer to your laundry room's gas supply using a new flexible stainless steel connector with a 3/8-inch NPT fitting. NOTE: DO NOT use old connectors.
- 4 Securely tighten all connections between the dryer and your laundry room's gas supply.
- 5 Turn on your laundry room's gas supply.
- 6 Check all pipe connections (both internal and external) for gas leaks with a noncorrosive leak-detection fluid.
- 7 Proceed to Venting the Dryer.

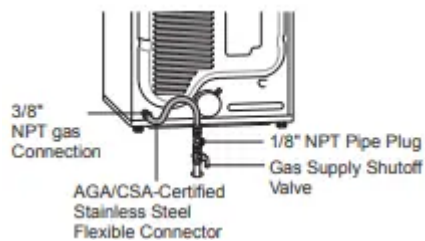

### High-Altitude Installations

The BTU rating of this dryer is AGA-certified for elevations below 10,000 feet.

If your gas dryer is being installed at an elevation above 10,000 feet, it must be derated by a qualified technician or gas supplier.

### Connecting Electric Dryers

#### Electrical Requirements for Electric Models Only

Warning: To help prevent fire, electric shock, serious injury, or death, the wiring and grounding must conform to the latest edition of the National Electrical Code, ANSI/NFPA 70 and all applicable local regulations. Please contact a qualified electrician to

check your home's wiring and fuses to ensure that your home has adequate electrical power to operate the dryer.

- This dryer must be connected to a grounded metal, permanent wiring system, or an equipment-grounding conductor must be run with the circuit conductors and connected to the equipment-grounding terminal or lead on the dryer. Failure to do so may result in fire, explosion, or death.
- The dryer has its own terminal block that must be connected to a separate 240 VAC, 60-Hertz, single-phase circuit, fused at 30 amperes (the circuit must be fused on both sides of the line). ELECTRICAL SERVICE FOR THE DRYER SHOULD BE OF THE MAXIMUM RATE VOLTAGE LISTED ON THE NAMEPLATE. DO NOT CONNECT THE DRYER TO 110-, 115-, OR 120- VOLT CIRCUIT. Failure to follow these instructions may result in fire, explosion, or death.
- If the branch circuit to dryer is 15 ft. (4.5 m) or less in length, use UL (Underwriters Laboratories) listed No. 10 AWG wire (copper wire only), or as required by local codes. If over 15 ft. (4.5 m), use UL-listed No. 8 AWG wire (copper wire only), or as required by local codes. Allow sufficient slack in wiring so the dryer can be moved from its normal location when necessary. Failure to do so may result in fire, explosion, or death.
- The power cord (pigtail) connection between the wall receptacle and the dryer terminal block IS NOT supplied with the dryer. Type of pigtail and gauge of wire must conform to local codes and with instructions on the following pages. Failure to follow these instructions may result in fire, explosion, or death.
- A 4-wire connection is required for all mobile and manufactured home installations, as well as all new construction after January 1, 1996. A 4-wire connection must be used where local codes do not permit grounding through the neutral wire. Failure to do so may result in fire, explosion, or death.
- Do not modify the plug and internal wire provided with the dryer.
- The dryer should be connected to a 4-hole outlet.
- If the plug does not fit the outlet, a proper outlet will need to be installed by a qualified electrician.

### **Special Electrical Requirements for Mobile or Manufactured Homes**

- Any installation in a manufactured or mobile home must comply with the Manufactured Home Construction and Safety Standards Title 24 CFR, Part 3280 or Standard CAN/CSA Z240 MH and local codes and ordinances. If you are uncertain whether your proposed installation will comply with these standards, please contact a service and installation professional for assistance.
- A 4-wire connection is required for all mobile and manufactured home installations, as well as all new construction after January 1, 1996. Failure to do so may result in fire, explosion, or death.

- A gas dryer must be permanently attached to the floor.
- The electrical connection for an electric dryer must be a 4-wire connection. More detailed information concerning the electrical connection is provided in the Connecting Electric Dryers section.
- To reduce the risk of combustion and fire, the dryer must be vented to the outside.
- DO NOT vent the dryer under a manufactured home or mobile home.
- Electric dryers may be vented to the outside using the back, left, right, or bottom panel.
- Gas dryers may be vented to the outside using the back, left, or bottom panel. Gas dryers may not be vented to the outside using the right side panel because of the burner housing.
- The dryer exhaust duct must be affixed securely to the manufactured or mobile home structure, and the exhaust duct must be made of a material that will resist fire and combustion. It is recommended that you use a rigid, semi-rigid or flexible metal duct.
- DO NOT connect the dryer exhaust duct to any other duct, vent, chimney, or other exhaust duct.
- Make sure the dryer has adequate access to outside fresh air to ensure proper operation. The opening for outside fresh air must be at least 25 sq. in (163 cm<sup>2</sup>)
- It is important that the clearance of the duct from any combustible construction be at least 2 inches (5cm), and when venting the dryer to the outdoors, the dryer should be installed with a clearance of at least 1 inch (2.5 cm) at the sides and back of the dryer.
- Venting materials are not supplied with the dryer. You must obtain the venting materials necessary for proper installation.

#### Warning

Connect the power cord to the terminal block.

Connect each wire in the power cord to the terminal block screw with the matching colored wire. The terminal block wire colors are indicated in the manual. Failure to follow these instructions may result in a short or overload.

Grounding through the neutral conductor is prohibited for: (1) new branch-circuit installations, (2) mobile homes, (3) recreational vehicles, and areas where local codes prohibit grounding through the neutral conductor.

#### **Four-Wire Power Cord**

- A 4-wire connection is required for all mobile and manufactured home installations, as well as all new construction after January 1, 1996.



- A UL-listed strain relief is required.
- Use a 30-amp, 240-volt, 4-wire, UL-listed power cord with #10 AWG-minimum copper conductor and closed loop or forked terminals with upturned ends.

1 Remove the terminal block access cover on the upper back of the dryer.

2 Install a UL-listed strain relief into the power cord through-hole.

3 Thread a 30-amp, 240-volt, 4-wire, UL-listed power cord with #10 AWG-minimum copper conductor through the strain relief.

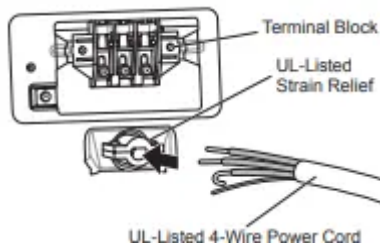

4 Transfer the dryer's ground wire from behind the green ground screw to the center screw of the terminal block.

5 Attach the two hot leads of the power cord to the outer terminal block screws.

6 Attach the white neutral wire to the center screw of the terminal block.

7 Attach the power cord ground wire to the green ground screw.

8 Tighten all screws securely.

9 Reinstall the terminal block access cover.

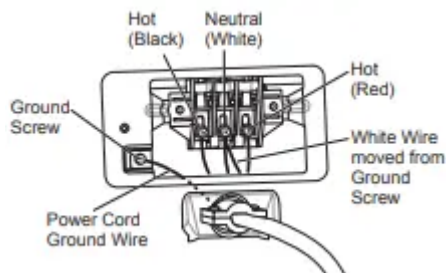

### Four-Wire Direct Wire

- A 4-wire connection is required for all mobile and manufactured home installations, as well as all new construction after January 1, 1996.



- A UL-listed strain relief is required.

- Use UL-listed 4-wire #10 AWG-minimum copper conductor cable. Allow at least 5 ft. (1.5 m) of wire to allow for removal and reinstallation of the dryer.

1 Remove 5 inches (12.7 cm) of the outer covering from the wire. Remove 5 inches (12.7 cm) of insulation from the ground wire. Cut off approximately 1½ inches (3.8 cm) from the other three wires and strip 1 inch (2.5 cm) of insulation from each wire. Bend the ends of the three shorter wires into a hook shape.

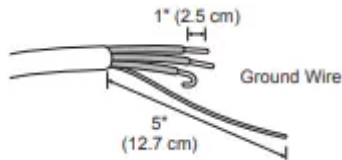

2 Remove the terminal block access cover on the upper back of the dryer.

3 Install a UL-listed strain relief into the power cord through-hole.

4 Thread the 4-wire #10 AWG-minimum copper power cable prepared in step 1 through the strain relief.

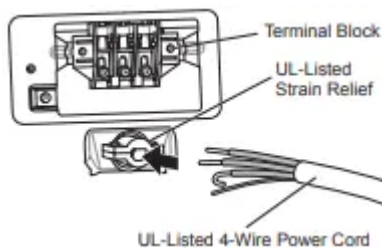

5 Transfer the dryer's ground wire from behind the green ground screw to the center screw of the terminal block.

6 Attach the two hot leads of the power cord to the outer terminal block screws.

7 Attach the white neutral wire to the center screw of the terminal block.

8 Attach the power cord ground wire to the green ground screw.

9 Tighten all screws securely.

10 Reinstall the terminal block access cover.

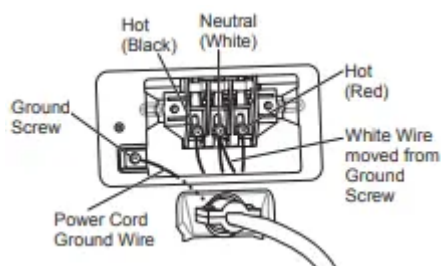

### Three-Wire Power Cord

- A 3-wire connection is NOT permitted on new construction after January 1996



- A UL-listed strain relief is required.
- Use a 30-amp, 240-volt, 3-wire, UL-listed power cord with #10 AWG-minimum copper conductor and closed loop or forked terminals with upturned ends.
  - 1 Remove the terminal block access cover on the upper back of the dryer.
  - 2 Install a UL-listed strain relief into the power cord through-hole.
  - 3 Thread a 30-amp, 240-volt, 3-wire, UL-listed power cord with #10 AWG-minimum copper conductor through the strain relief.

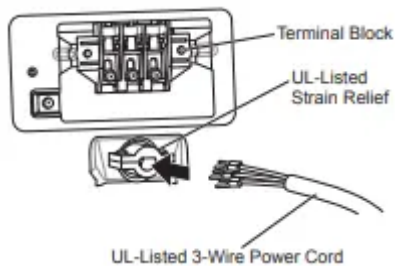

- 4 Attach the two hot leads (black and red) of the power cord to the outer terminal block screws.
- 5 Attach the neutral (white) wire to the center terminal block screw.

#### NOTE

The dryer is supplied with the neutral conductor grounded. If a 3-wire cord is to be used and is allowed, make sure the white neutral grounding wire is connected to the green ground screw.

- 6 Connect the external ground (if required by local codes) to the green ground screw.
- 7 Tighten all screws securely.
- 8 Reinstall the terminal block access cover.

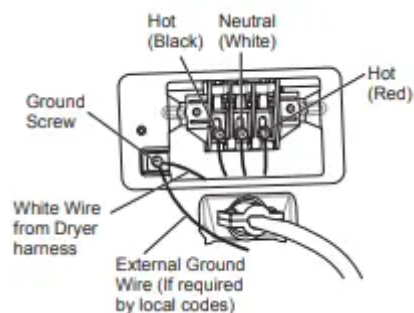

#### Three-Wire Direct Wire

- A 3-wire connection is NOT permitted on new construction after January 1,1996



- A UL-listed strain relief is required.
- Use UL-listed 3-wire, #10 AWG-minimum copper conductor cable. Allow at least 5 ft. (1.5 m) length to allow for removal and installation of dryer.

1 Remove 3½-inch (8.9 cm) of the outer covering from the wire. Strip 1 inch (2.5 cm) insulation from each wire. Bend the ends of the three wires into a hook shape. cm)



2 Remove the terminal block access cover on the upper back of the dryer.

3 Install a UL-listed strain relief into the power cord through-hole.

4 Thread the 3-wire, #10 AWG-minimum copper conductor power cable prepared in step 1 through the strain relief.

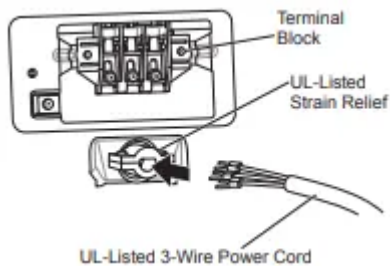

5 Attach the two hot leads (black and red) of the power cord to the outer terminal block screws.

6 Attach the neutral (white) wire to the center terminal block screw.

7 Connect the external ground (if required by local codes) to the green ground screw.

8 Tighten all screws securely.

9 Reinstall the terminal block access cover.

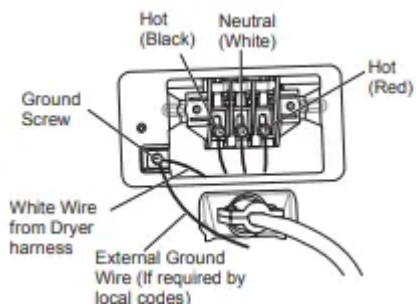

## Final Installation Check

Once you have completed the installation of the dryer and it is in its final location, confirm proper operation with the following tests and the Installation Test (Duct Check) on the following page.

### **Testing Dryer Heating**

#### **GAS MODELS**

Close the dryer door, press the POWER button to turn the dryer on, and start the dryer on a heat setting.

When the dryer starts, the igniter should ignite the main burner.

#### **ELECTRIC MODELS**

Close the dryer door, press the POWER button to turn the dryer on, and start the dryer on a heat setting.

The exhaust air should be warm after the dryer has been operating for 3 minutes.

### **Checking Airflow**

Effective dryer operation requires proper airflow. The adequacy of the airflow can be measured by evaluating the static pressure. Static pressure in the exhaust duct can be measured with a manometer, placed on the exhaust duct approximately 2 ft. (60.9 cm) from the dryer. Static pressure in the exhaust duct should not exceed 0.6-inch (1.5 cm). The dryer should be checked while the dryer is running with no load.

### **Checking Levelness**

Once the dryer is in its final location, recheck the dryer to be sure it is level. Make sure it is level front to back and side to side, and that all four leveling feet are firmly on the floor.

### **Checking Venting**

Vent ductwork should be checked for lint buildup and cleaned at least once per year. If any noticeable reduction in drying performance occurs, check duct for obstructions and blockages.

### **Installation Test (Duct Check)**

Once you have completed the installation of the dryer, use this test to make sure the condition of the exhaust system is adequate for proper operation of the dryer. This test should be performed to alert you to any serious problems in the exhaust system of your home.

- This dryer features Flow Sense™, an innovative sensing system that automatically detects blockages and restrictions in dryer ductwork. Keeping ductwork clean of lint buildup and free of restrictions allows clothes to dry faster and reduces energy use.

#### **NOTE**

The dryer should be cool before starting this test. If the dryer was warmed up during installation, run the AIR DRY cycle for a few minutes to reduce the interior temperature.

To activate the installation test:

1 Remove the drying rack and literature, and then close the door.

Do not load anything in the drum for this test, as in may affect the accuracy of the results.

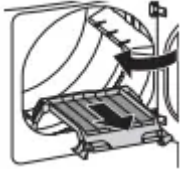

2 Press and hold the POWER, Temp., and Signal buttons until **1n5** and a usage count alternate in the display. (The usage count indicates the number of cycles run with no load during the last cycles.)

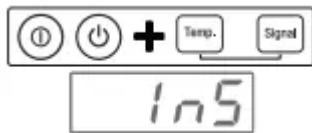

3 Press the START/PAUSE button.

The dryer will start the test, which will last about minutes. The heat will be turned on and the temperatures in the drum will be measured and displayed. A chime sounds when the test portion of the cycle is complete.



4 Check the display for results.

During the test cycle, monitor the Flow Sense™ display on the control panel. If no bars are displayed, when the cycle ends, the exhaust system is adequate. If the exhaust system is severely restricted, the display will show four bars. Other problems may also be shown with error codes. See the chart below for error code details and solutions.



Four bars indicates that the exhaust system is severely restricted. Have the system checked immediately, as performance will be poor.

5 End of cycle.

At the end of the test cycle, **End** will display. The test cycle will end and the dryer will shut off automatically after a short delay.

End

- Check the error code before you call for service

Error Code	Possible Causes	Solutions
tE1 or tE2	<ul style="list-style-type: none"><li>• Temperature sensor failure.</li></ul>	<ul style="list-style-type: none"><li>• Turn off the dryer and call for service.</li></ul>
HS	<ul style="list-style-type: none"><li>• Humidity sensor failure.</li></ul>	<ul style="list-style-type: none"><li>• Turn off the dryer and call for service.</li></ul>
PS or PF or nP	<ul style="list-style-type: none"><li>• Electric dryer power cord is not connected correctly, or house power supply is incorrect.</li><li>• House fuse is blown, circuit breaker has tripped, or power outage has occurred.</li></ul>	<ul style="list-style-type: none"><li>• Check the power supply or the connection of the power cord to the terminal block. Refer to the <b>Connecting Electric Dryers</b> section of this manual for complete instructions.</li><li>• Reset circuit breaker or replace fuse. Do not increase the fuse capacity. If the problem is a circuit overload, have it corrected by a qualified electrician.</li></ul>
gAS	<ul style="list-style-type: none"><li>• Gas supply or service turned off. (Gas Model only.)</li></ul>	<ul style="list-style-type: none"><li>• Confirm that house gas shutoff and the dryer gas shutoff are both fully open.</li></ul>

- Check the duct condition

If the Flow Sense™ LED is turned on, check the exhaust system for restrictions and damage. Repair or replace the exhaust system as needed.

#### NOTE

When the dryer is first installed, this test should be performed to alert you to any existing problems with the exhaust duct in your home.

However, since the test performed during normal operation provides more accurate information on the condition of the exhaust duct than does the installation test, the number of bars displayed during the two tests may not be the same.

Do not interrupt the test cycle, as this could result in inaccurate results.

Even if no bars are displayed during the test cycle, some restrictions may still be present in the exhaust system. Refer to the Venting the Dryer section of this manual for complete exhaust system and venting requirements.

#### Restricted or Blocked Airflow

Avoid long runs or runs with multiple elbows or bends.

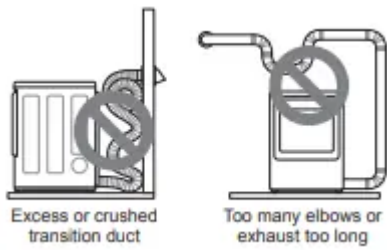

Check for blockages and lint buildup.

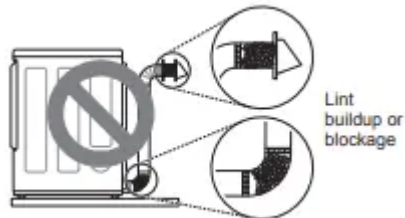

Make sure the ductwork is not crushed or restricted.

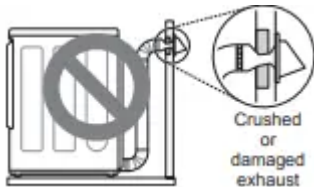

## OPERATION

### Using the Dryer

#### 1 Clean the Lint Filter

If the lint filter has not already been cleaned, lift out the filter and remove the lint from the last load. This will help ensure the fastest and most efficient drying performance. Make sure to reinstall the filter, pressing down until it clicks firmly into place. The dryer will not operate without the lint filter in place.

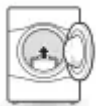

#### 2 Load the Dryer

Load the dryer with the wet laundry from the washer. If the load is extra large, you may need to divide it into smaller loads for proper performance and fabric care.

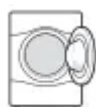

#### 3 Turn on The Dryer

Press the POWER button to turn ON the dryer. The cycle LEDs will illuminate and a chime will sound.

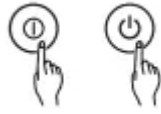

#### 4 Select a Cycle

Turn the cycle selector knob in either direction until the LED for the desired cycle is on. The preset temperature, dry level, and option settings for that cycle will be shown. Default settings for the selected cycle can now be changed if desired. Refer to the Cycle Setting and Options page for details.

NOTE: Not all options or modifiers are available on all cycles. A different chime will sound and the LED will not come on if the selection is not allowed.



#### 5 Begin the Cycle

Press the START/PAUSE button to begin the cycle. The cycle can be paused at any time either by opening the door or by pressing the START/PAUSE button.

If the cycle is not restarted within 60 minutes of being paused, the dryer will shut off and the settings will be lost.



#### 6 End of Cycle

When the cycle is finished, the chime will sound. Immediately remove your clothing from the dryer to reduce wrinkling. If Wrinkle Care is selected, the dryer will tumble briefly every few minutes to help prevent wrinkles from setting in the clothes.



### **Check the Lint Filter Before Every Load**

Always make sure the lint filter is clean before starting a new load; a clogged lint filter will increase drying time. To clean, pull the lint filter straight up and roll any lint off the filter with your fingers. Do not rinse or wash the filter to remove lint. Push the lint filter firmly back into place. See Regular Cleaning for more information.

Always ensure the lint filter is properly installed before running the dryer. Running the dryer with a loose or missing lint filter will damage the dryer and articles in the dryer.

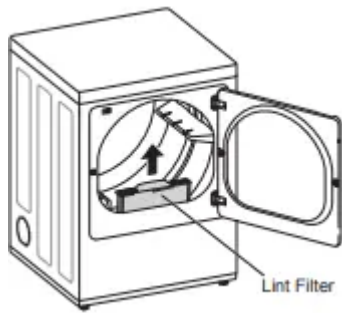

## Sorting Loads

### Fabric Care Labels

Most articles of clothing feature fabric care labels that include instructions for proper care.

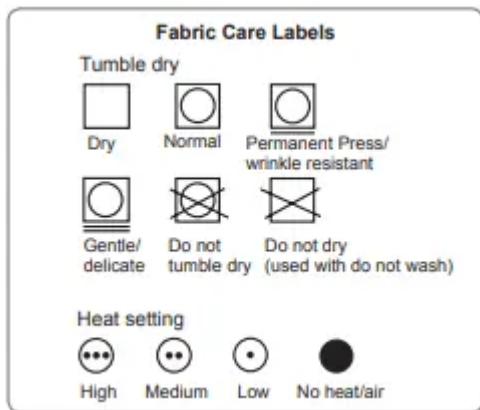

### Group Similar Items

For best results, sort clothes into loads that can be dried with the same drying cycle.

Different fabrics have different care requirements, and some fabrics will dry more quickly than others. For best fabric care results, always dry fabrics with similar care requirements together.

## Loading the Dryer

Warning: To reduce the risk of fire, electric shock, or injury to persons when using this appliance, follow basic precautions, including the following:

- Check all pockets to make sure that they are empty. Items such as clips, pens, coins, and keys can damage both your dryer and your clothes. Flammable objects such as lighters or matches could ignite, causing a fire. Failure to do so may result in fire, explosion, or death.

- Never dry clothes that have been exposed to oil, gasoline, or other flammable substances. Washing clothes will not completely remove oil residues. Failure to obey this warning may result in fire, explosion, or death.

#### Loading Tips

- Combine large and small items in the same load.
- Damp clothes will expand as they dry. Do not overload the dryer; clothes require room to tumble and dry properly.
- Close zippers, hooks, and drawstrings to prevent these items from snagging or tangling on other clothes.

#### Using the LG EasyLoad™

##### Swing Door

Use the swing door when unloading, or when loading bulkier items, for easy access to the drum.

To open the swing door, grasp the top of the door on the side opposite the hinge and pull.

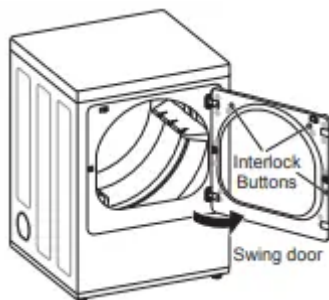

##### Warning

Do not press the three interlock buttons when the door is open. The door may fall off and cause serious injury.

- Do not place heavy items on or lean against the top of the door when it is open.

The dryer could tip forward, causing injury or property damage.

##### Hamper Door (on some models)

Use the hamper door when loading. The hamper door opens about 40 degrees and acts as a chute to help guide items into the drum and help prevent items from falling onto the floor. It also comes in handy when unloading a few small items, helping prevent the rest of the laundry from being pulled onto the floor.

To open the hamper door, press the release on the top of the door and pull the door forward.

Make sure laundry is fully inserted in the drum before closing the door.

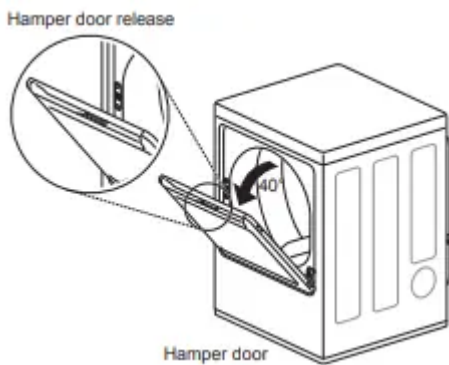

**Warning**

- Do not attempt to pull the hamper door open more than 40 degrees.
- Be careful when opening and closing the door. Fingers and hands can get caught in the door and cause injury if the door drops forward unexpectedly.

**Control Panel**

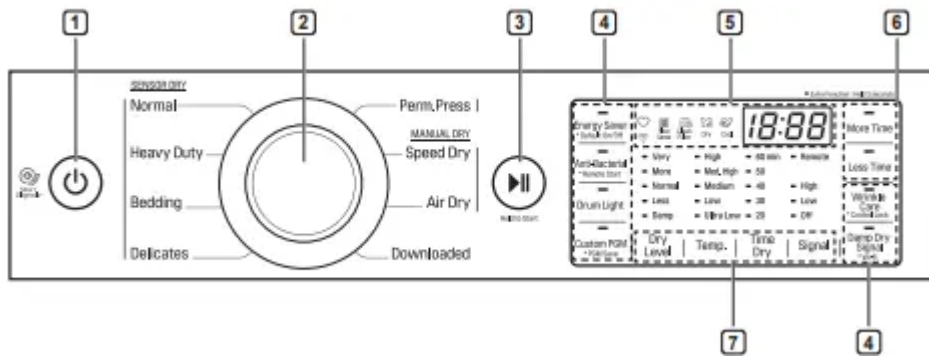

**1 POWER Button** Press to turn the dryer ON. Press again to turn the dryer OFF.

**2 Cycle Selector Knob** Turn this knob to select the desired cycle. Once the desired cycle has been selected, the standard presets are shown in the display. On Manual Dry cycles, these settings can be adjusted using the cycle modifier buttons any time before starting the cycle.

**3 START/PAUSE Button** Press this button to start the selected cycle. If the dryer is running, use this button to pause the cycle without losing the current settings.

**4 Cycle Option Buttons** The option buttons allow you to select additional cycle options. Certain buttons also allow you to activate special functions by pressing and holding the button for 3 seconds.

**5 Time and Status Display** The display shows the settings, estimated time remaining, options, and status messages for the dryer.

**6 MORE TIME/LESS TIME Buttons** Use these buttons with the Time Dry and other Manual Dry cycles to adjust the drying time. Press the MORE TIME button to increase the selected manual cycle time by 1 minute; press the LESS TIME button to decrease the cycle time by 1 minute.



**7 Cycle Modifier Buttons** Use these buttons to select the desired cycle settings for the selected cycle. The current settings are shown in the display. Press the button for that modifier to select other settings.

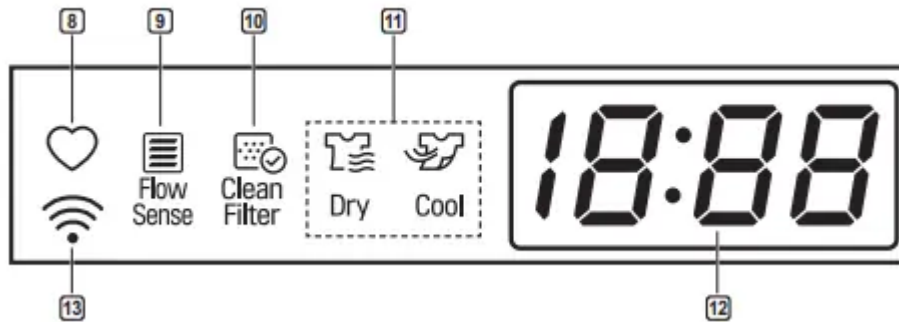

**8 Custom PGM** If you have a special combination of settings that you use frequently, you can save these settings as a

**9 Custom Program. Flow Sense™ Duct Blockage Sensing System Indicator** The Flow Sense™ duct blockage sensing system detects and alerts you to blockages in the ductwork that reduce exhaust flow from the dryer. Maintaining a clean exhaust system improves operating efficiency and helps minimize service calls, saving you money.

**10 Clean Filter Reminder** The display will show Clean Filter when the dryer is turned on as a reminder to check the filter. It turns off when the START/PAUSE button is pressed.

**11 Cycle Completion Indicator with Check Filter Reminder** This portion of the display shows which stage of the drying cycle is currently underway (Dry, Cool)

**12 Estimated Time Remaining** This display shows the estimated time remaining for SENSOR DRY cycles or the actual time remaining for Time Dry or MANUAL DRY cycles

**13 WI-FI Indicator** When the appliance is connected to the internet through a home Wi-Fi network, this indicator appears

### Cycle Guide

- = default setting
- = allowable option

Cycle	Fabric Type	Dry Level	Temp.	More Time/ Less Time	Anti-bac- terial	Wrinkle Care	Damp Dry Signal	Energy Saver
Bedding	Comforters, pillows, shirts	Normal Dry	Medium					
		Adjustable						
Heavy Duty	Jeans, heavyweight items	Normal Dry	High		○	○	○	
		Adjustable						
Normal	Work clothes, corduroys, etc.	Normal Dry	Med. High		○	○	○	○
		Adjustable						
Perm. Press	Permanent press, synthetic items	Normal Dry	Medium			○	○	
		Adjustable						
Delicates	Lingerie, sheets, blouses	Normal Dry	Low			○	○	
		Adjustable						
Speed Dry	For small loads with short drying times	Off	High	○		○		
			Adjustable					
Air Dry	For items that require heat-free drying such as plastics or rubber	Off	No Heat	○		○		

### Sensor dry cycles

Sensor dry cycles utilize LG's unique dual sensor system to detect and compare the moisture level in clothes and in the air and adjust the drying time as needed to ensure superior results. The dryer automatically sets the dryness level and temperature at the recommended setting for each cycle. The estimated time remaining will be shown in the display.

#### NOTE

To protect your garments not every dryness level, temperature, or option is available with every cycle. See the Cycle Guide for details.

### Downloaded

If you download a cycle using the Smart ThinQ application, it will be placed in the downloaded cycle position. Choose the Downloaded cycle to run the downloaded cycle.

### Manual dry cycles

Use manual dry cycles to select a specific amount of drying time and a drying temperature. When a manual dry cycle is selected, the Estimated Time Remaining display shows the actual time remaining in your cycle. You can change the actual time in the cycle by pressing More Time or Less Time.

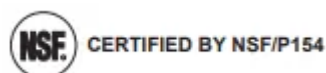

NSF International (formerly the National Sanitation Foundation), certifies that the Anti Bacterial cycle reduces 99.9% of bacteria on laundry, and none of the bacteria will carry over onto the next laundry load.

- The default settings for the Anti Bacterial cycle are High temperature and Very Dry. These default settings cannot be changed.

- Do NOT use this cycle with delicate items or fabrics.

## Cycle Settings and Options

### Cycle Modifier Buttons

SENSOR DRY cycles have preset settings that are selected automatically. MANUAL DRY cycles have default settings, but you may also customize the settings using the cycle modifier buttons. Press the button for that option to view and select other settings.

### Dry Level

Selects the level of dryness for the cycle. Press the Dry Level button repeatedly to scroll through available settings.

- This option is only available with SENSOR DRY cycles.
- The dryer will automatically adjust the cycle time. Selecting More Dry or Very Dry will increase the cycle time, while Less Dry or Damp Dry will decrease the cycle time.
- Use a Less Dry or Damp Dry setting for items that you wish to iron.

### Temp.

Adjusts the temperature setting. This allows precise care of your fabrics and garments. Press the Temp. button repeatedly to scroll through available settings.

### Time Dry

Allows you to manually select the drying time, from 20 to 60 minutes, in 10-minute increments. Use this for small loads or to remove wrinkles.

### More Time/Less Time

Use the More Time/Less Time buttons to add or reduce the drying time of a MANUAL DRY cycle in minute increments.

### Signal (Option)

Press the Signal (Option) button repeatedly to change the volume or turn on/off the button tones and the end of cycle melody.

### Cycle Option Buttons

The dryer features several additional cycle options to customize cycles to meet individual needs. Certain option buttons also feature a special function that can be activated by pressing and holding that option button for 3 seconds. (See Special Functions on the following page for details.)

Adding Cycle Options to a Cycle:

1. Turn on the dryer and turn the cycle selector knob to select the desired cycle.
2. Use the cycle modifier buttons to adjust the settings for that cycle.

3. Press the cycle option button(s) for the option you would like to add. A confirmation message is shown in the display.
4. Press the START/PAUSE button to start the cycle. The dryer starts automatically.

### **Wrinkle Care**

Selecting this option will tumble the load periodically for up to 3 hours after the selected cycle, or until the door is opened. This is helpful in preventing wrinkles when you are unable to remove items from the dryer immediately.

### **Damp Dry Signal**

With this option, the dryer will signal when the load is approximately 80% dry. This allows you to remove faster-drying lightweight items or items that you would like to iron or hang while still slightly damp.

## **Special Functions**

Some cycle option buttons also activate secondary functions. These special functions are marked with an asterisk (\*). Press and hold the option button marked with the special function to activate it.

### **Drum Light**

The drum is equipped with a blue LED that illuminates when the dryer is turned on. This light automatically turns off when the door is closed and the cycle starts.

To turn on the light during a cycle, press the Drum Light button. The drum light will illuminate and then turn off automatically after four minutes.

### **Control Lock**

Use this option to prevent unwanted use of the dryer or to keep cycle settings from being changed while the dryer is operating.

Press and hold the button marked Control Lock for seconds to activate or deactivate the Control Lock function. The Control Lock icon will be shown in the display, and all controls will be disabled except the POWER button.

### **NOTE**

Once set, Control Lock remains active until it is manually deactivated. Control Lock must be turned off to run another cycle. To deactivate Control Lock, press and hold the Control Lock button for 3 seconds.

### **Energy Saver (on some models)**

This option helps to reduce energy consumption in the Normal cycle, depending on the load size.

When the Energy Saver option is selected, the cycle begins with an air dry section and the drying time is increased.

## NOTE

The Energy Saver option is turned on by default in the Normal cycle. Turn off the Energy Saver option for a faster Normal cycle which begins with heated drying.

### **Default On/Off**

This option allows the Energy Saver settings to be changed. To run a Normal cycle without the Energy Saver option, press and hold the Energy Saver button for three seconds. ON or OFF appears in the display.

### **Custom PGM**

If you have a special combination of settings that you use frequently, you can save these settings as a custom program.

Saving a Custom Program:

1. Turn on the dryer and turn the cycle selector knob to select the desired cycle.
2. Use the cycle setting buttons to adjust the settings for that cycle.
3. Press the cycle option button(s) for the option you would like to add. A confirmation message will be shown in the display.
4. Press and hold the Custom PGM button for 3 seconds.

## NOTE

You may save only one custom program at a time. Pressing and holding the Custom PGM button will overwrite any previously saved custom program.

Recalling a Custom Program:

1. Turn on the dryer.
2. Press the Custom PGM button.
3. Press the START/PAUSE button to start the cycle.

## **SMART FUNCTIONS**

### **Smart ThinQ Application**

The Smart ThinQ application allows you to communicate with the appliance using a smartphone.

#### **Installing Smart ThinQ Application**

Search for the LG Smart ThinQ application from the Google Play Store or Apple App Store on a smart phone. Follow instructions to download and install the application.

#### **Smart ThinQ Application Features**

- For appliances with the  or logo 

### **Dryer Cycle (Remote Start, Downloaded)**

Set or download any preferred cycle and operate by remote control.

### **Smart Pairing**

This function automatically selects the best cycle and settings for the dryer based on usage information from the most recently completed wash cycle.

#### NOTE

- If the Smart Pairing function is enabled in the LG SmartThinQ app, when you turn on the dryer after using the washer, the recommended dryer cycle is automatically set.
- To use this function, both the washer and dryer must be connected to Wi-Fi.

### **Venting Tips**

Provides venting tips.

### **Smart Diagnosis™**

This function provides useful information for diagnosing and solving issues with the appliance based on the pattern of use.

### **Energy Monitoring**

The dryer energy usage is affected by the cycles and options so you may see some changes in energy usage from one cycle to another.

### **Push Alerts**

When the cycle is complete or the appliance has problems, you have the option of receiving push notifications on a smart phone.

### **Settings**

Set the product nickname and delete product.

#### NOTE

- To verify the Wi-Fi connection, check that Wi-Fi icon on the control panel is lit.
- LG Smart ThinQ is not responsible for any network connection problems or any faults, malfunctions, or errors caused by network connection.
- The machine supports 2.4 GHz Wi-Fi networks only.
- If the appliance is having trouble connecting to the Wi-Fi network, it may be too far from the router. Purchase a Wi-Fi repeater (range extender) to improve the Wi-Fi signal strength.
- The Wi-Fi connection may not connect or may be interrupted because of the home network environment.

- The network connection may not work properly depending on the internet service provider.
- The surrounding wireless environment can make the wireless network service run slowly.
- This information is current at the time of publication. The application is subject to change for product improvement purposes without notice to users.

## Using Dryer Cycle

### Remote Start

Use a smart phone to control the appliance remotely or check to see how much time is left in the cycle.

### Using Remote Start

1. Press the POWER button.
2. Load the laundry.
3. Press and hold Remote Start button for 3 seconds to enable the Remote Start function.
4. Start a cycle from the LG Smart ThinQ application on your smart phone.

### NOTE

- Once the Remote Start mode is enabled, you can start a cycle from the LG Smart ThinQ smartphone application. If the cycle is not started, the machine will wait to start the cycle until it is turned off remotely from the application or the Remote Start mode is disabled.
- If the door is open, Remote Start is disable.

### Disabling Remote Start

When the Remote Start is activated, press and hold the Remote Start button for 3 seconds.

### Downloaded

Download new and special cycles that are not included in the basic cycles on the appliance.

Appliances that have been successfully registered can download a variety of specialty cycles specific to the appliance. Only one cycle can be stored on the appliance at a time.

Once cycle download is completed in the appliance, the appliance keeps the downloaded cycle until a new cycle is downloaded.

### Wireless LAN Module Specifications

<b>Model</b>	LCW-004
<b>Frequency Range</b>	2412 MHz to 2462 MHz
<b>Output Power (Max)</b>	IEEE 802.11b: 22.44 dBm IEEE 802.11g: 24.68 dBm IEEE 802.11n: 24.11 dBm

### **FCC Notice (For transmitter module contained in this product)**

This equipment has been tested and found to comply with the limits for a Class B digital device, pursuant to Part 15 of the FCC Rules. These limits are designed to provide reasonable protection against harmful interference in a residential installation. This equipment generates, uses, and can radiate radio frequency energy and, if not installed and used in accordance with the instructions, may cause harmful interference to radio communications. However, there is no guarantee that interference will not occur in a particular installation. If this equipment does cause harmful interference to radio or television reception, which can be determined by turning the equipment off and on, the user is encouraged to try to correct the interference by one or more of the following measures:

- Reorient or relocate the receiving antenna.
- Increase the separation between the equipment and the receiver.
- Connect the equipment to an outlet on a circuit different from that to which the receiver is connected.
- Consult the dealer or an experienced radio/TV technician for help.

This device complies with part 15 of the FCC Rules. Operation is subject to the following two conditions:

- 1) This device may not cause harmful interference and
- 2) This device must accept any interference received, including interference that may cause undesired operation of the device.

Any changes or modifications in construction of this device which are not expressly approved by the party responsible for compliance could void the user's authority to operate the equipment.

### **FCC RF Radiation Exposure Statement**

This equipment complies with FCC radiation exposure limits set forth for an uncontrolled environment. This transmitter must not be co-located or operating in conjunction with any other antenna or transmitter.

This equipment should be installed and operated with a minimum distance of 20 cm (7.8 inches) between the antenna and your body. Users must follow the specific operating instructions for satisfying RF exposure compliance.

### **Open Source Software Notice**



## Information

To obtain the source code under GPL, LGPL, MPL, and other open source licenses, that is contained in this product, please visit <http://opensource.lge.com>.

In addition to the source code, all referred license terms, warranty disclaimers and copyright notices are available for download.

LG Electronics will also provide open source code to you on CD-ROM for a charge covering the cost of performing such distribution (such as the cost of media, shipping, and handling) upon email request to [opensource@lge.com](mailto:opensource@lge.com). This offer is valid for three years from the date on which you purchased the product.

## Smart Diagnosis™ Function

Should you experience any problems with the appliance, it has the capability of transmitting data via your telephone to the LG Customer Information Center. NFC or Wi-Fi equipped models can also transmit data to a smartphone using the LG Smart ThinQ application.

### Smart Diagnosis™ through the Customer Information Center

- For appliances with the  or logo 

This gives you the capability of speaking directly to our trained specialists. The specialist records the data transmitted from the appliance and uses it to analyze the issue, providing a fast and effective diagnosis.



1. Call the LG Electronics Customer Information Center at: (LG U.S.A.) 1-800-243-0000 (LG Canada) 1-888-542-2623
2. When instructed to do so by the call center, place the mouthpiece of the phone close to the Smart Diagnosis™ icon. Do not press any other buttons.
3. Press and hold the Temp. button for 3 seconds.
4. Keep the phone in place until the tone transmission has finished.
5. Once the countdown is over and the tones have stopped, resume your conversation with the call center agent, who will then be able to assist you using the information transmitted for analysis.

### NOTE

- Smart Diagnosis™ cannot be activated unless the appliance can be turned on using the Power button. If the appliance cannot be turned on, troubleshooting must be done without using Smart Diagnosis™.
- For best results, do not move the phone while the tones are being transmitted.
- If the call center agent is not able to get an accurate recording of the data, you may be asked to try again.
- The Smart Diagnosis™ function depends on the local call quality.

- Bad call quality may result in poor data transmission from your phone to the call center, which could cause Smart Diagnosis™ to malfunction.

### **Smart ThinQ Smart Diagnosis™**

- For appliances with the  or logo 

Use the Smart Diagnosis feature in the Smart ThinQ application for help diagnosing issues with the appliance without the assistance of the LG Customer Information Center.

Follow the instructions in the Smart ThinQ application to perform a Smart Diagnosis using your smartphone.

## **MAINTENANCE**

### **Regular Cleaning**

#### Warning

To reduce the risk of fire, electric shock, or injury to persons when using this appliance, follow basic precautions, including the following:

- Unplug the dryer before cleaning to avoid the risk of electric shock. Failure to follow this warning may cause serious injury, fire, electric shock, or death.
- Never use harsh chemicals, abrasive cleaners, or solvents to clean the washer. They will damage the finish.

### **Cleaning the Exterior**

Proper care of your dryer can extend its life. The outside of the machine can be cleaned with warm water and a mild, nonabrasive household detergent. Immediately wipe off any spills with a soft, damp cloth.

#### NOTE

- Do not use methylated spirits, solvents, or similar products.
- Never use steel wool or abrasive cleansers; they can damage the surface.

### **Cleaning the Interior**

Wipe around the door opening and seal with a soft, damp cloth to prevent lint and dust buildup that could damage the door seal.

Clean the window with a soft cloth dampened with warm water and a mild, nonabrasive household detergent, then wipe dry.

The stainless steel drum can be cleaned with a conventional stainless steel cleaner, used according to the manufacturer's specifications. Never use steel wool or abrasive cleansers; they may scratch or damage the surface.

## Cleaning Around and Under the Dryer

Vacuum lint and dust from around the dryer and underneath it regularly. Vent ductwork should be checked for lint buildup and cleaned at least once per year. If any noticeable reduction in airflow or drying performance occurs, immediately check ductwork for obstructions and blockages.

## Maintaining Ductwork

Vent ductwork should be checked for lint buildup once per month and cleaned at least once per year. If any noticeable reduction in airflow or drying performance occurs, immediately check ductwork for obstructions and blockages. Contact a qualified technician or service provider.

## Cleaning the Lint Filter

Always clean the lint from the filter after every cycle.

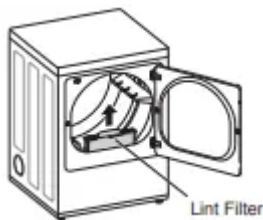

To clean, open the dryer door and pull the lint filter straight up. Then:

1 For everyday cleaning, roll any lint off the filter with your fingers, or



2 Vacuum the lint filter.

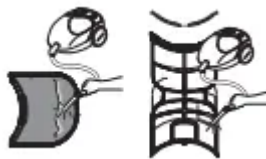

3 If the lint filter has become very dirty or clogged with fabric softener, wash the lint filter in warm, soapy water and allow it to dry thoroughly before reinstalling.



## NOTE

NEVER operate the dryer without the lint filter in place. NEVER operate the dryer with a wet lint filter.

# Troubleshooting

## FAQs: Frequently Asked Questions

Q: When I press a button, why does my dryer beep and then nothing happens?

A: The Control Lock feature is turned on. To turn off Control Lock, turn the dryer on, then press and hold the button that has \*Control Lock on or under it for 3 seconds.

Q: Why does my dryer take so long to dry clothes?

A: Proper airflow is critical to the efficient operation of clothes dryers. A lint filter which is full of lint or clogged with fabric softener sheet residue can reduce the airflow to the point that the time required to dry clothing will be greatly increased. Another factor affecting dry time is your home exhaust system. An exhaust system which is dirty and clogged with lint, or is excessively long, needs to be professionally cleaned or repaired.

Q: Why does my dryer start by itself every few minutes?

A: This is how the Wrinkle Care feature works. The dryer runs briefly every few minutes for up to 3 hours after the cycle finishes. This feature is designed to help prevent wrinkles from setting in when the dryer is not unloaded immediately after the cycle is finished.

## User Support Videos

For further assistance, there are videos and tutorials available through the LG.com website.

1. On the lg.com/us home page, click on the Support menu tab to bring up the menu selections. Select Video Tutorials.
2. Select Appliances and Dryers in the search menu on the new page. Scan this QR code to quickly access the video search page on the LG website.



Scan this QR code to quickly access the video search page on the LG website. Once there, select Appliances and Dryers in the search box.

## Before Calling for Service

This dryer is equipped with an automatic error-monitoring system to detect and diagnose problems at an early stage. If the dryer does not function properly or does not function at all, check the following before you call for service.

## Operation

Problem	Possible Cause	Solutions
<p><b>The Flow Sense™1 indicator remains active after clearing the restriction in the venting.</b></p>	<p><b>After clearing the restriction, the Flow Sense™1 system requires multiple, consecutive cycles to determine that the performance value has improved before the Flow Sense™1 indicator is reset.</b></p>	<p>If the Flow Sense™ indicator remains active for more than five cycles after the restriction has been cleared, call for service.</p>
<p><b>Dryer will not turn on</b></p>	<p><b>Power cord is not properly plugged in.</b></p>	<p>Make sure that the plug is securely plugged into a grounded outlet matching the dryer's rating plate.</p>
	<p><b>House fuse is blown, circuit breaker has tripped, or power outage has occurred.</b></p>	<p>Reset circuit breaker or replace fuse. Do not increase fuse capacity. If the problem is a circuit overload, have it corrected by a qualified electrician.</p>
<p><b>Dryer does not heat</b></p>	<p><b>house fuse is blown, circuit breaker has tripped, or power outage has occurred.</b></p>	<p>Reset circuit breaker or replace fuse. Do not increase fuse capacity. If the problem is a circuit overload, have it corrected by a qualified electrician.</p> <p><b>NOTE</b></p> <p>Due to the design of electric dryers, it is possible for a circuit problem to allow an electric dryer to run without heat.</p>
	<p><b>Gas supply or service is turned off (gas models only).</b></p>	<p>Confirm that the house gas shutoff and the dryer gas shutoff valves are both fully open. Even if gas is not supplied to the dryer, it will run and display error code. Verify that other gas appliances in the home are working normally.</p>



	<b>Energy Saver option selected (on some models)</b>	If using the Cotton/Normal cycle, deselect the energy saver option. The Energy Saver option is selected by default. This option reduces energy use by adding an air dry section to the beginning of the cycle. It is normal to feel no heat at the beginning of the cycle while in Energy Saver mode.
<b>Display show error code nP</b>	<b>Electric dryer power cord is not connected correctly, or house power supply is incorrect.</b>	Check the power supply or the connection of the power cord to the terminal block.
<b>Display show error code gAS</b>	<b>gas supply or service turned off (gas models only).</b>	Confirm that house gas shutoff and the dryer gas shutoff are both fully open.



<p><b>Clothes take too long to dry</b></p>	<p><b>Exhaust ducts are blocked, dirty, or duct run is too long.</b></p>	<p>Confirm that the exhaust duct is properly configured and free of debris, lint, and obstructions. Make sure that outside wall dampers can open properly and are not blocked, jammed, or damaged.</p>
	<p><b>Load is not properly sorted.</b></p>	<p>Separate heavy items from lightweight items. Larger and heavier items take longer to dry. Light items in a load with heavy items can fool the sensor because the light items dry faster.</p>
<p><b>Clothes take too long to dry</b></p>	<p><b>Large load of heavy fabrics.</b></p>	<p>Heavy fabrics take longer to dry because they tend to retain more moisture. To help reduce and maintain more consistent drying times for large and heavy fabrics, separate these items into smaller loads of a consistent size.</p>
	<p><b>Dryer controls are not set properly.</b></p>	<p>Use the appropriate control settings for the type of load you are drying. Some loads may require an adjustment of the dry level setting for proper drying.</p>
	<p><b>Lint filter needs to be cleaned.</b></p>	<p>Remove the lint from the filter before every load. With the lint removed, hold the filter up to a light to see if it is dirty or clogged. With some loads that produce high amounts of lint, such as new bath towels, it may be necessary to pause the cycle and clean the filter during the cycle.</p>



	<p><b>House fuse is blown, circuit breaker has tripped, or power outage has occurred.</b></p>	<p>Reset circuit breaker or replace fuse. Do not increase fuse capacity. If the problem is a circuit overload, have it corrected by a qualified electrician.</p> <p><b>NOTE</b></p> <p>Due to the design of electric dryers, it is possible for a circuit problem to allow an electric dryer to run without heat.</p>
	<p><b>Dryer is overloaded.</b></p>	<p>Divide extra large loads into smaller loads for better drying performance and efficiency.</p>
	<p><b>Dryer is underloaded.</b></p>	<p>If you are drying a very small load, add a few extra items to ensure proper tumbling action. If the load is very small and you are using SENSOR DRY cycles, the electronic control cannot properly sense the dryness of the load and may shut off too soon. Use TIME DRY or add some extra wet clothes to the load.</p>



<p><b>Clothes take too long to dry</b></p>	<p><b>Energy Saver option selected (on some models)</b></p>	<p>If using the Cotton/Normal cycle, deselect the Energy Saver option. This option reduces energy use by adding an air dry section to the beginning of the cycle.</p>
<p><b>Drying time is not consistent</b></p>	<p><b>Heat settings, load size, or dampness of clothing is not consistent.</b></p>	<p>The drying time for a load will vary depending on the type of heat used (electric, natural gas, or LP gas), the size of the load, the type of fabrics, the wetness of the clothes, and the condition of the exhaust duct and lint filter. Even an unbalanced load in the washer can cause poor spinning, resulting in wetter clothes which will take longer to dry.</p>

## Error Codes

### Error code: tE1 through tE

- Temperature sensor failure.
  - Turn off the dryer and call for service.

### Display shows error code: PS (electric dryers only)

- Power cord is connected incorrectly.
  - Check the connection of the power cord to the terminal block.

### Flow Sense™ indicator shows four bars during the drying cycle or the display shows "d80" after drying

- Exhaust system is too long or has too many turns/restrictions.
  - Install a shorter or straighter duct run. See the Installation Instructions for details.
- Partial blockage of the ductwork due to lint buildup or other foreign object.
  - Ductwork should be checked/cleaned immediately. Dryer can be used in this condition, but drying times will be longer and energy consumption will increase.

**This warning light is not a dryer failure and is not covered by the dryer warranty. Contact a duct cleaning service to set up an appointment to have your exhaust system cleaned and inspected.**

- The appliance has detected a restriction in the external dryer venting.
  - If exhaust restrictions are sensed by the Flow Sense™ system, the indicator will remain on for 2 hours after the end of the cycle. Opening the door or pressing the POWER button will turn off the display.

**The Flow Sense™ indicator remains active after clearing the restriction in the venting.**

- After clearing the restriction, the Flow Sense™ system requires multiple, consecutive cycles to determine that the performance value has improved before the Flow Sense™ indicator is reset.
  - If the Flow Sense™ indicator remains active for more than five cycles after the restriction has been cleared, call for service.



**indicator light is on during the drying cycle**

- Lint filter not cleaned properly.
  - Remove the lint from the filter before every load. With the lint removed, hold the filter up to a light to see if it is dirty or clogged. If it looks dirty, follow the cleaning instructions. With some loads that produce high amounts of lint, it may be necessary to clean the filter during the cycle.

The display shows d90, d95 

- The duct work is about 90%-95% blocked. ("d90" or "d95" error code is displayed for 2 hours only)
  - Do not use the dryer until the exhaust system has been cleaned and/or repaired.
  - Using the dryer with a severely restricted exhaust is dangerous and could result in a fire or other property damage.
- House exhaust system blocked.
  - Check the outside dryer vent while the dryer is operating to make sure there is strong airflow.
  - If the exhaust system is extremely long, have it repaired or rerouted.
  - Keep the area around the dryer clean and free of clutter.
  - Check vent hood for damage or lint clogging.

- Make sure the area around the vent hood is clear

**Warning**

This content is compiled from multiple sources and is provided for reference purposes only. It may not be complete or fully applicable to all situations. If you are unable to resolve your issue, please contact the product manufacturer or an authorized service provider for official support.

---

Document generated by [ManualsFile](#)