

USING YOUR OVEN

Features

Throughout this manual, features and appearance may vary from your model.

700 Watts

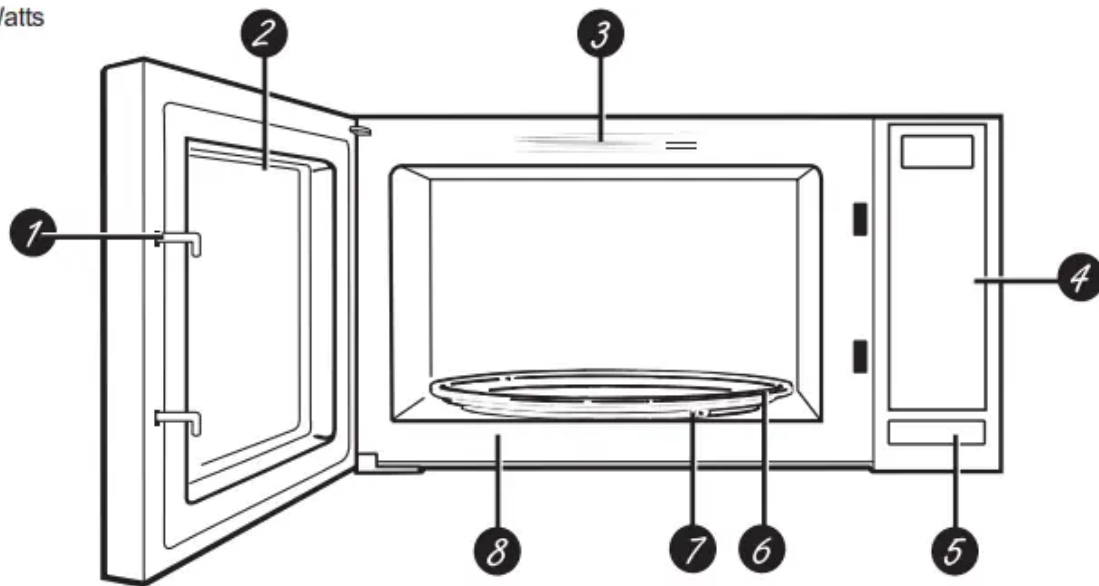

1. **Door Latches**
2. **Window with Metal Shield.** Screen allows cooking to be viewed while keeping microwaves confined in the oven.
3. **Convenience Guide**
4. **Touch Control Panel Display**
5. **Door Latch Release.** Press latch release to open door.
6. **Removable Turntable.** Turntable and support must be in place when using the oven. The turntable may be removed for cleaning.
7. **Removable Turntable Support.** The turntable support must be in place when using the oven.
8. **Rating Plate.**

Controls

You can microwave by time or with the convenience features.

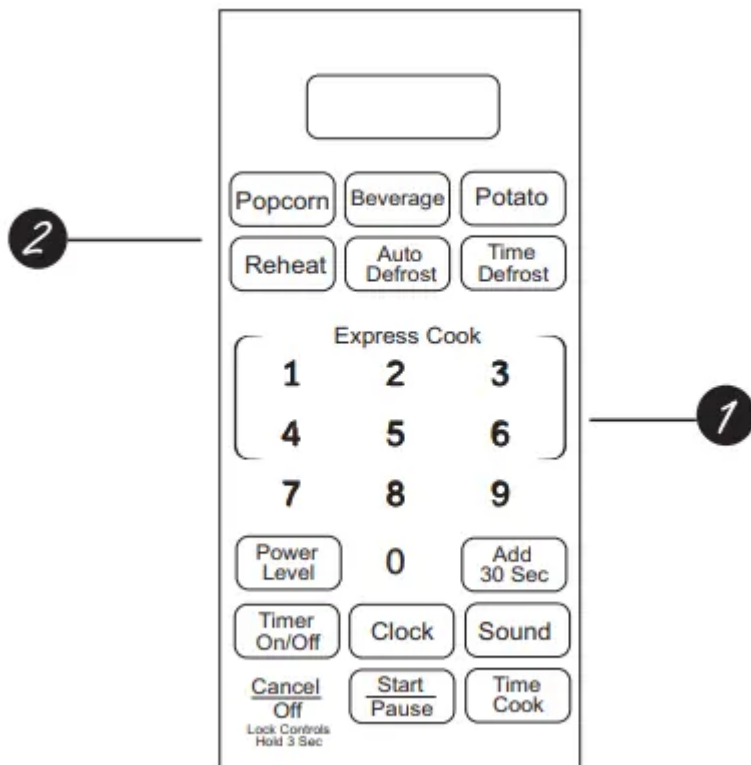

Check the Convenience Guide before you begin.

1. Time Features

Press - Enter

Time Cook - Amount of cooking time Press number pads

Time Defrost - Amount of defrosting time

Power Level - Power level 0 to 10

Add 30 Sec - Starts immediately!

Express Cook - Starts immediately!

2. Convenience Features

Press	Enter	Option
Potato	Enter serving size	1-4 servings
Popcorn	Enter serving size	3.0 oz or 2.5 oz
Beverage Press once, twice or three times	Enter serving size	4 oz, 8 oz or 12 oz
Reheat Press once	Food Type 1-3	1-3 servings
Auto Defrost	Food Weight (0.1-6 lbs)	

Changing the power level

Changing the Power Level: the power level can be changed only when using Time Cook or Time Defrost buttons and is explained in the sections for the functions of these buttons.

1. Press Power Level repeatedly to select power level 0-10.
2. Enter cooking time.
3. Press Start

Variable power levels add flexibility to microwave cooking. The power levels on the microwave oven can be compared to the surface units on a range. Each power level gives you microwave energy a certain percent of the time. Power level 7 is microwave energy 70% of the time. Power level 3 is energy 30% of the time. Most cooking will be done on power level 10 which gives you 100% power. Power level 10 will cook faster but food may need more frequent stirring, rotating or turning over. A lower setting will cook more evenly and need less stirring or rotating of the food. Some foods may have better flavor, texture or appearance if one of the lower settings is used. Use a lower power level when cooking foods that have a tendency to boil over, such as scalloped potatoes.

Rest periods (when the microwave energy cycles off) give time for the food to “equalize” or transfer heat to the inside of the food. An example of this is shown with power level 3—the defrost cycle. If microwave energy did not cycle off, the outside of the food would cook before the inside was defrosted. Here are some examples of uses for various power levels:

10: Fish, bacon, vegetables, boiling liquids.

Med-High 7: Gentle cooking of meat and poultry; baking casseroles and reheating.

Medium 5: Slow cooking and tenderizing for stews and less tender cuts of meat.

Low 2 or 3: Defrosting; simmering; delicate sauces.

Warm 1: Keeping food warm; softening butter.

Time Cook

Allows you to microwave for any time up to 99 minutes and 99 seconds.

Power level 10 is automatically set, but you may change it for more flexibility.



1. Press Time Cook.
2. Enter cooking time.
3. Press Start.

You may open the door during Time Cook to check the food. Close the door and press START to resume cooking.

Defrosting and Cooking

You can program the oven to automatically begin Time Cook after defrosting.

1. Press Auto Defrost and select food weight, or press Time Defrost and enter defrosting time.
2. Press Power Level. Change power level if you don't want full power. (Press Power Level repeatedly to select a desired power level.)
3. Enter the amount of cooking time.
4. Press Start.

The oven will begin defrosting. After defrosting is complete, Time Cook will count down.

Express Cook

This is a quick way to set cooking time from 1-6 minutes.

1. Press one of the Express Cook pads (from 1-6) for 1-6 minutes of cooking at power level 10. For example, press the 2 pad for 2 minutes of cooking time.



The power level can be changed as time is counting down. Press POWER LEVEL and enter 1-10.

NOTE: Express Cook function pertains to pads 1-6 only

Defrosting

Auto Defrost

Use Auto Defrost for meat, poultry and fish weighing up to 2.5 pounds. Use Time Defrost for most other frozen foods.

Auto Defrost automatically sets the defrosting times and power levels to give even defrosting results for meats, poultry and fish.

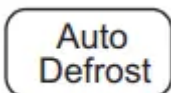

1. Press Auto Defrost repeatedly to select 1 to 2.5 pounds.
2. Then press the number pad to select between 0.1 to 6.0 pounds.
3. Press Start.

Time Defrost is explained in the About the time features section.)

There is a handy guide located on the inside front of the oven.

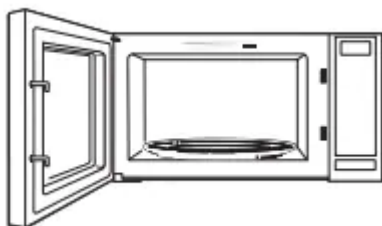

- Remove meat from package and place on microwavesafe dish.
- When the oven signals, turn the food over. Remove defrosted meat or shield warm areas with small pieces of foil.
- After defrosting, most meats need to stand 5 minutes to complete defrosting. Large roasts should stand for about 30 minutes.

Time Defrost

Allows you to defrost for a selected length of time. See the Defrosting Guide for suggested times.

(Auto Defrost explained in the About the convenience features section.)

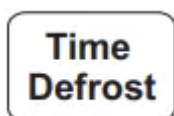

1. Press Time Defrost.

2. Enter defrost time.
3. Press Start.
4. Turn the food over after half the time.
5. Press Start/+30 Sec.

At one half of selected defrosting time, turn food over and break apart or rearrange pieces for more even defrosting. Shield any warm areas with small pieces of foil. The oven will continue to defrost if you don't open the door and turn the food.

A dull thumping noise may be heard during defrosting. This is normal when oven is not operating at power level 10.

Defrosting Tips

- Foods frozen in paper or plastic can be defrosted in the package. Closed packages should be slit, pierced or vented AFTER food has partially defrosted. Plastic storage containers should be partially uncovered.
- Family-size, prepackaged frozen dinners can be defrosted and microwaved. If the food is in a foil container, transfer it to a microwave-safe dish.
- Foods that spoil easily should not be allowed to sit out for more than one hour after defrosting. Room temperature promotes the growth of harmful bacteria.
- For more even defrosting of larger foods, such as roasts, use Auto Defrost. Be sure large meats are completely defrosted before cooking.
- When defrosted, food should be cool but softened in all areas. If still slightly icy, return to the microwave very briefly, or let it stand a few minutes.

Defrosting Guide

Food	Time	Comments
Breads, Cakes <i>Bread, buns, or rolls</i> (1 piece) <i>Sweet rolls</i> (approx. 12 oz.)	1/4 min. 2 to 4 min.	Rearrange after half the time.
Fish and Seafood <i>Fillet, frozen</i> (1 lb.) <i>Shellfish, small pieces</i> (1 lb.)	6 to 9 min. 3 to 7 min.	Place block in casserole. Turn over and break up after half the time.
Fruit <i>Plastic pouch—1 or 2</i> (10-oz. package)	1 to 5 min.	
Meat <i>Bacon</i> (1 lb.) <i>Franks</i> (1 lb.) <i>Ground meat</i> (1 lb.) <i>Roast: beef, lamb, veal, pork</i> <i>Steaks, chops and cutlets</i>	2 to 5 min. 2 to 5 min. 4 to 6 min. 9 to 13 min. per lb. 4 to 8 min. per lb.	Place unopened package in oven. Let stand 5 minutes after defrosting. Place unopened package in oven. Microwave just until franks can be separated. Let stand 5 minutes, if necessary, to complete defrosting. Turn meat over after first half of time. Use power level 10. Place unwrapped meat in cooking dish. Turn over after first half of time and shield warm areas with foil. After second half of time, separate pieces with table knife. Let stand to complete defrosting.
Poultry <i>Chicken, broiler-fryer, cut up</i> (2½ to 3 lbs.) <i>Chicken, whole</i> (2½ to 3 lbs.) <i>Cornish hen</i> <i>Turkey breast</i> (4 to 6 lbs.)	14 to 20 min. 20 to 25 min. 7 to 13 min. per lb. 3 to 8 min. per lb.	Place wrapped chicken in dish. Unwrap and turn over after first half of time. After second half of time, separate pieces and place in cooking dish. Microwave 2 to 4 minutes more, if necessary. Let stand a few minutes to finish defrosting. Place wrapped chicken in dish. After half the time, unwrap and turn chicken over. Shield warm areas with foil. To complete defrosting, run cold water in the cavity until giblets can be removed. Place unwrapped hen in the oven breast-side-up. Turn over after first half of time. Run cool water in the cavity until giblets can be removed. Place unwrapped breast in microwave-safe dish breast-side-down. After first half of time, turn breast-side-up and shield warm areas with foil. Defrost for second half of time. Let stand 1 to 2 hours in refrigerator to complete defrosting.

About the other features

Clock



Press to enter the time of day.

1. Press Clock.
2. Enter time of day.
3. Press Clock.

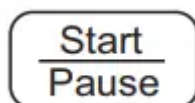

Pause

Start/Pause allows you to stop cooking without opening the door or clearing the display. Press Start/Pause again to restart the oven.

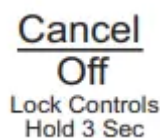

Child Lock-Out

You may lock the control panel to prevent the microwave from being accidentally started or used by children.

To lock or unlock the controls, press and hold Cancel/Off for about three seconds. When the control panel is locked, the lock indicator will be lit.

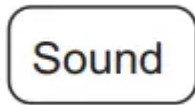

Sound

The beeper sound can be adjusted.

Press SOUND for mute or normal.

Timer

This pad performs the following functions:

- It operates as a minute timer.
- It can be used as a hold setting after defrosting.

How to Use as a Minute Timer

The Timer operates without microwave energy.

1. Press Timer.
2. Enter the amount of time you want to count down.
3. Press Timer. When the time is up, the timer will signal.



How to Set a delay start for Time Defrost

1. Press Auto Defrost and select food weight, or press Time Defrost and enter defrosting time.
2. Press Start.
3. Press Timer.
4. Enter the amount of time you want the oven to hold.
5. Press Start.

The oven will begin defrosting. After defrosting is complete, the holding time will count down.

To cancel, press the Timer. button.

When time is up, the oven will signal with beeps and "End" on display.

To turn off the timer signals, press Timer..

NOTE: Any options/settings menu is not accessible until the Timer End signals are cleared by pressing the Timer. pad.

CARE AND CLEANING

Helpful Hints

An occasional thorough wiping with a solution of baking soda and water keeps the inside fresh.

Unplug the cord before cleaning any part of this oven.



How to Clean the Inside

Walls, Floor, Inside Window, Metal and Plastic Parts on the Door

Some spatters can be removed with a paper towel; others may require a damp cloth. Remove greasy spatters with a sudsy cloth, then rinse with a damp cloth. Do not use abrasive cleaners or sharp utensils on oven walls.

To clean the surface of the door and the surface of the oven that come together upon closing, use only mild, nonabrasive soaps or detergents using a sponge or soft cloth. Rinse with a damp cloth and dry.

Never use a commercial oven cleaner on any part of your microwave.

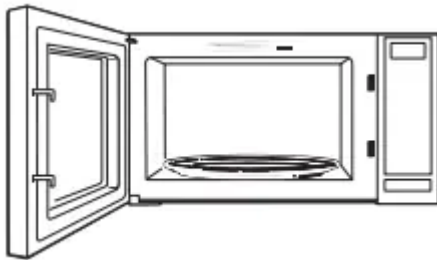

Removable Turntable and Turntable Support

To prevent breakage, do not place the turntable into water just after cooking. Wash it carefully in warm, sudsy water or in the dishwasher. The turntable and support can be broken if dropped. Remember, do not operate the oven in the microwave mode without the turntable and support seated and in place.



How to Clean the Outside

Do not use cleaners containing ammonia or alcohol on the microwave oven. Ammonia or alcohol can damage the appearance of the microwave.

Case

Clean the outside of the microwave with a sudsy cloth. Rinse with a damp cloth and then dry. Wipe the window clean with a damp cloth.

Control Panel and Door

Wipe with a damp cloth. Dry thoroughly. Do not use cleaning sprays, large amounts of soap and water, abrasives or sharp objects on the panel—they can damage it. Some paper towels can also scratch the control panel.

Door Surface

It is important to keep the area clean where the door seals against the microwave. Use only mild, nonabrasive detergents applied with a clean sponge or soft cloth. Rinse well.

Power Cord

If the cord becomes soiled, unplug and wash with a damp cloth. For stubborn spots, sudsy water may be used, but be certain to rinse with a damp cloth and dry thoroughly before plugging cord into outlet.

Stainless Steel (on some models)

Do not use a steel-wood pad; it will scratch the surface.

To clean the stainless steel surface, use a hot, damp cloth with a mild detergent suitable for stainless steel surfaces. Use a clean, hot, damp cloth to remove soap. Dry with a dry, clean cloth. Always scrub lightly in the direction of the grain.

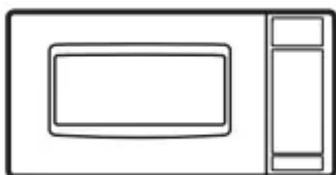

Troubleshooting Tips

Problem	Possible Cause
Oven will not come on	A fuse in your home may be blown or the circuit breaker tripped. Replace fuse or reset circuit breaker.
	Unplug your microwave oven, then plug it back in.
	Make sure 3-prong plug on oven is fully inserted into wall receptacle
Control panel lighted, yet oven will not start	Door not securely closed.
	Start must be pressed after entering cooking selection.
	Another selection entered already in oven and Cancel/Off not pressed to cancel it.
	Make sure you have entered cooking time after pressing Cook Time.
	Cancel/Off was pressed accidentally. Reset cooking program and press Start.
	Make sure you entered food weight after pressing Defrost Weight.
"FOOD" appears on display	Oven was paused accidentally. Press Start to restart the cooking program.
	The control detected that the door has not been opened (food/beverage has not been placed inside).
"LOC" appears on display	The control panel has been locked. (When the control panel is locked, "LOC" will be displayed.) Press and hold Cancel/Off for about 3 seconds to unlock the control panel.
"PF" appears on display	A Power Failure has occurred. Press Cancel/Off to clear the display

Things That Are Normal With Your Microwave Oven

- Steam or vapor escaping from around the door.
- Light reflection around door or outer case.
- Dimming oven light and change in the blower sound at power levels other than high.
- Dull thumping sound while oven is operating.

- TV/radio interference might be noticed while using the microwave. Similar to the interference caused by other small appliances, it does not indicate a problem with the microwave. Plug the microwave into a different electrical circuit, move the radio or TV as far away from the microwave as possible, or check the position and signal of the TV/radio antenna.

Microwave Terms

Term	Definition
Arcing	<p>Arcing is the microwave term for sparks in the oven. Arcing is caused by:</p> <ul style="list-style-type: none"> • metal or foil touching the side of the oven. • foil that is not molded to food (upturned edges act like antennas). • metal such as twist-ties, poultry pins, gold-rimmed dishes. • recycled paper towels containing small metal pieces. • plates or dishes with a metallic trim or glaze with a metallic sheen.
Covering	<p>Covers hold in moisture, allow for more even heating and reduce cooking time. Venting plastic wrap or covering with wax paper allows excess steam to escape.</p>
Shielding	<p>In a regular oven, you shield chicken breasts or baked foods to prevent over-browning. When microwaving, you use small strips of foil to shield thin parts, such as the tips of wings and legs on poultry, which would cook before larger parts.</p>
Standing Time	<p>When you cook with regular ovens, foods such as roasts or cakes are allowed to stand to finish cooking or to set. Standing time is especially important in microwave cooking. Note that a microwaved cake is not placed on a cooling rack.</p>
Venting	<p>After covering a dish with plastic wrap, you vent the plastic wrap by turning back one corner so excess steam can escape.</p>

Warning

This content is compiled from multiple sources and is provided for reference purposes only. It may not be complete or fully applicable to all situations. If you are unable to resolve your issue, please contact the product manufacturer or an authorized service provider for official support.