

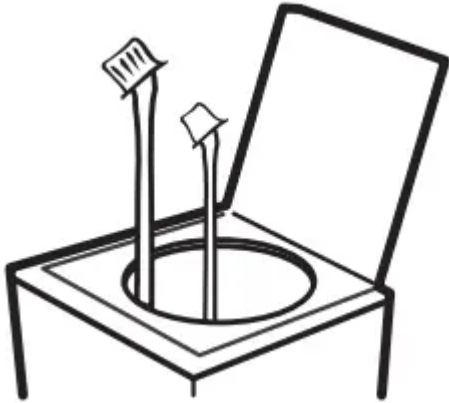

## Operating Instructions

### About the control panel—for models with START button



- Add fabric softener (on models with a fabric softener dispenser); see page 6 for details
- Add detergent. GE recommends the use of High Efficiency  detergents in all Energy Star-rated washers



- Add clothes
- Close lid

**NOTE:** Washer will not start to fill with lid open on Auto Load sensing settings (on some models)

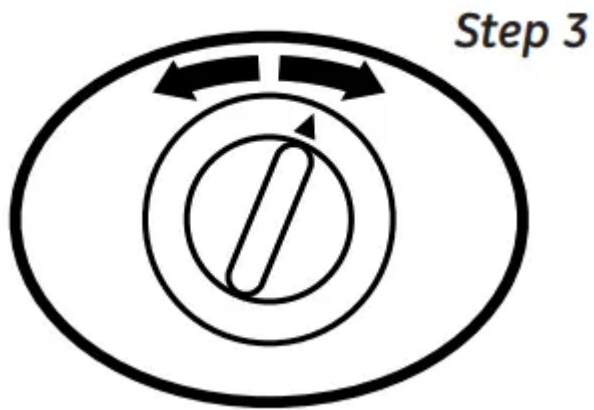

- Select load size and other wash options, including Fabric Softener option
- Select wash cycle

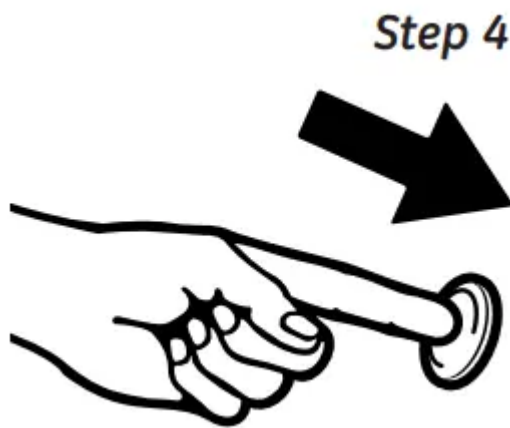

- Push START

## Quick Start Guide

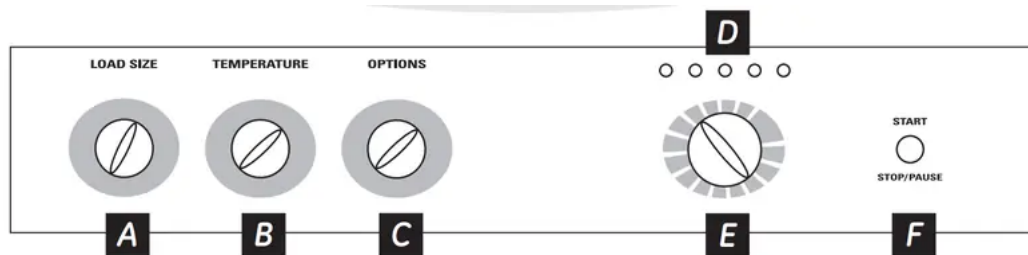

### Controls

#### A. Load Size

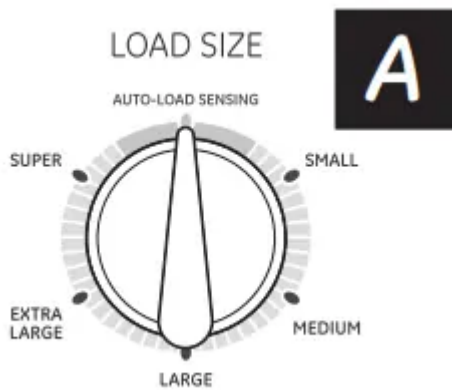

- Add detergent to the bottom of the basket and fabric softener to the dispenser prior to loading clothes.
- Loosely load clothes no higher than the top row of holes in the basket. For optimal performance, load items around the outside of the basket.
- Make the load selection:

#### **For AUTOMATIC LOAD SENSING equipped models**

- For convenience, best performance and optimal efficiency, select AUTOMATIC LOAD SENSING. This selection automatically provides the correct amount of water suited to the size and type of load placed in the unit.
- If you prefer to manually select the water level, select SMALL through SUPER. While AUTOMATIC LOAD SENSING is best for most loads and general washing, you may want to manually select the load size for specialty items such as bulky, lightweight comforters or pillows, where you want to ensure a larger water level is applied. Manual load size selections should be made for wet items placed in the washer, such as soaked towels or garments.
- The washer will not fill with water when automatic load sensing is selected if the lid is opened. When the lid is closed the machine is able to begin filling with water in order to sense the load size

#### **For standard fill equipped models**

- Select the load size that matches the load placed into the washer.
- For changing the water level to a higher level AFTER the unit has filled, turn load size knob to RESET, then turn the knob back to your new setting. DO NOT leave the knob in the RESET position.

**NOTE:** This is a high-efficiency washing machine with Infusor™ wash action. This system requires less water while providing effective cleaning action. You may notice that the water level is lower than on your previous washer. This is normal for an Infusor™-equipped washer. The water level will be just above the top of the Infusor™ when the SUPER WASH size is selected.

#### **B. Temperature**

Select the water temperature for the wash and rinse cycles. Always follow fabric manufacturer's care label or instructions when laundering.

PerfectTemp senses the incoming water temperature and adjusts the fill water to obtain a more precise temperature range for all wash temperatures. For example, in a COLD wash selection, some warm water may be added to reach a temperature needed to better dissolve detergents. Often, detergents are not completely dissolved in very cold water, especially in cooler climates.

During winter months, when the water entering your home is colder, or for locations with very cold water year round, use the PerfectTemp plus COLD to help dissolve powdered detergents and to improve the cleaning of your clothes.

The TAP COLD feature turns the PerfectTemp feature on your washer off and uses your household tap water temperature for a COLD wash. This can provide energy savings by reducing the amount of hot water used in your wash.

### C. Options

- Autosoak Option (on some models)
  - This option begins with a brief agitation, soaks for a specified period of time, then moves through the rest of the cycle automatically. On some models, this option is located on the Cycle Selector knob.
- 2nd Rinse Option (on some models)
  - When you use extra detergent or bleach to clean heavily soiled clothes, you may want to use the 2nd Rinse option. It provides a second deep cold rinse.
- Extended Spin Option (on some models)
  - Use this option to extract more water from your clothes. Clothes will be drier when this option is selected and will dry more quickly in your dryer.
- Fabric Softener
  - Set this option when adding fabric softener to the washer.

**NOTE:** Do not use fabric softener dispensing balls with this washer. They do not work correctly in high-efficiency washers.

### D. Status Indicator Lights

The Cycle Indicator Lights show what stage the washer is in. When the Selector knob is set to a new cycle, the Indicator Lights will flash momentarily, showing what stages the cycle will go through. On models without an AUTO SOAK option, the SOAK light will not light up



### E. Wash Cycle—Cycle Selector Knob

The wash cycle controls the length and intensity of the washing process. The knob can be turned in either direction. Turning the Cycle Selector knob after starting a cycle will stop the washer and reset the cycle to the new selection. Press START to begin the new cycle selection.

The chart below will help you match the wash cycle setting with your clothing.

<b>COTTONS</b>	For heavy to lightly soiled cottons, household linens, work and play clothes. This cycle provides the best overall cleaning and should be used for most everyday items. Provides a high speed spin.
<b>PREWASH</b>	For removing surface dirt from heavily soiled clothes. Make sure to follow with a regular wash cycle.
<b>CASUALS</b>	For wrinkle-free and permanent press items and knits. Provides a low speed spin.
<b>EASY CARE</b>	For wrinkle-free and permanent press items and knits. Provides a high speed spin.
<b>DELICATES</b>	For lingerie and special-care fabrics with light soil. Provides a low speed spin.
<b>HAND WASH</b>	For items labeled handwashable with light soil. Provides an extra low speed spin.
<b>SPEED WASH</b>	For small loads of lightly soiled items that are needed in a hurry. Provides a high speed spin.
<b>DRAIN &amp; SPIN OR SPIN ONLY</b>	For draining the tub and spinning water out of the clothes. Provides a high speed spin.
<b>AUTO SOAK</b>	For very soiled clothes. Begins with a brief agitation, soaks for a specified period of time, then moves through the rest of the cycle automatically.

### F. START

Press START to begin the cycle. Pressing START again will PAUSE the cycle and the Cycle indicator light will blink.

To continue the cycle, press START again or close the lid. If machine is paused more than 24 hours, the cycle will be cancelled. To stop the cycle, hold the button for 3 seconds.

If water remains in the machine, select the DRAIN & SPIN OR SPIN ONLY cycle to drain tub and spin water out of the washer tub. Raising the lid will stop agitation or spin action but does not pause the cycle.

## About washer features

### The Fabric Softener Dispenser (on some models)

The fabric softener dispenser automatically releases liquid fabric softener at the proper time during the cycle.

Do not stop the washer during the first spin. This will cause the dispenser to empty too soon.

Never pour fabric softener directly on clothes. This may cause stains on your clothing.

To use, follow these steps:

1. Lift the tab on the fabric softener dispenser top.

2. Measure out fabric softener into the cap and pour the softener into the dispenser top. The fabric softener will drain into the receiving cup inside the dispenser. Use only “Ultra” or concentrated fabric softeners.

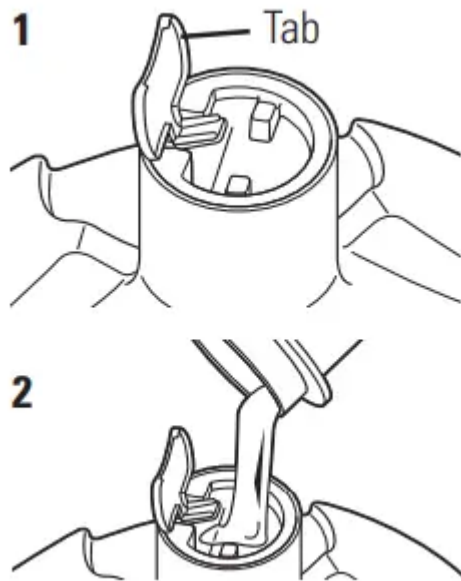

3. Push down on the tab to close the dispenser top. Make sure the tab is pushed down fully and snaps shut.

4. Select FABRIC SOFTENER from OPTIONS on the control panel.

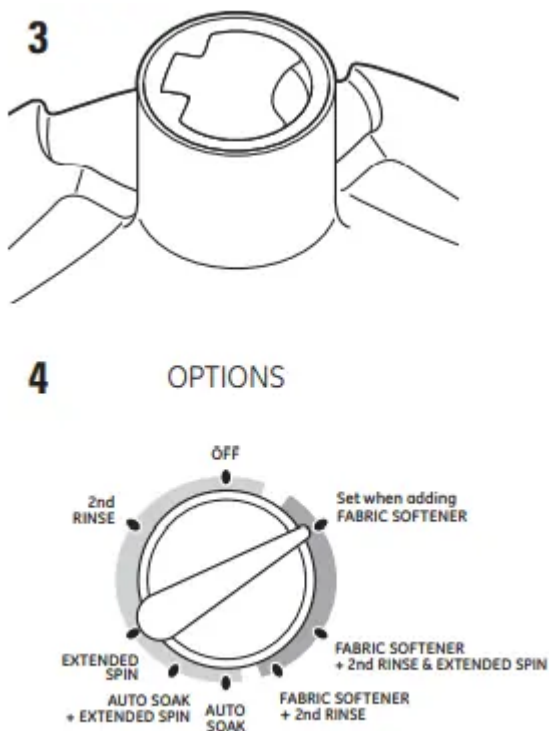

**NOTE:** Overfilling the dispenser will cause fabric softener to drain out of the holes in the side of the infusor when filling. Do not overfill.

### **Cleaning the Fabric Softener Dispenser (on some models)**

The Fabric Softener Dispenser is self cleaning. This dispenser does not require regular cleaning like standard fabric softener dispensers. Wipe down exterior surfaces of the dispenser as needed. If cleaning of the internal dispenser components is needed, follow these steps after the wash cycle is complete:

1. Lift the dispenser top tab and turn the top counterclockwise using the 2 turning tabs shown. Lift the dispenser out of the Infusor™.
2. Clean out any buildup from inside the Infusor™ with a soft cloth or toothbrush. Ensure the three rectangular holes in the bottom which allow the fabric softener to drain are not blocked.

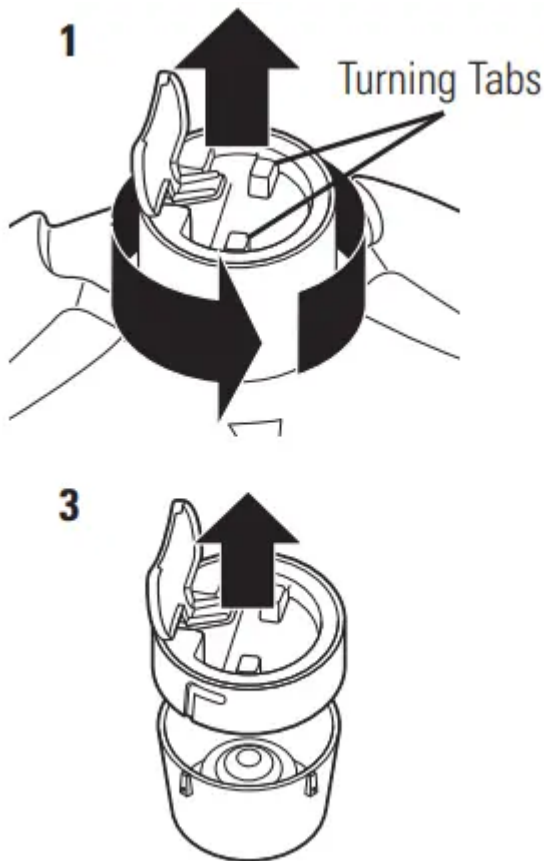

3. Gently pull the cap away from the dispenser cup to separate.
4. Wipe surfaces with a soft cloth or soak the parts in a solution of 1 gallon warm water, 1/4 cup liquid detergent and 1 cup bleach. Ensure the small hole in the top surface of the cap and associated tube are not obstructed.
5. Reassemble the dispenser cup and cap by snapping them together.

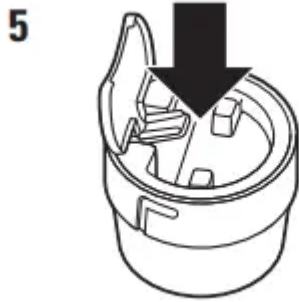

6. Place the dispenser assembly into the Infusor™. Turn the top clockwise using the 2 turning tabs shown. Push down on the tab to close the dispenser top. Make sure the tab is pushed down fully and snaps shut.

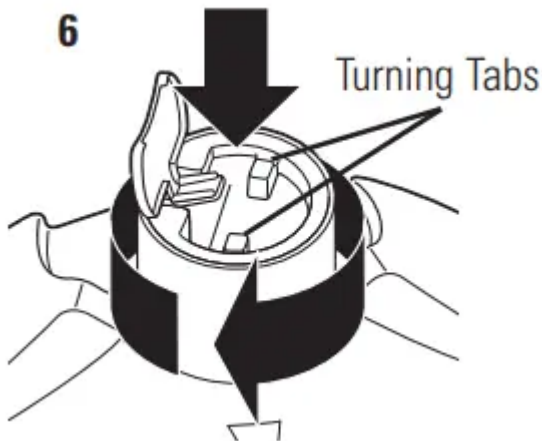

### Liquid Bleach Funnel

The water fill dilutes liquid chlorine bleach as the washer fills for the wash cycle.

1. Check clothing care labels for special instructions.
2. Measure liquid bleach carefully, following instructions on the bottle.
  - Never pour undiluted liquid chlorine bleach directly onto clothes or into the wash basket.
  - Do not pour powdered bleach into bleach funnel.
3. Before starting the washer, pour measured amount of bleach directly into bleach funnel. Avoid splashing or over-filling dispenser. If you prefer to use powdered bleach, add it into the wash basket with your detergent.
  - Do not mix chlorine bleach with ammonia or acids such as vinegar and/or rust remover. Mixing can produce a toxic gas which may cause death.



### Loading and using the washer

Always follow fabric manufacturer's care label when laundering.

#### Sorting Wash Loads



Sort by color (whites, lights, colors), soil level, fabric type (sturdy cottons, easy care, delicates) and whether the fabric produces lint (terry cloth, chenille) or collects lint (velveteen, corduroy).

#### Proper Use of Detergent

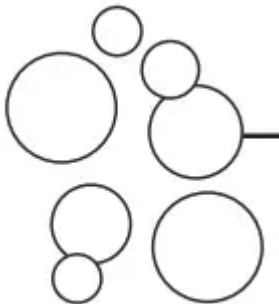

Add detergent and fabric softener before adding clothes so that the detergent can work effectively. Using too little or too much detergent is a common cause of laundry problems.

Use less detergent if you have soft water, a smaller load or a lightly soiled load.

GE recommends the use of High Efficiency  detergents in all Energy Star rated washers. HE detergents are formulated to work with low water wash and rinse systems. HE detergents reduce the oversudsing problems commonly associated with regular detergents.

### Loading the Washer



Load dry items loosely, no higher than the top row of holes in the washer basket. For best results, load items evenly and loosely around the outside of the basket. To add items after washer has started, lift the lid and submerge additional items around the outside of the basket.

- Do not place large items such as sheets, blankets and towels across the Infusor™. Load them around the outside of the basket.
- Do not wash fabrics containing flammable materials (waxes, cleaning fluids, etc.).
- Agitation will not start with the lid up.

### Care and cleaning of the washer



**Wash Basket:** Leave the lid open after washing to allow moisture to evaporate. If you want to clean the basket, use a clean, soft cloth dampened with liquid detergent; then rinse. (Do not use harsh or gritty cleaners.)

**Fill Hoses:** GE recommends changing the hoses every 5 years.

**Exterior:** Immediately wipe off any spills. Wipe with damp cloth. Try not to hit surface with sharp objects.

**Interior:** The occasional use of a cycle that contains bleach will keep the inside of the washer clean.



Moving and Storage: Ask the service technician to remove water from drain pump and hoses. See the Installation Instructions packed with product for information on how to reinstall the shipping rod to keep the tub stationary when moving the washer. For more information, visit [ge.com](http://ge.com) or call 800.GE.CARES (800.432.2737). Do not store the washer where it will be exposed to the weather.

Long Vacations: Be sure water supply is shut off at faucets. Drain all water from hoses if weather will be below freezing.



# Troubleshooting



WATER	Possible Causes	What To Do
Water level seems low	This is normal	Water may not cover the top level of the clothes. This is normal for this high-efficiency washer.
Water fills and drains at the same time	Drain stand pipe is too low	The drain stand pipe must be above 30".
Too many suds	<ul style="list-style-type: none"> <li>• Too much detergent</li> <li>• Type of detergent</li> <li>• Soft water</li> </ul>	<ul style="list-style-type: none"> <li>• Measure your detergent carefully. Use less soap if you have soft water, a smaller load or a lightly soiled load.</li> <li>• Switch to HE  detergent.</li> <li>• Try less detergent.</li> </ul>
Water leaks	<ul style="list-style-type: none"> <li>• Using too much detergent in washer</li> <li>• Type of detergent</li> <li>• Fill hoses or drain hose is improperly connected</li> <li>• Household drain may be clogged</li> <li>• Constant water pressure to the fill hoses at the water source</li> </ul>	<ul style="list-style-type: none"> <li>• Use less detergent. Use less soap if you have soft water, a smaller load or a lightly soiled load.</li> <li>• Switch to HE  detergent.</li> <li>• Make sure hose connections are tight at faucets and rubber washers are installed. Make sure end of drain hose is correctly inserted in and secured to drain facility.</li> <li>• Check household plumbing. You may need to call a plumber.</li> <li>• Tighten hoses at the faucets and turn the water off after each use.</li> <li>• Check condition of the fill hoses; they should be replaced every 5 years.</li> </ul>
Water temperature seems incorrect	<ul style="list-style-type: none"> <li>• Cooler water temperatures provide improved energy efficiency</li> </ul>	<ul style="list-style-type: none"> <li>• New laundry detergents have been formulated to work with cooler water temperatures without affecting wash performance</li> </ul>

	<ul style="list-style-type: none"> <li>• Water supply is turned off or improperly connected</li> <li>• Water valve screens are stopped up</li> <li>• House water heater is not set properly</li> </ul>	<ul style="list-style-type: none"> <li>• Turn both hot and cold faucets fully on and make sure hoses are connected to correct faucets.</li> <li>• Turn off the water source and remove the water connection hoses from the upper back of the washer. Use a brush or toothpick to clean the screens in the machine. Reconnect the hoses and turn the water back on.</li> <li>• Make sure house water heater is delivering water at 120°F–140°F (48°C–60°C).</li> </ul>
Water pumped out before cycle is complete	Lid lifted or cycle was put in pause for over 24 hours	Reset cycle.
Water won't drain	Drain hose is kinked or improperly connected	<ul style="list-style-type: none"> <li>• Straighten drain hose and make sure washer is not sitting on it.</li> <li>• Top of drain outlet should be less than 6 ft (1.8 m) above floor.</li> </ul>
Washer pauses during wash cycle	The PREWASH Cycle or AUTO SOAK Option was chosen	This is normal. The washer alternates between agitate and soak during these cycles to get your clothes cleaner with less wear.
Washer pauses during spin cycle	This is normal	The washer may pause during the spin cycle to remove soapy water more efficiently.

<p>Washer won't operate</p>	<ul style="list-style-type: none"> <li>• Washer is unplugged</li> <li>• Water supply is turned off</li> <li>• Controls are not set properly</li> <li>• Lid is open—safety feature prevents agitation and spinning when lid is up</li> <li>• Circuit breaker/fuse is tripped/blown</li> <li>• Electronics need to be reset</li> <li>• START was not pressed</li> <li>• Lid magnet missing</li> </ul>	<ul style="list-style-type: none"> <li>• Make sure cord is plugged securely into a working outlet.</li> <li>• Turn both hot and cold faucets fully on.</li> <li>• Check controls.</li> <li>• Close lid and reset cycle, to the beginning if necessary.</li> <li>• Check house circuit breakers/fuses. Replace fuses or reset breaker. Washer should have a separate outlet.</li> <li>• Unplug washer, wait 2 minutes, plug back in and press START.</li> <li>• Press START.</li> <li>• Call for service.</li> </ul>
<p>Time not shown on display</p>	<p>Unit filling</p>	<p>This is normal. Estimated time remaining is updated during fill time.</p>
<p>Movement inside machine when shut off</p>	<p>Shifting mechanism is disengaging the motor</p>	<p>When the machine is manually turned off, the shifter will disengage the motor before completely shutting down. If lid is raised before the motor is disengaged, it will resume when lid is closed.</p>
<p>Clothes too wet</p>	<ul style="list-style-type: none"> <li>• Incorrect cycle selected.</li> </ul>	<ul style="list-style-type: none"> <li>• Make sure the cycle selected matches the load you are washing. Some fabrics will feel wetter when rinsed with cold water</li> </ul>



	<ul style="list-style-type: none"> <li>• Wash load out of balance</li> </ul>	<ul style="list-style-type: none"> <li>• Redistribute load in washer and run through Drain &amp; Spin cycle</li> </ul>
Colored spots	<ul style="list-style-type: none"> <li>• Incorrect use of fabric softener</li> <li>• Dye transfer</li> </ul>	<ul style="list-style-type: none"> <li>• Check fabric softener package for instructions and follow directions for using dispenser.</li> <li>• Make sure you have selected the Fabric Softener option.</li> <li>• Pretreat stain and rewash.</li> <li>• Sort whites or lightly colored items from dark colors.</li> </ul>
Grayed or yellowed clothes	<ul style="list-style-type: none"> <li>• Detergent amount</li> <li>• Hard water</li> <li>• Water is not hot enough</li> <li>• Washer is overloaded</li> <li>• Detergent is not dissolving</li> <li>• Dye transfer</li> </ul>	<ul style="list-style-type: none"> <li>• Be sure to follow detergent manufacturer's directions.</li> <li>• Use a water conditioner like Calgon brand or install a water softener.</li> <li>• Make sure water heater is delivering water at 120°F–140°F (48°C–60°C).</li> <li>• Loosely load clothes no higher than the top row of holes in the washer basket. For best results, load items around the outside of the basket.</li> <li>• Add detergent to the wash basket before you load clothes.</li> <li>• Sort clothes by color. If fabric label states wash separately, unstable dyes may be indicated.</li> </ul>
Lint or residue on clothes	<ul style="list-style-type: none"> <li>• Clothes are air or line dried</li> <li>• Incorrect sorting</li> <li>• Washing too long</li> <li>• Detergent not dissolving</li> </ul>	<ul style="list-style-type: none"> <li>• If you do not dry your clothes with a clothes dryer, your clothes may retain more lint.</li> <li>• Separate lint producers from lint collectors.</li> <li>• Wash small loads for a shorter time than larger loads.</li> <li>• Add detergent to wash basket before you load clothes.</li> </ul>

	<ul style="list-style-type: none"> <li>• Overloading</li> <li>• Incorrect use of fabric softener</li> </ul>	<ul style="list-style-type: none"> <li>• Try a liquid detergent.</li> <li>• Use warmer water temperature.</li> <li>• Loosely load clothes no higher than the top row of holes in the washer basket. For best results, load items around the outside of the basket.</li> <li>• Check fabric softener package for instructions and follow directions for using dispenser.</li> </ul>
Pilling	Result of normal wear on poly-cotton blends and fuzzy fabrics	While this is not caused by the washer, you can slow the pilling process by washing garments inside out.
Snags, holes, tears, rips or excessive wear	<ul style="list-style-type: none"> <li>• Pins, snaps, hooks, sharp buttons, belt buckles, zippers and sharp objects left in pockets</li> <li>• Undiluted chlorine bleach</li> <li>• Chemicals like hair bleach or dye, permanent wave solution</li> </ul>	<ul style="list-style-type: none"> <li>• Fasten snaps, hooks, buttons and zippers.</li> <li>• Remove loose items like pins, objects in pockets and sharp buttons.</li> <li>• Turn knits (which snag easily) inside out.</li> <li>• Check bleach package instructions for proper amount.</li> <li>• Never add undiluted bleach to wash or allow clothes to come in contact with undiluted bleach.</li> <li>• Rinse items that may have chemicals on them before washing</li> </ul>
Wrinkling	<ul style="list-style-type: none"> <li>• Improper sorting</li> <li>• Overloading or incorrect water level</li> <li>• Incorrect wash and dry cycles</li> </ul>	<ul style="list-style-type: none"> <li>• Avoid mixing heavy items (like work clothes) with light items (like blouses).</li> <li>• Try a fabric softener</li> <li>• Load clothes no higher than the top row of holes in the washer basket.</li> <li>• Match Cycle selection to the type of fabric you are washing (especially for easy care loads).</li> </ul>

• Repeated washing in water that is too hot

• Wash in warm or cold water.



<b>SOUNDS</b>	<b>Possible Causes</b>	<b>What To Do</b>
“Metallic clicking”	Shifter mechanism is engaging or disengaging	The drive system will engage at the start of agitate and disengage when agitate is complete. This occurs multiple times during the wash.
Back and forth “swoosh” or light “clicking” sound during agitate	Electric motor reversing direction	This machine has a drive system that doesn’t use gears. This sound is the motor rotating back and forth to clean your laundry.
Quick short agitation sounds at end of agitate	Clothing redistribution	At the end of agitate, the motor makes short agitation strokes to redistribute the load
“Click” when water stops filling	Relay switch	The relay makes a click sound when activated. The water level activates the relay and stops filling.
“Clicking” behind Control Panel during fill	Automatic Temperature Control Valve	This valve mixes in cold and hot water. The “clicking” is the valve turning on and off
Water volume changes during fill	Automatic Temperature Control Valve	This valve mixes in cold and hot water. The sound changes when the valves are turned on and off.
Motor “whining up” or “coasting down” in spin	Motor ramping up/down during spin cycle	The motor will speed up incrementally during the spin cycle. When spin is complete, it will coast until it stops.
“Humming”	Water drain pump	The drain pump will make a humming sound when pumping out water after agitation stops and continue until spin is complete.
“Gurgling”	Water drain pump	When the pump starts drawing in air, It starts to gurgle. The washer should then begin spinning and the sound will continue until it is done spinning.



Water "swishing"	This is normal	This washer uses a Infusor™ wash action. Water swishing while the unit is agitating is normal, especially with smaller loads.
Washer is noisy	<ul style="list-style-type: none"> <li>• Washer is uneven</li> <li>• Shipping rod is still assembled in the unit</li> </ul>	<ul style="list-style-type: none"> <li>• To level the front of the washer, adjust the front leveling legs by rotating the individual leg in the proper direction for up or down. To level the back of the washer, lift the back of the machine 4" (11 cm) and set down.</li> <li>• To remove the shipping rod from the washer, pull the yellow tag and attached rod from the bottom right hand side of the washer</li> </ul>

**Warning**

This content is compiled from multiple sources and is provided for reference purposes only. It may not be complete or fully applicable to all situations. If you are unable to resolve your issue, please contact the product manufacturer or an authorized service provider for official support.

