

Operations

Feature panel

WF45M5500A*

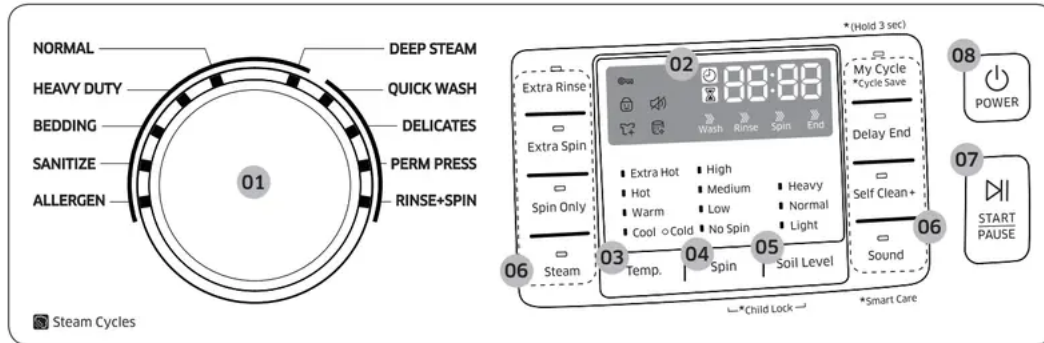

WF45M5100A*

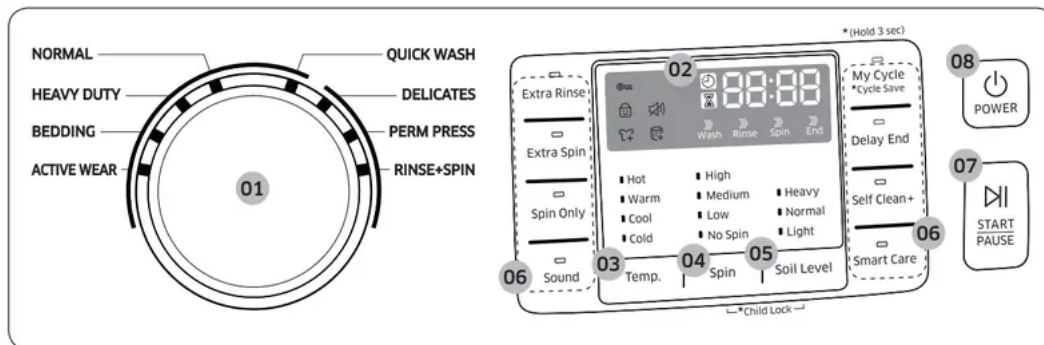

<p>01 Cycle Selector</p>	<p>Turn the dial to select a cycle.</p>
<p>02 Display</p>	<p>The display shows current cycle information and estimated time remaining, or an information code if the washer needs to be checked.</p>
<p>03 Temp.</p>	<p>Press to change the water temperature for the current cycle.</p> <p>WF45M5500A*</p> <ul style="list-style-type: none"> • Extra Hot: Heavily soiled, colorfast items. Only available with NORMAL, HEAVY DUTY, and SANITIZE.



	<ul style="list-style-type: none"> • Hot: Whites and heavily soiled, colorfast items. • Warm: Uses warm water only in the final rinse process. This is for energy saving purposes. • Cool: Brightly colored, very lightly soiled items. The washer supplies additional hot water or drives the heater to warm up the water if it is below 60 °F (16 °C). • Cold: Uses only cold water without driving the heater. No warm water is supplied. <p>WF45M5100A*</p> <ul style="list-style-type: none"> • Hot: Whites and heavily soiled, colorfast items. • Warm: Uses warm water only in the final rinse process. This is for energy saving purposes. • Cool: Brightly colored, very lightly soiled items. The washer supplies additional hot water or drives the heater to warm up the water if it is below 60 °F (16 °C). • Cold: Uses only cold water without driving the heater. No warm water is supplied.
<p>04 Spin</p>	<p>Press to change the spinning speed for the current cycle.</p> <ul style="list-style-type: none"> • High: Underwear, t-shirts, jeans and sturdy cottons. • Medium: Jeans, wrinkle-free or wash-and-wear items and synthetics. • Low: Delicate items that requires a lower spinning speed. • No Spin: The drum does not spin after the final drain process. • Rinse Hold (No lamp turns on): The final rinse process is suspended so that the laundry remains in the water. To unload the laundry, run a drain or spin process. <p>NOTE</p>



	<p>Spin Only: This cycle runs the spinning process. With the cycle time on the display, press Spin repeatedly until a desired spinning speed is selected. Then, press START/PAUSE to start the cycle. This cycle is available only when no specific cycle is selected.</p>
<p>05 Soil Level</p>	<p>Press the button to select the soil level/washing time.</p> <ul style="list-style-type: none"> • Heavy: For heavily soiled loads. • Normal: For moderately soiled loads. This setting is best for most loads. • Light: For lightly soiled loads.
<p>06 Options</p>	<p>Press the buttons to select different cycle options.</p>
<p>07 START/PAUSE</p>	<p>Press to Start or Pause operation.</p>
<p>08 POWER</p>	<p>Press to turn the washer on or off.</p>

WF45M5500A*

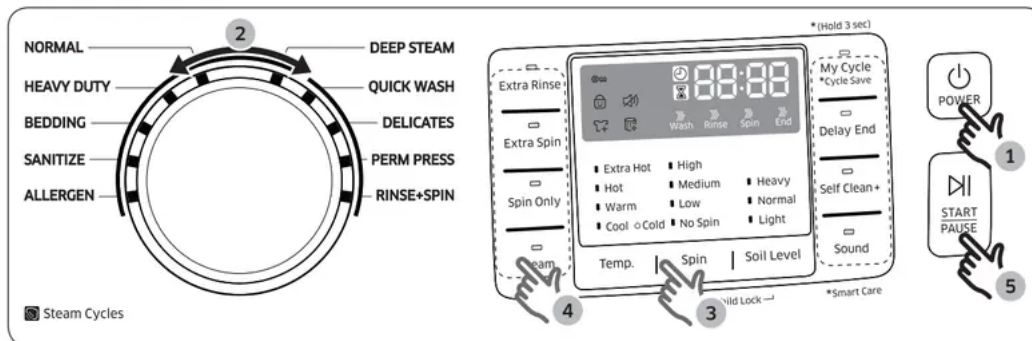

WF45M5100A*

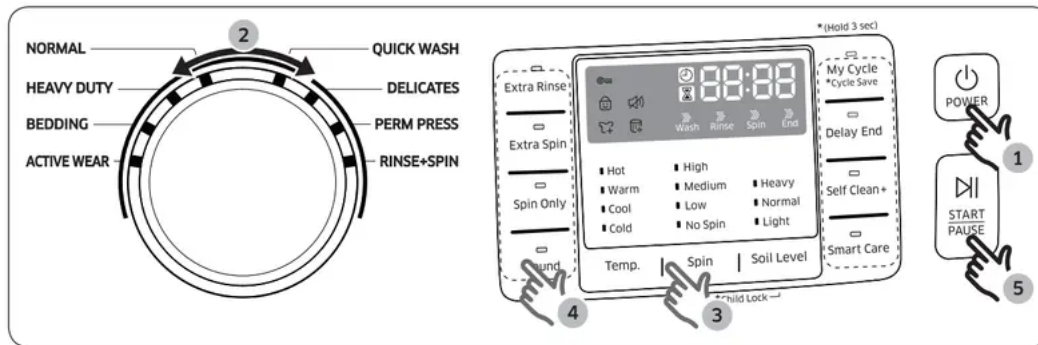

1. Press POWER to turn on the washer.
2. Turn the Cycle Selector to select a cycle.
3. Change the cycle settings (Temp., Spin, and Soil Level) as necessary.
4. Select desired options as necessary.
5. Press START/PAUSE.

To change the cycle during operation

1. Press START/PAUSE to stop operation.
2. Select a different cycle.
3. Press START/PAUSE again to start the new cycle.

RINSE+SPIN	<ul style="list-style-type: none"> • Features an additional rinse process after fabric softener is applied to the laundry.
ACTIVE WEAR (WF45M5100* model only)	<ul style="list-style-type: none"> • For exercise wear such as sports jerseys, training pants, shirts/tops and other performance clothing. This cycle provides effective soil removal with controlled drum rotation for special fabric care.

Cycle overview

Standard cycles

Cycle	Description
QUICK WASH	<ul style="list-style-type: none"> • For lightly soiled items that you want to finish washing quickly.
DELICATES	<ul style="list-style-type: none"> • For sheer fabrics, bras, lingerie (silk), and other handwash only fabrics. • For best performance, use liquid detergent.
PERM PRESS	<ul style="list-style-type: none"> • For wash-and-wear, synthetic fabrics, and lightly to normally soiled items.
RINSE+SPIN	<ul style="list-style-type: none"> • Features an additional rinse process after fabric softener is applied to the laundry.
ACTIVE WEAR (WF45M5100* model only)	<ul style="list-style-type: none"> • For exercise wear such as sports jerseys, training pants, shirts/tops and other performance clothing. This cycle provides effective soil removal with controlled drum rotation for special fabric care.

Steam cycles

DEEP STEAM (WF45M5500A* model only)	<ul style="list-style-type: none"> • For heavily soiled, colorfast items. This cycle uses steam and a high water temperature to effectively remove stains.
NORMAL	<ul style="list-style-type: none"> • For cottons, bed linens, table linens, underwear, towels, or shirts. The washing time and the number of rinses are automatically adjusted according to the load.
HEAVY DUTY	<ul style="list-style-type: none"> • For sturdy, colorfast fabrics and heavily soiled items.
BEDDING	<ul style="list-style-type: none"> • For bulky items such as comforters, blankets, and sheets. • For best results, wash only 1 type of bedding. • For bulky items, use liquid detergent and do not roll the items in the drum because they might get stuck in the drum.
SANITIZE (WF45M5500A* model only)	<ul style="list-style-type: none"> • For heavily soiled, colorfast items. This cycle heats the water to 150 °F to eliminate bacteria. <p style="text-align: center;">NOTE</p> <p>If you press START/PAUSE during the heating portion of SANITIZE cycle, your washer door will remain locked for your safety.</p>
ALLERGEN (WF45M5500A* model only)	<ul style="list-style-type: none"> • Use to remove dust mites, pet dander, or other allergic substances.

Cycle	Description
DEEP STEAM (WF45M5500A* model only)	<ul style="list-style-type: none"> • For heavily soiled, colorfast items. This cycle uses steam and a high water temperature to effectively remove stains.
NORMAL	<ul style="list-style-type: none"> • For cottons, bed linens, table linens, underwear, towels, or shirts. The washing time

Options

Option	Description
Extra Rinse	<ul style="list-style-type: none"> • Adds an additional rinse at the end of the cycle to remove laundry additives more thoroughly.
Extra Spin	<ul style="list-style-type: none"> • Adds additional spin time to remove more water from loads.
Spin Only	<ul style="list-style-type: none"> • Press to run the Spin cycle of a selected course only.
Steam	<ul style="list-style-type: none"> • Press this button to use the Steam function. Steam is available with the NORMAL, HEAVY DUTY, BEDDING, SANITIZE, DEEP STEAM and ALLERGEN. For heavily soiled, colorfast items, the Steam function improves stain treatment and uses less water. (only for WF45M5500A* model)
Sound	<ul style="list-style-type: none"> • Press to mute the washer. No alarm or melody will sound except for the diagnostic checking beep and the indicator “” lights up. To unmute, press the button again.
My Cycle	<ul style="list-style-type: none"> • Create your own washing cycle with preferred settings and use the cycle with a single button push.
Delay End	<ul style="list-style-type: none"> • Set the washer to finish your wash automatically at a later time. Choose a delay of between 1 to 24 hours (in 1 hour increments).
Self Clean+	<ul style="list-style-type: none"> • Cleans the drum by removing dirt and bacteria from the drum. • Perform once every 40 washes.

	<ul style="list-style-type: none"> • Make sure the drum is empty.
Smart Care	<ul style="list-style-type: none"> • This function enables you to check the status of the washing machine using a smartphone.

Delay End

You can set the washer to finish your wash automatically at a later time by choosing a delay of between 1 to 24 hours (in 1 hour increments). The hour displayed indicates the time the wash will finish.

1. Select a cycle. Then, change the cycle settings if necessary.
2. Press Delay End repeatedly until a desired end time is set.
3. Press START/PAUSE. The  indicator turns on with the clock running.
4. To cancel Delay End, restart the washer by pressing POWER.

Real-life case

You want to finish a two-hour cycle 3 hours from now. To do this, you add the Delay End option to the current cycle with a 3-hour setting, and then press START/PAUSE at 2:00 pm.

The washer starts operating at 3:00 pm and ends at 5:00 pm. Provided below is the time line for this example.

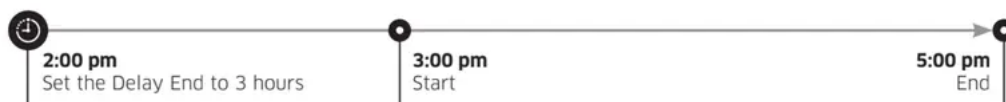

Steam

With the Steam cycle, the washer senses the weight of the load and controls the steam effect according to the load size. This improves washing performance.

Available Steam cycles are: NORMAL, HEAVY DUTY, BEDDING, SANITIZE, ALLERGEN, and DEEP STEAM.

1. Turn the Cycle Selector to select a Steam cycle.
2. Press Steam.
3. Add detergent and fabric softener as instructed.
4. Press START/PAUSE to start the cycle.

Child Lock

To prevent accidents by children or infants, Child Lock locks all buttons except for the Power button.

To activate Child Lock

- Press and hold both Soil Level and Spin for 3 seconds. Then, press START/PAUSE to activate. The door locks and the Child Lock indicator turns on.

To deactivate Child Lock temporarily

- You can deactivate Child Lock temporarily for 1 minute. To do this, press and hold both Soil Level and Spin for 3 seconds. The door is unlocked for 1 minute and the Child Lock indicator blinks.

NOTE

- If you open the door 1 minute after deactivating Child Lock, an alarm sounds for up to minutes.
- If you close the door within 2 minutes, the door locks and Child Lock is reactivated. If you do not close the door or the door is not properly closed, the alarm keeps sounding for 2 minutes.
- To add laundry after activating Child Lock, deactivate Child Lock or restart the washer.

To cancel Child Lock

- Press and hold both Soil Level and Spin for 6 seconds. The door unlocks and the Child Lock indicator turns off.

My Cycle

Create your own washing cycle with preferred settings and use the cycle with the push of a single button.

To create your own cycle

1. Turn the Cycle Selector to select a cycle.
2. Change the cycle settings (Temp., Spin, and Soil Level) as necessary.
3. Add an option to your preference. For more information, see the “Options” section.
4. Press and hold My Cycle for 3 seconds to save your settings. Applicable indicators blink for 3 seconds. Once you save the cycle, you can use it by pressing My Cycle.

NOTE

If you press and release My Cycle within 3 seconds, the previously saved cycle and options appear.

Sound

Mute or unmute the sound.

- The Sound Off function can be selected during all cycles.

WF5500M_DC68-03773A-05_EN.indd 41 3/15/2019 4:54:50 PM

ATC (Auto Temperature Control)

ATC enables the washer to control water temperatures in each washing cycle using the internal thermistor. It is designed to maintain certain washing temperatures for best results.

NOTE

- If you select NORMAL or HEAVY DUTY, you may notice the washer supplying cold water. This is normal because the machine is designed to reduce power consumption.
- In these cycles, the Hot temperature is similar to bath-water temperatures, and the Warm temperature to comfortable swimming pool temperatures.
- To wash clothes at a specific temperature, you must choose a different cycle first.

Maintenance

Keep the washer clean to prevent its performance from deteriorating and to preserve it throughout its life cycle.

Self Clean+

Certain usage and environmental conditions may result in some residue build-up or odor in the washer drum. To prevent this build-up of residue or odor causing bacteria and keep your washer drum fresh and clean, perform the Self Clean+ cycle at least once a month or every 40 cycles.

Perform the recommended procedure below when using the Self Clean+ cycle.

1. Remove all items from the washer drum and ensure the drum is empty. Laundry left in the drum during the Self Clean+ cycle may be damaged.
2. Press POWER to turn on the washer.
3. Press Self Clean+.
4. Press START/PAUSE.

Self Clean+ reminder ()

- After 40 washing cycles, the Self Clean+ LED reminder icon and the Self Clean+ cycle LED will blink on the control panel for an hour and then turn off automatically.
- The reminder will appear on the control panel for 5 additional consecutive cycles before turning off. The next reminder will not appear until another 40 cycles have been completed.

Smart Care

The Smart Care function helps you diagnose and troubleshoot your washer if it has a problem. To enable this function, you must first download the Samsung Smart Washer app from the Play Store or the Apple Store, and install it on a mobile device that has a camera.

The Smart Washer Smart Care function has been optimized for: Galaxy and iPhone series devices. (It is not supported by some models.)

As the washer operates, it runs its self-diagnosis function in the background. If it senses a problem, it displays an information code on the display which you can scan using the app's Smart Care function. The Smart Care function will then display detailed information about the code.

1. To enable the Smart Care function.

- Press and hold Sound on the washer for 3 seconds to enter the Smart Care mode. (only for WF45M5500A* model)
- Press Smart Care button to enter the Smart Care mode. (only for WF45M5100A* model)

2. Run the Samsung Smart Washer app on your mobile device, and tap Smart Care.

3. Hold the mobile device so that the mobile device and the washer's display panel face each other. The app will recognize the information code automatically.

4. When the information code is recognized correctly, the app provides detailed information about the symptom and recommends further action.

Emergency drain

In case of a power failure, drain the water inside the drum before taking out the laundry.

1. Power off the washer, and then unplug it from the electrical outlet.
2. Gently press the top area of the filter cover to open.

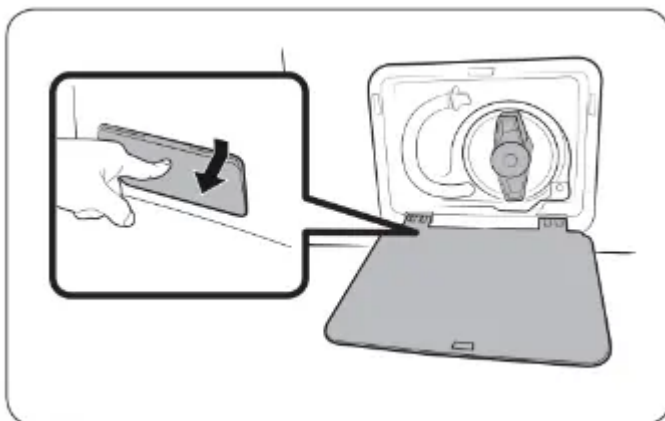

3. Put an empty, spacious container around the cover, and stretch the emergency drain tube to the container while holding the tube cap (A).

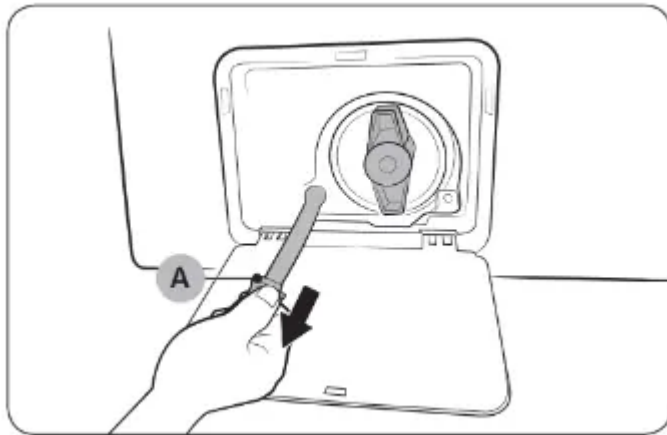

4. Open the tube cap and let water in the Emergency drain tube (B) flow into the container.

5. When done, close the tube cap, and reinsert the tube. Then, close the filter cover.

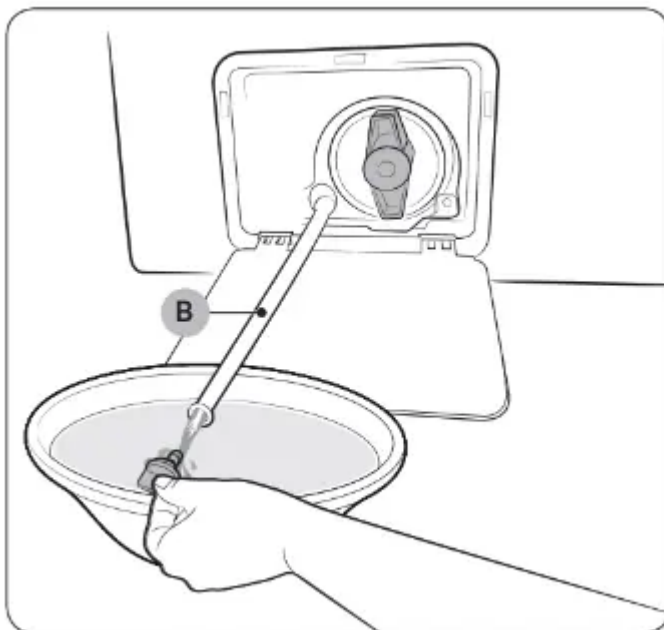

NOTE

Use a spacious container because the water in the drum may be more than expected.

Cleaning

Surface of the washer

Use a soft cloth with a nonabrasive household detergent. Do not spray water onto the washer.

Mesh filter

Clean the mesh filter of the water hose once or twice a year.

1. Turn off the washer, and then unplug the power cord.
2. Close the faucet.
3. Loosen and disconnect the water hose from the back of the washer. Cover the hose with a cloth to prevent water from gushing out.

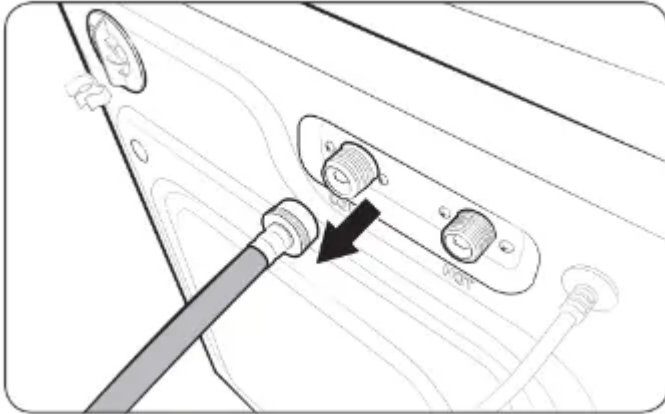

4. Use pliers to pull out the mesh filter from the inlet valve.
5. Submerge the mesh filter deeply in water so that the threaded connector is also submerged.
6. Dry the mesh filter completely in a shaded area.
7. Reinsert the mesh filter into the inlet valve, and reconnect the water hose to the inlet valve.
8. Open the faucet.

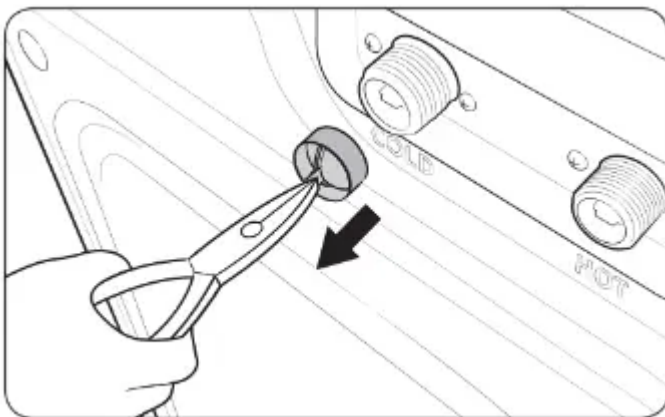

NOTE

If the mesh filter is clogged, the "4C" information code appears on the the washer's display screen

Pump filter

It is advisable to clean the pump filter 5 or 6 times a year to prevent its clogging. A clogged pump filter may reduce the bubble effect.

1. Turn off the washer, and unplug the power cord.
2. Drain the remaining water inside the drum. See the “Emergency drain” section on page 45.
3. Gently press the top area of the filter cover to open.
4. Turn the pump filter knob (A) to the left, and drain off the remaining water.

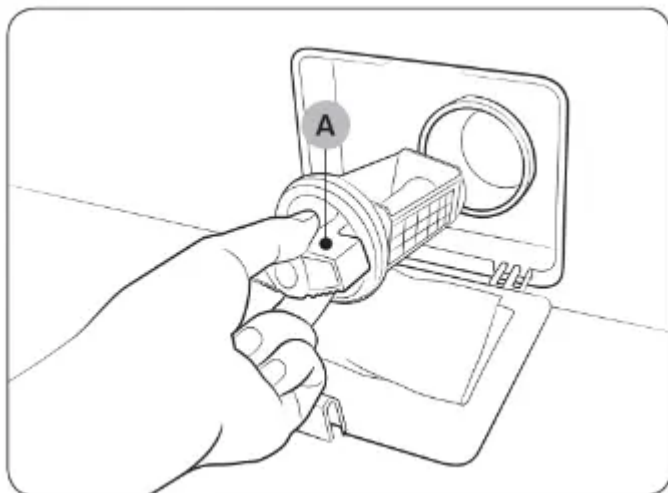

5. Clean the pump filter using a soft brush. Make sure the drain pump propeller inside the filter is not clogged.
6. Reinsert the pump filter, and then turn the filter knob to the right.
7. Close the filter cover.

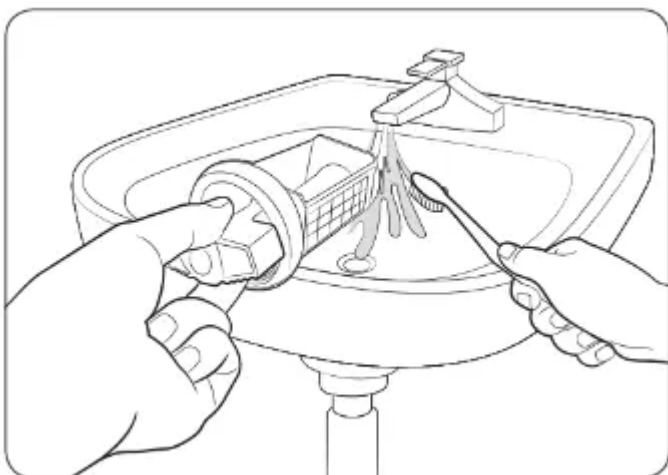

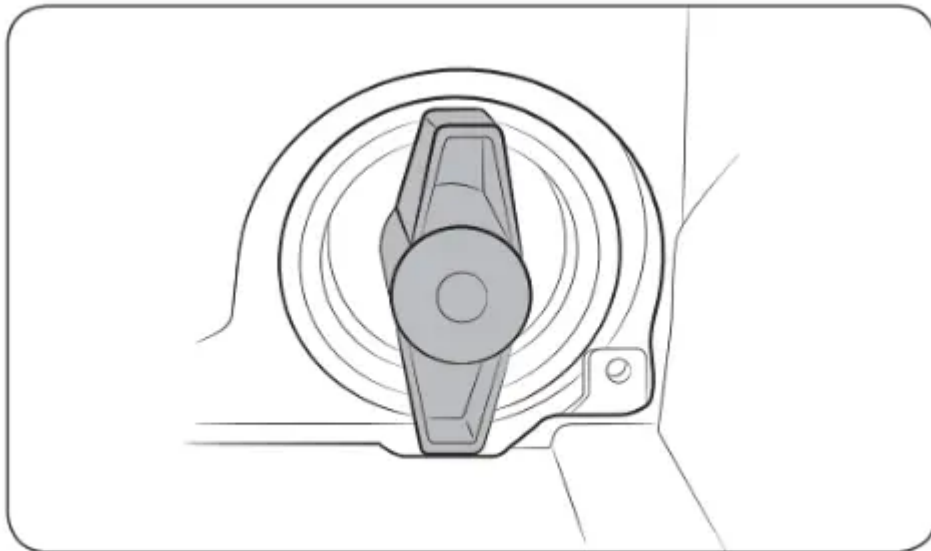

NOTE

- Some pump filters feature a safety knob that is designed to prevent children from accidentally opening the filter compartment. To open the safety knob of the pump filter, push in and turn it counterclockwise. The spring mechanism of the safety knob helps open the filter.
- To close the safety knob of the pump filter, turn it clockwise. The spring makes a rattling sound, which is normal.

NOTE

If the pump filter is clogged, the “5C” information code appears on the washer’s display screen.

Detergent drawer

1. While holding down the release lever (A) inside the drawer, slide open the drawer, and then remove the drawer from the washer.
2. Remove the liquid detergent container from the drawer.

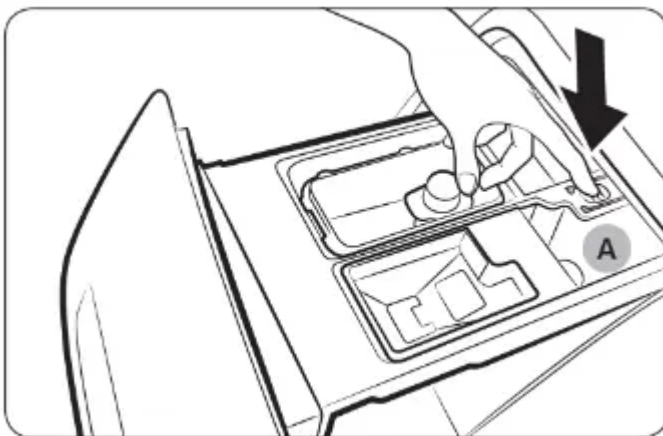

3. Clean the drawer components in flowing water using a soft brush.

NOTE

Other parts of the drawer can also be removed. They can fall out if you hold the drawer upside down.

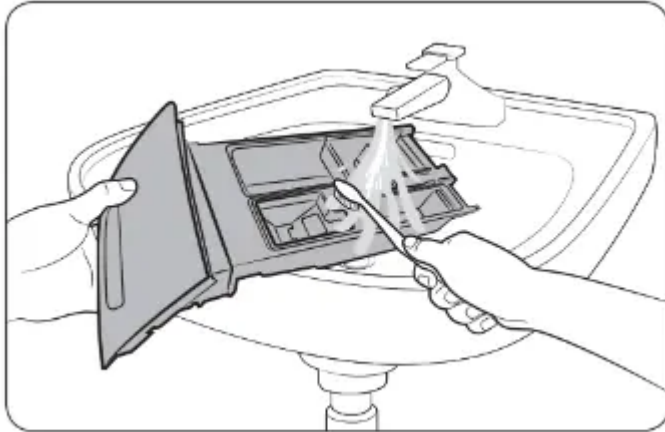

4. Clean the drawer recess using a soft brush.

5. Reinsert the liquid detergent container into the detergent drawer.

6. Slide the drawer into the drawer recess, and then push it inward until it is fully closed.

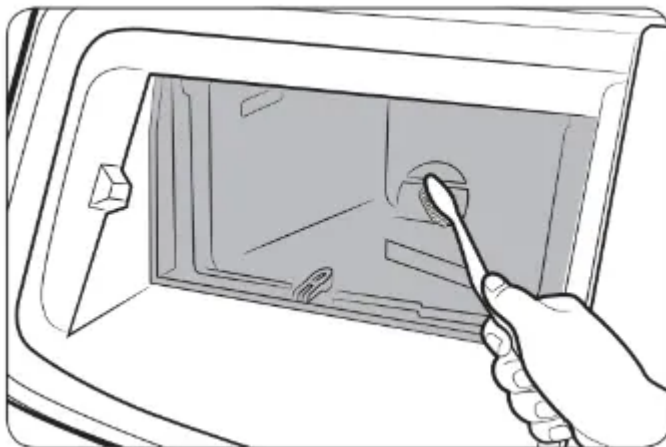

NOTE

To remove remaining detergent, run a RINSE+SPIN cycle with the drum empty.

Door diaphragm

1. Open the door, and then empty the drum.
2. Combine 3/4 cups of liquid chlorine bleach and 1 gallon of warm tap water.
3. Turn over the diaphragm (A).



4. Wearing rubber gloves, use a soft, clean cloth dipped in the water and bleach solution to clean the diaphragm.
5. Let stand 5 minutes, and then wipe up and dry well.
6. Put the diaphragm back into position.

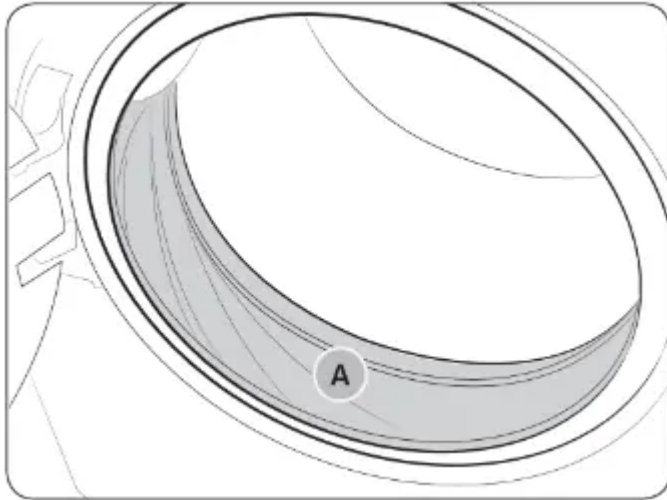

CAUTION

Use bleach carefully and be sure to follow the bleach manufacturer's use and care instructions.

Recovery from freezing

The washer may freeze when the temperature in its location drops below 32 °F (0 °C).

1. Turn off the washer, and unplug the power cord.
2. Pour warm water over the faucet to loosen the water hose.
3. Disconnect the water hose, and soak it in warm water.
4. Pour warm water into the drum and leave it for about 10 minutes.
5. Reconnect the water hose to the faucet.

NOTE

If the washer still doesn't operate normally, repeat the steps above until it operates normally.

Care against an extended time of disuse

Avoid leaving the washer unused for an extended time. However, if you intend to leave the washer unused for a long period of time, follow the directions below:

1. Press the POWER button, and then turn the Cycle Selector to RINSE+SPIN.
2. Empty the drum, and then press START/PAUSE.
3. When the cycle is complete, close the faucets and disconnect the water hoses.

4. Turn off the washer, and then unplug the power cord.
5. Open the door to let air circulate through the drum.

Cleaning the exterior

1. Turn off the water faucets after finishing the day's washing.

This will shut off the water supply to your washer and prevent the unlikely possibility of damage from escaping water. Leave the door open to allow the inside of your washer to dry out.

2. Use a soft cloth to wipe up all detergent, bleach, or other spills as they occur. Clean the following as recommended below:

- **Control Panel** – Clean with a soft, damp cloth. Do not use abrasive powders or cleaning pads. Do not spray cleaners directly on the panel.
- **Cabinet** – Clean with soap and water.

Cleaning the interior

Clean the interior of your washer periodically to remove any dirt, soil, odor, mold, mildew, or bacterial residue that may remain in your washer as a result of washing clothes.

Troubleshooting

Checkpoints

If you encounter a problem with the washer, first check the table below and try the suggestions.

Problem	Action
Does not start.	<ul style="list-style-type: none"> • Make sure the washer is plugged in. • Make sure the door is properly closed. • Make sure the faucets are open. • Make sure to press or tap START/PAUSE to start the washer. • Make sure Child Lock is not activated. • Before the washer starts to fill, it will make a series of clicking noises to check the door lock and does a quick drain. • Check the fuse or reset the circuit breaker.



<p>Water supply is insufficient, or no water is supplied.</p>	<ul style="list-style-type: none"> • Fully open the faucet. • Make sure the door is properly closed. • Make sure the water supply hose is not frozen. • Make sure the water supply hose is not kinked or clogged. • Make sure there is sufficient water pressure.
<p>After a cycle, detergent remains in the detergent drawer.</p>	<ul style="list-style-type: none"> • Make sure the washer is running with sufficient water pressure. • Make sure the detergent is added to the center of the detergent drawer. • Make sure the rinse cap is inserted properly. • If using granular detergent, make sure the detergent selector is in the upper position. • Remove the rinse cap and clean the detergent drawer.
<p>Excessive vibrations or makes noise.</p>	<ul style="list-style-type: none"> • Make sure the washer is installed on a level, solid floor that is not slippery. If the floor is not level, use the levelling feet to adjust the height of the washer. • Make sure the shipping bolts are removed. • Make sure the washer is not contacting any other object. • Make sure the laundry load is balanced. • The motor can cause noise during normal operation. • Overalls or metal-decorated clothes can cause noise while being washed. This is normal. • Metal objects such as coins can cause noise. After washing, remove these objects from the drum or filter case.
<p>Does not drain and/ or spin.</p>	

If a problem persists, contact a local Samsung service center.



	<ul style="list-style-type: none"> • Make sure the drain hose is neither kinked nor obstructed all the way to the drain system. If there is a drain restriction, call for service. • Make sure the debris filter is not clogged. • Close the door and press or tap START/ PAUSE. For your safety, the washer will not tumble or spin unless the door is closed. • Make sure the drain hose is not frozen or clogged. • Make sure the drain hose is connected to a drain system that is not clogged. • If the washer is not supplied with sufficient power, the washer temporarily will not drain or spin. As soon as the washer regains sufficient power, it will operate normally.
<p>The door does not open.</p>	<ul style="list-style-type: none"> • Press or tap START/PAUSE to stop the washer. • It may take a few moments for the door lock mechanism to disengage. • The door will not open until 3 minutes after the washer has stopped or the power turned off. • Make sure all the water in the drum is drained. • The door may not open if water remains in the drum. Drain the drum and open the door manually. • Make sure the door lock light is off. The door lock light turns off after the washer has drained.
<p>Excessive suds.</p>	<ul style="list-style-type: none"> • Make sure you use the recommended types and amounts of detergent. • Use high efficiency (HE) detergent to prevent oversudsing. • Reduce the detergent amount for soft water, small loads, or lightly soiled loads. • Non-HE detergent is not recommended.



<p>Cannot add additional detergent.</p>	<ul style="list-style-type: none"> • Make sure the remaining amount of detergent and fabric softener is not over the limit.
<p>The washer stops.</p>	<ul style="list-style-type: none"> • Plug the power cord into a live electrical outlet. • Check the fuse or reset the circuit breaker. • Close the door and press START/PAUSE to start the washer. For your safety, the washer will not tumble or spin unless the door is closed. • Before the washer starts to fill, it will make a series of clicking noises to check the door lock and does a quick drain. • There may be a pause or soak period in the cycle. Wait briefly and the washer may start. • Make sure the mesh filter of the water supply hose at the faucets is not clogged. Periodically clean the mesh filter. • If the washer is not supplied with sufficient power, the washer temporarily will not drain or spin. As soon as the washer regains sufficient power, it will operate normally.
<p>Fills with the wrong temperature water.</p>	<ul style="list-style-type: none"> • Fully open both taps. • Make sure the temperature selection is correct. • Make sure the hoses are connected to the correct taps. Flush water lines. • Make sure your water heater is set to supply hot water with a minimum temperature of 120 °F (49 °C) at the tap. Also, check the water heater capacity and recovery rate. • Disconnect the hoses and clean the mesh filters. The mesh filters may be clogged. • While the washer fills, the water temperature may change as the automatic temperature control feature checks incoming water temperature. This is normal.

If the washer fails to operate, you may see an information code on the screen. Check the table



	<ul style="list-style-type: none"> • While the washer fills, you may notice just hot and/or just cold water going through the dispenser when cold or warm temperatures are selected. This is a normal function of the automatic temperature control feature as the washer determines the water temperature.
The load is wet at the end of a cycle.	<ul style="list-style-type: none"> • Use the High or Extra High spin speed. • Use high efficiency (HE) detergent to reduce oversudsing. • The load is too small. Small loads (one or two items) may become unbalanced and not spin completely. • Make sure the drain hose is not kinked or clogged.
Leaks water.	<ul style="list-style-type: none"> • Make sure the door is properly closed. • Make sure all hose connections are tight. • Make sure the end of the drain hose is correctly inserted and secured to the drain system. • Avoid overloading. • Use high efficiency (HE) detergent to prevent oversudsing.
Has odors.	<ul style="list-style-type: none"> • Excessive suds collect in recesses and can cause foul odors. • Run cleansing cycles to sanitize periodically. • Clean the door seal (diaphragm). • Dry the washer interior after a cycle has finished.
No bubbles are seen (BubbleShot models only).	<ul style="list-style-type: none"> • Overloading may screen bubbles. • Severely contaminated laundry may not generate bubbles.

below and try the suggestions.



<p style="text-align: center;">1C</p>	<p>Check the water level sensor.</p> <ul style="list-style-type: none"> • Power the washer off. Wait 2-3 minutes, power the washer on, and then try again. • Depending on the model, the drain system drains water automatically. The POWER and START/PAUSE buttons may be disabled during this process.
<p style="text-align: center;">DC</p>	<p>The door is open.</p> <ul style="list-style-type: none"> • Close the door and press START/PAUSE to resume operation.
<p style="text-align: center;">DC1</p>	<p>Check the door switch.</p> <ul style="list-style-type: none"> • Power the washer off. Wait 2-3 minutes, power the washer on, and then try again.
<p style="text-align: center;">LC</p>	<p>Check for water leaks.</p> <ul style="list-style-type: none"> • Power the washer off, and then check the drain system for any leaks. Once the leak issue is resolved, power the washer on. • Depending on the model, the drain system drains water automatically. The POWER and START/PAUSE buttons may be disabled during this process.
<p style="text-align: center;">4C</p>	<p>Check the water supply line.</p> <ul style="list-style-type: none"> • Check the connection to the water lines (including water taps). • Power the washer off. Wait 2-3 minutes, power the washer on, and then try again. • Depending on the model, the drain system drains water automatically. The POWER and START/PAUSE buttons may be disabled during this process.
<p style="text-align: center;">4C2</p>	<p>Laundry needs protection because the water being supplied is too hot.</p>

Code	Page 23	Action
-------------	---------	---------------

	<ul style="list-style-type: none"> • Make sure the cold and hot water taps are properly connected. • Power the washer off. Wait 2-3 minutes, power the washer on, and then try again.
5C	<p>Check the drain system.</p> <ul style="list-style-type: none"> • Make sure the drain filter is not clogged. • If the drain filter is clogged, clean the filter, and then restart the washer.
HC	<p>Check the washing heater.</p> <ul style="list-style-type: none"> • Power off the washer, and then contact a Samsung service center.
UB	<p>Check the spinning process.</p> <ul style="list-style-type: none"> • The load may not be balanced inside the drum. Check the drum and make sure the load is balanced. • Press START/PAUSE to resume operation or power the washer off, wait 2-3 minutes, power the washer on, and then try again.
8C, 8C1, 8C2	<p>Check the MEMS sensor.</p> <ul style="list-style-type: none"> • Power the washer off. Wait 2-3 minutes, power the washer on, and then try again.
OC	<p>Water may overflow.</p> <ul style="list-style-type: none"> • Close the water valve and call for service.
3C	<p>Check the motor.</p> <ul style="list-style-type: none"> • Power the washer off. Wait 2-3 minutes, power the washer on, and then try again.





4C	<p>Page 24</p> <p>Check the water supply line.</p> <ul style="list-style-type: none"> • Check the connection to the water lines (including water fans)
-----------	--

AC6	<p>Check the PBA communication status.</p> <ul style="list-style-type: none"> • Power the washer off. Wait 2-3 minutes, power the washer on, and then try again.
9C1/9C2	<p>The electronic control needs to be checked.</p> <ul style="list-style-type: none"> • Check if power is supplied properly. • If the information code remains, contact a Samsung service center.
SF	<p>System failed.</p> <ul style="list-style-type: none"> • Power off the washer, and then contact a Samsung service center.



	<ul style="list-style-type: none"> • Power the washer off. Wait 2-3 minutes, power the washer on, and then try again.
OC	<p>Water may overflow.</p> <ul style="list-style-type: none"> • Close the water valve and call for service.
3C	<p>Check the motor.</p> <ul style="list-style-type: none"> • Power the washer off. Wait 2-3 minutes, power the washer on, and then try again.
AC6	<p>Check the PBA communication status.</p> <ul style="list-style-type: none"> • Power the washer off. Wait 2-3 minutes, power the washer on, and then try again.
9C1/9C2	<p>The electronic control needs to be checked.</p> <ul style="list-style-type: none"> • Check if power is supplied properly. • If the information code remains, contact a Samsung service center.
SF	<p>System failed.</p> <ul style="list-style-type: none"> • Power off the washer, and then contact a Samsung service center.

The following symbols provide garment care direction. The clothing care labels include symbols for drying, bleaching, drying and ironing, or dry cleaning when necessary. The use of symbols ensures consistency among garment manufacturers of domestic and imported items. Follow care label directions to optimize garment life and reduce laundering problems.



Wash cycle

	Normal
	Permanent press/Wrinkle resistant/Wrinkle control
	Gentle/Delicates
	Hand wash

Water temperature

	Hot
	Warm
	Cold



Bleach

	Any bleach (when needed)
	Only non-chlorine (color-safe) bleach (when needed)
	Tumble dry

Normal

	Permanent press/Wrinkle resistant/Wrinkle control
	Gentle/Delicates

Special instructions



	Line dry/Hang to dry
	Drip dry
	Dry flat

Heat setting





	High
	Medium
	Low
	Any heat
	No heat / Air

Iron dry or steam temperatures





	High
	Medium
	Low

	No steam (added to iron)
	Do not iron

Warning symbols for laundering

	Do not wash
	Do not wring
	Do not bleach
	Do not tumble dry

Dry-clean

	Dry-clean
	Do not dry-clean
	Line dry / Hang to dry
	Drip dry
	Dry flat

Specification sheet

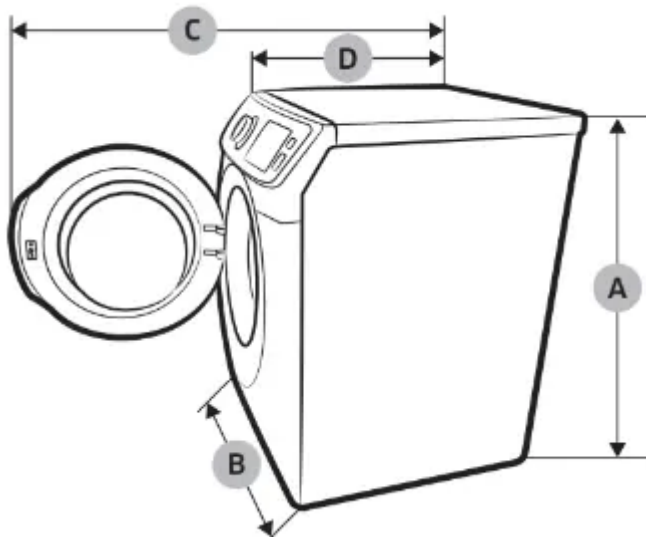

Type			Front loading washer	
			WF45M5500A*	WF45M5100A*
Dimensions (inches (mm))	A. Height-overall		38.7 (984)	
	B. Width		27 (686)	
	C. Depth with door open		54.6 (1387)	
	D. Depth		34 (864)	
Water pressure (psi (kPa))			20-116 (137-800)	
NET weight (lb (kg))			218 (99)	
Spin revolution			1300 rpm	
Heater rating			900 W	-
Power consumption	Washing	120 V	200 W	200 W
	Washing and heating	120 V	1150 W	-
	Spin	120 V	550 W	550 W
	Drain	120 V	80 W	80 W

Warning

This content is compiled from multiple sources and is provided for reference purposes only. It may not be complete or fully applicable to all situations. If you are unable to resolve your issue, please contact the product manufacturer or an authorized service provider for official support.