

Setting up your French Door Refrigerator

GETTING READY TO INSTALL THE REFRIGERATOR

Congratulations on your purchase of this Samsung French Door Refrigerator. We hope you enjoy the state-of-art features and efficiencies that this new appliance offers.

Selecting the best location for the refrigerator

Choose :

- A location with easy access to a water supply.
- A location without direct exposure to sunlight.
- A location with a level floor.
- A location with enough space for the refrigerator doors to open easily.
- A location that allows sufficient space to the right, left, back and top for air circulation.
- A location that allows you to move the refrigerator easily if it needs maintenance or service.
- Do not install the refrigerator in locations where the temperature is over 110 °F (43 °C) or below 50 °F (10 °C).
- Do not locate the refrigerator where it may become wet.

If the refrigerator does not have enough space, it can cause the bad influence to refrigeration efficiency and power consumption.

If your refrigerator has an ice maker, allow extra space at the back for the water line connections.

When you install the refrigerator next to a fixed wall, you need a minimum clearance of 3 3/4" (95 mm) between the refrigerator and wall to allow the door to swing open.

Important : Make sure that you can easily move your refrigerator to its final location by measuring doorways (both width and height), thresholds, ceilings, stairways, etc.

The following chart details the exact height and depth of this Samsung French Door Refrigerator.

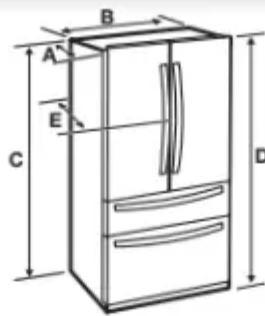

Model	RF24FS**
Depth "A"	28 5/8" (726 mm)
Width "B"	35 6/8" (908 mm)
Height "C"	68 7/8" (1749 mm)
Overall Height "D"	70" (1777 mm)
Depth "E"	31" (788 mm)

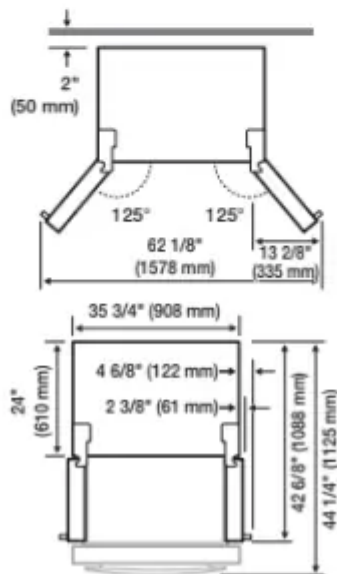

NOTE: Each measurement based on the design dimension, so it may differ depending on the measuring method.

When moving your refrigerator

CAUTION: To prevent floor damage, be sure the front adjusting legs are in the up position (above the floor). Refer to 'Adjusting the Level' in the manual (on page 13).



Flat-blade screw driver(-) Control Lever

FLOORING

For proper installation, you must place this refrigerator on a level, hard surface that is the same height as the rest of the floor. This surface should be strong enough to support a fully loaded refrigerator.

To protect the finish of the flooring, cut a large section of the cardboard carton and place it under the refrigerator where you are working. When moving the refrigerator, you need to pull and push it straight forwards or back. Do not wiggle it from side to side.

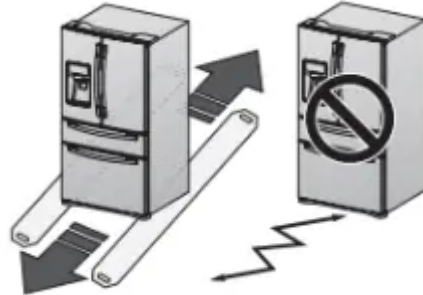

REMOVING THE REFRIGERATOR DOORS

For some installations you need to remove the fridge and freezer drawers so you can move the refrigerator to its final location. **Do not remove the doors/drawer if you don't need to.** If you do not need to remove the refrigerator doors, go to Adjusting the Level on page 13. If you need to remove the doors, continue below.

Before removing the door/drawer, make sure you read the following items:

WARNING: Disconnect power to the refrigerator before removing the door or drawer.

NOTE:

- Be careful not to drop, damage, or scratch the doors/drawers while removing them.
- Use care when you remove the doors/drawers. The doors are heavy and you could injure yourself.
- Reattach the doors/drawers properly to avoid:
 - Moisture from air leakage.
 - Uneven door alignment.
 - Wasting energy due to improper door seal.

Disassemble the refrigerator doors

WARNING: Be careful not to drop and scratch the doors while removing them.

Required Tools (Not provided)

You need the following tools to complete the installation of your refrigerator:

Philips screwdriver(+)	Flat-blade screw driver(-)	Socket wrench (10mm)
Pliers	Allen wrench (3/16") (5mm)	

With the door opened

1. Remove the 3 screws holding down the TOP TABLE (**1**) and separate the connected wires.

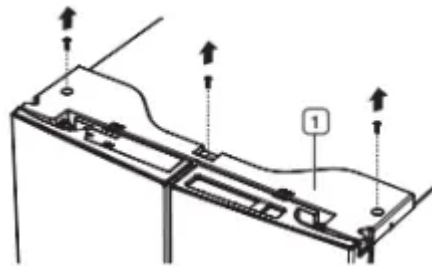

2. Disconnect the two connectors (**2**) on the left side door. To remove the water coupler from the hinge, twist and pull it from the hinge.

Remove the water line (**3**) while pressing the marked part (**4**) of the water line coupler.

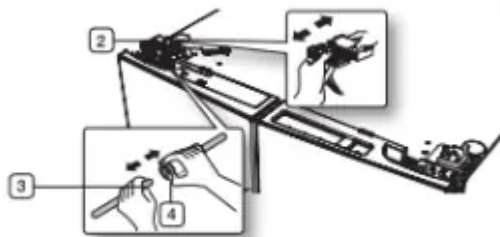

3. Pull and remove the hinge lever (**5**). Remove the ground screw (**6**) attached to the upper left door hinges with a philips screwdriver (+).

Remove the upper left and right door hinges

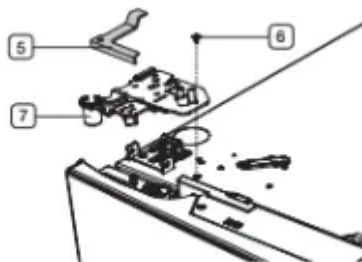

4. Lift the door straight up to remove.

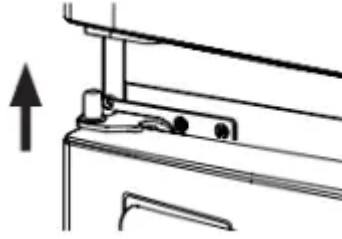

5. Remove the screw (**8**) attached to the lower left and right door hinges with a philips screwdriver (+). Remove the 2 hex head bolts attached to the lower left and right door hinges with an allen wrench (**3/16"**). Remove the lower left and right door hinges (**10**)

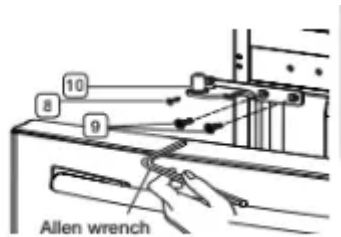

RE-ATTACHING THE REFRIGERATOR DOORS

To reattach the fridge doors after you have moved the fridge to its final location, assemble the parts in reverse order.

1. The Water Line must be fully inserted into the center of the transparent coupler (Type A) or the Guide Lines (Type B) to prevent water leakage from the dispenser.

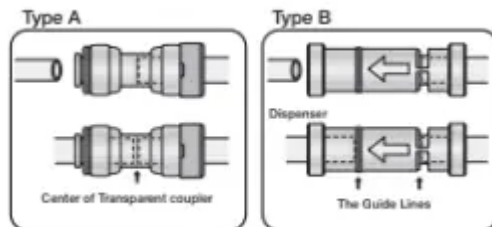

DISASSEMBLING THE FLEX DOOR

1. Take out the Flex Zone (**1**) by lifting it up.

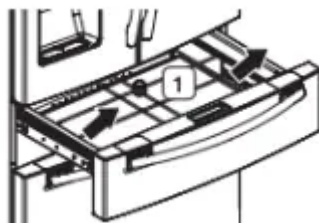

2. Take off the cover (**2**) w/harness with a flat- blade screwdriver (-).

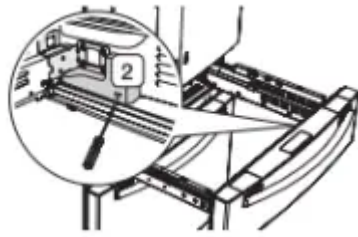

3. Press the locking tab and separate the Wire Connector.

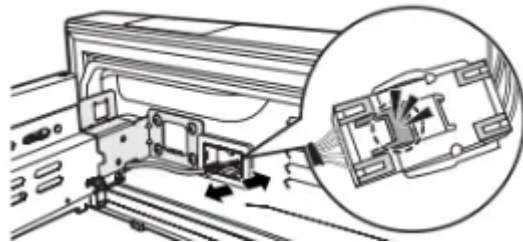

CAUTION: When reassembling it, be sure to connect the wire harness. If it is not connected, the Flex Room does not work.

4. Remove 1 hex head bolt from each side with a socket wrench (10 mm).

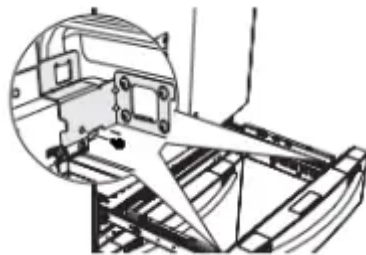

5. Lift up the Flex door from the rails.

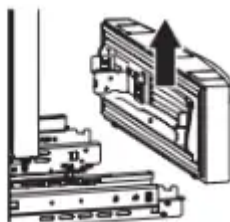

CAUTION: Putting too much food into the freezer drawers can prevent the freezer from closing completely and can cause frost build-up.

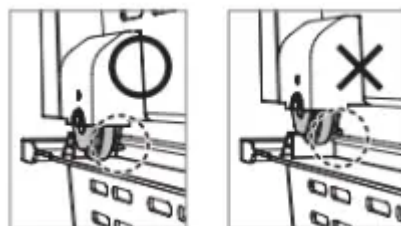

RE-ASSEMBLING THE FLEX DOOR

To reattach the flex doors, assemble parts in reverse order.

CAUTION: Be sure to connect the Flex Door Wire Connector. If it is not connected, the Flex Room does not work.

DISASSEMBLING THE FREEZER DOOR

1. Take out the upper drawer by lifting it up.

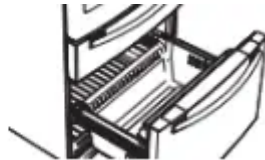

2. Remove the freeze room guard (1) by lifting the guard up.

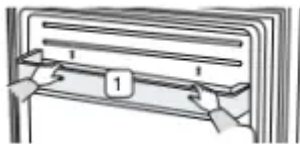

3. Take out the lower basket (2) by lifting the basket up from the rail system.

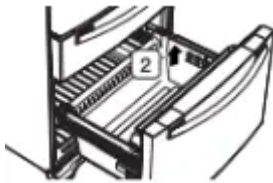

4. Press the fixing hook of the rail system.

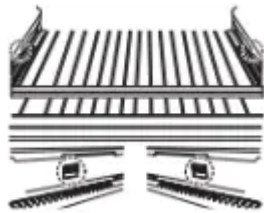

5. Holding the top of the Freezer Drawer, pull it out all the way, and then remove it from the rail system.

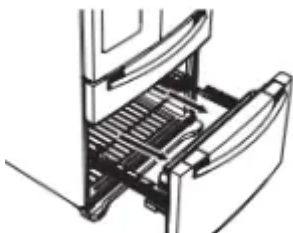

CAUTION: Be careful not to scratch or dent the sliding rail by letting it strike the floor.

CAUTION: Make sure that you mount the freezer basket in the right position when removing installing the freezer door. Failing to do so may result in the door not opening or closing properly.

CAUTION: Putting too much food into the freezer drawers can prevent the freezer from closing completely and can cause frost build-up.

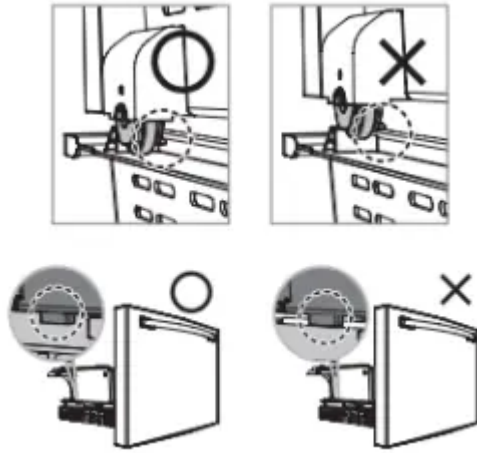

RE-ASSEMBLING THE FREEZER DOOR

To reattach the drawer after you have moved the fridge to its final location, assemble the parts in reverse order.

ADJUSTING THE LEVEL

Make sure the refrigerator is level so that you can make final adjustments. Use a level to test if the refrigerator is level both side to side and back to front. If the refrigerator is not level, you will not be able to get the doors perfectly even, which may cause moisture condensation and increased energy bills. Below is an example of how to level the refrigerator if the left side of the refrigerator is lower than the right side.

How to adjust the level

1. Open the freezer drawer and remove the lower basket.
2. Insert a flat-blade screwdriver (-) into the notch on the left control lever, and turn it counter- clockwise to level the refrigerator. (You turn the lever clockwise to lower the refrigerator and counterclockwise to raise it.)

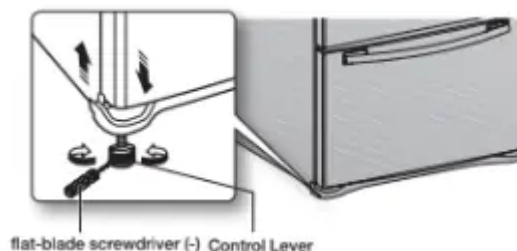

CAUTION: Both control levers must be touching the floor to avoid possible personal injury or property damage because of tipping.

NOTE: If the right side is lower, perform the same procedure, but with the right control lever.



NOTE: It is difficult to remove the cover leg front from the refrigerator, so we do not recommend making small adjustments with the control lever. Instead, refer to the next page for the best way to make minor adjustments to the doors.

MAKING MINOR ADJUSTMENTS TO THE DOORS

Remember, a leveled refrigerator is necessary for getting the doors perfectly even. If you need help, review the previous section on leveling the refrigerator.



NOTE: The left door is fixed. To make minor door adjustments, adjust only the right door.

1. Pull out the flex door (**1**) to reveal the lower hinge (**2**).
2. Insert a philips screwdriver (+) (**3**) into the shaft (**4**) of the lower hinge.
3. Adjust the height by turning a philips screwdriver (+) clockwise (**3**) () or counterclockwise ().

NOTE: When you turn a philips screwdriver (+) counterclockwise (), the door will move up.

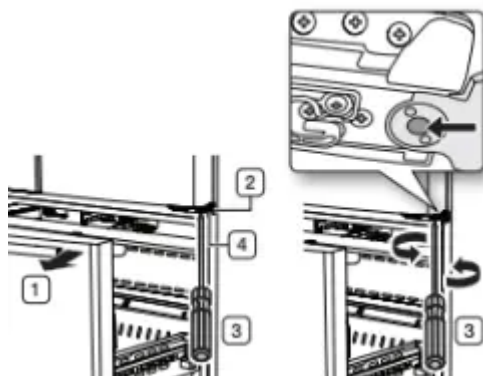

INSTALLING THE WATER DISPENSER LINE

A water dispenser with a filter is one of the helpful features on your new refrigerator. To help promote better health, the water filter removes unwanted particles from your water. However,

it does not sterilize or destroy microorganisms. You may need to purchase a water purifying system to do that.

The water line also connects to the ice maker.

For the ice maker to operate properly, water pressure of 20-125 psi (138 ~ 862 kPa) is required.

If the refrigerator is installed in an area with low water pressure (below 20 psi), you can install a booster pump to compensate for the low pressure.

After you have connected the water line, make sure the water storage tank inside the refrigerator is properly filled. To do this, press the water dispenser lever until the water runs from the water outlet.

NOTE: Water line installation kits are available at extra cost from your dealer. We recommend using a water line installation kit that contains copper tubing and 1/4" compression nut.

Connecting to the water supply line

1. First, shut off the main water supply.



2. Locate the nearest cold water drinking line and install the pipe clamp and shut off valve.

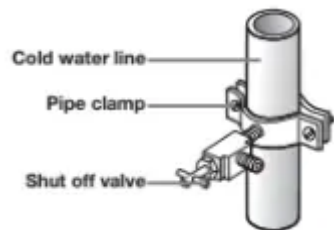

3. Connect the water line installation kit to the shut off valve.

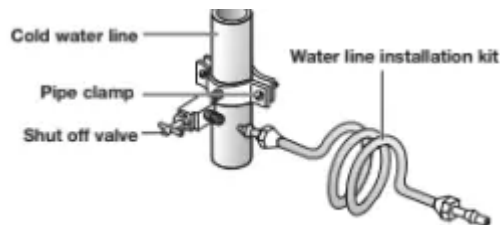

Connecting the water supply line to the refrigerator.

There are several items that you need to purchase to complete this connection.

You may find these items sold as a kit at your local hardware store.

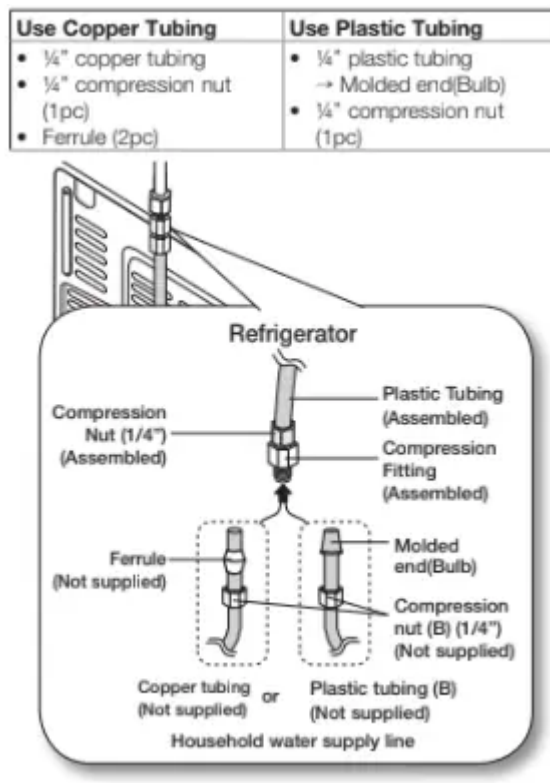

1. Connect the household water line to the assembled compression fitting.

- If you are using copper tubing, slip the compression nut (**B**) (not supplied) and ferrule (not supplied) on the copper tubing (not supplied) as shown.
- If you are using plastic tubing (**B**) , insert the molded end (Bulb) of the plastic tubing (**B**) into the compression fitting.

CAUTION: Do not use without the molded end (Bulb) of the plastic tubing (**B**).

2. Tighten the compression nut (**B**) onto the compression fitting.

Do not over-tighten the compression nut (**B**) .

3. Turn the water on and check for any leakage. If you find water drops or leakage in the connection areas, turn off the main water supply. Check the connections and, if necessary, tighten.

4. Flush 1 gallon of water through the filter before drinking or using the water from the refrigerator. (Flush approximately 6 minutes.)

To flush, press a large glass or cup against the water dispenser lever. Fill the glass, empty it into the kitchen sink after it is filled, and then repeat.

5. After you turn on the refrigerator, let the ice maker make ice for 1 to 2 days. Over that period of time, throw out the first 1 or 2 buckets of ice the freezer makes to ensure all impurities have been removed from the water line.

NOTE: Only connect the water line to a drinkable water source. If you have to repair or disassemble the water line, cut off 1/4" of the plastic tubing to make sure you get a snug, leak-free connection.

NOTE: You can test the water line quickly using a paper cup. Under normal conditions, the water dispenser can fill a 5.75 oz. (170cc) cup in about 10 seconds.

COMPLETING THE SET UP

Now that you have your new refrigerator installed in place, you are ready to set up and enjoy the features and functions of the appliance.

By completing the following steps, your refrigerator should be fully operational.

1. Make sure your refrigerator is in an appropriate location with reasonable clearance between it and the wall. Refer to installation instructions in this manual.
2. Once the refrigerator is plugged in, make sure the interior light comes on when you open the doors.
3. Set the Temperature control to the coldest temperature and wait for an hour. The freezer will get slightly chilled and the motor will run smoothly. Reset the refrigerator and freezer to the temperatures you want.
4. After you plug the refrigerator in, it will take a few hours to reach the appropriate temperature. You can store food and drinks in the refrigerator after the temperature is sufficiently cool.

NOTE: If condensation or water drops appears on both sides of fridge door's central part, turn the Energy Saver mode off after removing the condensation. (See the explanation on Energy Saver button in the USING THE CONTROL PANEL.)

Operating your French Door Refrigerator

USING THE CONTROL PANEL

RF24FS**

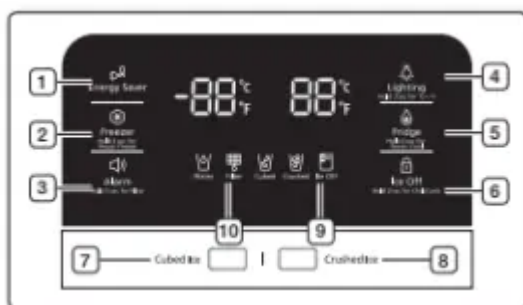

(1) Energy Saver

Touching this button turns Energy Saver mode on and off. When you turn Energy Saver on, the Energy Saver icon lights.



Turn Energy Saver off and the icon goes off. The Energy Saver function's factory setting is "ON". If condensation or water drops appear on the doors, turn the Energy Saver mode off.

(2) Freezer (Hold 3 sec for Power Freezer)

The Freezer button serves two purposes:

- To set the Freezer to your desired temperature.
- To turn the power freezer function on and off.

1) To set the Freezer temperature. Touch the Freezer button to set the Freezer to your desired temperature. You can set the temperature between 5 °F (-15° C) and -8 °F (-23 °C).

2) Power Freezer function

Touch and hold this button for 3 seconds to decrease the time needed to freeze products in the Freezer.

It can be helpful if you need to quickly freeze easily spoiled items or if the temperature in the freezer has warmed dramatically (For example, if the door was left open).



When you use this function the energy consumption of the refrigerator will increase.

Remember to turn it off when you don't need it and return the freezer to your original temperature setting. If you need to freeze large amount of food stuff, activate Power Freeze function at least 24 hours before.

(3) Alarm (Hold 3 sec for Filter Reset)

The Alarm button serves two purposes:

- To turn the door open alarm on and off
- To reset the water filter life indicator.

1) Door Alarm Function

If the door alarm is set to On, an alarm beeps if any refrigerator door is left open for more than three minutes. The beeping stops when you close the door. The door alarm function is pre-set to On in the factory. You can turn it off by pressing and then releasing the Alarm button. You can turn it back on in the same fashion. The icon lights up when the function is on. When the Door Alarm function is on and the alarm sound is triggered, the Door Alarm Icon will blink while the alarm sounds.



2) Water Filter Life Indicator Function

After you replace the water filter, touch and hold this button for 3 seconds to reset the water filter life indicator. When you reset the water filter life indicator, the Filter icon on the panel

turns Off. The Filter icon will turn red to let you know it is time to change the water filter after six months (about 300 gallons). Some areas have large amounts of lime in their water, which causes the water filter to clog more quickly. If this is the case in your area, you will have to change the filter more frequently than every six months.

(4) Lighting (Hold 3 sec for °C ↔ °F)

Lighting button serves two purposes:

- To turn the dispenser light on and off
- To switch the temperature units between oC and oF

1) Light Function

Touching the Lighting button turns on the Dispenser LED lamp in continuous mode so that it stays on continuously. The button also lights up. If you want the Dispenser lamp to come on only when some one uses the dispenser, press the Lighting button to turn the continuous mode off.



2) To switch the temperature units between °C and °F

Touch and hold this button for 3 seconds to select the temperature display you want. Each time you press and hold the button, the °C and °F temperature modes alternate and the oC or oF icon lights up, indicating your selection.

(5) Fridge (Hold 3 sec for Power Cool)

The Fridge button serves two purposes:

- To set the Fridge to your desired temperature.
- To turn the Power Cool function on and off.

1) To set the Fridge temperature. Press the Fridge button to set the refrigerator to the temperature you want. You can set the temperature between 44 °F (7 °C) and 34 °F (1 °C).



2) Power Cool function

Touch and hold this button for 3 seconds to decrease the time needed to cool products in the Refrigerator. It can be helpful if you need to quickly cool easily spoiled items or if the temperature in the fridge has warmed dramatically (For example, if the door was left open).

(6) Ice Off (Hold 3 sec for Child Lock)

The Ice Off button serves two purposes:

- To turn the Ice maker on and off

- To turn the Child Lock Function on and off.

1) Ice Off Function

If you don't want to make more ice, press the Ice Off button.



2) Child Lock Function

Touch and hold this button for 3 seconds to lock the display, the Flex Zone panel, and the dispenser buttons so the buttons can not be used.

Replace the highlighted text with this text:

When Child Lock is on, the refrigerator does not dispense ice, water, or sparkling water, even if the Dispenser Lever is pressed.

The Child Lock icon lights up to indicate you've activated the Child Lock function.

Press 3 seconds to unlock.

(7) Cubed Ice (8) Crushed Ice

Press the Cubed Ice or Crushed Ice button to select the type of ice you want dispensed.



Each time you press the button, the cubed and crushed ice modes alternate and the Cubed or Crushed ice icon lights up, indicating your selection.

(9) Ice Off

If you don't want to make more ice, touch the Ice Off button. The icon will light up and the Ice-Maker stops making ice.

NOTE: We recommend you stop ice making if the following occur:

- There is enough ice in the ice bucket.
- You want to save water and energy.
- Water is not being supplied to the refrigerator.



NOTE: If the ice maker function is ON, and the water line is not connected, there will be a water valve noise from the back of the unit. If this occurs, press the Ice Off (Hold sec for child lock) button for less than 3 seconds until the Ice Off Indicator () illuminates.

To save electricity, the Panel Display turns off automatically under the following conditions:

When no button has been pressed, when no doors are open, or when no Dispenser

Lever has been pushed. However, the icon indicating your cubed or crushed ice selection, or sparkling water selection, will stay on.

When you press a button, open a door, or push a Dispenser Lever, the Panel Display will turn on again. All function keys will become operational after you remove your finger from the button you pressed.

(10) Filter

Water filter usage

This icon lights up when you need to change the filter, usually after the refrigerator has dispensed about gallons of water (after about months). The icon will blink red for several seconds when you open or close the door.

After you install the new water filter, reset the filter indicator by touching and holding the Hold 3sec for Filter Reset button for 3 seconds.



NOTE:

- If water is not dispensing or dispensing slowly, you need to replace the water filter because the water filter is clogged.
- Some areas have large amounts of lime in their water, which causes the water filter to clog more quickly.

Cooling Off Mode

- North American (US, Canada) Models Only ; Cooling Off mode (also called Shop mode), is designed for use by retailers when they are displaying refrigerators on the shop floor. In Cooling Off mode, the refrigerator's fan motor and lights work normally, but the compressors do not run, and the refrigerator and freezer do not get cold. To start Cooling Off mode, touch and hold the Energy Saver button and the Freezer button for 5 seconds during normal operation. The refrigerator chime sounds and the temperature display flashes OFF.

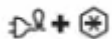

To cancel Cooling Off mode, touch and hold the Energy Saver and the Freezer buttons again for 5 seconds.

CHANGING THE WATER FILTER

WARNING: To reduce the risk of water damage to your property DO NOT use generic brands of water filters in your SAMSUNG Refrigerator.

USE ONLY SAMSUNG BRAND WATER FILTERS. SAMSUNG is not legally responsible for any damage, including, but not limited to, property damage caused by water leakage from

the use of a generic water filter. SAMSUNG Refrigerators are designed to work ONLY WITH SAMSUNG Water Filters.



The Filter light turns red to let you know when it is time to change your water filter cartridge. To give you time to get a new filter, the red light comes on just before the capacity of the current filter runs out. Changing the filter on time provides you with the freshest, cleanest water from your refrigerator.



To change the water filter, follow these steps:

1. Shut off the water supply. Then, turn the water filter (1) about 1/4 turn, counter-clockwise.
2. Pull the water filter (1) from the case filter (2).

NOTE:

- To change the water filter more easily, shut off the water supply valve.
- Sometimes, it is hard to disassemble the water filter because impurities in the water cause it to stick. If you are having difficulties, grip the water filter firmly and pull it hard.
- When you pull the water filter, a little water can leak from the opening. This is normal. To minimize the water leaks, keep the filter cartridge horizontal when you pull it.
- To prevent overflow, empty the water filter tray (3) and dry around the filter case (2).

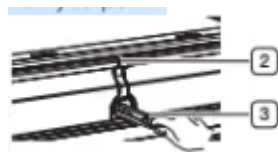



3. Insert the new filter into the filter case (4).
4. Push the filter, and then turn it clockwise until it locks.

NOTE:

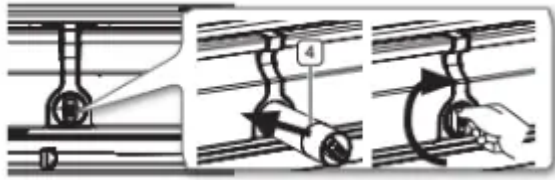
- If you have trouble inserting the water filter because of high water pressure, shut off the water supply valve.
- The locked symbol should be lined up with the indicator line.



5. Touch the “**Alarm/hold sec for Filter Reset**” button ( (**Filter Reset**)) for about 3 seconds to reset the water filter. The color of the indicator () changes from red to off.
6. If you turned off the water supply, turn it back on.



NOTE: For a replacement water filter, you can visit your local home Improvement center or contact the Samsung Parts distributor. To order more water filter cartridges, contact your authorized Samsung dealer. Be sure the replacement water filter has the SAMSUNG logo on the box and on the water filter.

Removing any residual matter inside the water supply line after installing the water filter.

1. Turn ON the main water supply and supply water from water supply line.
2. Run water through the dispenser until the water runs clear (approx. 6 to minutes). This will clean the water supply system and remove air from the lines.
3. Additional flushing may be required in some households.
4. Open the Refrigerator door and make sure there are no water leaks coming from the water filter.



NOTE: Be sure to flush the dispenser thoroughly, otherwise water may drip from the dispenser. This means that there is still air in the line.

Reverse Osmosis Water Supply

IMPORTANT:

The pressure of the water supply coming out of a reverse osmosis system going to the water inlet valve of the refrigerator needs to be between 35 and 120 psi (241 and 827 kPa).

If a reverse osmosis water filtration system is connected to your cold water supply, the water pressure to the reverse osmosis system needs to be a minimum of 40 to 60 psi (276 to 414

kPa.) If the water pressure to the reverse osmosis system is less than 40 to 60 psi (276 to 414 kPa):

- Check to see whether the sediment filter in the reverse osmosis system is blocked. Replace the filter if necessary.
- Allow the storage tank on the reverse osmosis system to refill after heavy usage.
- If your refrigerator has a water filter, it may further reduce the water pressure when used in conjunction with a reverse osmosis system. Remove the water filter.

If you have questions about your water pressure, call a licensed, qualified plumber.

CONTROLLING THE TEMPERATURE

Basic temperature of Freezer and fridge compartments

The basic and recommended temperatures of the Freezer and Fridge compartments are 0°F and 37 °F (or -18 °C and 3 °C) respectively. If the temperature of the Freezer and Fridge compartments are too high or low, adjust the temperature manually.

Controlling the Freezer temperature

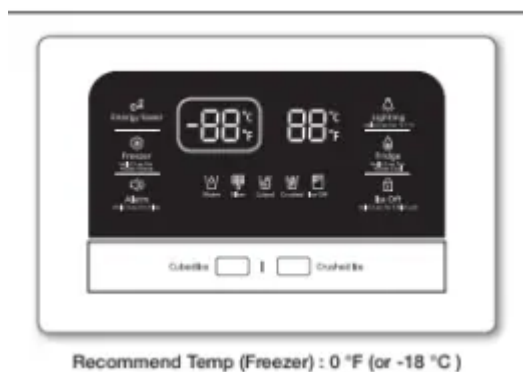

The Freezer temperature can be set between -8 °F and 5 °F (or between -23 °C and -15 °C) to suit your particular needs. Press the Freezer button repeatedly until the desired temperature is shown in the temperature display. The temperature will change by 1 °F (or 1 °C) with each press. See below.

Fahrenheit : 0 °F → -1 °F → -2 °F → -3 °F → -4 °F → -5 °F → -6 °F → -7 °F → -8 °F → 5 °F → 4 °F → 3 °F → 2 °F → 1 °F → 0 °F.

Centigrade : -18 °C → -19 °C → -20 °C → -21 °C → -22 °C → -23 °C → -15 °C → -16 °C → -17 °C → -18 °C.

Keep in mind that foods like some ice cream may melt at 4 °F (or -15.5 °C). The temperature display will move sequentially from -8 °F to 5 °F (or from -23 °C to -15 °C).

Controlling the fridge temperature



Recommend Temp (Fridge) : 37 °F (or 3 °C)

The fridge temperature can be set between 34 °F and 44 °F (or between 1 °C and 7 °C) to suit your particular needs. Press the Fridge button repeatedly until the desired temperature is shown in the temperature display. The temperature will change by 1 °F (or 1 °C) with each press. See below.

Fahrenheit : 37 °F → 36 °F → 35 °F → 34 °F → 44 °F → 43 °F → 42 °F → 41 °F → 40 °F → 39 °F → 38 °F → 37 °F.

Centigrade : 3 °C → 2 °C → 1 °C → 7 °C → 6 °C → 5 °C → 4 °C → 3 °C.

The temperature control process for the Fridge works just like the Freezer process. Press the Fridge button to set your desired temperature.

After a few seconds, the Fridge will begin adjusting towards the newly set temperature. This will be reflected in the digital display.

NOTE:

- The temperature of the Freezer or Fridge may rise when you open the doors too frequently, or if a large amount of warm or hot food is placed inside.
- A rise in temperature may cause the digital display to blink. Once the Freezer and Fridge temperature return to their normal set temperatures, the blinking will stop.
- If the blinking continues, you may need to reset" the Refrigerator. Try unplugging the appliance, wait for around 10 minutes and then plug the power cord back in.
- If there is a communication error between the Display and Main Controller, the Convertible Display light may blink. If the blinking continues for a long period of time, please contact a Samsung Electronics Service Center.

USING THE COLD WATER DISPENSER

Push the appropriate ice type button to select what you want dispensed.



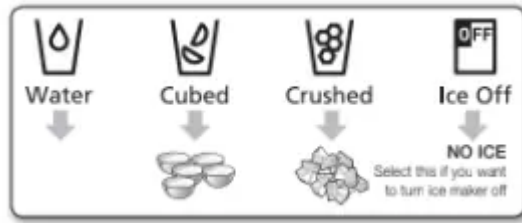

Using the ice lever (1)

Push the Ice lever dispenser (1) gently with your glass. Ice will be released from the dispenser. You can choose the type of ice by pushing the cubed or crushed button first.



Using the Water lever (2)

Push the Water lever dispenser (2) gently with your glass. Water will be released from the dispenser.

NOTE: If you push the water and Ice lever at about the same time, the dispenser operates only the option you actually selected or pushed first.

NOTE: Please wait 1 second before removing the cup after dispensing water to prevent spills. Do not pull out the lever dispenser after dispensing ice or water. It comes back automatically.

Using the Ice & Water Dispenser together

To get Ice and water, push the Ice lever (1) first for ice, then move your glass down and press the water dispenser lever (2) for water.

Maintaining the Ice Bucket

- To clean the ice bin/bucket, wash with a mild detergent, rinse well, and dry thoroughly it. Do not use harsh or abrasive cleaners or solvents.
- Ice is made in cubes. When you select "Crushed", the ice maker grinds the ice cubes into crushed ice.
- When you select Cubed Ice after using the Crushed Ice mode, a small amount of residual crushed ice might be produced.
- The ice cubes generated by the rapid ice making process will look white, which indicates they were generated normally.

- As the ice maker in the refrigerator room makes ice cubes even faster, move the ice cubes from the refrigerator ice bin to the freezer ice bin if you need more ice cubes.
- If ice doesn't come out, pull out the ice bucket and press the test button located on the right side of ice maker. See the illustration below.
- Do not press the test button continuously when the tray is filled with ice or water. Water may overflow or ice may jam the bucket.

Making Ice

- To fill the ice bucket to maximum capacity after installation, follow these steps:

1. Allow your refrigerator to operate and cool down for 24 hours (or 1 full day).

- Waiting 24 hours will allow your ice maker to cool properly.

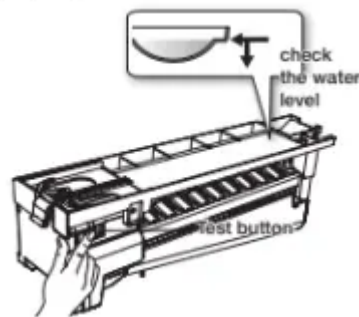

2. Dispense 4 to 6 ice cubes into the glass.

3. After 8, and then 16 hours, dispense a full glass of ice.

- To test the ice maker, press the Test button on the ice maker. You will hear the refrigerator chime (ding-dong). When the chime sounds, release the Test button.
- The chime sounds automatically again to let you know the ice maker is working well.

CAUTION: If you want to remove the ice cubes without using the ice bucket, please turn the ice maker off and remove the ice maker's front cover from the ice maker. Note that the ice cubes in the ice maker can spill out over the drawer.

CAUTION: Do not put food in the ice bucket. If you store food in the ice bucket, the food can strike the ice maker when you open or close the door, causing damage to the ice maker.

CAUTION: Note that the ice cubes in the ice bucket may spill out over the drawer when you remove the ice bucket from the drawer. If this occurs, be sure to clear the ice cubes that spilled out of the drawer. If a power failure occurs, ice cubes may melt, and then freeze together when the power comes back on, causing the dispenser to stop working.

To prevent this problem, after a power failure, pull out the ice bucket and discard the residual ice or water.

NOTE: If you use all the ice at once, you must repeat ice making Steps 2 and 3, left. However, only wait 8 hours before dispensing the first 4 to 6 ice cubes. This will replenish the ice cubes and ensure maximum ice production.

Using the ice off Function

When you select the Ice Off mode, remove all ice cubes from the bucket.

If you leave the ice cubes in the bucket, the ice cubes may clump together, making it difficult to remove them.

To remove the ice bucket safely and avoid injury, hold the bottom of the bucket with one hand and the side of the bucket with the other.

Then, lift up on the ice bucket, and pull it straight out.

To put the ice bucket back in, push it firmly straight back.

NOTE: If the ice bucket is not pushed firmly into place, ice in the bucket can melt.

If the bucket does not fit, turn the helix 90 degree see the last illustration on the right, below) and try again.

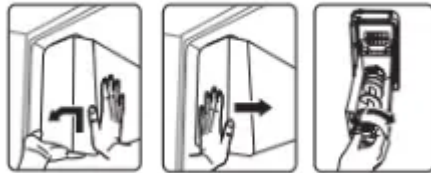

CAUTION:

- The inside of the ice bucket is very cold when the refrigerator is operating. Do not reach deep inside the ice bucket.
- Use only the ice maker provided with the refrigerator. The water supply to this refrigerator must only be installed/connected by a suitably qualified person. Connect to a potable water supply only.
- To operate the ice maker properly, water pressure of 20 ~ 125 psi is required.

Going on vacation...

If you have a long vacation or business trip and won't use the water or ice dispensers for a long time:

- Close the water valve. Otherwise, water leakage may occur.
- Remove all food and ice in the ice bucket.
- Unplug the refrigerator.
- Wipe excess moisture from inside and leave the doors open. Otherwise, odor and mold may develop.

Ice Maker Do's and Don'ts

- Do not put your fingers, hands or any other unsuitable objects in the chute or ice-maker bucket
 - It may result in personal injury or material damage.
- Never put your finger or any other objects in the dispenser opening.
 - It may cause injury.
- Do not try to disassemble the ice maker.
- Do not wash or spray the ice bucket with water while it is in the refrigerator. Remove it to clean it

CAUTION: When you insert the Ice maker tray, be sure that the tray is well centered at the entrance. Otherwise, the tray may get stuck.

Water clouding phenomenon

NOTE: All water provided to the refrigerator flows through the core filter which is an alkaline water filter. In the filtering process, the pressure of the water that has flowed out of the filter is increased, and the water becomes saturated with oxygen and nitrogen. When this water flows out into the air, the pressure plummets and the oxygen and nitrogen get supersaturated, which results in gas bubbles. The water may temporarily look misty or cloudy due to these oxygen bubbles. After a few seconds, the water will look clear.

PARTS AND FEATURES

Review the illustration below to become more familiar with the parts and features of your refrigerator.

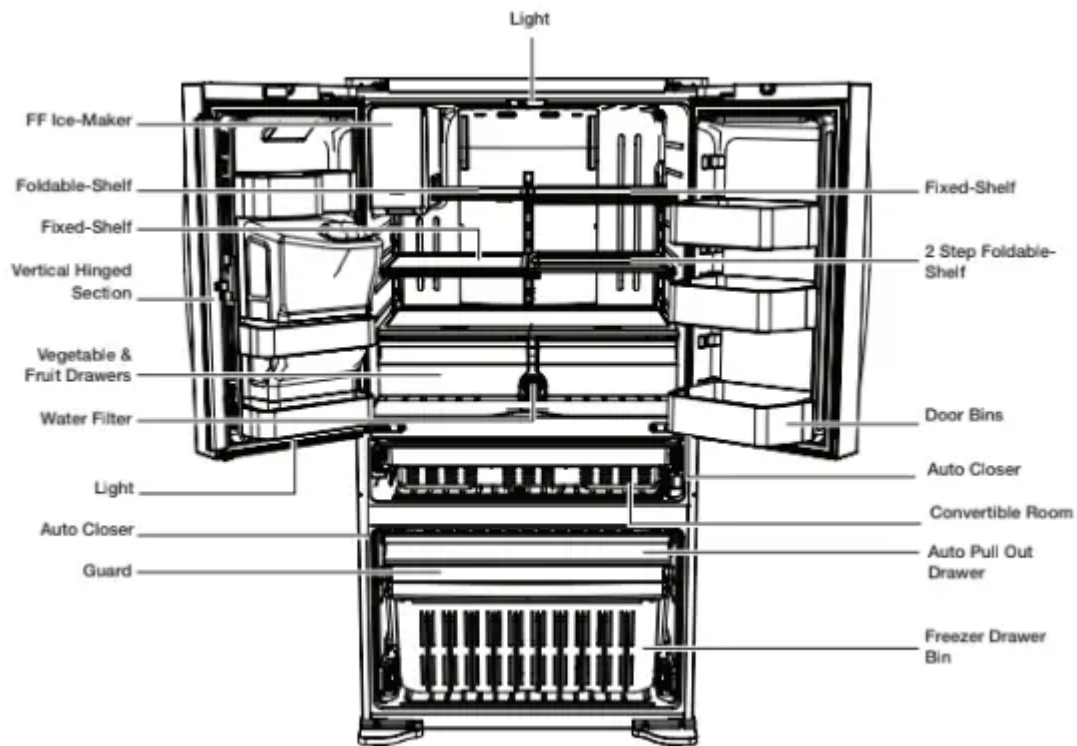

NOTE: When closing the door, make sure the Vertical Hinged Section is in the correct position to avoid scratching the other door. If the Vertical Hinged Section is reversed, put it back to the right position and close the door. Moisture may appear at times on the Vertical Hinged Section. The door handle may become loose over time. If this happens, tighten the bolts found on the inside of the door. If you close one door with too much force, the other door may open.

NOTE: When the door opens, the interlock switch automatically turns off the auger motor in the ice maker for safety reasons.

If the interior or exterior LED lamp has gone out, please contact your service agent.

USING FLEX ZONE

The Flex Zone is a full-width drawer with an adjustable temperature control. You can use the Flex Zone for large party trays, deli items, wines, pizzas, beverages, or miscellaneous items. There is a temperature sensor which lets you adjust the amount of cold air allowed into the Zone. The control buttons are located on the cap door center.

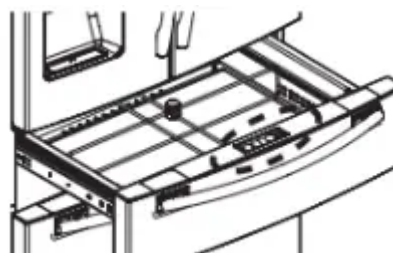

Temperature Selection Button

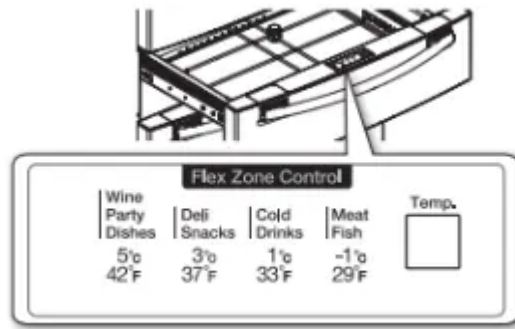

- Press the Temp button repeatedly until your desired mode is lit.
- Each time you press the Temp button, you change the mode in this order: Meat/Fish mode (29 °F(-1 °C)), Cold Drinks mode (33 °F(1 °C)), Deli/Snack mode (37 °F(3 °C)), Wine/Party Dishes mode (42 °F(5 °C)). Initially, the Cold Drinks mode is selected. The refrigerator will adjust the temperature in the Flex Zone automatically to the temperature you selected.
- The Flex Zone Temp. Display may change depending on the number of items inside, where they are located, the ambient temperature, and how often the door is opened.

Selection Button

1. When **“Wine/Party Dishes”** is selected, the temperature of the Flex Zone will be kept around 42 °F (5 °C). This feature helps keep food fresh for a long time.
2. When **“Deli/Snack”** is selected, the temperature of the Flex Zone will be kept around 37 °F (3 °C). This feature helps keep food fresh for a longer time.
3. When **“Cold Drink”** is selected, the temperature of the Flex Zone will be kept around 33 °F (1 °C). This feature helps keep drinks cold and refreshing.
4. When **“Meat/Fish”** is selected, the temperature of the Flex Zone will be kept around 29 °F (-1 °C). This feature helps keep meat or fish fresh for a longer time.

Examples of food items you can store in the Flex Zone by temperature setting.

Wine Party Dishes	Deli Snacks	Cold Drinks	Meat Fish
• wine	• pineapples	• bottled water	• steaks
• cocktails	• lemons	• juice	• cold cuts
• cakes	• biscuits	• soft drinks	• bacon
• cheeses	• potatoes	• beer	• chili dogs

NOTE: Fruit and vegetables may be damaged if stored under the “Meat Fish” setting. Do not store lettuce or other leafy produce in the Flex Zone.

NOTE: Do not store glass bottles in the Flex Zone under the “Cold Drinks” or “Meat/Fish” setting. If they are frozen, they can break and cause personal injury.

RECOMMENDED LOCATION FOR THE FOLDABLE SHELF

The Foldable Shelf folds up from the center, giving you more storage area for tall items without your having to re-arrange the shelves.

- Install the Foldable Shelf on the right side of the refrigerator.
- If you install the Foldable Shelf on the left side, the ice maker will prevent the shelf from folding completely.
- To use, push the front portion of the shelf back gently so that the shelf folds up from the middle.

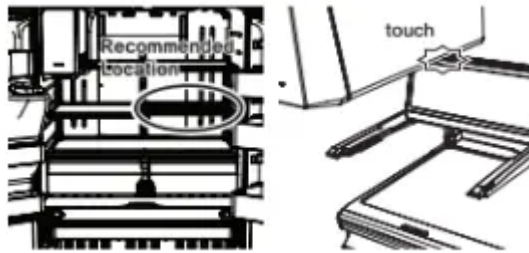

REMOVING THE REFRIGERATOR ACCESSORIES

1. Door Bins

- Door Bins (1)

To remove - Simply lift the bin up and pull straight out.

To relocate - Slide it in above the desired location and push down until it stops.

- Door Bins (2)

To remove - Take the right side of the bin out by lifting it at an angle along the guide, and then take the left side out by pulling it from the door.

To relocate - Slide it into the original location and push down until it sticks.

NOTE: Injuries can occur if the door bins are not firmly connected to the doors. Do not allow children to play with the bins. Sharp corners of the bins may cause injury.

CAUTION: Do not adjust a bin full of food. Remove the food first. To remove dust from the bins, remove the guard and wash in water.

2. Tempered Glass shelves

To remove - Tilt up the front of the shelf in the direction shown (**1**) and lift it up vertically (**2**).

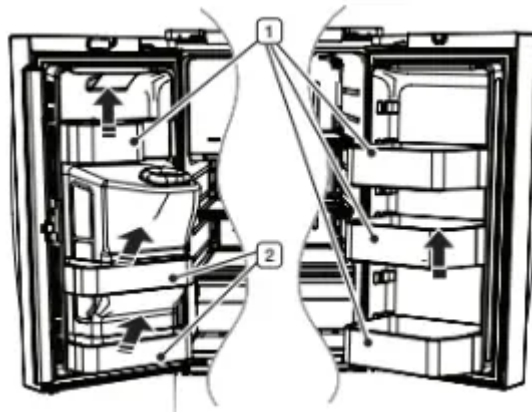

Pull the shelf out.

To re-install - Tilt the front of the shelf up and guide the shelf hooks into the slots at a desired height. Then lower the front of the shelf so that the hooks can drop into the slots.

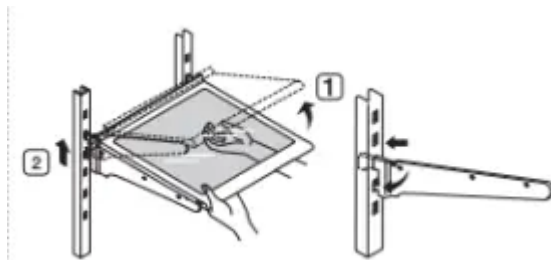

CAUTION: The Tempered Glass shelves are heavy. Use special care when removing them.

3. Foldable Shelf

To remove - After removing the Shelf Front, lift up the Shelf and remove it.

To re-install - Hook the Shelf on the Angle Frame and re-attach the Shelf Front to the Foldable Shelf.

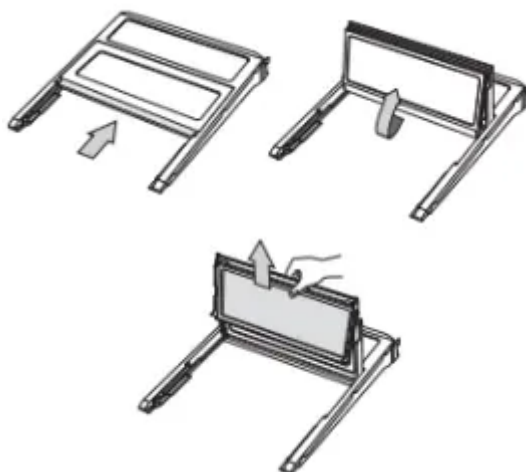

CAUTION: After sliding the foldable shelf in and folding it, the Shelf Front can be removed for your convenience. If you use the self without removing, be careful of its possible separation.

4. Vegetable & Fruit Drawers

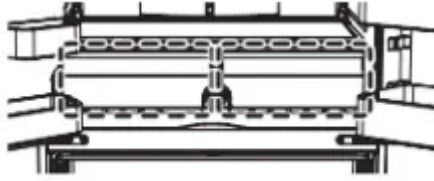

To remove

- Simply lift the bin up and pull straight out.

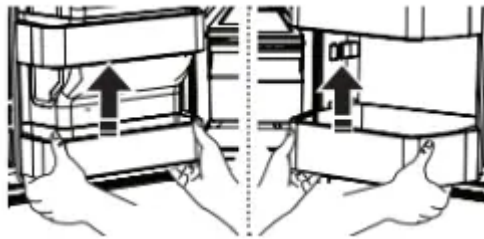

- Tilt up the front of the drawer and pull straight out, and pull out the drawer after moving slightly in the direction of the arrow.

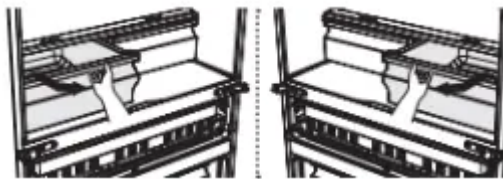

To re-install

- Insert the drawer into the frame rails and push back into place.
- Slide bin in above the desired location and push down until it stops.

CAUTION: The drawers need to be removed before the glass shelf above them can be lifted out.

5. Flex Zone

To remove the Flex Zone – Pull the Flex door out to full extension. Lift the Flex Zone up, pulling it to your body with both hands.

To re-install the Flex Zone – Open the Flex door to full extension. Tilt the front of the Flex Zone up, place the back of the Flex Zone onto the rails, and then lower the front until the whole Zone rests on the rails.

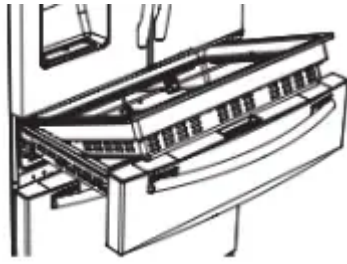

When the Flex Zone or LED lighting is not working, check the connectors [(1), (2) shown below] for cracks or leaks.

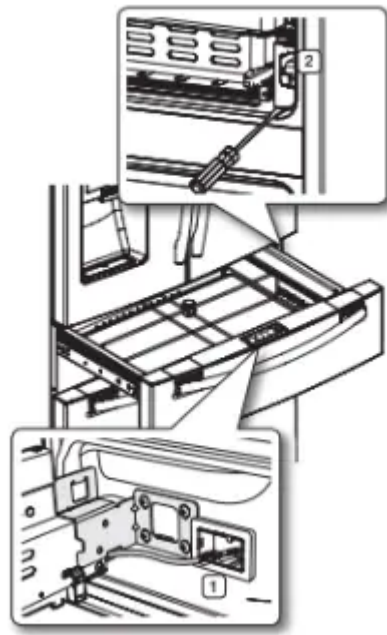

1. Refer to page 12 for disassembly instructions.
2. Open the cap cover rail with a flat-blade screwdriver.

Using the doors

Ensure that the doors close all the way and are securely sealed.

When the refrigerator door is only partially open, it will automatically close. If the the door is opened more than its auto close range, it will remain open.

You must close it manually.

REMOVING THE FREEZER ACCESSORIES

1. Freezer Room Guard

To remove - Remove the freezer room guard (1) by lifting the guard up.

To re-install - Push down until the guard (1) locks into place.



2. Super Extended Drawer

To remove - Pull the drawer out to full extension. Tilt up the rear of the drawer and lift straight out.

To re-install - Place the drawer onto the rails (4) by tilting it up. Lower the drawer into place until it is horizontal and slide the Drawer (3) in.



3. Freezer Drawer

To remove the freezer drawer - Pull the freezer drawer out fully. Tilt up the rear of the bin and lift it out to remove.

To re-install the freezer drawer - Place the bin into the rail assembly.

CAUTION: You can scratch the side of the bin if you twist it left or right when disassembling or re-assembling it.

CAUTION: Do not allow babies or children go inside the freezer drawer. They could damage the refrigerator and seriously injure themselves. Do not sit on the freezer door. The door may break. Do not allow children to climb into the freezer drawer.

CAUTION: Do not remove the divider.

CAUTION: If trapped inside, children may be injured or suffocate to death.

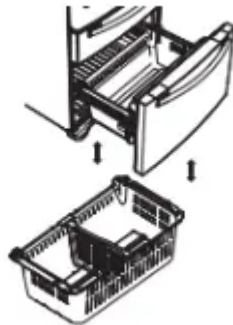

CLEANING THE REFRIGERATOR

Caring for your Samsung French Door Refrigerator prolongs its life and helps keep it free of odor and germs.

Cleaning the Interior

Clean the inside walls and accessories with a mild detergent and then wipe dry with a soft cloth. You can remove the drawers and shelves for a more thorough cleaning. Just make sure to dry drawers and shelves before putting them back into place.

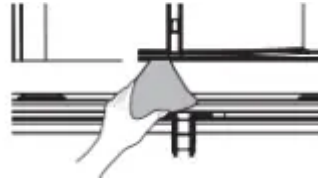

Cleaning the Exterior

Wipe the control panel and digital display with a damp, clean, soft cloth. Do not spray water directly on the surface of the refrigerator.

The doors, handles, and cabinet surfaces should be cleaned with a mild detergent and then wiped dry with a soft cloth. To keep your appliance looking its best, polish the exterior once or twice a year.



CAUTION: Do not spray water directly on the refrigerator. Use a clean, damp cloth to clean.

CAUTION: Do not use benzene, thinner, or Clorox for cleaning. They may damage the surface of the appliance and may cause a fire.

CAUTION: You can erase the printed letters on the display if you apply stainless cleaner directly to the area where the letters



Cleaning the Ice / Water Dispenser

Push down one end of the tray dispenser and remove it. Wipe the Ice / Water Dispenser with a clean, soft cloth.

CAUTION: When using the crushed ice selection from the dispenser some residual ice chips may start to collect in the ice chute. To prevent that residual ice from melting and running out of the chute, you should clean out the residual ice when you see it start to collect in the ice chute.



Cleaning the Rubber door seals

If the rubber door seals are dirty, the doors may not close properly, and the refrigerator will not operate efficiently. Keep the door seals free of dust or stains by cleaning the doors using a mild detergent and damp cloth. Wipe dry with a clean, soft cloth.

CAUTION: Do not clean the refrigerator with benzene, thinner, or car detergent. These substances could cause a fire.

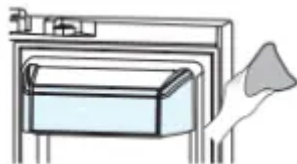

Cleaning the rear side of the refrigerator

To keep cords and exposed parts free of dust and dirt accumulation, vacuum the rear side of the appliance once or twice a year.

CAUTION: Do not remove the back cover (1). You could suffer an electric shock.

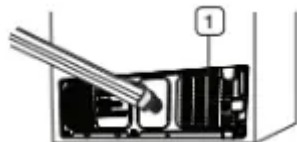

Troubleshooting

The refrigerator does not work at all or it does not chill sufficiently.

- Check that the power plug is properly connected.
- Check if the set temperature on the digital display is warmer than the freezer or fridge inner temperature. If it is, set the refrigerator colder.
- Is the refrigerator in direct sunlight or located near a heat source?
- Is the back of the refrigerator too close to the wall, preventing proper ventilation?

The food in the fridge is frozen.

- Check if the set temperature on the digital display is too low.
- Try setting the refrigerator to a warmer temperature.

- Is the temperature in the room too low? Set the refrigerator warmer.
- Did you store the food which is juicy in the coldest part of the refrigerator? Try moving those items to the other shelves in the fridge instead of keeping them in the colder areas or bins.

You hear unusual noise or sounds.

- Check that the refrigerator is level and stable.
- Is the back of the refrigerator too close to the wall, preventing proper ventilation?
- Try moving the back of the refrigerator at least 2 inches from the wall.
- Was anything dropped behind or under the refrigerator?
- A “ticking” sound is heard from inside the refrigerator. It is normal and occurs because various accessories are contracting or expanding according to the temperature of the refrigerator interior.
- If it sounds as if something is hitting something else inside the refrigerator, this is normal. The sound is caused by the compressor operating at high capacity.

The cabinet- door sealing area of the appliance is hot and condensation is occurring.

- Some heat is normal as anti-condensators are installed in the vertical hinged section of the refrigerator to prevent condensation.
- Is the refrigerator door ajar? Condensation can occur when you leave the door open for a long time.

Ice Maker is not producing ice.

- Did you wait for 12 hours after installing the water supply line before making ice?
- Is the water line connected and the shut-off valve opened?
- Did you manually stop the ice making function?
- Is the freezer temperature too warm? Try setting the freezer temperature lower.

You can hear water bubbling in the refrigerator.

- This is normal. The bubbling comes from refrigerant circulating through the refrigerator.

There is a bad smell in the refrigerator.

- Check for spoiled food.
- Foods with strong odors (for example, fish) should be tightly covered.
- Clean out your freezer periodically and throw away any spoiled or suspicious food.

Frost forms on the walls of the freezer.

- Is the air vent blocked? Remove any obstructions so air can circulate freely.
- Allow sufficient space between the stored food for efficient air circulation.

- Is the freezer drawer closed properly?

Water dispenser is not functioning.

- Is the water line connected and the shut-off valve opened?
- Has the water supply line tubing been crushed or kinked?
- Make sure the tubing is free and clear of any obstruction.
- Is the water tank frozen because the fridge temperature is too low?
- Try selecting a warmer setting on the Digital display.
- Is the Child Lock on?

Auto close system does not work with the freezer door.

- Is there an imbalance between the right and left parts of the door?
- Open and close the door smoothly 1~2 times. After you do this, the auto close system usually works properly again.
- Try opening the door smoothly to avoid unbalancing the right part and the left part of the door.

Condensation or water drops forms on both sides of fridge door's central part.

- Condensation or water drops may form if the humidity is too high while the refrigerator is operating.
- If condensation or water drops appears on both sides of fridge door's central part, turn the Energy Saver mode off after removing the condensation. See the explanation on Energy Saver button in the USING THE CONTROL PANEL.)

Warning

This content is compiled from multiple sources and is provided for reference purposes only. It may not be complete or fully applicable to all situations. If you are unable to resolve your issue, please contact the product manufacturer or an authorized service provider for official support.