

Quick reference: home use

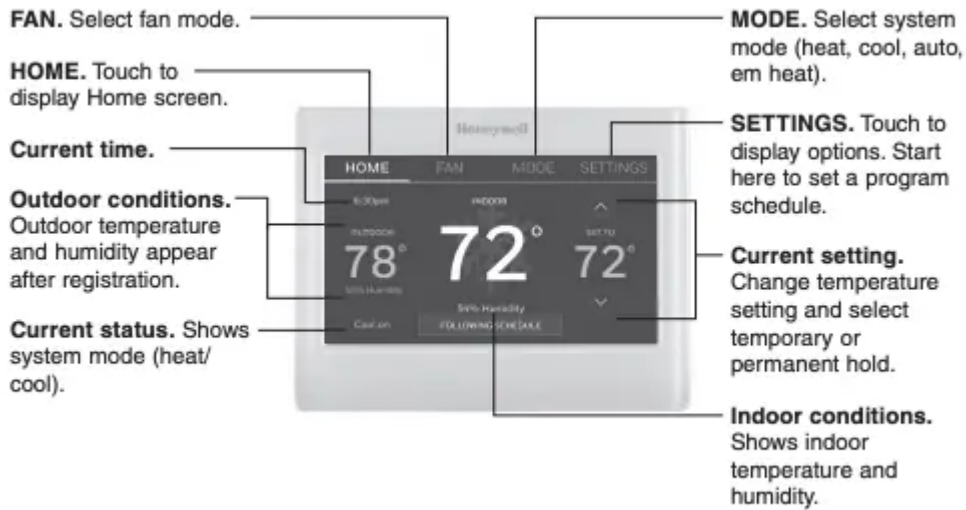

Quick reference: business use

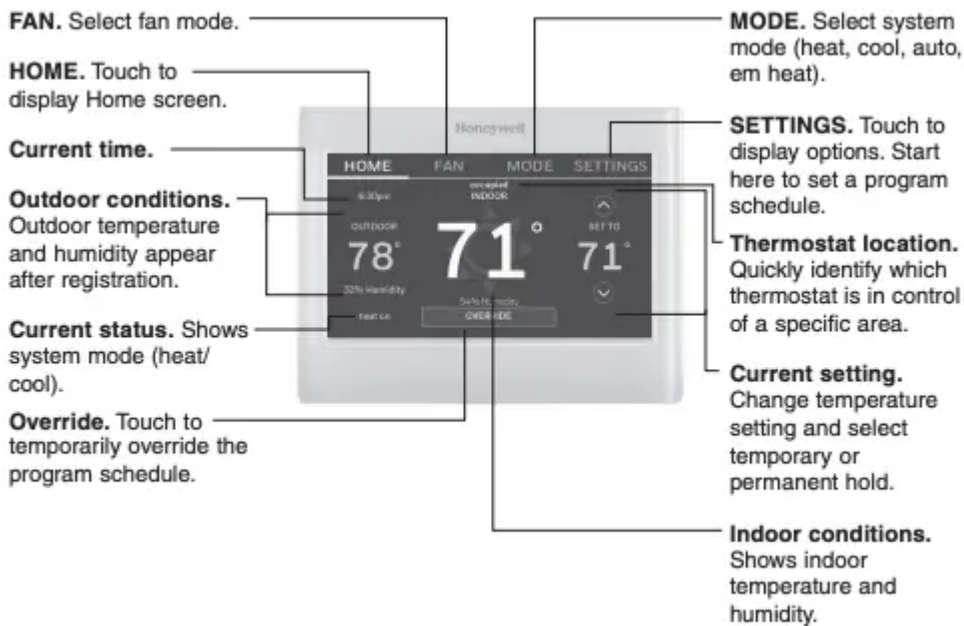

Setting up your thermostat

Setting up your Wi-Fi programmable touchscreen thermostat is easy. It is preprogrammed and ready to go as soon as it is installed and registered.

- ① Install your thermostat.

- ② Connect it to your home wireless network.
- ③ Register online for remote access.



Before you begin, you may want to watch a brief installation video. Use the QR Code® at the front of this guide, or go to wifithermostat.com/support

Installing your thermostat

You might need the following tools to install this thermostat:

- No. 2 Phillips screwdriver
 - Pen
 - Pencil
 - Level (optional)
 - Drill and bits (3/16" for drywall, 7/32" for plaster) (optional)
 - Hammer (optional)
 - Electrical tape (optional)
- 1 Switch OFF power to your heating/cooling system. Important! To protect your equipment, switch OFF the power to your heating/cooling system at the breaker box or the system switch.

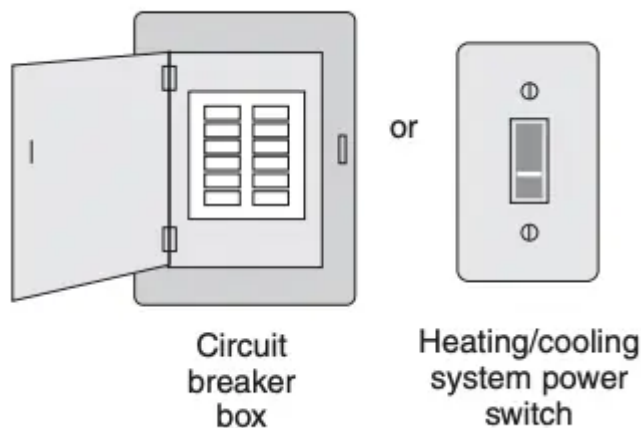

- 2 Remove old thermostat faceplate and leave wires connected.



2a Take a picture of the wire connections for later reference.



2b If no wire is connected to a terminal labeled C or no C terminal exists on the old thermostat, view the Alternate Wiring videos at wifithermostat.com/videos or reference the C-wire addendum in the box.

Important! C wire is required and is the power source for your thermostat. Without a C wire, your thermostat will not power up



thermostat.

Note: You will need a picture of your wire connections to wire the new

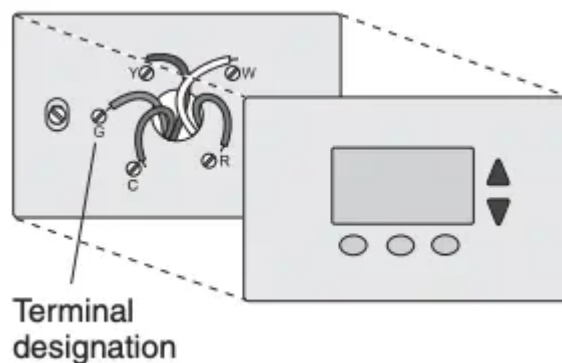

If you have an older thermostat with a sealed mercury tube, turn to page ii for proper disposal instructions.

- 3 Label the wires. Use the supplied sticky tags to label each wire as you disconnect it. Label wires according to the old thermostat terminal designations, not by wire color.

Note: If no tag matches a terminal designation, write the appropriate letter on a blank sticky tag.

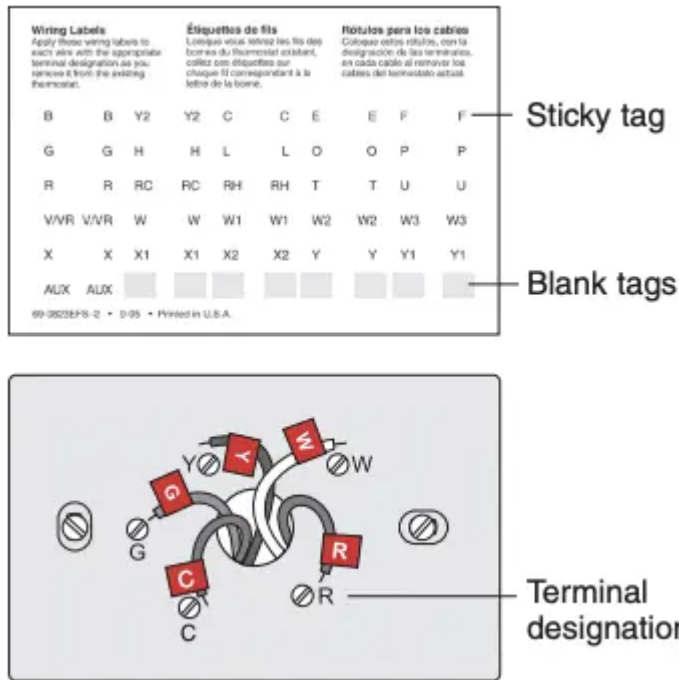

- 4 Remove wallplate. Remove the old wallplate from the wall after all wires have been labeled and disconnected.

Note: Wrap the wires around a pencil to prevent them from falling back into the wall

- 5 Mount wallplate for Wi-Fi thermostat. Mount your new wallplate using screws and anchors included with the thermostat. If necessary: Drill 3/16-in holes for drywall. Drill 7/32-in holes for plaster.

Note: You may be able to use your existing wall anchors. Hold the wallplate up to the existing anchors to check for alignment.

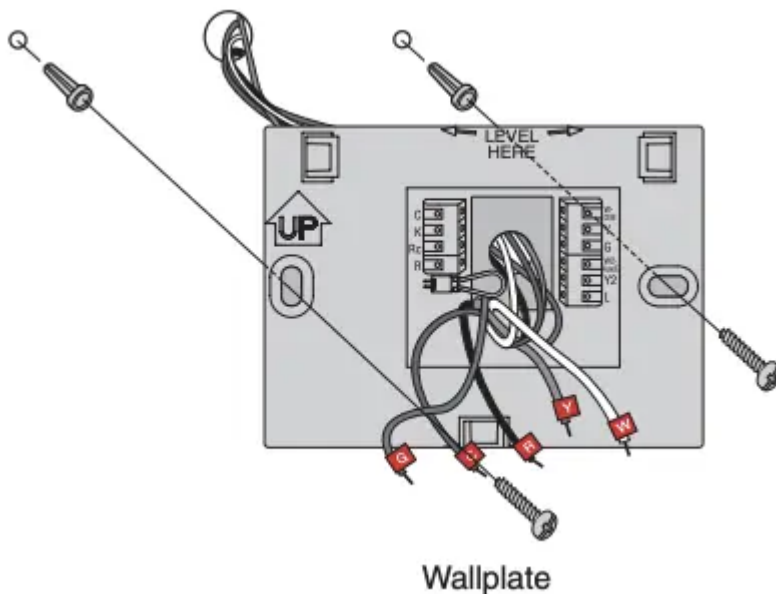

Important! This thermostat requires a C, or common, wire for power. The C, or common, wire brings 24 VAC power to the thermostat. If you are replacing an existing thermostat, it might not

have a C wire connected to it. Many older mechanical or battery operated thermostats do not require a C wire. See the C Wire Addendum document included in this package for more information. If you don't have a C wire, try:

Note: Not all heating/cooling systems label the 24 VAC common C. Check your system manual or contact the manufacturer to find out which terminal is the 24 VAC common.



View the Alternate Wiring videos at wifithermostat.com/videos

Wiring

For conventional heating/cooling systems (natural gas, oil or electric furnace, air conditioner), see page 5. See “Glossary” on page 33 for further definition. For a heat pump system, see page 6. See “Glossary” on page 33 for further definition.

Wiring (Conventional System)

- 6A Wire the Wi-Fi thermostat to your conventional system.
- a Starting with the C Wire, match the sticky tag on the wire to the terminal labels. You must have a C wire.
- b Straighten wire and gently slide into terminal hole until it clicks into place. (If you need to remove a wire, use a pen tip to press the terminal release and then pull wire out.)

Note: Refer to the wiring picture you took in Step 2.

Tip: To make it easier to slide the wire into place, use a pen tip to hold down the terminal release.

Note: The wiring for your application might be different than the wiring shown below.

Terminal release

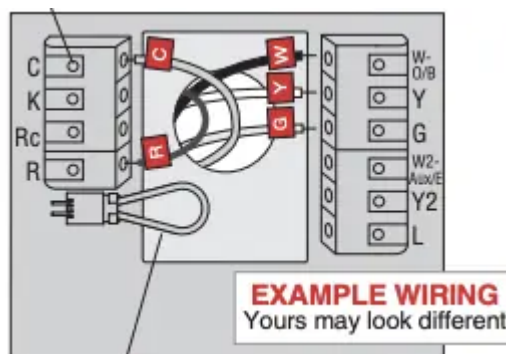

Remove jumper loop ONLY if you have both R and Rc wires.

- c In the image on the right, check the box next to each connection. You will use this checklist in Step 9.
- d Verify wire is firmly secured by gently pulling on wire.
- e Repeat steps a–d for all other wires.

- f Push any excess wire back into the wall opening after all wires are installed.
- g Continue to page 8.

Wiring (Heat Pump System)

- 6B Wire Wi-Fi thermostat to your heat pump.
- a Starting with the C Wire, match the sticky tag on the wire to the terminal labels. You must have a C wire. See page 5.
- b Slide wire gently into terminal hole until it clicks into place. (If you need to remove a wire, use a pen tip to press the terminal release and then pull the wire out.)

Note: Refer to the wiring picture you took in Step 2.

Tip: To make it easier to slide the wire into place, use a pen tip to hold down the terminal release.



Important! Check the box for each wire you connect. You will need this information in Step 9.

C	<input type="checkbox"/>	<input type="checkbox"/>	W-O/B
K	<input type="checkbox"/>	<input type="checkbox"/>	Y
Rc	<input type="checkbox"/>	<input type="checkbox"/>	G
R	<input type="checkbox"/>	<input type="checkbox"/>	W2-Aux/E
		<input type="checkbox"/>	Y2
		<input type="checkbox"/>	L

Note: The wiring for your application might be different than the wiring shown below.

Terminal release

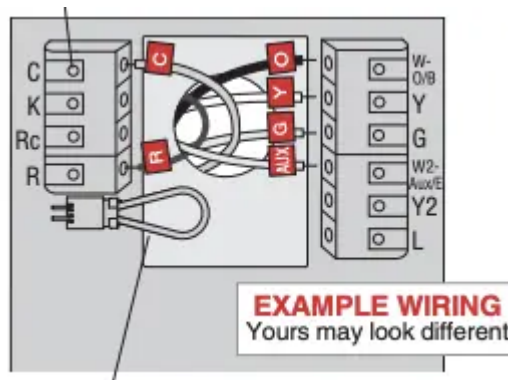

Remove jumper loop ONLY if you have both R and Rc wires.

- c In the image on the right, check the box next to each connection. You will use this checklist in Step 9.
- d Verify wire is firmly secured by gently pulling on wire.

- e Repeat steps a–d for all other wires.

Note: If old thermostat has separate wires on AUX and E, use a wire nut to attach both wires to a separate wire. Slide this third wire into the W2-Aux/E terminal.

- f Push any excess wire back into the wall opening after all wires are installed. g Continue to page 8.



Important! Check the box for each wire you connect. You will need this information in Step 9.

C	<input type="checkbox"/>	W-O/B	<input type="checkbox"/>
K	<input type="checkbox"/>	Y	<input type="checkbox"/>
Rc	<input type="checkbox"/>	G	<input type="checkbox"/>
R	<input type="checkbox"/>	W2-Aux/E	<input type="checkbox"/>
		Y2	<input type="checkbox"/>
		L	<input type="checkbox"/>

Alternate wiring (Conventional System)

Use this if your wire labels don't match the terminal labels.

Note: You must have a C wire or equivalent. See page 5.

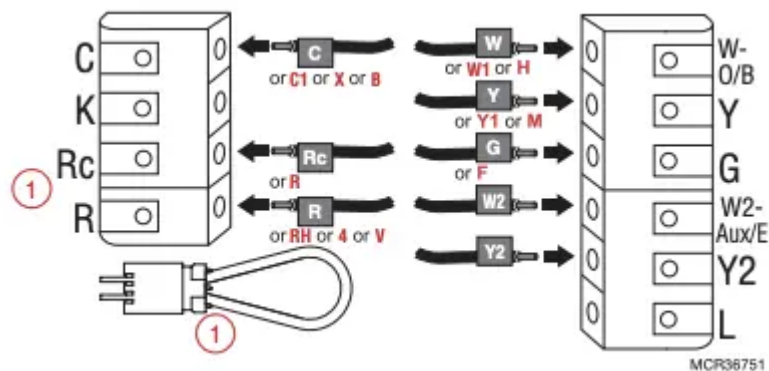

Alternate wiring key (Conventional System)

- 1 • If you have both an R and Rc wire, unplug the jumper loop by pulling on the wire loop.
- If your old thermostat had both R and RH wires, connect the R wire to the Rc terminal, the RH wire to the R terminal, and unplug the jumper loop.

Alternate wiring (Heat Pump System)

Use this if your wire labels don't match the terminal labels.

Note: You must have a C wire or equivalent. See page 5.

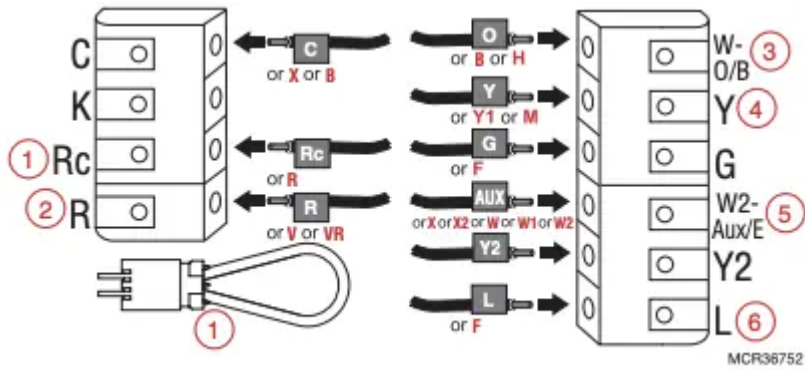

Alternate wiring key (Heat Pump System)

- ① If you have both an R and Rc wire, unplug the jumper loop by pulling on the wire loop. If your old thermostat had both R and RH wires, connect the R wire to the Rc terminal, the RH wire to the R terminal, and unplug the jumper loop.
- ② If your old thermostat had both V and VR wires, check wifithermostat.com for help.
- ③ If your old thermostat had separate O and B wires, and is controlling a single zone heat pump system, attach the B wire to the C. If there is more than one thermostat controlling the system, call Honeywell zoning at 800-828-8367 for wiring assistance.
- ④ If your old thermostat had separate Y1, W1, and W2 wires, check wifithermostat.com for help.
- ⑤ If the old thermostat has separate wires on Aux and E, use a wire nut to attach both wires to a separate wire. Slide this third wire into the W2-Aux/E terminal.
- ⑥ This is the system monitor. If the monitor finds a problem, you will see an orange alert button on the thermostat home screen.
- 7 Attach thermostat to wallplate. Align the thermostat with the wallplate and then snap into place.

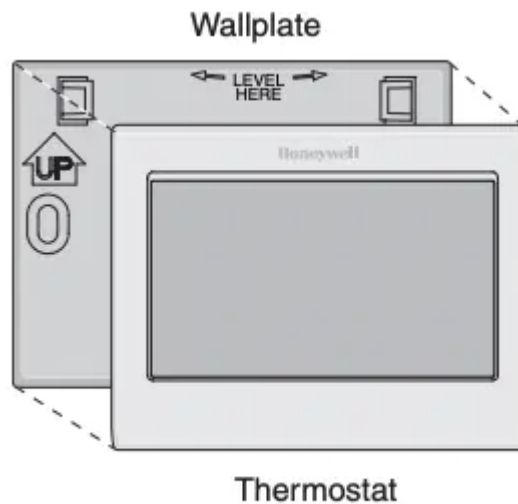

- 8 Switch heating/cooling system ON.

Important!

- 8a Verify that the C wire is connected at the thermostat and at the heating/cooling system.
- 8b Make sure the heating/cooling system door is firmly secured.
- 8c Switch power back ON for your heating/cooling system at the breaker box or its power switch.

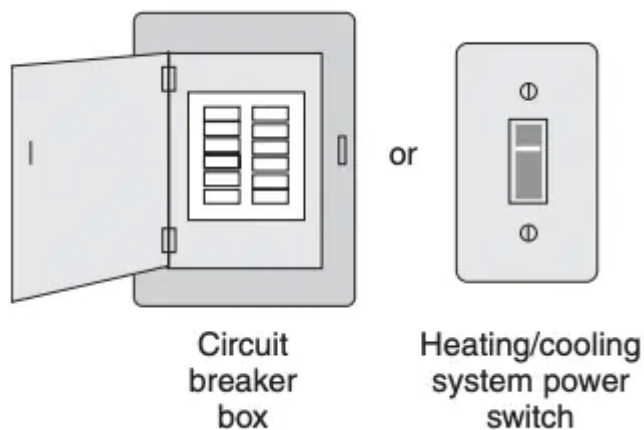

Before connecting to your Wi-Fi network, you need to set initial thermostat options to define your heating/cooling system:

- Language
- Home or business You can customize other options later.
- 9 Follow prompts on the screen to select appropriate options.

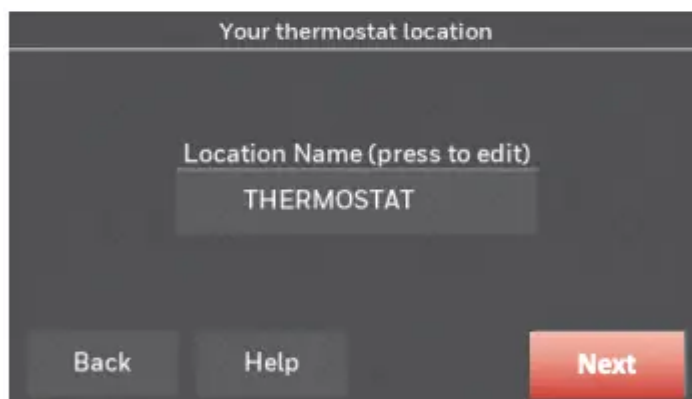
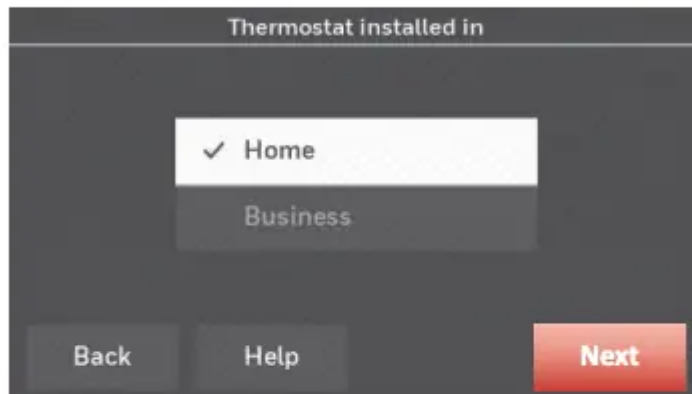
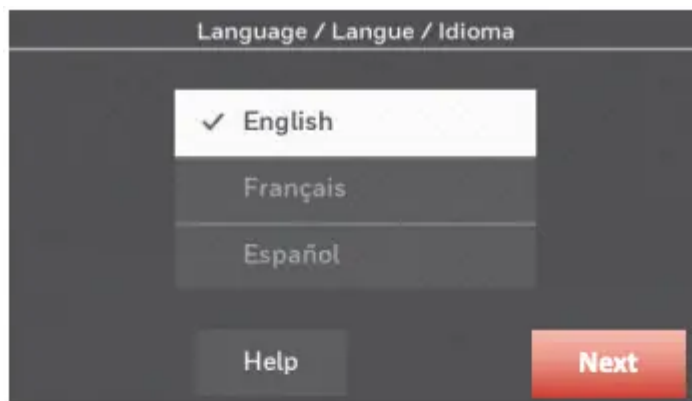

- 9a Touch the language you want the thermostat to display, then touch Next.
- 9b Select Home or Business installation, then touch Next.

- 9c Touch Next, or name the thermostat location—touch THERMOSTAT and follow the rest of the instructions.
- 9d Select what type of heating and cooling equipment your thermostat will control and touch Next.

Note: Touch the orange Help button on any screen for more information.

- 9e Select your system type and touch Next. The system type determines other selections for completing initial setup. Use the checklist from Step 6A-d when making selections.
- 9f Touch Next after making selections on each screen.
- 9g Touch Done on the last screen. The thermostat displays an option to connect to your Wi-Fi network.

Note: Touch the orange Help button on any screen for more information.



Connecting to your Wi-Fi network

After touching Done on the final screen of the initial set up, the thermostat displays an option to connect to your Wi-Fi network.

- 1 Connect the Wi-Fi network. Touch Yes to connect the thermostat to your Wi-Fi network. The screen displays the message "Searching for wireless networks. Please wait..." after which it displays a list of all Wi-Fi networks it can find.

Note: If you cannot complete this step now, touch I'll do it later. The thermostat will display the home screen. Complete this process by selecting SETTINGS > Wi-Fi Setup. Continue with Step 2.

- 2 Select the network.
- 2a Touch the name of the network you want to use. The thermostat displays a password page.

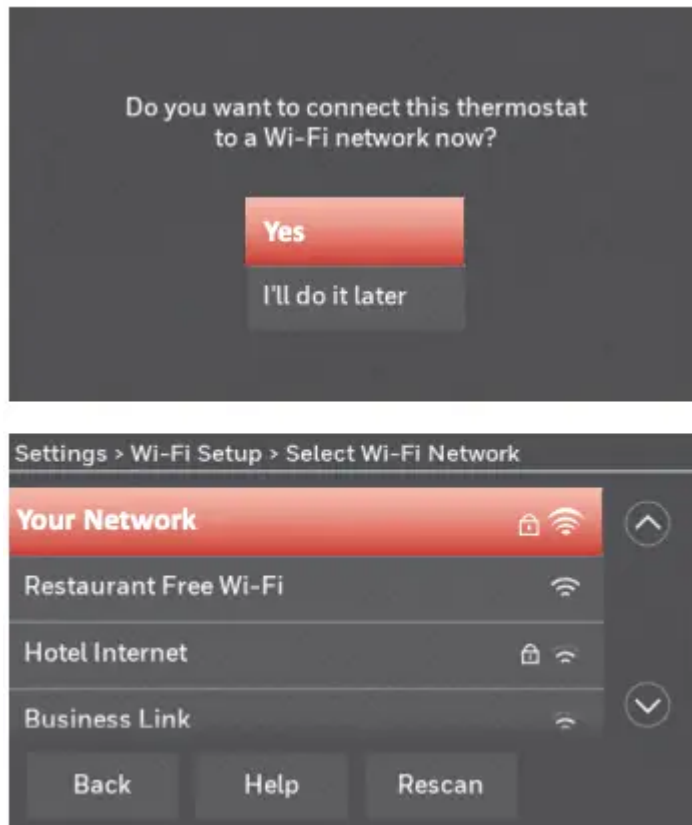

Note: If your home network is not shown on the list, touch Rescan.

- 2b Using the keyboard, touch the characters that spell out your home network password.
- 2c Touch Done. The thermostat displays “Connecting to your network. Please wait...” then shows a “Connection Successful” screen.
- 2d Touch OK to display the registration information screen.
- 2e Note your Thermostat MAC and Thermostat CRC. You need these numbers to complete online registration.

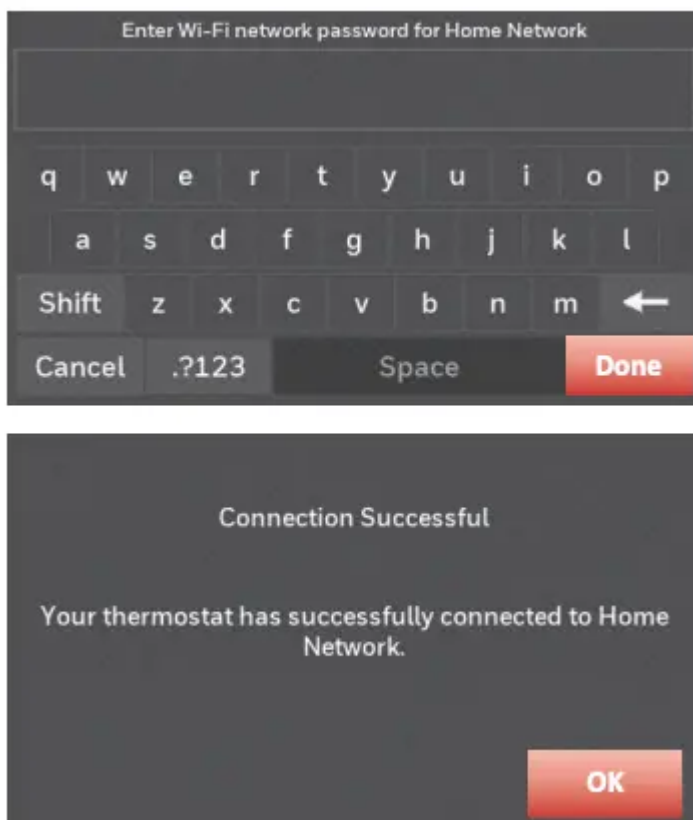

To register your thermostat, follow the instructions beginning on page 13.

Note: The Register Online screen remains active until you complete registration and/or touch Done.

Note: If you touch Done before you register online, your home screen displays an orange alert button telling you to register. Touching that button displays registration information and an option to snooze the task.

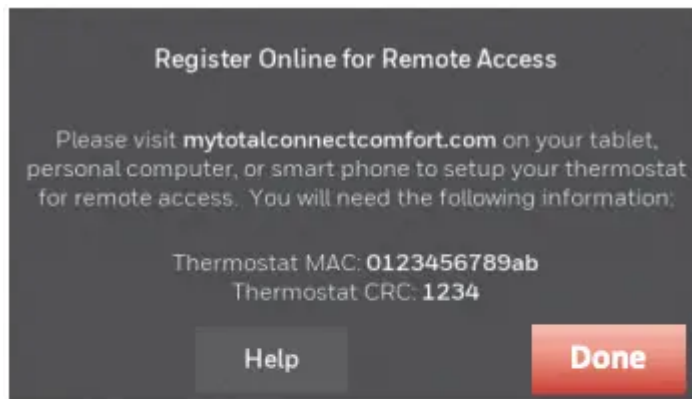

Disconnecting your Wi-Fi network

- 1 Touch SETTINGS.
- 2 Select Wi-Fi Setup.
- 3 Touch Disconnect from Network. The thermostat will display a question to confirm your selection.
- 4 Touch Yes to confirm that you want to disconnect from the network. The thermostat will display the Wi-Fi Setup screen.
- 5 Touch OK to display the menu.

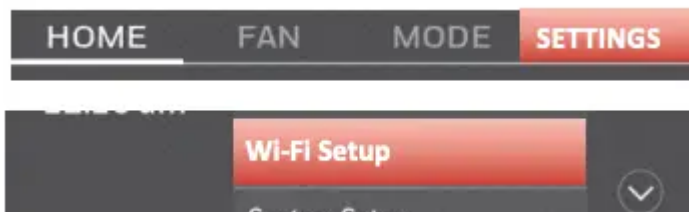

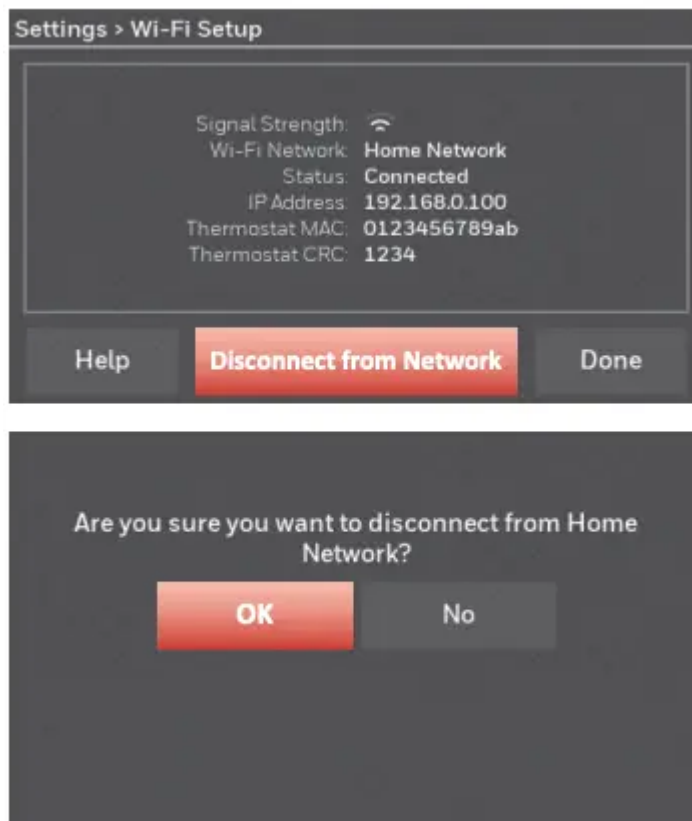

Reconnecting your Wi-Fi network

- 1 Touch SETTINGS.
- 2 Select Wi-Fi Setup.
- 3 Touch the name of the network you want to use. The thermostat may display a password page.
- 4 To enter a password, touch characters to spell out your home network password, then touch Done.
- 5 The thermostat displays "Connecting to your network. Please wait..." then a "Connection Successful" screen.
- 6 Touch Next.
- If your thermostat is registered, you will see your signal strength and other status information. Touch Done.
- If the screen displays "Register Online for Remote Access," follow instructions on page 13.



Setting the time/date

- 1 Touch the current time. The screen displays Set Time/Set Date.
- 2 Touch Set Time or Set Date.
- 3 Touch ▲ or ▼ until the proper time/date is displayed.
- 4 Touch Done to save or Cancel to ignore changes.

Note: This thermostat will automatically update for daylight saving time (if observed in your area) and all date/time information is stored. If the thermostat is connected to Wi-Fi and registered to Total Connect Comfort, the current time is updated from the internet.

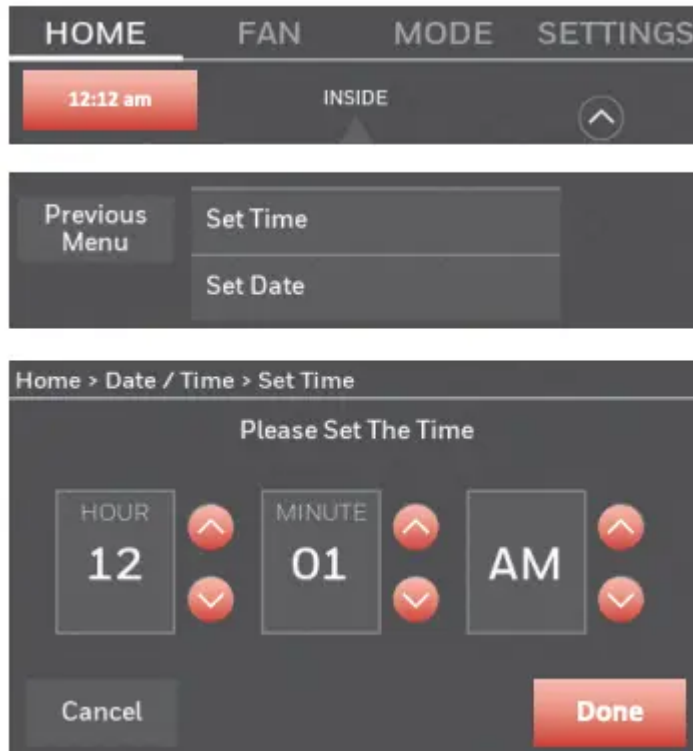

Setting the fan

- 1 Touch FAN to display fan settings.
- 2 Touch On, Automatic, Circulate, or Follow Schedule.

Note: Follow Schedule option only appears if the fan is set for On or Circulate for one or more program periods.

- 3 Touch Done to save and exit.

On: Fan is always on.

Automatic: Fan runs only when the heating or cooling system is on.

Circulate: Fan runs randomly about 35% of the time (home use only).

Follow Schedule: Follow Schedule is not an option if all programs are set to fan auto (see pages 16-18).

Note: Touch On, Automatic, or Circulate to temporarily override the programmed fan schedule.



Setting system mode

- 1 Touch MODE to display system settings.
- 2 Touch desired option: Heat: Thermostat controls only the heating system.

Cool: Thermostat controls only the cooling system.

Off: Heating/cooling systems are off.

Automatic: Thermostat selects heating or cooling as needed depending on the indoor temperature.

Emergency Heat (heat pumps with aux. heat): Controls auxiliary/emergency heat. Compressor is locked out.

- 3 Touch Done to save and exit.

Note: The Automatic and Emergency Heat system settings may not appear, depending on how your thermostat was installed. See “Auto changeover” on page 26.

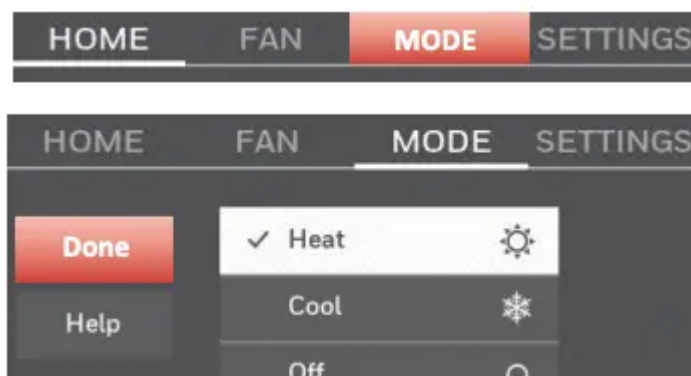

Preset energy-saving schedules

This thermostat uses default Energy Saver settings that can reduce your heating/ cooling expenses. To customize settings, see next page.

Home Use

Period	Start time	Heat (Mon-Fri)	Cool (Mon-Fri)	Heat (Sat-Sun)	Cool (Sat-Sun)
Wake	6:00 am	70°	78°	70°	78°
Leave	8:00 am	62°	85°	62°	85°
Return	6:00 pm	70°	78°	70°	78°
Sleep	10:00 pm	62°	82°	62°	82°

Business Use

Period	Start time	Heat	Cool	Fan
Occupied 1	8:00 am	70°	75°	On
Unoccupied 1	10:00 pm	55°	85°	Auto
Occupied 2*	12:00 am	70°	75°	On
Unoccupied 2*	12:00 am	55°	85°	Auto

* Period 2 is cancelled by default. If you activate it, the values shown above are default settings.

Adjusting program schedules

- 1 Touch SETTINGS.
- 2 Select Create/Edit Schedule.
- Touch View/Edit to view the full schedule and make a quick adjustment.
- Touch Guide Me to create a schedule by answering simple questions.
- Touch I'll do it myself to manually create a program schedule.

Note: To reduce costs, use the pre-set Energy Saver settings described on page 16.

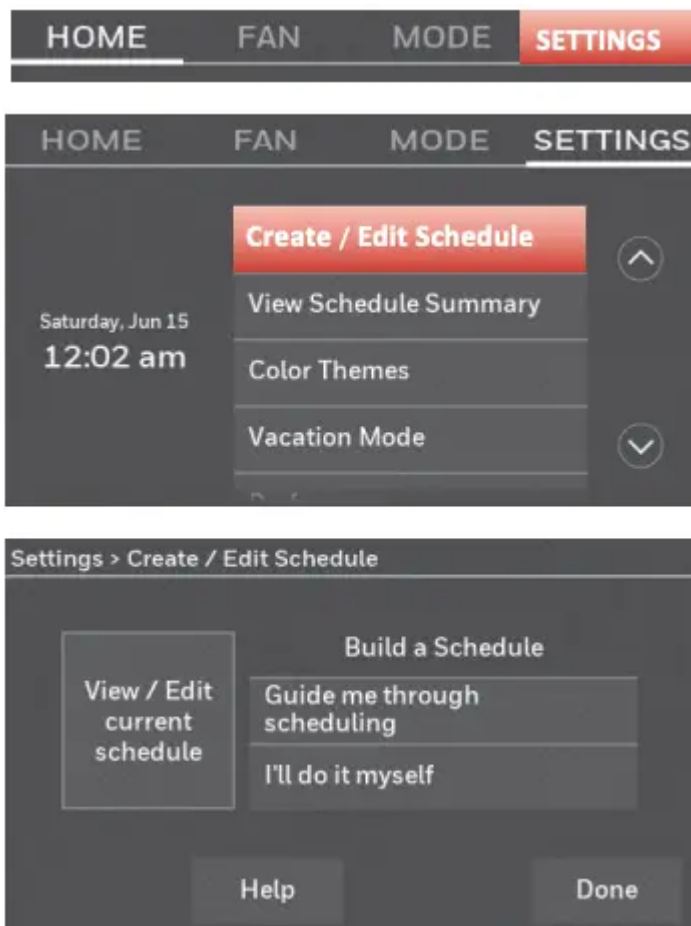

If you selected I'll do it myself on the Create/ Edit Schedule screen follow these steps:

- 1 Select the days to schedule, touch Next.
- 2 Touch Wake to set your Wake time for selected days.

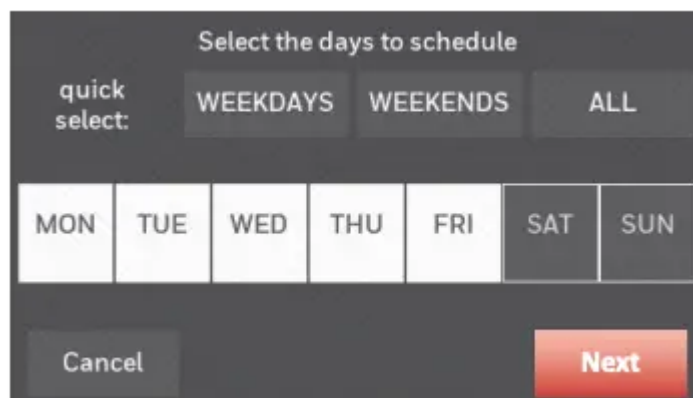

- 3 Touch ▲ or ▼ to set Heat and Cool temperatures for the Wake period, then touch Done.
- 4 Touch other time periods (Leave, Return, Sleep) to set time and temperatures for each.
- 5 Touch Done to save and exit. Note: Touch Delete Period to eliminate any unwanted time period.

Note: Touch Fan Settings to customize fan settings for any time period.

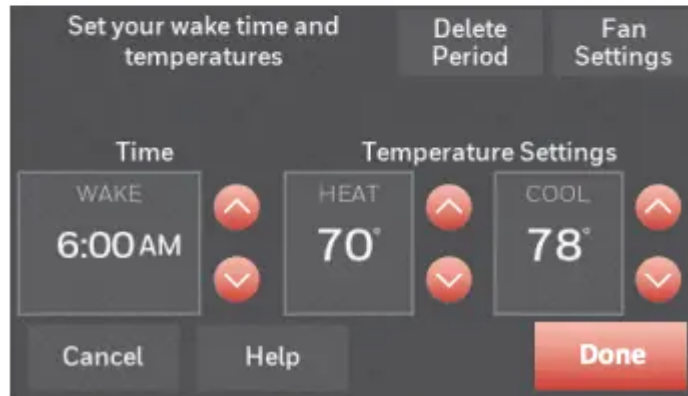

Overriding schedules: home use

- 1 Touch ▲ or ▼ to adjust the temperature (right side of screen) and the Hold Until time. The schedule will resume when the Hold Until time expires.
- 2 Touch Permanent to keep the same temperature until you change it or resume the program schedule.
- 3 Touch Cancel Hold at any time to resume the program schedule.

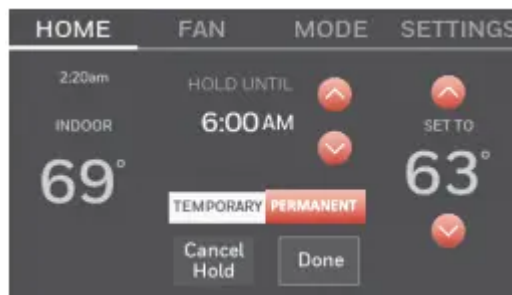

Overriding schedules: business use

Touch ▲ or ▼ to adjust the temperature. It will be maintained until the hold time you set.

- To change the hold time, touch the Hold Until arrow buttons. This time can be adjusted up to the maximum time set on the Override Duration screen in Advanced Preferences (page 27).

- Touch Override to use a pre-set occupied temperature if a person uses the room during an unoccupied period. The new temperature will be maintained for 1 hour and can be adjusted up to the maximum time set on the Override Duration screen in Advanced Preferences (page 27).

The programmed schedule will resume when the override timer expires. Touch Cancel Hold at any time to resume the program schedule.



Viewing equipment status

- 1 Touch SETTINGS.
- 2 Select Equipment Status.
- 3 Touch ▲ or ▼ to view the status of all the equipment your thermostat is controlling. Depending on how your thermostat was installed, the Equipment Status screen can report data about the following systems:
 - Heating and cooling
 - Fan
 - Thermostat information

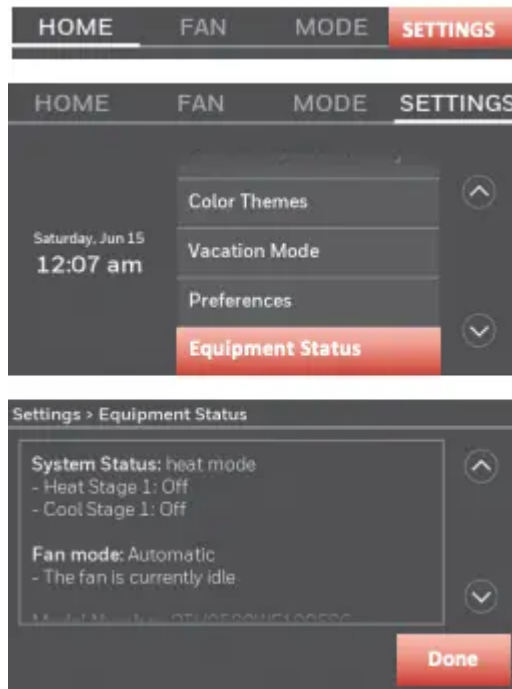

Setting vacation hold: home use

This feature helps you save energy while you are away, and restores comfortable settings just before you return home.

- 1 Touch SETTINGS.
- 2 Select Vacation Mode.
- 3 Touch ▲ or ▼ to select the date you leave, then touch Next for further scheduling details, including times of day, temperature settings, return date, and return settings.
- 4 Review your selections on the last display, and touch Done to save your settings. Touch Back, then Cancel to ignore the changes.



Setting holiday/event schedules: business use

This feature helps you conserve energy when the workplace is unoccupied for special events and holidays.

- 1 Touch SETTINGS.
- 2 Select Holiday/Event Scheduler.
- 3 Select the item you want to schedule.
 - Custom Events lets you set up other days for special schedules.
- US and Canadian Holiday options let you select from a list of holidays commonly observed in each country.
 - 4 Make selections as prompted on each screen. For more information, see next two pages.
 - 5 Touch Done to save your settings.

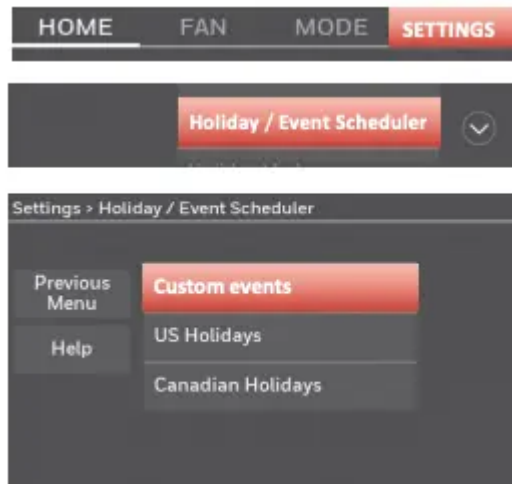

Setting custom events: business use

This feature lets you customize temperature settings to be maintained during a specific event. You can set up an event for a specific date or day in a month. The thermostat resumes normal scheduling after the event.

- 1 Touch SETTINGS.
- 2 Select Holiday/Event Scheduler.
- 3 Select Custom events from the Holiday/ Event Scheduler menu.
- 4 Select Create a new event.
- 5 Select Unoccupied or Occupied.

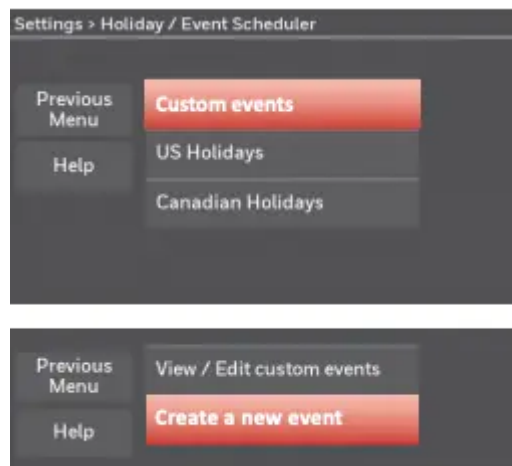

- 6 Select Specific Date or Month/Weekday.
- For Specific Date, you are prompted to select the start date, settings, end date, and frequency for the event.

- For Month/Weekday, you are prompted to select the month, day of the week, week of the month, settings, length of event, and frequency of the event.
- 7 Review the settings and touch Done to save them. Touch Back, then Cancel to ignore the changes.

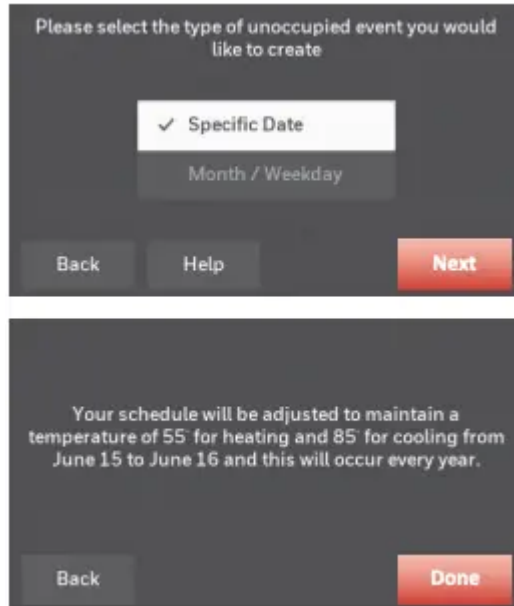

Setting holiday schedule: business use

This feature lets you customize temperature settings to be maintained on specified national holidays. The thermostat resumes normal scheduling between selected holidays.

- 1 Select US Holidays or Canadian Holidays from the Holiday/Event Scheduler menu.
- 2 Select Add/Edit Holidays. A list of national holidays is displayed.
- 3 Touch the check box next to each holiday for which you want to maintain specific settings, (Touch p or q to scroll through the holiday list.) then touch Next. Set the holiday schedule for Occupied or Unoccupied temperatures, depending whether the building will be in use.
- 4 Touch ▲ or ▼ to select the Heat and Cool temperatures.
- 5 Review the settings and touch Done to save them. Touch Back, then Cancel to ignore the changes

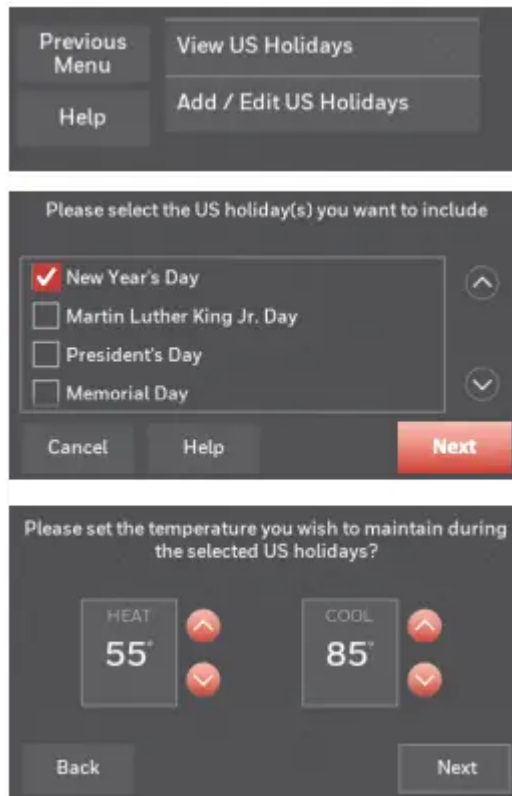

Setting holiday schedule: business use

This feature lets you customize temperature settings to be maintained on specified national holidays. The thermostat resumes normal scheduling between selected holidays.

- 1 Select US Holidays or Canadian Holidays from the Holiday/Event Scheduler menu.
- 2 Select Add/Edit Holidays. A list of national holidays is displayed.
- 3 Touch the check box next to each holiday for which you want to maintain specific settings, (Touch ▲ or ▼ to scroll through the holiday list.) then touch Next. Set the holiday schedule for Occupied or Unoccupied temperatures, depending whether the building will be in use.
- 4 Touch ▲ or ▼ to select the Heat and Cool temperatures.
- 5 Review the settings and touch Done to save them. Touch Back, then Cancel to ignore the changes.

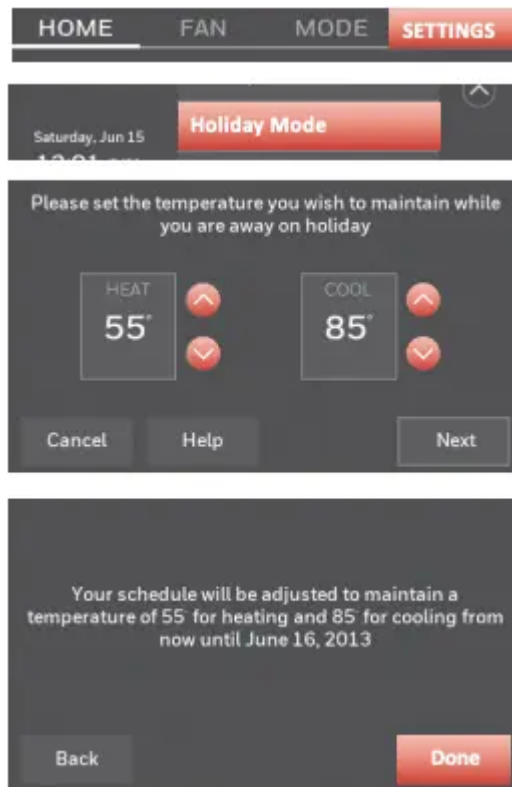

Customizing screen color

You can customize your thermostat display to match your décor.

- 1 Touch SETTINGS.
- 2 Touch Color Themes.
- 3 Select the name of a color to use a predefined background, or select Custom to define your own background color and text.
- If you select a color name, the screen shows an example on the left. Touch Done to accept that selection.
- If you touch Custom, the screen gives you instructions. Touch Next to step through the choices; touch Done when you are satisfied with your changes.

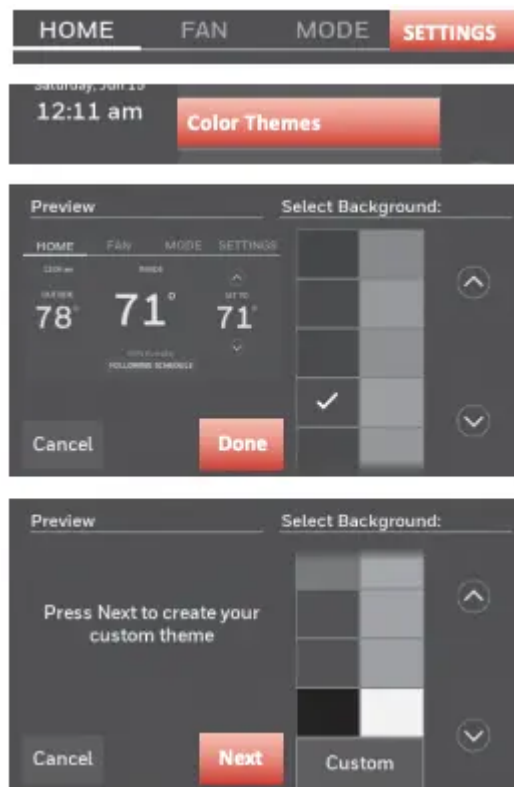

Setting preferences

Preference menu options let you select how the thermostat displays information or responds to certain situations.

- 1 Touch SETTINGS and select Preferences.
- 2 Select an option and follow prompts:
 - Reminders
 - Utility Schedule Options
 - Backlight
 - Smart Response Technology
 - Advanced Preferences
 - Restore Default Schedule
 - Restore Factory Defaults
- 3 Touch Done to save your settings. Touch Cancel to ignore changes



Cleaning the thermostat screen

When you select the Clean Screen option, the screen is locked so you don't accidentally change settings while you clean.

- 1 Touch SETTINGS.
- 2 Select Clean Screen. A prompt asks if you want to clean the screen for 30 seconds.
- 3 Touch Yes. A countdown timer displays elapsed time until the screen is reactivated.

Note: Do NOT spray any liquid directly on the thermostat. Spray liquids onto a cloth, then use the damp cloth to clean the screen. Use water or household glass cleaner. Avoid abrasive cleansers.

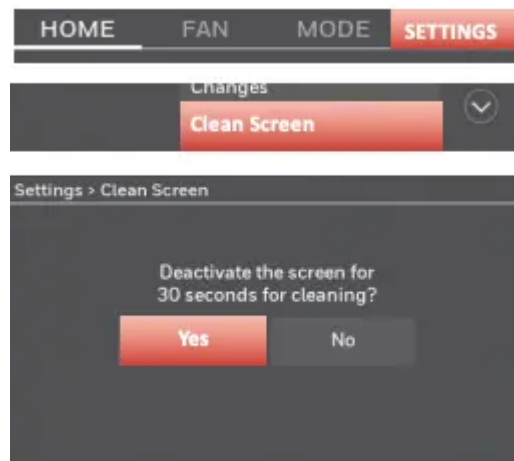

Adjusting security settings

You can adjust security options to prevent unauthorized changes to system settings.

- 1 Touch SETTINGS and select Security Settings.
- 2 Select Change Lock Mode.
- 3 Select an option and follow prompts:

Unlocked: Full access allowed.

Partially locked: Only temperature can be changed.

Fully locked: No access allowed.

Note: If you choose to use a password for additional security, write it here for reference:

--	--	--	--



Setting advanced preferences

You can change options for a number of system functions. Although many options, such as language and temperature indication settings are the same for all setups, others depend on the type of system you have.

- 1 Touch **SETTINGS**. The thermostat displays a list of options.
- 2 Select **Preferences > Advanced Preferences**. The thermostat displays the first screen of options that you can change.
- 3 On each screen, make changes as needed, then touch **Next** to display new options. Repeat this step until you have made all changes. Tables on pages 27-28 explain the screens and options under **Advanced Preferences**.
- 4 When you have made all changes, press **Done** to save and exit.

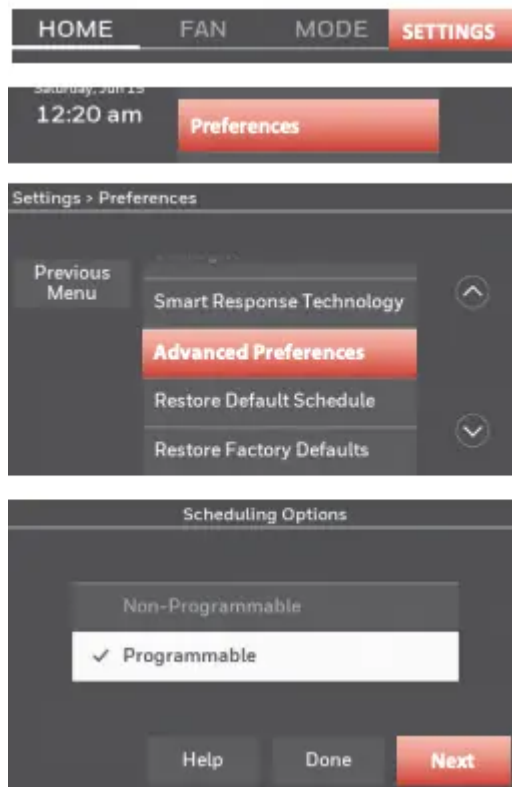

Advanced Preferences Options (SETTINGS > Preferences > Advanced Preferences)

Screen ---- Title Settings and Options (Options vary depending on setup.)

Scheduling Options --- Select Non-programmable or Programmable. Programmable uses default or customized programming to automatically raise and lower temperature settings for different times of day.

Temperature Indication Scale --- Select Fahrenheit or Celsius.

Heating and Cooling System Changeover --- Select Manual or Automatic.

Number of Schedule Periods --- Select 2 Periods Per Day or 4 Periods Per Day. (see page 16).

Pre-occupancy Purge Duration --- Select how long the fan will run before each occupied period: Off, 1, 2, or 3 hours.

Type of Override --- Select Standard to maintain the programmed periods or Initiate Occupancy to use energy-saving settings until a user presses Start Occupancy.

Override Duration --- Select how long to maintain temperature during an override: 1-10 hours or No Limit.

Advanced Preferences Options (concluded)

Screen Title --- Settings and Options (Options vary depending on setup.)

Early Recovery for Heating --- Select No to begin recovery on schedule or Yes to ramp up temperature early.

Early Recovery for Cooling --- Select No to begin recovery on schedule or Yes to ramp down temperature early.

Temperature Limits --- Select the Minimum Cool and Maximum Heat Limit.

Keypad Lockout --- Select Unlocked/Partially Locked/Locked.

Clock Format --- Select 12 Hour or 24 Hour.

Daylight Saving Time --- Select Off or On. If set to On, the system will automatically change time/date to account for daylight saving.

Indoor Display Offsets --- Select the number of degrees to offset indoor temperature or percentage to offset indoor humidity

Changing system setup

If your needs change, you can change the basic system settings you chose during thermostat installation (page 9).

- 1 Touch SETTINGS. The thermostat displays a list of options.
- 2 Select System Setup. The thermostat displays the first screen of options that you can change.
- 3 On each screen, make changes as needed then touch Next to display new options. Repeat this step until you have made all changes. Table on page 29 explain the System Setup screens and options.
- 4 When you have made all changes, press Done to save and exit.

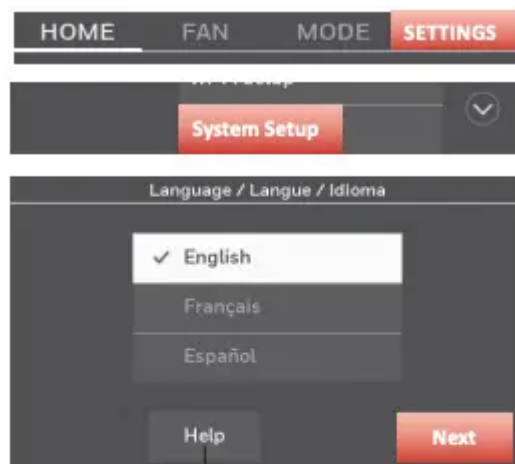

Touch the Help button to see information about screen options.

Note: Touch the orange Help button on any screen for more information

System Setup Options (SETTINGS > System Setup)

Screen Title --- Settings and Options (Options vary depending on setup.)

- Language -- English/Français/Español.
- Thermostat installed in -- Home/Business (Thermostat is used in a residential (default) or commercial setting).
- Your thermostat location -- Touch THERMOSTAT button to display a screen where you can enter a custom name using a keypad. If you have only one thermostat, you can leave the name as THERMOSTAT. For business installations you can check a box to display the thermostat name on the home screen.
- Your thermostat controls -- Select Heating or Cooling or both (default).
- Your system type -- Select Forced Air (default), Heat Pump, or Hot Water or Steam. Each option offers different choices on the following screens. See Step 9e under Installing your Thermostat on page 10.
- Your forced air heating system type -- Select type of furnace. This menu option only appears if Forced Air is selected for “Your System Type”.
- Efficiency of your heating system -- Select Standard Efficiency Forced Air (default) or High Efficiency Forced Air.
- Your heating system type -- If you selected Hot Water or Steam on “Your system type,” select the specific heating system here.
- Number of cooling stages -- Select 1 Stage (default) or 2 Stages. If you are unsure, note which wires you have connected: ‘Y’ wire only (1 stage) or ‘Y’ and ‘Y2’(refer to your check list in Step 6 on page 5.) Number of cool stages does not appear if “Heat Pump” is selected or cool stages is set to “0”.
- Number of heating stages -- Select 1 Stage (default) or 2 Stages. If you are unsure, note which wires you have connected: ‘W’ wire only (1 stage) or ‘W’ and ‘W2’ (refer to your check list in Step 6 on page 5.) Number of heat stages only appears if Forced Air” is selected for “Your System Type”.
- Your fan control -- Select whether your thermostat (default) or heating system controls the fan. Your fan control only appears if “Electric” is selected for “Your Forced Air Heating System Type”.
- Type of changeover valve -- If you selected Heat Pump on “Your system type,” select whether it uses a cooling changeover valve (default) or heating changeover valve. f you are unsure, note which wires you have connected: refer to your check list in Step 6 on page 6.
- Number of heat pump compressor stages -- Select 1 Stage (default) or 2 Stages. If you are unsure, note which wires you have connected: ‘Y’ wire only (1 stage) or ‘Y’ and ‘Y2’(refer to your check list in Step 6 on page 6.).

- Your backup heat -- No or Yes (default) you can determine whether you have backup heat by referring to your check list in Step 6 on page 6. Your backup heat only appears if “Your System Type” is set to Heat Pump

Troubleshooting

If you have difficulty with your thermostat, please try the following suggestions. Most problems can be corrected quickly and easily

Display is blank

- Check circuit breaker and reset if necessary.
- Make sure power switch at heating and cooling system is on.
- Make sure furnace door is closed securely.
- Make sure C wire is connected (see page 5).

Cannot change system setting to Cool

- Check that System Setup screen “Your thermostat controls” or “Your system type” is set to match your heating and cooling equipment (see page 29).

Fan does not turn on when heat is required

- Check that System Setup screen “Your fan control” is set to match your heating equipment (see page 28).

“Wait” appears on the screen

- Compressor protection feature is engaged. Wait 5 minutes for the system to restart safely, without damage to the compressor.

Heat pump issues cool air in heat mode, or warm air in cool mode

- Check your setting for System Setup screen “Type of changeover valve” to make sure it is properly configured for your system (see page 28).

Heating or cooling system does not respond

- Touch MODE to set system to Heat. Make sure the temperature is set higher than the Inside temperature.
- Touch MODE to set system to Cool. Make sure the temperature is set lower than the Inside temperature.
- Check circuit breaker and reset if necessary.
- Make sure power switch at heating and cooling system is on.
- Make sure furnace door is closed securely.

- If “Wait” is displayed, the compressor protection timer is on. Wait 5 minutes for the system to restart safely, without damaging the compressor (see page 26).

Heating system is running in cool mode

- Check that System Setup screen “Your thermostat controls” or “Your system type” is set to match your heating and cooling equipment (see “System Setup Options (SETTINGS > System Setup)” on page 29).

Warning

This content is compiled from multiple sources and is provided for reference purposes only. It may not be complete or fully applicable to all situations. If you are unable to resolve your issue, please contact the product manufacturer or an authorized service provider for official support.