

WHAT'S NEW UNDER THE LID?

Cleaning with Less Water

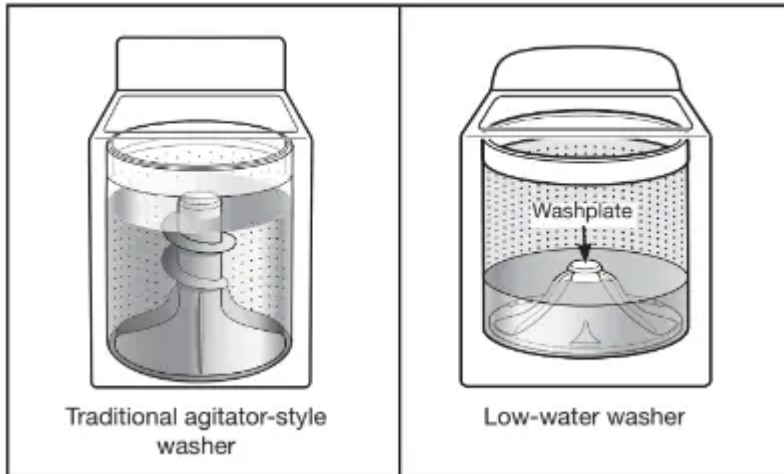

The most striking difference in your new washer is the low-water washplate wash system. The washer automatically adjusts the water level to the load size—no water level selector is needed.

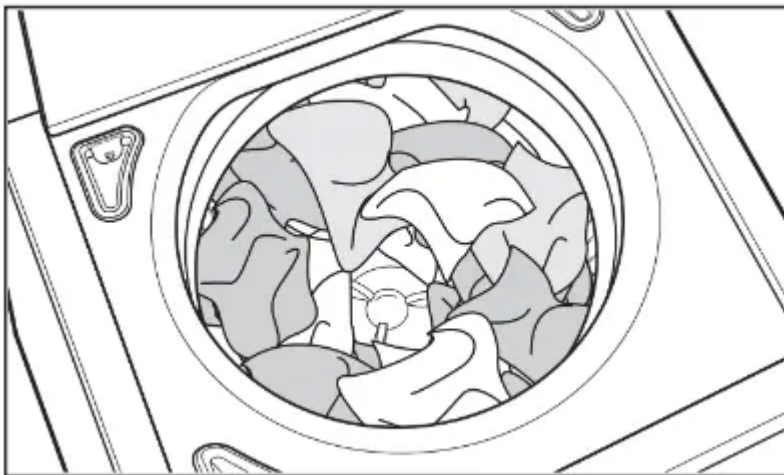

Load garments in loose heaps evenly around the washplate.

Do not load garments directly over the center of the washplate; when loaded, the center of the washplate should be visible.

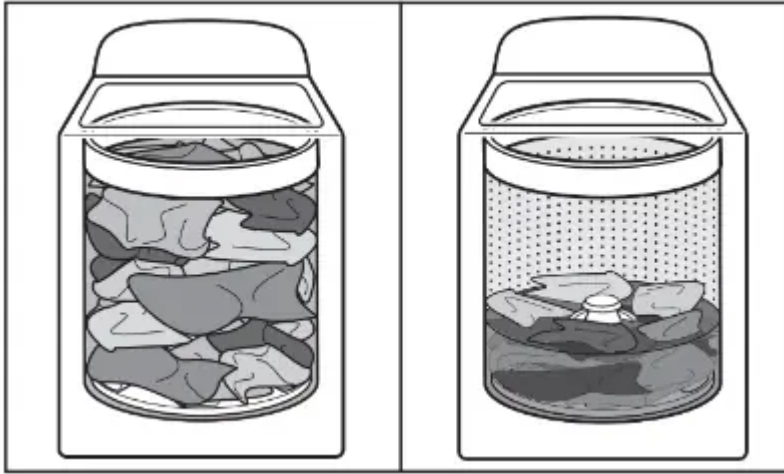

As the washer dampens and moves the load, the level of the garments will settle in the basket. This is normal, and does not indicate that more garments should be added.

IMPORTANT: You will not see a washer basket full of water as with your past agitator-style washer. It is normal for some of the load to be above the water line.

INTELLIFILL™ Water Level Control

Once you start the cycle, the lid will lock, and the washer will begin the sensing process to determine the correct water level for the load. You will find a step-by-step description in the “Cycle Status Lights” section.

You will hear the motor turn the basket in short pulses to thoroughly wet the load. This low-water wash method uses less water and energy compared to a traditional agitator-style washer.

Auto Temperature Control

Auto Temperature Control (ATC) regulates incoming hot and cold water, blending the temperatures for optimal and consistent cleaning. The ATC is automatically turned on when a cycle is selected.

Choosing the Right Detergent

Use only High Efficiency detergents. The package will be marked “HE” or “High Efficiency.” Low-water washing creates excessive sudsing with a regular non-HE detergent. Using regular detergent will likely result in longer cycle times and reduced rinsing performance. It may also result in component failures and noticeable mold or mildew. HE detergents are made to produce the right amount of suds for the best performance. Follow the manufacturer’s instructions to determine the amount of detergent to use.



Use only High Efficiency (HE) detergent.

Concentrated Cleaning

Low-water cleaning means concentrated cleaning. Rather than diluting detergent as done in an agitator-style washer, this washer delivers the detergent directly to the soils.

Normal Sounds You Can Expect

At different stages of the wash cycle, you may hear sounds and noises that are different from those of your previous washer. For example, you may hear a clicking and hum at the beginning of the cycle, as the lid lock goes through a self-test. There will be different kinds of humming and whirring sounds as the washplate moves the load. And sometimes, you may hear nothing at all, as the washer determines the correct water level for your load or allows time for garments to soak.

CONTROL PANEL AND FEATURES

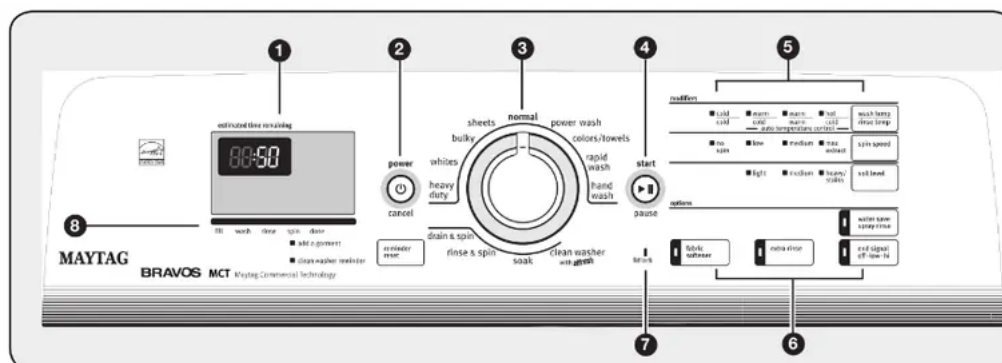

Not all features and cycles are available on all models.

1. ESTIMATED TIME REMAINING DISPLAY

The Estimated Time Remaining display shows the time required for the cycle to complete. Factors such as load size and water pressure may affect the time shown in the display. Tightly packed, unbalanced loads, or excessive suds may cause the washer to adjust the cycle time, as well.

2. POWER/CANCEL BUTTON

Press to turn the washer ON or OFF.

3. WASH CYCLE KNOB



Use the Wash Cycle knob to select available cycles on your washer. Turn the knob to select a cycle for your laundry load. See “Cycle Guide” for detailed descriptions of cycles.

4. START/PAUSE BUTTON

Press to start the selected cycle. Be sure all desired Modifiers and Options have been selected. Press START/ PAUSE once to unlock the lid and add a garment. Press START/ PAUSE to complete the cycle from where it was stopped. The lid must be closed for the washer to start.

5. CYCLE MODIFIERS

When you select a cycle, its default modifiers will light up. Not all cycles, options, and modifiers are available on all models.

WASH TEMP/RINSE TEMP

Select a water temperature based on the type of load you are washing. Use the warmest wash water suitable for fabrics. Follow garment label instructions.

Warm rinses leave the loads drier and more comfortable to handle than cold rinses. However, warm rinses also increase wrinkling. Cold rinses may help with wrinkling and save energy.

NOTE: In wash water temperatures colder than 60°F (15.6°C), detergents do not dissolve well. Soils may be difficult to remove.

SPIN SPEED

This washer automatically selects the spin speed based on the cycle selected. The preset speeds can be changed. Not all spin speeds are available with all cycles.

Faster spin speeds mean shorter dry times, but may increase wrinkling in your load.

Slower spin speeds mean less wrinkling, but will leave your load more damp.

SOIL LEVEL

Soil Level (wash time) is preset for each wash cycle. As you press Soil Level, the cycle time (minutes) will increase or decrease in the Estimated Time Remaining display and a different wash time will appear.

For most loads, use the Soil Level that is preset with the cycle you have chosen. For heavily soiled and sturdy fabrics, press SOIL LEVEL to select more wash time, if needed. For lightly soiled and delicate fabrics, press SOIL LEVEL to select less wash time, if needed. Lower Soil Level setting will help reduce tangling and wrinkling.

6. CYCLE OPTIONS

When you select a cycle, its default options will light up. Not all cycles, options, and modifiers are available on all models.

WATER SAVE SPRAY RINSE

Use this option to save water by using a spray rinse instead of a deep water rinse. This option is the default setting on some cycles, and selectable on other cycles. When using fabric softener, always select the Fabric Softener button, or select Extra Rinse; both of these options will dispense fabric softener in a deep rinse.

FABRIC SOFTENER

This option must be selected if using fabric softener during a cycle. It ensures that fabric softener is added at the correct time in the rinse for even distribution.

EXTRA RINSE

This option can be used to automatically add a second rinse to most cycles.

END SIGNAL

Use this option to adjust volume of the signal that sounds at end of cycle. You may select Hi, Low, or Off (no indicator lit). A louder signal is helpful in removing items as soon as cycle is complete.

You may also add or remove options for each cycle. Not all options can be used with all cycles, and some are preset to work with certain cycles.

7. LID LOCK INDICATOR

This light indicates that the lid is locked and cannot be opened. If you need to open the lid, press START/PAUSE. The lid will unlock once the washer movement has stopped. This may take several minutes if the load was spinning at high speed. Press START/PAUSE again to restart the cycle.



8. CYCLE STATUS LIGHT INDICATORS

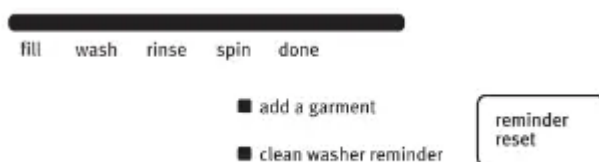

The Cycle Status Lights show the progress of a cycle. At each stage of the process, you may notice sounds or pauses that are different from traditional washers.

FILL

When the Start/Pause button is pressed, the washer will add a small amount of water to the load, then pause for a few seconds. The lid will then lock and the washer will continue to fill.

WASH

You will hear the motor and washplate moving the load. Unlike traditional washers, the load is not covered with water. Low-water cleaning means concentrated cleaning. Rather than diluting detergent as done in an agitator-style washer, this washer delivers the detergent directly to the soils. The motor sounds may change at different stages in the cycle. The wash time is determined by the selected Soil Level.

RINSE

You will hear sounds similar to the wash cycle as the washer rinses and moves the load. You may hear the motor turning on briefly (short hum) to move the basket while filling. Fabric softener will be added if the Fabric Softener option was selected. Some cycles use spray rinsing.

SPIN

The washer spins the load at increasing speeds for proper water removal, based on the selected cycle and spin speed.

DONE

Once the cycle is complete, this light will come on. Remove the load promptly for best results.

ADD A GARMENT

You may place additional clothing in the wash when the Add a Garment indicator light is glowing without sacrificing wash performance. Press START/Pause once. The Lid Lock light will turn off. Open the washer lid, add garments and close the lid. Press START/Pause to restart.

CLEAN WASHER REMINDER

The Clean Washer Reminder indicator lights after 30 wash cycles without a clean washer cycle. See the "Cleaning Your Washer" section to run the clean washer cycle, or you can press REMINDER RESET button to manually reset clean washer cycle counter.

DISPENSERS

A. High Efficiency "HE" detergent dispenser

Add liquid or powdered HE detergent to this dispenser for your main wash cycle.



Use only High Efficiency (HE) detergent.

B. Liquid chlorine bleach dispenser

This dispenser holds up to 3/4 cup (180 mL) liquid chlorine bleach. The bleach will be automatically diluted and dispensed at the optimum time during the the wash cycle. This dispenser cannot dilute powdered bleach.

NOTE: Fill dispenser only with liquid chlorine bleach.

C. Liquid fabric softener dispenser

Pour measured liquid fabric softener into the liquid fabric softener dispenser, if desired. It will dispense automatically at the optimum time when the Fabric Softener option is selected.

- Use only liquid fabric softener in this dispenser.

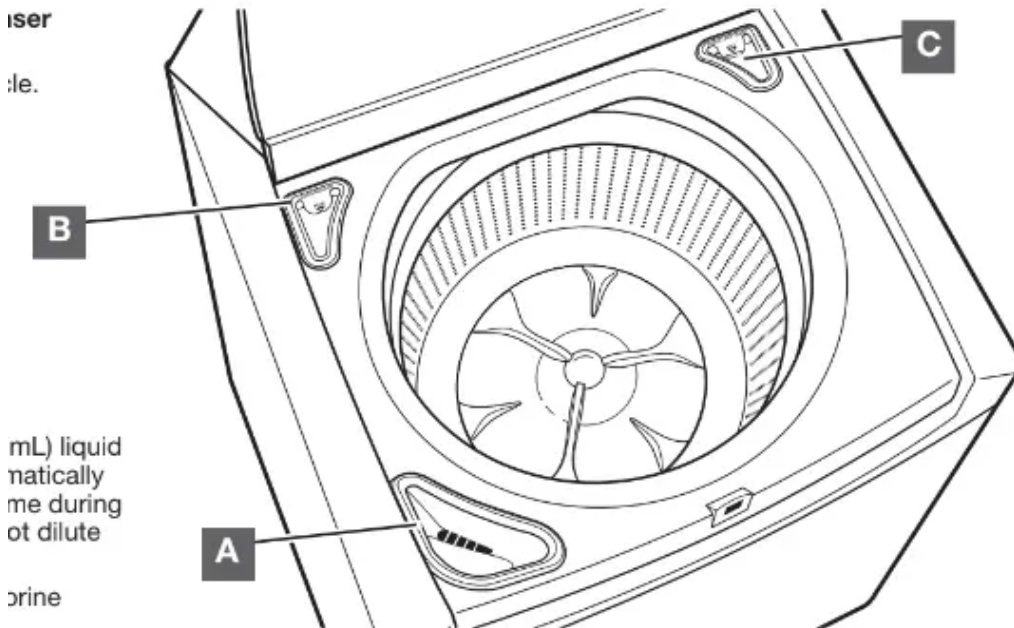

iser

le.

mL) liquid
natically
me during
ot dilute

orine

o the

USING YOUR WASHER

⚠ WARNING



Fire Hazard

Never place items in the washer that are dampened with gasoline or other flammable fluids.

No washer can completely remove oil.

Do not dry anything that has ever had any type of oil on it (including cooking oils).

Doing so can result in death, explosion, or fire.

1. Sort and prepare your laundry

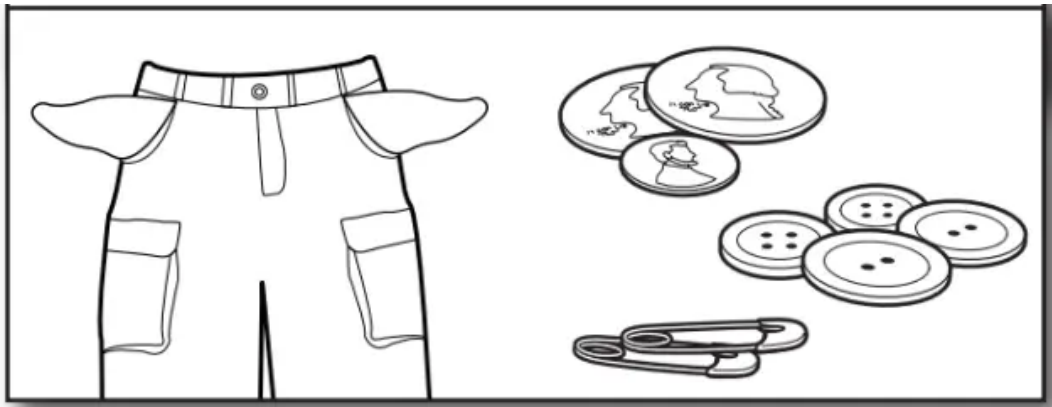

- Empty pockets. Loose change, buttons, or any small object can pass under the washplate and become trapped, causing unexpected sounds.
- Sort items by recommended cycle, water temperature, and colorfastness.
- Separate heavily soiled items from lightly soiled.
- Separate delicate items from sturdy fabrics.
- Do not dry garments if stains remain after washing; heat can set stains into fabric.
- Treat stains promptly.
- Close zippers, fasten hooks, tie strings and sashes.
- Remove non-washable trim and ornaments.
- Mend rips and tears to avoid further damage to items during washing.

Helpful Tips:

- When washing water-proof or water-resistant items, load evenly. See “Cycle Guide” for tips and more information on using the Bulky cycle.
- Use mesh bags to help avoid tangling when washing delicate or small items.
- Turn knits inside out to avoid pilling. Separate lint-takers from lint-givers. Synthetics, knits, and corduroy fabrics will pick up lint from towels, rugs, and chenille fabrics.

NOTE: Always read and follow fabric care labels instructions to avoid damage to your garments.

⚠ WARNING

Electrical Shock Hazard
Plug into a grounded 3 prong outlet.
Do not remove ground prong.
Do not use an adapter.
Do not use an extension cord.
Failure to follow these instructions can result in death, fire, or electrical shock.

2. Load laundry into washer



Load garments in loose heaps evenly around the washplate. Do not load garments directly over the center of the washplate; when loaded, the center of the washplate should be visible. Try mixing different sized garments to reduce tangling.

IMPORTANT: Garments need to move freely for best cleaning and to reduce wrinkling and tangling.

Using Laundry Product Dispensers

3. Add HE detergent to dispenser

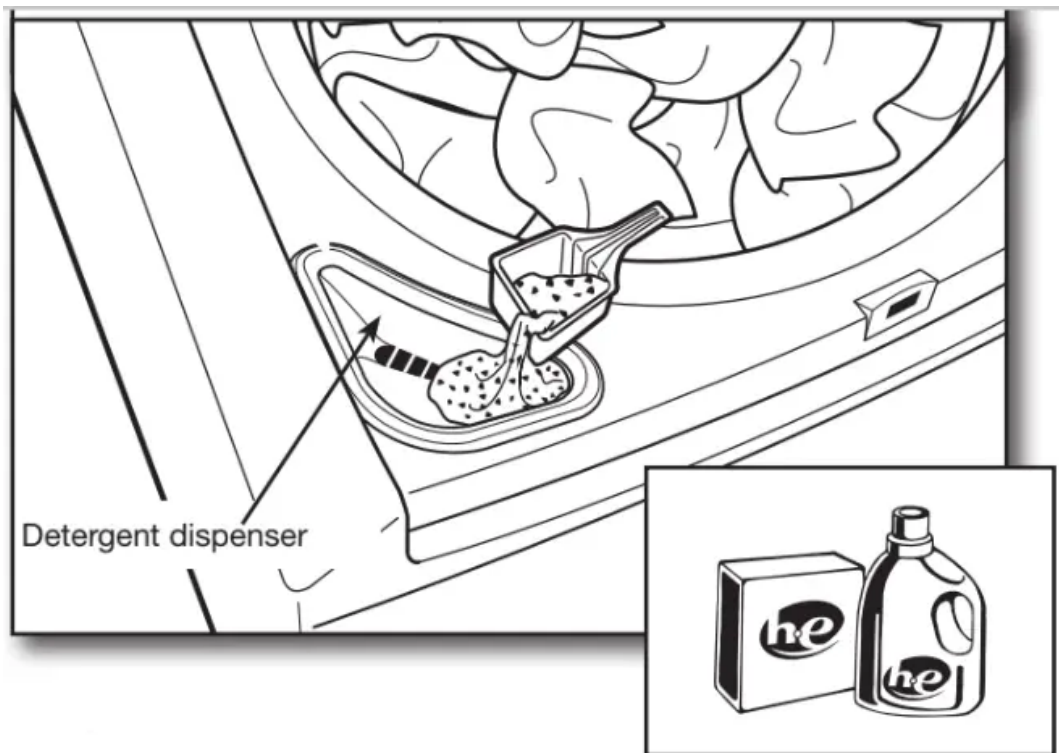

Add a measured amount of HE detergent into detergent dispenser.

IMPORTANT: Use only High Efficiency detergents. The package will be marked “HE” or “High Efficiency.” Low-water washing creates excessive sudsing with a regular non-HE detergent. Using regular detergent will likely result in longer cycle times and reduced rinsing performance. It may also result in component failures and noticeable mold or mildew. HE detergents are made to produce the right amount of suds for the best performance.

Follow the manufacturer’s instructions to determine the amount of detergent to use.

NOTE: If using an Oxi laundry boost product, add to the detergent dispenser.

HELPFUL TIP: See “Washer Maintenance” for information on recommended method of cleaning washer dispensers.

4. Add liquid chlorine bleach to dispenser

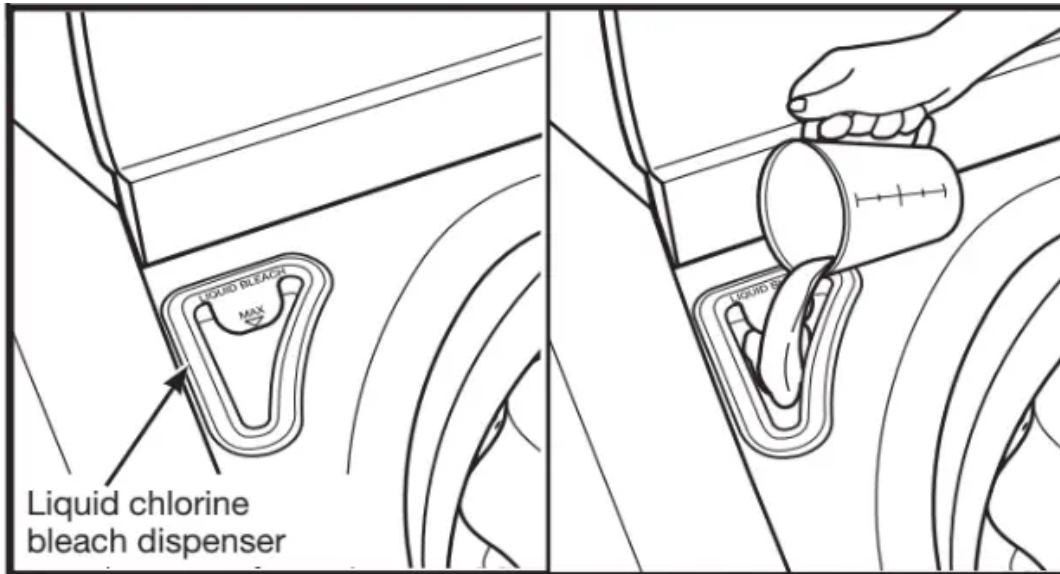

Do not overfill, dilute, or use more than 3/4 cup (180 mL).

Do not use color-safe bleach or Oxi products in the same cycle with liquid chlorine bleach.

5. Add fabric softener to dispenser

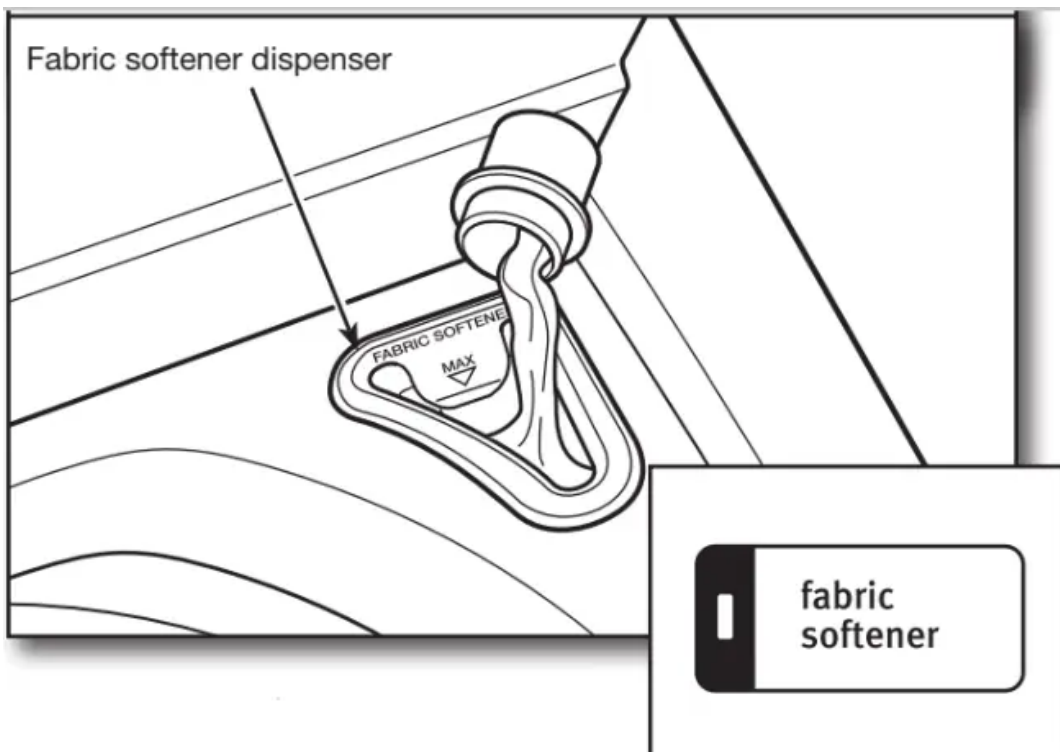

Pour a measured amount of liquid fabric softener into dispenser; always follow manufacturer's directions for correct amount of fabric softener based on your load size. Then select Fabric Softener option.

IMPORTANT: Fabric Softener option must be selected to ensure proper distribution at correct time in cycle. Do not overfill or dilute. Overfilling dispenser will cause fabric softener to immediately dispense into washer.

If Extra Rinse option is selected, fabric softener will be dispensed in the last rinse.

NOTE: Do not use liquid fabric softener dispenser balls in this washer. They will not dispense correctly.

Starting Your Washer

6. Press POWER/CANCEL to turn on washer

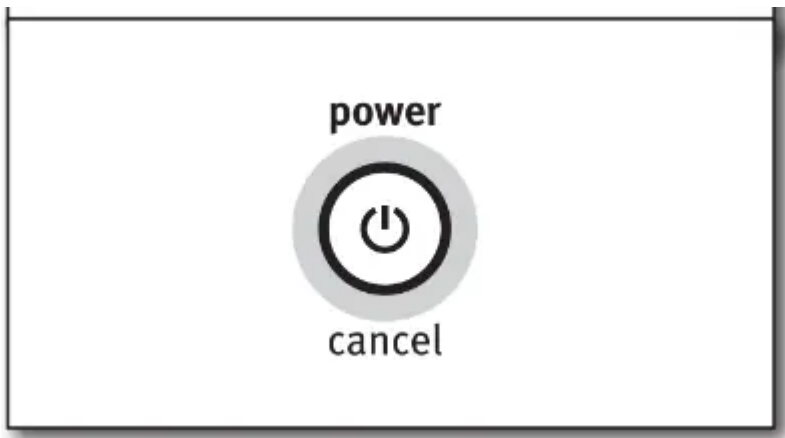

Make sure the dispenser drawer is closed completely, then press POWER/CANCEL to turn on the washer.

7. Select cycle

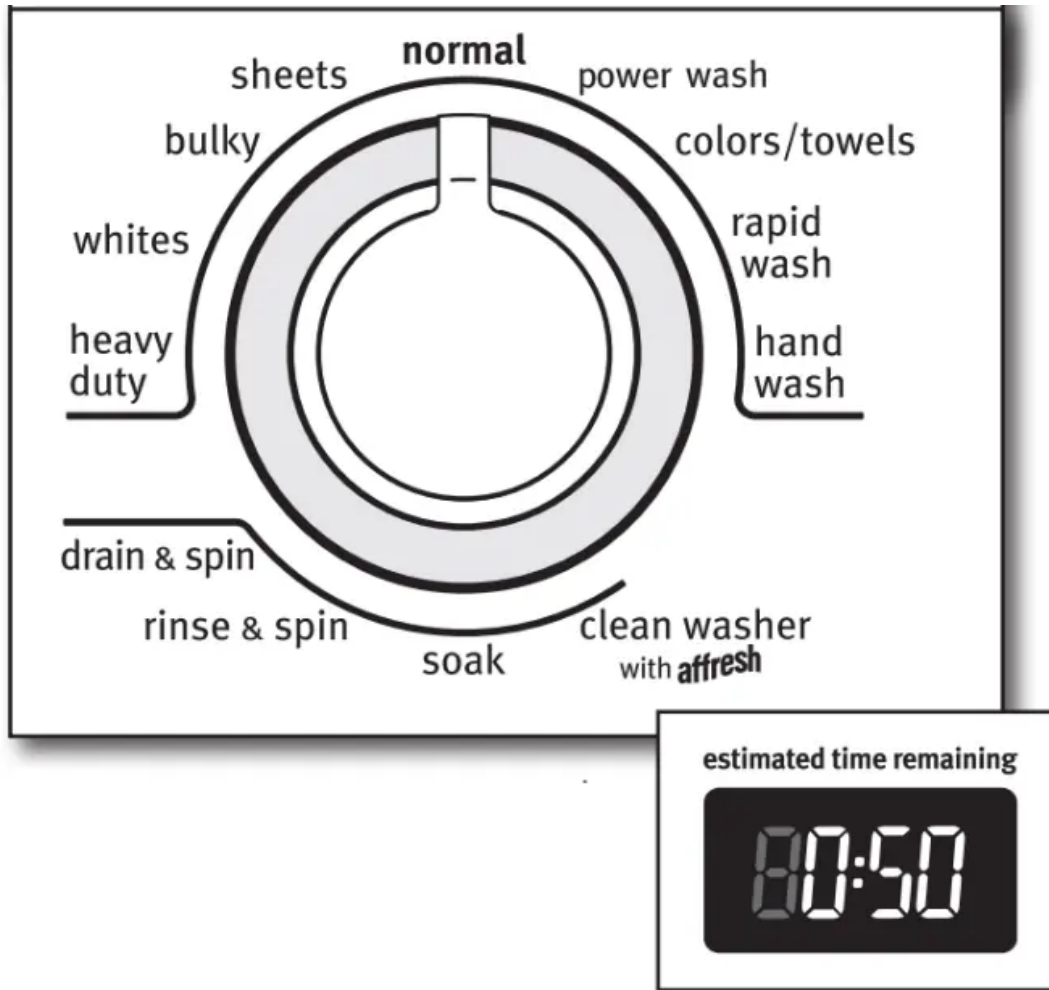

Turn cycle knob to choose your wash cycle. The indicator for Estimated Time Remaining will light up with a cycle time. For more information, see “Control Panel”.

8. Select cycle modifiers

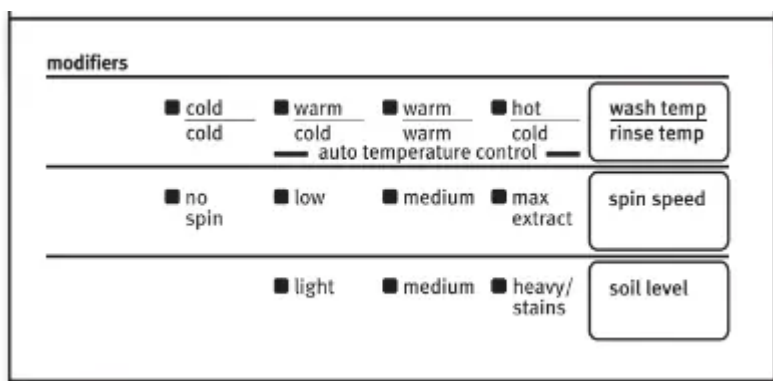

Once you select a cycle, the default settings for that cycle will be lit. Press the Modifier buttons to change the Soil Level, Spin Speed, and Wash/Rinse Temperature, if desired. Not all settings are available with all cycles.

NOTE: Always read and follow fabric care labels instructions to avoid damage to your garments.

Wash Temp	Suggested Fabrics
Hot Some cold water is added to save energy. This will be cooler than your hot water heater setting.	Whites and pastels Durable garments Heavy soils
Warm Some cold water will be added, so this may be cooler than what your previous washer provided.	Bright colors Moderate to light soils
Cold Warm water may be added to assist in soil removal and to help dissolve detergents.	Dark colors that bleed or fade Light soils

9. Select cycle options

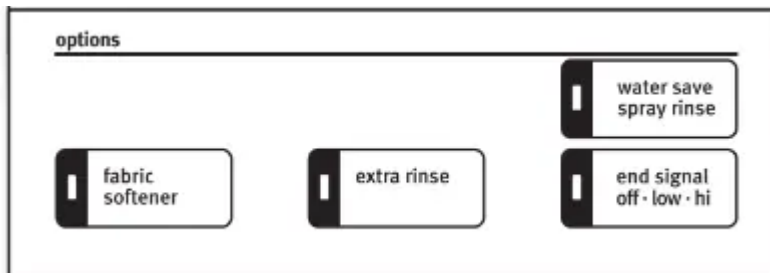

Select any other cycle options you may wish to add, if not previously set. Some cycles will automatically add certain options such as Extra Rinse. These may be turned off, if desired.

NOTE: Not all options are available with all cycles.

10. Press START/PAUSE to begin wash cycle



Press the START/PAUSE button to start the wash cycle. When the cycle has finished, the DONE indicator will light and the end of cycle signal will sound (if set). Promptly remove

garments when cycle is done to prevent odor, reduce wrinkling, and rusting of metal hooks, zippers, and snaps.

If lid is left open for more than 10 minutes the water will pump out.

WASHER MAINTENANCE

WATER INLET HOSES

Replace inlet hoses after 5 years of use to reduce the risk of hose failure. Periodically inspect and replace inlet hoses if bulges, kinks, cuts, wear, or leaks are found.

When replacing your inlet hoses, mark the date of replacement on the label with a permanent marker.

CLEANING YOUR WASHER

Keep your washer as clean and fresh as your clothes.

To keep washer interior odor-free, follow this recommended monthly cleaning procedure:

1. Make sure the washer is empty.
2. Using recommended AFFRESH® washer cleaner, add one tablet to washer drum.

OR

If using liquid chlorine bleach, add 1 cup (250 mL) to liquid chlorine bleach dispenser.

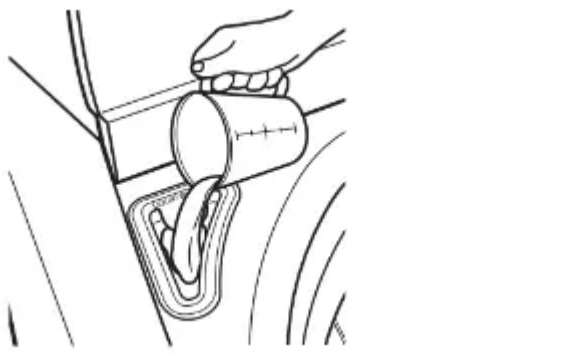

IMPORTANT: Do not add detergent to CLEAN WASHER with AFFRESHTM cycle. Do not use more than recommended amount of bleach to avoid damaging product over time.

3. Close washer lid.
4. Press POWER/CANCEL.
5. Select CLEAN WASHER with AFFRESHTM cycle.
6. Press START/PAUSE. Water will pour into washer for a moment and pause, lid will lock, then cycle will continue.

NOTE: For best results, do not interrupt cycle. If cycle must be interrupted, press START/PAUSE twice and run a RINSE AND SPIN cycle to ensure cleaner or bleach have been rinsed from washer.

To clean exterior:

1. Use a soft, damp cloth or sponge to wipe up any spills.
2. Use all-purpose surface cleaner, if needed.

IMPORTANT: To avoid damaging the washer's finish, do not use abrasive products.

CLEANING YOUR DISPENSERS

You may find laundry product residue leftover in your dispensers. To remove residue, wipe with a damp cloth and towel dry.

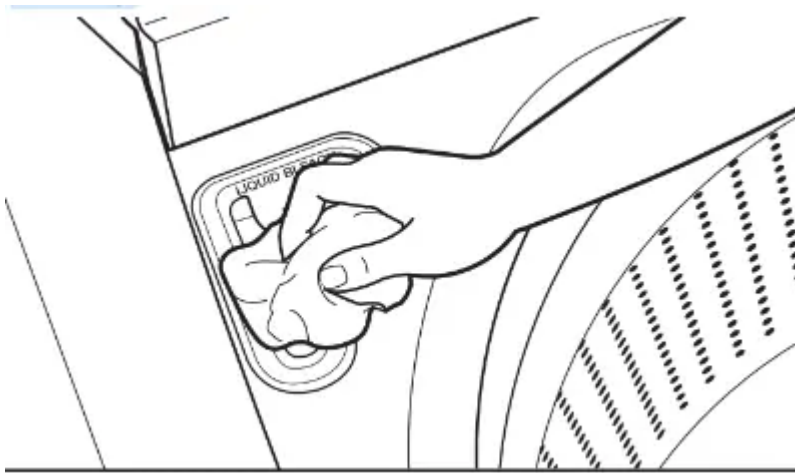

NON-USE AND VACATION CARE

Operate your washer only when you are home. If moving, or not using your washer for a period of time, follow these steps:

1. Unplug or disconnect power to washer.
2. Turn off water supply to washer, to avoid flooding due to water pressure surge.

WINTER STORAGE CARE

IMPORTANT: To avoid damage, install and store washer where it will not freeze. Because some water may stay in hoses, freezing can damage washer. If storing or moving during freezing weather, winterize your washer.

To winterize washer:

1. Shut off both water faucets; disconnect and drain water inlet hoses.
2. Put 1 qt. (1 L) of R.V.-type antifreeze in basket and run washer on RINSE & SPIN cycle for about 30 seconds to mix antifreeze and remaining water.

3. Unplug washer or disconnect power.

TRANSPORTING YOUR WASHER

1. Shut off both water faucets. Disconnect and drain water inlet hoses.
2. If washer will be moved during freezing weather, follow WINTER STORAGE CARE directions before moving.
3. Disconnect drain hose from drain system and drain any remaining water into a pan or bucket. Disconnect drain hose from back of washer.
4. Unplug power cord.
5. Place inlet hoses and drain hose inside washer basket.
6. Drape power cord over edge and into washer basket.
7. Place packing tray from original shipping materials back inside washer. If you do not have packing tray, place heavy blankets or towels into basket opening. Close lid and place tape over lid and down front of washer. Keep lid taped until washer is placed in new location. Transport washer in upright position.

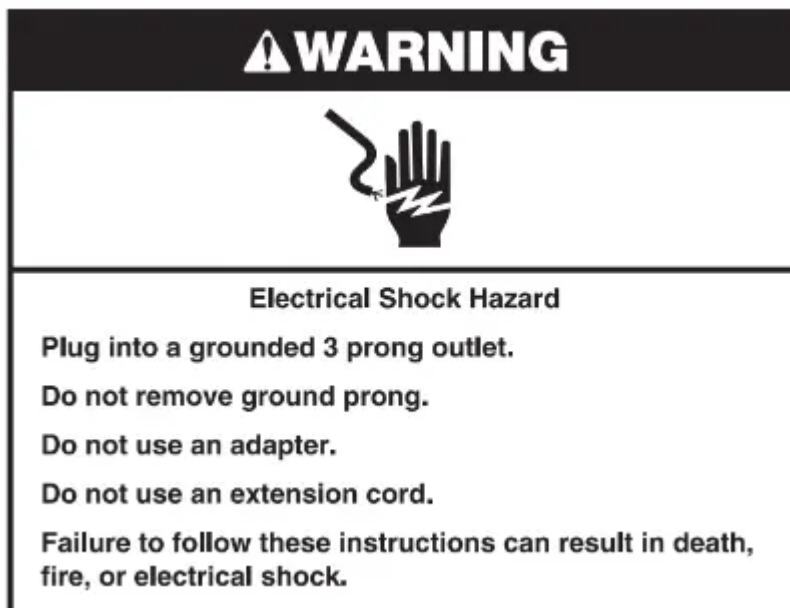

REINSTALLING/USING WASHER AGAIN

To reinstall washer after non-use, vacation, winter storage, or moving:

1. Refer to "Installation Instructions" to locate, level, and connect washer.
2. Before using again, run washer through the following recommended procedure:

To use washer again:

1. Flush water pipes and hoses. Reconnect water inlet hoses. Turn on both water faucets.
2. Plug in washer or reconnect power.

3. Run washer through BEDDING cycle to clean washer and remove antifreeze, if used. Use only HE High Efficiency detergent. Use 1/2 the manufacturer's recommended amount for a medium-size load.

TROUBLESHOOTING

Vibration or Off-Balance

If you experience	Possible Causes	Solution
Vibration, rocking, or "walking"	Feet may not be in contact with the floor and locked.	Front and rear feet must be in firm contact with floor, and washer must be level to operate properly. Jam nuts must be tight against the bottom of the cabinet.
	Washer may not be level.	Check floor for flexing or sagging. If flooring is uneven, a 3/4" (19 mm) piece of plywood under your washer will reduce sound.
Vibration during spinning or washer stopped with all dial lights flashing	Load could be unbalanced.	Load garments in loose heaps evenly around the washplate. Do not load garments directly over the center of the washplate. Adding wet items to washer or adding more water to basket could unbalance washer.
		Avoid washing single items. Balance a single item such as a rug or jeans jacket with a few extra items. If the dial is flashing, redistribute the load, close the lid, and press START/PAUSE.
		Use Bulky Items cycle for oversized, non-absorbent items such as comforters or poly-filled jackets. Other items are not appropriate for Bulky Items cycle. See "Cycle Guide".
		Item or load not suitable for selected cycle. See "Cycle Guide" and "Using Your Washer" in this "Use and Care Guide".

Noises – For normal operating sounds

Clicking or metallic noises	Objects caught in washer drain system.	Empty pockets before washing. Loose items such as coins could fall between basket and tub or may block pump. It may be necessary to call for service to remove items.
		It is normal to hear metal items on clothing such as metal snaps, buckles, or zippers touch against the stainless steel basket.
Gurgling or humming	Washer may be draining water.	It is normal to hear the pump making a continuous humming sound with periodic gurgling or surging as final amounts of water are removed during the spin/drain cycles.
Humming	The washer is sensing the load size.	You may hear the hum of the sensing spins after you have started the washer. This is normal. Sensing spins will take several minutes before water is added to the washer.

Water Leaks

Check the following for proper installation:	Washer not level.	Water may splash off basket if washer is not level.
	Fill hoses not attached tightly.	Tighten fill-hose connection.
	Fill hose washers	Make sure all four fill hose flat washers are properly seated.
	Drain hose connection	Pull drain hose from washer cabinet and properly secure it to drainpipe or laundry tub.
		Do not place tape over drain opening
	Check household plumbing for leaks or clogged sink or drain.	Water can backup out of a clogged sink or drainpipe. Check all household plumbing for leaks (laundry tubs, drain pipe, water pipes, and faucets.).
Washer not loaded as recommended.	An unbalanced load can cause basket to be out of alignment and cause water to splash off tub. See "Using Your Washer" for loading instructions.	

Washer not performing as expected

<p>Not enough water in washer</p>	<p>Load not completely covered in water.</p>	<p>This is normal operation for an HE low-water washer. The load will not be completely underwater. The washer senses load sizes and adds correct amount of water for optimal cleaning. See “What’s New under the Lid.” IMPORTANT: Do not add more water to washer. The added water lifts the load off the washplate, resulting in less cleaning.</p>
<p>Washer won’t run or fill, washer stops working</p>	<p>Check for proper water supply.</p>	<p>Both hoses must be attached and have water flowing to inlet valve.</p> <p>Both Hot and Cold water faucets must be turned on.</p> <p>Check that inlet valve screens have not become clogged.</p> <p>Check for any kinks in inlet hoses, which can restrict water flow.</p>

⚠ WARNING



Electrical Shock Hazard

Plug into a grounded 3 prong outlet.

Do not remove ground prong.

Do not use an adapter.

Do not use an extension cord.

Failure to follow these instructions can result in death, fire, or electrical shock.

Washer won't run or fill, washer stops working (cont.)	Check proper electrical supply.	Plug power cord into a grounded 3 prong outlet.
		Do not use an extension cord.
		Ensure there is power to outlet.
		Reset a tripped circuit breaker. Replace any blown fuses. NOTE: If problems continue, contact an electrician.
	Normal washer operation.	Lid must be closed for washer to run.
		Washer will pause during certain phases of cycle. Do not interrupt cycle.
		Washer may be stopped to reduce suds.
		The washer senses the dry load with short spins that may take 2 to 3 minutes before water is added. You may hear the hum of the spins. This is normal.
	Washer may be tightly packed.	Remove several items, rearrange load evenly around the washplate. Do not load garments directly over the center of the washplate. Close lid and press Start/Pause.
		Add only 1 or 2 additional garments after the washer has started.
Do not add more water to the washer.		
Not using HE detergent or using too much HE detergent.	Only use HE detergent. Suds from regular detergents can slow or stop the washer. Always measure detergent and following detergent directions based on your load requirements.	
	To remove suds, cancel cycle. Select DRAIN & SPIN. Select your cycle. Press START/PAUSE. Do not add more detergent.	
Washer not draining/	Empty pockets and use garment bags for small items.	Small items may have been caught in pump or between basket and tub, which can slow draining.



spinning, loads are still wet	Using cycles with a lower spin speed.	Cycles with lower spin speeds remove less water than cycles with high spin speeds. Use the recommended cycle/speed spin for your garment.
	Washer may be tightly packed or unbalanced.	Tightly packed loads may not allow the washer to spin correctly, leaving the load wetter than normal. Evenly arrange the wet load for balanced spinning. Select DRAIN & SPIN to remove excess water. See "Using Your Washer" for loading recommendations.
	Check plumbing for correct drain hose installation. Drain hose extends into standpipe farther than 4.5" (114 mm).	Check drain hose for proper installation. Use drain hose form and securely attach to drainpipe or tub. Do not tape over drain opening. Lower drain hose if the end is higher than 96" (2.4 m) above the floor. Remove any clogs from drain hose.
	Not using HE detergent or using too much HE detergent.	Suds from regular detergent or using too much detergent can slow or stop draining or spinning. Use only HE detergent. Always measure and follow detergent directions for your load. To remove extra suds, Select RINSE & SPIN. Do not add detergent.
Incorrect or wrong wash or rinse temperatures	Check for proper water supply.	Make sure hot and cold inlet hoses are not reversed.
		Both hoses must be attached to both washer and faucet, and have both hot and cold water flowing to inlet valve.
		Check that inlet valve screens are not clogged.
	Remove any kinks in hoses.	
	Energy-saving controlled wash temperatures.	Energy Star® qualified washers use cooler wash and rinse water temperatures than traditional top-load washers. This includes cooler hot and warm washes.
Load not rinsed	Check for proper water supply.	Make sure hot and cold inlet hoses are not reversed.



		Both hoses must be attached and have water flowing to the inlet valve.
		Both hot and cold water faucets must be on.
		Inlet valve screens on washer maybe clogged.
		Remove any kinks in the inlet hose.
	Not using HE detergent or using too much HE detergent.	The suds from regular detergent can cause the washer to operate incorrectly.
		Use only HE detergent. Be sure to measure correctly.
		Always measure detergent and follow detergent directions based on load size and soil level.
	Washer may be tightly packed.	The washer is less efficient at rinsing when load is tightly packed.
		Load garments in loose heaps evenly around the washplate. Do not load garments directly over the center of the washplate.
		Use cycle designed for the fabrics being washed.
		Add only 1 or 2 additional garments after washer has started.
	Fabric softener option not selected.	When using fabric softener, be sure the Fabric Softener option is selected.
Sand, pet hair, lint, etc. on load after washing	Heavy sand, pet hair, lint, and detergent or bleach residues may require additional rinsing.	Add an Extra Rinse to the selected cycle.
Load is tangling	Washer not loaded as recommended.	Load garments in loose heaps evenly around the washplate. Do not load garments directly over the center of the washplate.



		<p>Reduce tangling by mixing types of load items.</p> <p>Use the recommended cycle for the type of garments being washed.</p>
	<p>Wash action and/or spin speed too fast for load.</p>	<p>Select a cycle with a slower wash action and slower spin speed.</p> <p>Note that items will be wetter than when using a higher speed spin.</p>
<p>Not cleaning or removing stains</p>	<p>Wash load not completely covered in water.</p>	<p>Washer senses load size and adds correct amount of water.</p> <p>This is normal and necessary for clothes to move.</p>
	<p>Added more water to washer.</p>	<p>Do not add more water to washer. Adding water lifts the garments off the washplate, resulting in less effective cleaning.</p>
	<p>Washer not loaded as recommended.</p>	<p>Load garments in loose heaps evenly around the washplate.</p> <p>Do not load garments directly over the center of the washplate.</p>
		<p>Add only 1 or 2 additional garments after washer has started.</p>
	<p>Not using HE detergent or using too much HE detergent.</p>	<p>The suds from regular detergent can prevent washer from operating correctly.</p>
		<p>Use only HE detergent. Be sure to measure correctly.</p>
		<p>Always measure detergent and follow detergent directions based on load size and soil level.</p>
<p>Not using correct cycle for fabric type.</p>	<p>Use a higher soil level cycle option and warmer wash temperature to improve cleaning.</p>	
	<p>If using Rapid Wash cycle (on some models), wash only a few items.</p>	
	<p>Use Whites and Heavy Duty cycle for tough cleaning.</p>	



		See the “Cycle Guide” to match your load with the best cycle.
	Not using dispensers.	Use dispensers to avoid chlorine bleach and fabric softener staining.
		Load dispensers before starting a cycle.
		Avoid overfilling.
		Do not add products directly onto load.
	Not washing like colors together.	Wash like colors together and remove promptly after the cycle is complete to avoid dye transfer.
Odors	Monthly maintenance not done as recommended.	Run the Clean Washer with AFFRESHTM cycle after every 30 washes. See “Cleaning Your Washer” in “Washer Maintenance”.
		Unload washer as soon as cycle is complete.
	Not using HE detergent or using too much HE detergent.	Use only HE detergent. Be sure to measure correctly.
		Always follow the detergent directions.
		See “Cleaning your Washer” section.
Fabric Damage	Sharp items were in pockets during wash cycle.	Empty pockets, zip zippers, and snap or hook fasteners before washing to avoid snags and tears.
	Strings and straps could have tangled.	Tie all strings and straps before starting wash load.
	Items may have been damaged before washing.	Mend rips and broken threads in seams before washing.
	Fabric damage can occur if the washer is tightly packed.	Load garments in loose heaps evenly around the washplate. Do not load garments directly over the center of the washplate.
		Use cycle designed for the fabrics being washed.

		Add only 1 or 2 additional garments after washer is started.
	Garment care instructions may not have been followed.	Always read and follow garment manufacturer's care label instructions. See the "Cycle Guide" to match your load with the best cycle.
	Liquid chlorine bleach may have been added incorrectly.	Do not pour liquid chlorine bleach directly onto load. Wipe up bleach spills.
		Undiluted bleach will damage fabrics. Do not use more than recommended by manufacturer.
		Do not place load items on top of bleach dispenser when loading and unloading washer.
Incorrect dispenser operation	Clogged dispensers or laundry products dispensing too soon.	Do not overfill dispenser. Overfilling causes immediate dispensing.
		Always select Fabric Softener option to assure proper dispensing.
		Load dispensers before starting a cycle.
		It is normal for small amounts of water to be remain in dispenser at the end of the cycle.
		Homes with low water pressure may result in residual powder in the dispenser. To avoid, select a warmer wash temperature if possible, depending on your load.
	Liquid chlorine bleach not used in dispenser.	Use only liquid chlorine bleach in the Bleach dispenser.



Error Code Appears in Display

oL (overloaded) appears in display	Load too large.	If an overload is detected, the washer will drain any water and detergent in the washer. Remove several items and add HE detergent. Close lid and press START/PAUSE.
uL (unbalanced load) appears in display	Load not balanced. The washer is running a load balance correction routine.	Allow the machine to continue. If the dial is flashing and the machine has stopped, redistribute the load, close the lid, and press START/PAUSE.
LF (too long to fill) appears in display	Washer taking too long to fill. Drain extends more than 4.5" (114 mm) into standpipe.	Check plumbing for correct drain hose installation. Use drain hose form and attach securely to drainpipe or tub. Do not tape over drain opening. See "Installation Instructions".
Ld (too long to drain water) appears in display	Washer taking too long to drain water. Drain extends more than 4.5" (114 mm) into standpipe.	Check plumbing for correct drain hose installation. Use drain hose form and attach securely to drainpipe or tub. Do not tape over drain opening.
		Lower drain hose if the end is higher than 96" (2.4 m) above the floor. Remove any clogs from drain hose. See "Installation Instructions".
HC (Hot and Cold hoses reversed) appears in display	Hot and cold inlet hoses have been installed incorrectly.	This code will appear at the end of the wash cycle to indicate that cold water hose is connected to the hot water inlet and hot water hose is connected to the cold water inlet.
Sd (Excess suds) appears in display	Excessive suds in washer. Washer is running a suds reduction routine.	Allow the washer to continue. Use only HE detergent. Always measure detergent, and base detergent quantity on load size. Follow detergent manufacturer's instructions. If the dial is flashing, reselect your desired cycle using a cold wash temperature, and press START/PAUSE. Do not add detergent.
dL (Lid cannot lock) appears in display	An item in the load may be keeping the lid from locking.	Check for items directly under the lid.
	Washer lid left open.	

lid (Lid opened) appears in display		Close the lid to clear the display. If the lid is left open for more than 10 minutes, the cycle will reset and water in the washer will drain.
dU (Lid cannot unlock) appears in display	Objects on washer lid prevent it from unlocking.	Remove objects, such as a basket of laundry, from the top of the washer.
F## code (F-type error code) appears in display	System error code.	Press START/PAUSE once to clear the code. Then press START/PAUSE again to restart washer. If code appears again, call for service.
Fd (Factory Default)	Washer sets back to factory default.	To return all options and modifiers to Factory Default, press POWER/CANCEL, select Drain & Spin cycle, and then press Extra Rinse, Fabric Softener, Extra Rinse, Fabric Softener within 5 seconds. When done correctly, the 7-segment displays show "Fd" for 3 seconds and then unit returns to Standby Mode.

Warning

This content is compiled from multiple sources and is provided for reference purposes only. It may not be complete or fully applicable to all situations. If you are unable to resolve your issue, please contact the product manufacturer or an authorized service provider for official support.