

Operating System Manual

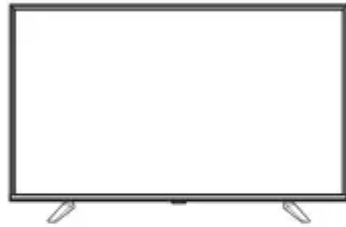

Overview

What's included:



onn POWERED BY VIZIO

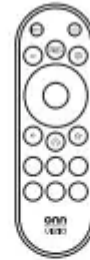

TV Remote

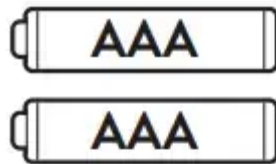

2 x AAA Batteries
for Remote

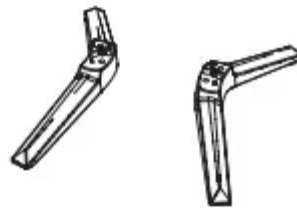

TV Stand



Screws

Tools required:

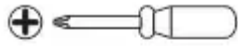

Phillips
Head
Screwdriver



Wireless
Router
(needed for
streaming)



Computer,
Tablet, or
Smartphone
(needed for setup)



Internet
Connection
(needed for
streaming)

Remote control

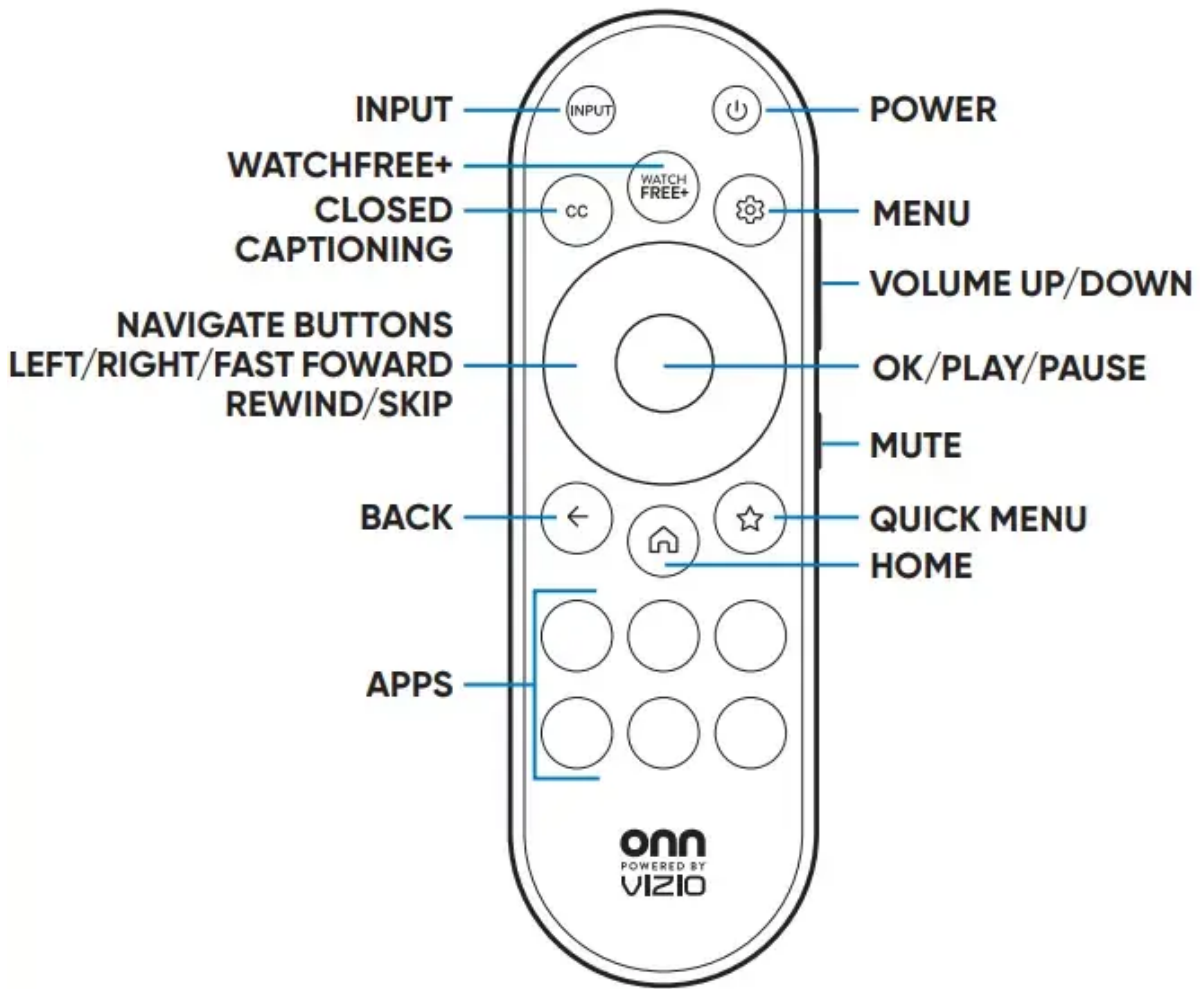

Power your TV remote by inserting the included batteries carefully matching (+) and (-) indicated inside the battery compartment.

Assembly

1. INSTALLING THE STANDS

Using a **Phillips screwdriver**

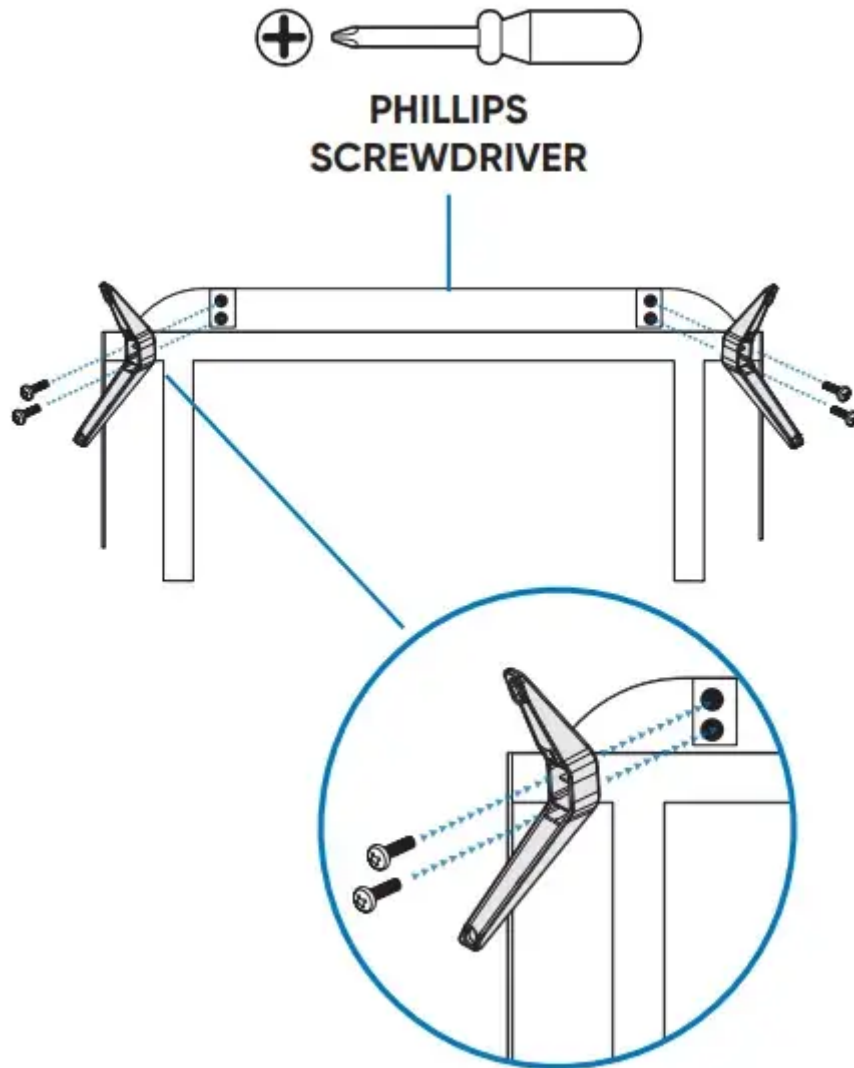

Do not install the stands if you want to wall mount your TV. See your wall mount instructions for mount installation details.

1. Place the TV screen-down on a clean, flat, soft surface (e.g.: blanket) to prevent scratches or damage to the screen.
2. Use a Phillips screwdriver to attach each stand with the provided screws. Make sure the stand screws are fully tightened and the stands do not shift or move.
3. Place the TV upright on a stable, level surface.

2. CONNECTING DEVICE

HDMI

connect a Blu-ray, DVD player, gaming console or other devices

Best Quality

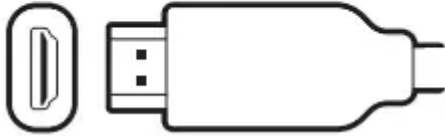

DIGITAL OPTICAL

connect an external digital audio system

Better Quality

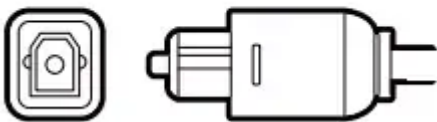

COAXIAL

connect to antenna/cable

Good Quality



USB

connect for photos, music, movies and more

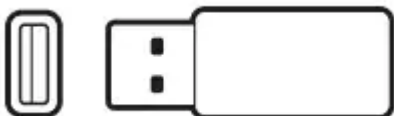

CONNECTING TO POWER

After connecting all your devices, connect the power cord to a power outlet. The TV enters standby mode and its indicator light turns red.

Initial Setup

1. Choose your language. Pressing the MUTE button will enable TTS (text-to-speech) functionality.



2. For 2K TVs, the IR remote does not require pairing. For 4K TVs, the voice remote requires pairing.

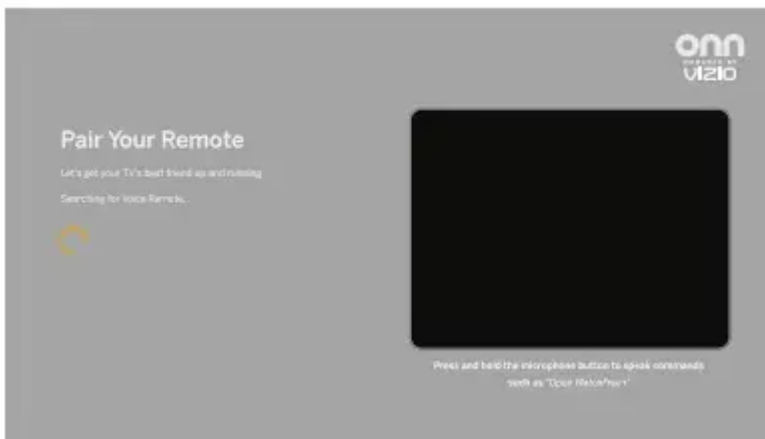

3. WiFi network and enter the password.



4. Choose your TV's location.

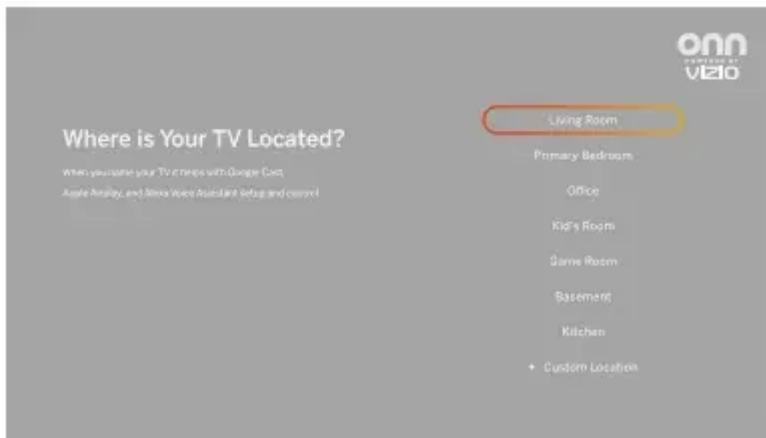

5. Accept the VIZIO Terms and Conditions.

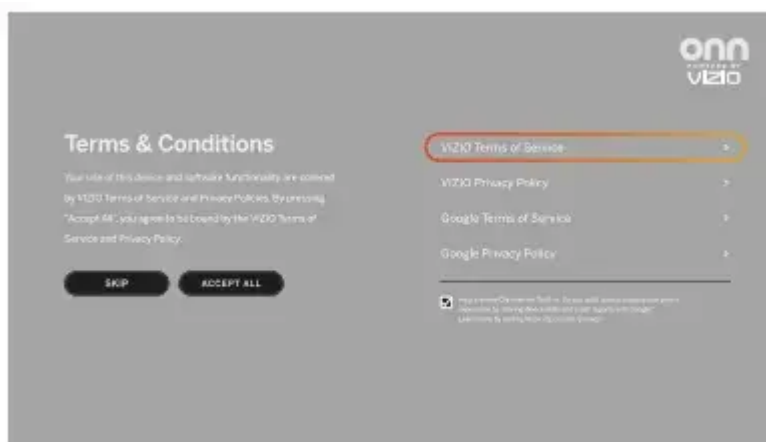

6. Scan the QR code with your smartphone to set up your customer account and connect it to your TV. Setup on web is also available.

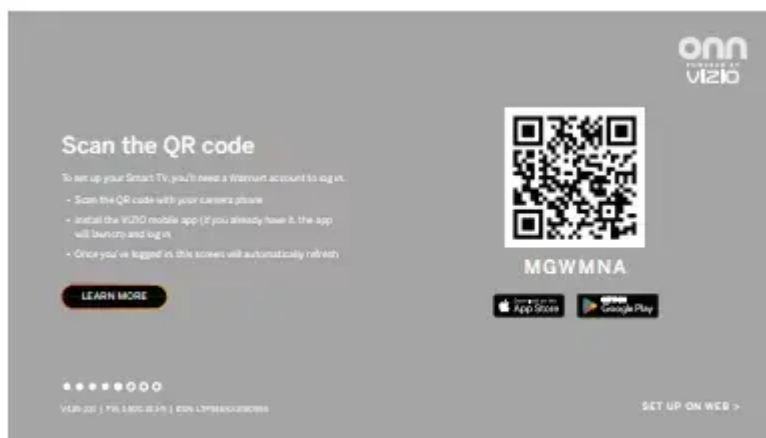

7. Accept the VIZIO Viewing Data policy.

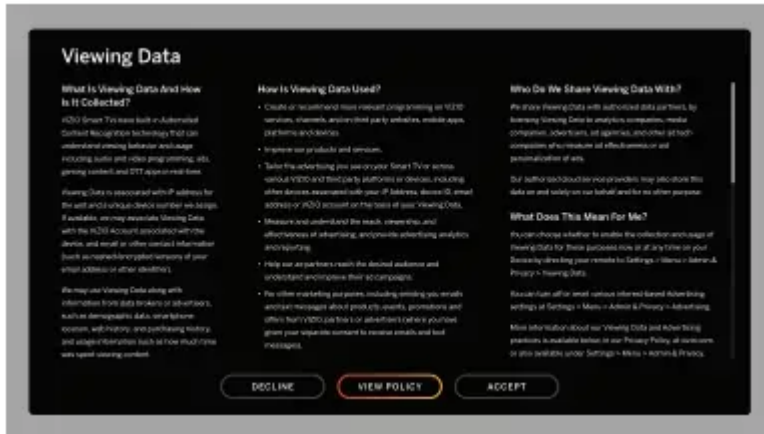

8. Accept the VIZIO Activity Data policy.

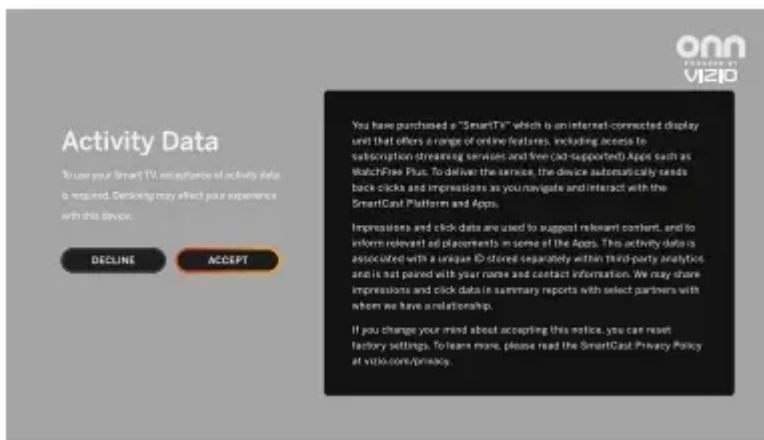

9. The setup is complete.



Pairing Bluetooth Headphones

To pair Bluetooth headphones:

1. Press the **MENU** button on the remote. The **Quick Settings** menu opens.
2. Use the **Navigation** buttons to highlight **PAIR HEADPHONES**, and press the **OK** button.

3. Set your Bluetooth headphones to pairing mode (see your device manual for instructions). The headphones will appear in the list of **Other Devices**.
4. Select your Bluetooth headphones and press the **OK** button.
5. Once paired, the device will be listed under Paired Devices and is ready for listening.

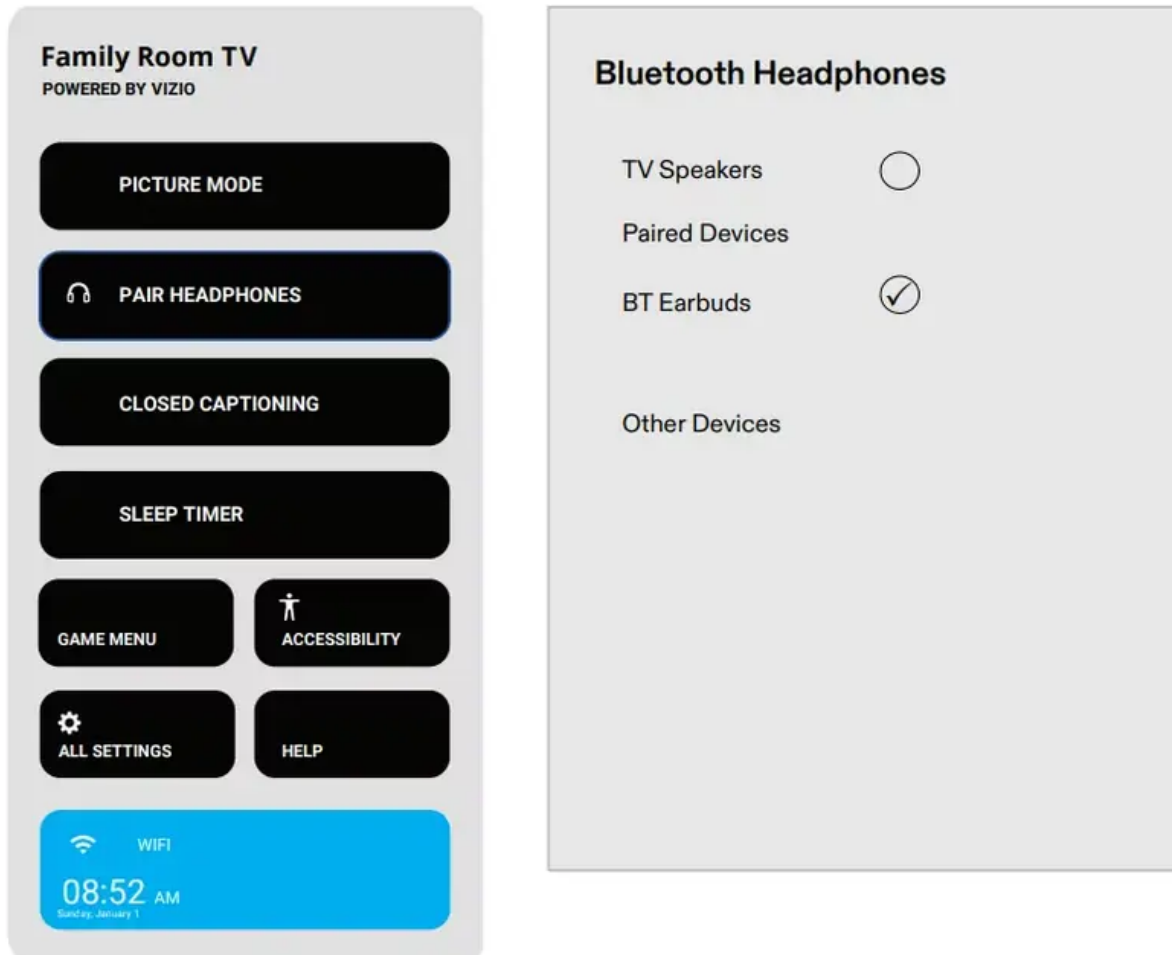

VIZIO OS Overview

What is VIZIO OS?

VIZIO OS powers your Smart TV to provide all the apps you want, free live TV and On Demand movies and shows with WatchFree+, and the VIZIO mobile app to control your experience.

VIZIO OS is entertainment made easy.

Launching the HOME SCREEN

To begin streaming from the HOME SCREEN:

Press the Home button on your remote. - or- Select HOME from the list of inputs on your remote.

What You Can Do with VIZIO OS

- Stream high-quality entertainment and find movies, shows, sports, local news, and more in one place.
- Easily access and launch the most popular streaming apps directly from your Home Screen.
- Discover and enjoy FREE live TV channels and On Demand movies and shows with VIZIO WatchFree+.
- Customize your experience with shortcuts to your favorite content, apps, and settings.
- Get built-in compatibility with connected devices from Amazon, Google, and Apple.



- Use Voice Search for faster content and feature discovery.

Plus, your TV keeps getting smarter with free and continuous platform updates.

Controlling Your TV with the VIZIO mobile app

Download the VIZIO mobile app to turn your phone into a powerful entertainment companion.

With the VIZIO mobile app, you can:

- Control your TV with your smartphone.
- Find what to watch across multiple streaming services all in one place.
- Launch apps and find content hands-free with voice control.
- Stream free live channels on WatchFree+.

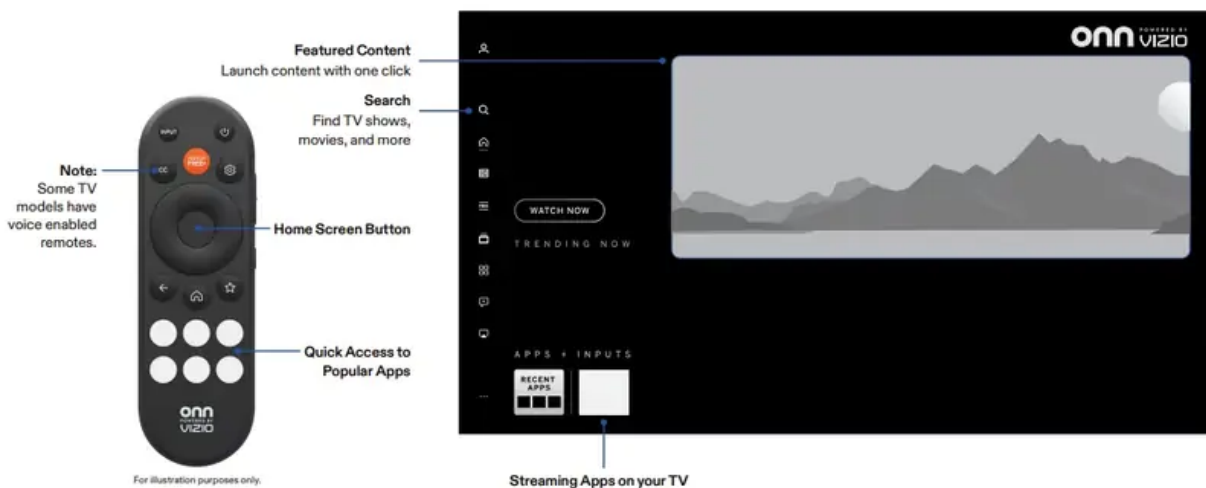

What is WatchFree+?

VIZIO WatchFree+ delivers hundreds of free, live TV channels plus tens of thousands of On Demand movies and shows, all available directly on the VIZIO OS, all free.

Easily find entertainment content including blockbuster hits and must-see shows with intuitive navigation features on VIZIO WatchFree+.

What You Can Do with WatchFree+

- Stream live TV channels for FREE – local news, movies, sports, comedy, music, and more.
- Watch On Demand movies and shows for FREE including action, comedy, horror, crime, romance, and more.
- Customize your experience by easily accessing favorite channels and personalized content.
- Find the content you love with robust search tools that filter by title, genre, or category

How to Launch WatchFree+

To launch and begin watching entertainment offered on VIZIO WatchFree+, you can:

1.



Press the WatchFree+ button on your remote; or

2. Select WatchFree+ from the list of inputs; or

3. Select the WatchFree+ app on the Apps & Inputs row on the Home Screen.

On-Screen Guide
Hundreds of live TV and audio channels organized by genre.

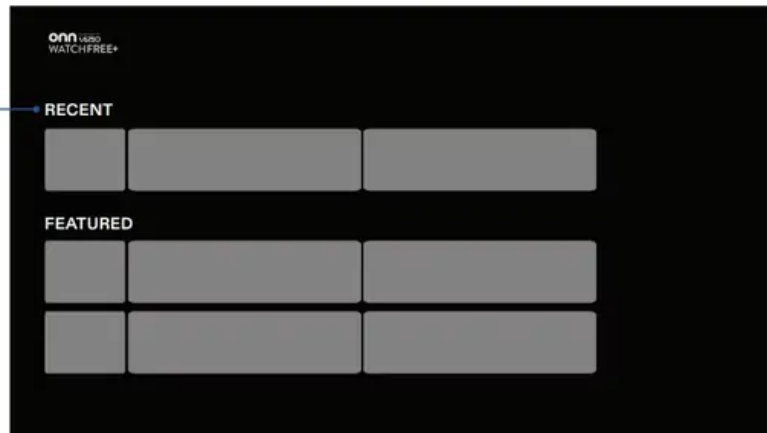

Note:
Some TV models have voice enabled remotes.



WatchFree+ Button

OK Button

Press the OK button to return to the full WatchFree+ on-screen guide. Use the up/down Navigation buttons to scroll through the guide.

For illustration purposes only.

Troubleshooting

VIZIO Home Screen is Not Available / VIZIO Home Input Not Loading / OK Button Not Working on VIZIO Home Screen

Are you having trouble with your TV displaying a message that VIZIO Home input isn't available or the VIZIO Home Screen isn't loading? Don't worry, we're here to help!

Follow these simple steps:

First, make sure your TV is connected to your network. Just go to **Menu** or  > **All Settings** > **Network** > **Test Connection**.

- If it says you're connected, you can leave the menu.
- If the network test shows that network isn't connected, or the connected speed is 0 or unavailable, don't panic! We have some handy network troubleshooting steps **right here**.
TIP: If your TV is connected to a network with an Ethernet cable, you will not see the wireless network connection menu. You must unplug the Ethernet cable to set a wireless network connection.

Next, try refreshing your VIZIO Home by clearing the cache. This is easy to do. Go to **Menu** or  > **All Settings** > **System** > **Menu Language** > **Select Spanish or French** (but don't close the menu!).

Now, wait for VIZIO Home to load. If it doesn't load, it might be due to your home network running slow.

Once VIZIO Home loads, you can switch the menu language back to English.

If VIZIO Home still doesn't load, we'll need to reset your TV. This is also easy to do. Just go **Menu** or  > **Admin & Privacy** > **Reset to Factory Defaults** > **Reset TV**.

Finally, go through the setup of your TV once again.

If you still need help, click here to reach out to our Customer Support Team. We're here to ensure you enjoy a seamless viewing experience on your TV!

WARNING: If you restore the TV to the factory default settings, all changes you have made to the settings will be lost. This includes any wireless or picture settings.

Help Topics

The remote is not responding.

- Make sure the batteries are properly inserted matching the - and + symbols.
- Replace the batteries with fresh ones.

The TV displays "No Signal."

- Look behind your TV to see where your device is connected. There will be a name next to the port you are using.
 - Make sure your device is powered on.
 - Press the INPUT button on the TV remote control and choose the port your device is connected too.
- If you are using cable TV or antenna connected directly to the TV, scan for channels.

There is no power.

- Ensure the power cable is securely attached to the TV and outlet. (Some models do not have a detachable power cable).
- Ensure the outlet the TV is connected to is working. You may want to connect another device to the outlet to ensure the devices are receiving power.
- Press the Power/Standby button on the remote or on the bottom of the TV to turn the TV on.

The power is on, but there is no image on the screen.

- Ensure all devices are connected securely and correctly. See your device's user manual for details.
- Ensure your TV is powering on. When your TV powers on, a light on the remote sensor will turn on.
- Press the MENU button on your remote control. If you can see the menu, try to adjust Brightness, Contrast, or Backlight.
- Press the INPUT button on the remote to select a different input source.

The sound is flat or dialog is not audible.

- Turn off Volume Leveling.

Where do I find information on the accessibility features of this product and other VIZIO products?

- Please visit vizio.com/accessibility,
- Email us at: Accessibility@vizio.com, or
- Give us a call at 1-877-698-4746.

How do I stream apps like Netflix to my Smart TV?

- Popular apps are located on the Home screen, so you can simply navigate to the app row on your TV to start streaming.
- You can also use Apple AirPlay 2 or Chromecast built-in to stream content from your device directly to your TV. For more information, please visit:
 - VIZIO.com/Apple
 - VIZIO.com/Google

The colors on the TV don't look right.

- Adjust the Color and Tint settings in the Picture menu.
- Select a pre-set picture mode. Calibrated is recommended.
- Check all cables to ensure they are attached.

The image quality is not good.

- Image quality can vary depending on personal preference and environmental factors like how much light is in a room. Your TV includes a variety of picture settings and preset picture modes that can be adjusted to calibrate this TV to your preference.
- Image quality can vary depending on what program you are watching, and what device or app you are using to watch it. For the best picture quality, HD or UHD recommended. You can contact your device manufacturer or app provider for more information about their video playback quality.
- For the best image quality, view high-definition programs using digital sources. Connect your devices with HDMI cables.
- If you are using an antenna, the signal strength of the channel may be low. Ensure your antenna is connected securely to the TV and move the antenna around the room or close to a window for the best signal.

The picture is distorted.

- Move the TV away from electrical appliances, cars, and fluorescent lights.
- Ensure all cables are securely attached.

The TV image does not cover the entire screen.

- Go to All Settings > Picture > Aspect Ratio to adjust the Aspect Ratio.

The buttons on the remote aren't working.

- Ensure you are only pressing one button at a time.
- Point the remote directly at the TV when pressing a button.
- Replace the remote batteries with new ones.
- Remove any obstacles that may be blocking the remote sensor on the TV.

There is no sound.

- Press Volume Up on the remote control.
- Press the **MUTE** button on the remote to ensure mute is off.
- Check the audio settings to ensure your TV speakers are set to On.
- Check the audio connections of external devices (Blu-ray player, game console, cable/satellite box) that are connected to the TV.
- If you are using an antenna, the signal strength of the channel may be low. Ensure your antenna is connected securely to the TV and move the antenna around the room or close to a window for the best signal.
- Set eARC to Off and use ARC mode.

How do I download the VIZIO mobile app?

- Make sure your phone or tablet is connected to a WiFi network. Open a browser on your phone or tablet.
- Navigate to <https://www.vizio.com/en/download-vizio-mobile> and follow the on-screen instructions to download the VIZIO mobile app.

How do I change the inputs?

- Press the **INPUT** button on the remote to cycle through the inputs.
- Make sure the VIZIO mobile app is installed on your phone or tablet. Open the VIZIO mobile app. Tap on the Device list and select your TV. Tap INPUT and select the input of your choice.

How do I connect to my WiFi network?

- On your TV remote, press the **MENU** button then go to **All Settings > Network > Select your WiFi name > Enter password.**

How do I exit Demo Mode?

- Press the **BACK** button on the remote and then select **Exit Demo** and press **OK.**

How do I watch Cable/Antenna TV channels?

- If you subscribe to cable or satellite, simply connect an HDMI cable (not included) to the receiver.
- If you use external antennas to watch local broadcast channels, use a coaxial cable to connect.

Some of my Channels are missing.

- Press the **MENU** button on your TV remote, then go to All Settings > Antenna Channels > Find Channels.
- Open the VIZIO mobile app on your phone or tablet.
 - Click on: Menu Tab > Devices > Your TV/Device Name > Channels > Find Channels.

How do I disable/enable Viewing Data?

- Press the MENU button on your remote to go to All Settings > Admin & Privacy, then select Viewing Data to turn the feature on or off.

The television will not turn on using Alexa or Google Assistant.

- Ensure the television is in Quick Start Mode.
- Press the MENU button, then go to All Settings > System > Power Mode > Quick Start.

How do I know I am getting 4K resolution or HDR content such as Dolby Vision? (for 4K models only)

- As you are watching content on the television, press the INFO button on the remote or VIZIO mobile app. You will see the current resolution being displayed along with the version of video.
- HDR will show as a Dolby Vision icon, HDR10 or HLG.

Warning

This content is compiled from multiple sources and is provided for reference purposes only. It may not be complete or fully applicable to all situations. If you are unable to resolve your issue, please contact the product manufacturer or an authorized service provider for official support.