

## SPECIFICATIONS

Name	Vacuum Cleaner
Model	L12E
Adapter Input Voltage	20V~240V 50/60Hz
Adapter Output Voltage	26V 0.5A

## WHAT'S IN THE BOX

CAUTION: Assemble the vacuum according to the "Assembly" section.

Vacuum main body

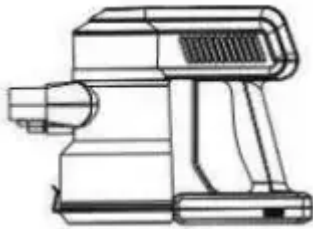

Floor Brush

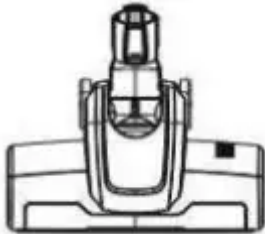

2-in-1 brush

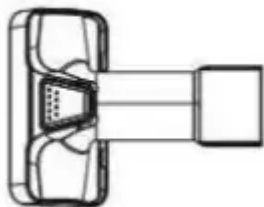

Wall hanger

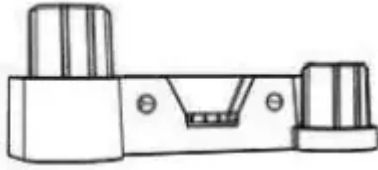

Screws and wall anchors



HEPA filter



Crevice tool



Fam-Iner Meta Tube

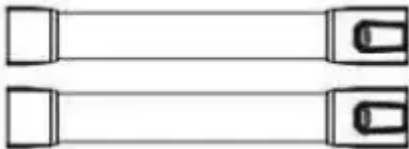

Adapter



# CLEANING AND MAINTENANCE

## Clean the HEPA filter

1. Hold and turn the HEPA filter clockwise to detach it.



2. Pull up the HEPA filter out of the mesh shell.



3. Brush the HEPA filter with cleaning brush before rinsing it.



4. Rinse both the HEPA filter and the mesh shell under tap water.



5. Air dry them for at least 24 hours. Do not assemble it back until completely dry.



### CAUTION:

1. Do not assemble HEPA filter back until they are completely dry.
2. Turn it anticlockwise to assemble them back.



Filter is suggested to be washed (air dry before installing back) every 2 weeks. to be replaced every 2 months. otherwise. it will result in insufficient filter system and loss of suction.

### Clean the Exhaust Filter

1. Press two buttons at both sides of the exhaust filter at the same time.



2. Lift to detach the exhaust filter from the vacuum.



3. Use the cleaning brush to clear dust on the exhaust filter.

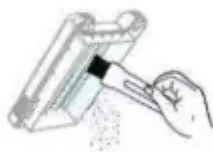

4. Rinse the exhaust filter under running water.

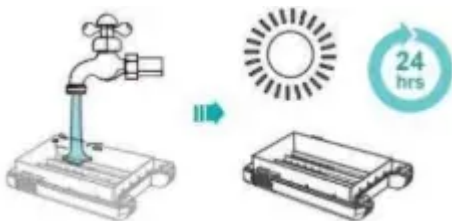

5. Air dry the exhaust filter for at least 24 hours. Do not assemble it back until it is completely dry. Attach the exhaust filter back to the vacuum. A "click" will be heard if it fits

well.



## Clean the Floor Brush

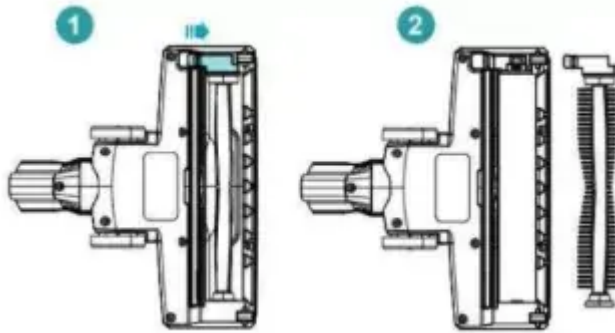

1. Switch off the product and detach the floor brush.
2. Lift up the roller and take it out.
3. Clean any dust and remove entangled hair or debris.
4. Place back the cleaned roller.

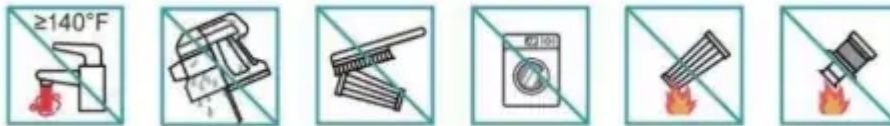

## CLEAR A CLOG

**CAUTION:** It is important to fully charge your machine before using it for the first time and after every use.

Check the floor brush and clear the clog on the roller brush with the blade.

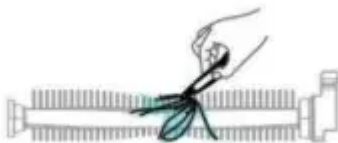

Check if there are any clogs inside the telescopic tube.

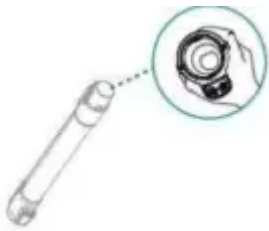

Check and empty the dust cup.



Check and rinse the HEPA filter. Do not assemble them until completely dry.



## IMPORTANT SAFETY INSTRUCTIONS

When using an electrical appliance, basic precautions should always be followed, including the following: READ ALL INSTRUCTIONS BEFORE USING (THIS APPLIANCE)

**WARNING:** TO REDUCE THE RISK OF FIRE, ELECTRIC SHOCK, DAMAGE, OR INJURY:

1. To protect against electrical shock, do not immerse the power cord or plug in water or any other liquid. Please always operate it with dry hands to avoid the risk of electrical shock or serious personal injury.
2. Close supervision is necessary when any appliance is used by or near children. This vacuum is not intended for use by persons (including children) with reduced physical, sensory, or mental capabilities, or lack of experience and common sense unless they are supervised or have been given instructions on using the vacuum by a person responsible for their safety.
3. Do not use the vacuum outdoors. It is for household use only.
4. Do not use the vacuum if it has been dropped, damaged, left outdoors, or dropped in water. Please contact customer service for help when the appliance or the adapter is damaged.

5. Use the vacuum only as described in this manual. The use of accessory attachments not recommended may cause damage to the vacuum or personal injuries.
6. Do not use abrasive materials to clean the vacuum. Do not use spirits or other solvents to clean the appliance.
7. Do not use the appliance to vacuum any of the items below:
  - Water, flammable, or combustible liquids such as gasoline.
  - Lighted stubs, matches, hot ashes, or other combustible items.
  - Needles, pins, or other sharp items.
  - Wood pieces, gesso, cement, calcimine, or other tiny granules.
  - Pieces of string or fabric.
8. Do not pick up liquids with the vacuum or use it on wet floors. Do not immerse the vacuum in water.
9. Do not use the vacuum on concrete, tar, or similar rough surfaces.
10. Do not vacuum frayed carpets or carpet tassels.
11. Do not use the vacuum without the dust cup lid in place.
12. Do not put any objects into openings of the vacuum. Do not use when any openings are blocked. Keep free of dust, lint, hair, or anything that may reduce air flow.
13. Keep hair, loose clothing, fingers, and all body parts away from openings and moving parts.
14. Store the vacuum indoors. Store after use to prevent accidents.
15. Keep the vacuum cleaner away from stoves and heat-emitting appliances. Heat can deform and discolor the plastic parts of the unit. Please use the vacuum at the temperatures between 14°F-104°F.
16. Always remove the adapter from the power socket when the appliance is not being charged.
17. Unplug charging cord from the appliance and power it off before cleaning or performing maintenance, making tool adjustments, changing accessories, or storing, to avoid powering it on accidentally.
18. The battery must be removed from the appliance before disposing of it.
19. The battery must be disposed of safely.
20. The appliance includes Li-ion batteries. Do not incinerate the batteries or expose them to high temperatures, as they may explode.
21. The thermal cutout will switch off the vacuum automatically when it overheats. If this happens, turn off the power switch, and wait for 45 minutes to restart the vacuum.
22. Use only the adapter provided by the manufacturer.

Do not vacuum large piece of paper. [IMAGE] Do not vacuum fire or flammable substances. [IMAGE] Do not vacuum water or liquids. [IMAGE] Do not remove plug by grasping the cord. [IMAGE]

## INDICATOR LIGHT INSTRUCTION

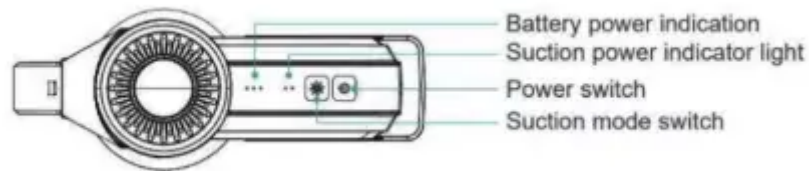

**The battery indicator light:** With more lights on, the higher the power is.

- When the vacuum gets charged, the battery indicator will be in a cycle of illuminating. When the vacuum gets fully charged, all three lights will be solid on.
- When all the indicator lights quick flash during charging, please stop charging immediately and replace the adapter with original one.

**Suction power indicator light:** There are two indicator lights of the suction mode. The more indicator lights are on, the more powerful suction is.

**Suction mode switch:** press the button to switch the suction gear.

**Power switch:** Press the button to turn on and off the machine.

## BATTERY CHARGING



1. Connect with charging inlet which is at right side of cleaner body.
2. No.1. 2. 3 lights keep flashing on during charging. When battery is fully charged, 3 lights will all be solid on until the adapter is unplugged.

**Attention: The appliance must be power-off during charging.**

Please charge the appliance at the temperature of 32°F-113°F. Higher and lower temperature could prolong the charging time or even damage the battery. The battery would stop charging if the temperature is higher than 113°F.

It usually takes 4-5 hours to charge the battery fully. Please charge fully before the first use. Please charge and discharge the battery fully once three months when you won't be using it for a long time for keeping battery function normal.

**Disposal:**

The chemical substances contained in the built-in lithium-ion battery of this product will pollute the environment. Before scrapping the product, the battery must be removed and handed over to a professional waste battery recycling station for disposal. Do not dispose of old electrical appliances with household waste discard.

Before disposing of your old machine, remove the dust cup and inner dust cup filter assembly, which can be disposed of with normal household waste.

**CAUTION:**

1. When discarding the machine, the battery pack must be removed and disposed of properly, according to your area battery disposal regulations or the universal waste management rule. Batteries contain materials that are harmful to the environment.
2. Discarded batteries should be handled properly. Don't put them into water, fire, or soil.
3. If the battery leakage touches skin or eyes, flush with water immediately and seek the professional medical help.



# TROUBLESHOOTING



<b>Problem</b>	<b>Cause</b>	<b>Solution</b>
The vacuum can not be charged	The used adapter is not the original one	Please charge the vacuum with the original adapter
	The battery pack/ adapter malfunctions	Please contact the customer service for help
The vacuum runs out of power quickly/The working time is short	The battery runs out	Please charge the vacuum with the original adapter. It is recommended to charge the vacuum after each time use and use the low suction mode for long runtime
	The floor brush gets stuck	Clean foreign objects entangled on the floor brush
	1. The air duct is blocked 2. The dust cup is full	Clean the floor brush. telescopic tube. dust cup and the HEPA filter regularly
	Other malfunctions	Please contact the customer service for help
The cleaning results are not good	The battery runs out	Please charge the vacuum fully and try to turn it on again
	Incorrect use of the product	1. It is recommended to use high suction mode for cleaning complicated environments 2. It is recommended to use the crevice tool for better pickup for vacuuming heavy objects such as beans 3. It is recommended to use the floor brush for cleaning hard floors
	1. The air duct is blocked 2. The dust cup is full	Clean the floor brush. telescopic tube. dust cup and the HEPA filter regularly
	The HEPA filter is not dried completely	Detach and air dry the HEPA filter completely. It is recommended to clean and replace it regularly
There is static during vacuum working		Please empty the dust cup

	There is too much dust inside the dust cup	
	The vacuum runs at an environment full of static	It's normal that there may be much static in the air in winter and dry regions
The electric floor brush stops working	The floor brush gets stuck	Clean foreign objects entangled on the floor brush
	Other malfunctions	Please contact the customer service for help

## WARRANTY

### CUSTOMER CARE

The 1-year Limited Warranty is valid for Products.

If your machine is used correctly according to the instruction manual and there is a quality failure during the warranty period, we will provide you with free warranty service once you contact us.

\*If service parts are no longer available or discontinued, they will be replaced with functional replacements.

### WHAT IS NOT COVERED

1. Under your machine guarantee, warranty shall not be liable for costs of repair or replacement of a product incurred as a result of: Accidental damage, faults caused by negligent use or care, misuse, neglect, careless operation or any handling of the appliance which is not in accordance with this Instruction Manual.
2. Machines purchased from an unauthorized dealer.
3. Use of parts and accessories other than those produced or recommended by unauthorized parties or agents.
4. Repairs or alterations carried out by unauthorized parties or agents.
5. Use of the machine other than for normal domestic purposes, e.g. for commercial or rental purposes.
6. Reduction in battery run time due to battery age or usage.

### WARRANTY SERVICE

1. If you have a query about your appliance, please contact customer service at: [usa@imoosoo.com](mailto:usa@imoosoo.com)

2. Please inform us of your model name/number. purchased date. order number. machine malfunction details and your request for reparations.
3. Your model number can be found on the rating plate.
4. Please keep your purchase receipt in a safe place to ensure you have this information.

Service rendered under this warranty will not extend the term of the warranty.

**Warning**

This content is compiled from multiple sources and is provided for reference purposes only. It may not be complete or fully applicable to all situations. If you are unable to resolve your issue, please contact the product manufacturer or an authorized service provider for official support.

---

Document generated by [ManualsFile](#)

