

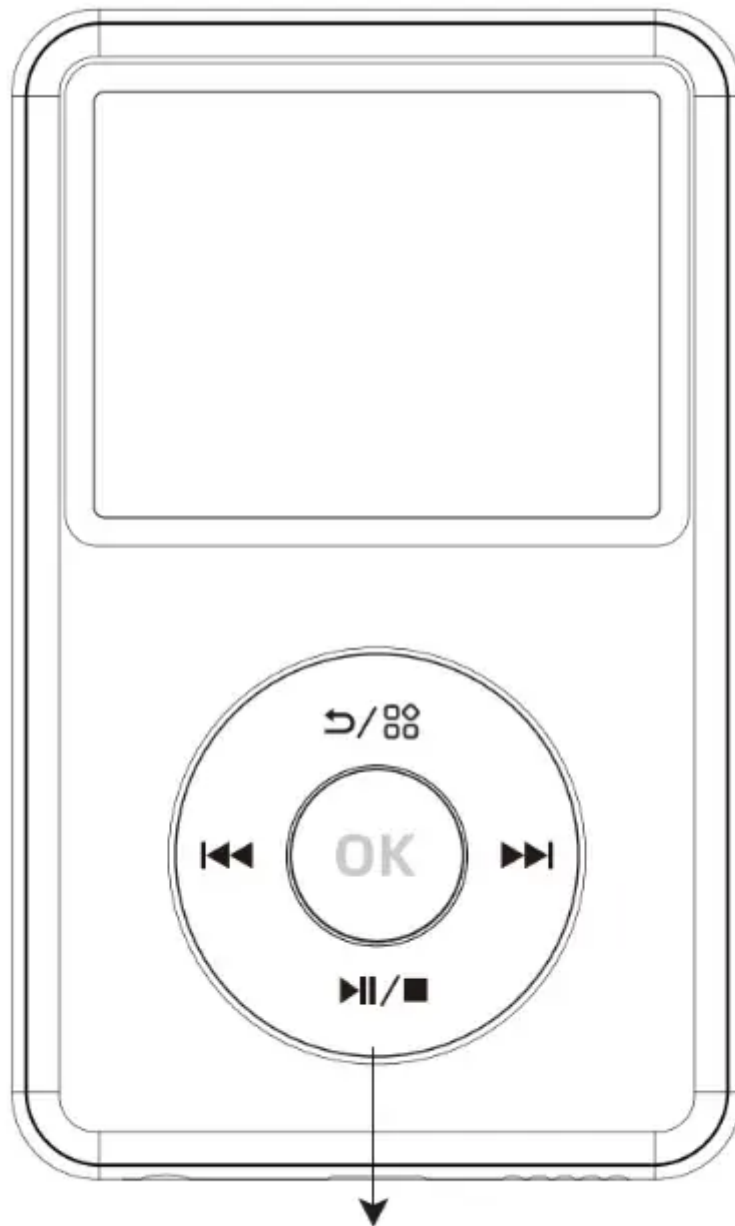

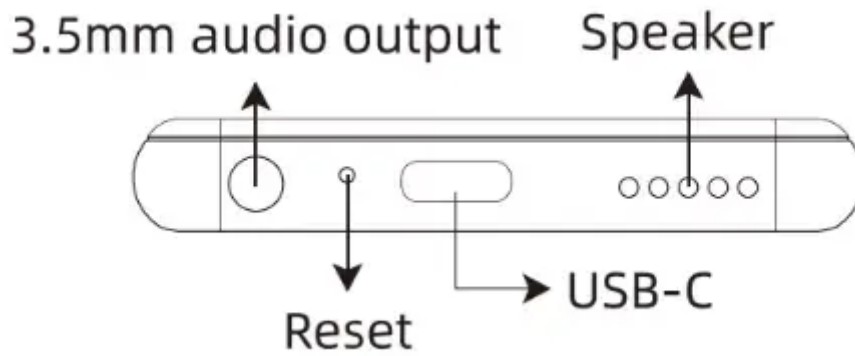



INNIOASIS Y1 MP3 Music Player



Click wheel



Click Wheel

-  **Return / MFB (Multi-Function Buttons)**
Short press to go back to the previous page. long press to activate certain specific functions or shortcut menus. such as A-B repeat. bookmarks. etc.
-  **Previous (Rewind)**
Short press to skip to the previous track. long press for fast rewind.
-  **Next (Forward)**
Short press to skip to the next track. long press for fast forward.
-  **Play(Pause)/Stop**
Short press to play or pause. long press to stop playback.
-  **Volume +/- or switch options**
Swipe clockwise to increase volume or scroll down or right options.
Swipe Anticlockwise to lower volume or Scroll up or left options.
-  **OK / Power ON(OFF)**
Short press to confirm the current option.
Long press for 3 seconds to power on (off).

Ports and Features

3.5mm audio output

Connect external headphones or speakers.

USB-C

Connect to a computer or adapter for charging or files transfer.

Speaker

Built-in speaker for audio output.

Reset Hole

Reset hole is used to force shutdown the device in case of freezing or crash (not reset to factory settings).

How to transfer music to the player

1. Connect Y1 player to your computer with the included USB-C cable.
2. Short press the button  on Y1 player to confirm "Turn on USB storage".
3. Click "This PC" on your computer's desktop. you will find a USB drive added to the list of devices and drives.



4. Copy the music that has been downloaded on the computer and paste it into this newly added USB drive.
5. After completing the file transfer, click the button  again to turn off USB storage, and press »/38 to return to

Tips: If you turn on USB storage, some apps you're running will stop and may be unavailable until you turn off USB storage.

Main Menu Options

List all functional options of the Y1 player, including: Now Playing, Music, Audiobook, Bluetooth, Settings, Shuffle Quick.

The following actions are available on the click wheel:

Key	Action	Result
	Swipe clockwise	Scroll down or right options
	Swipe Anticlockwise	Scroll up or left options
	Short press	Confirm selected option
	Long press	Power on or power off

Now Playing

Quickly enter the playback interface to view the currently playing song or audiobook.

The following actions are available on the click wheel:

Key	Action	Result
⏮	Short press	Prev track
	Long press	Fast rewind
⏭	Short press	Next track
	Long press	Fast forward
⏪/🔊	Short press	Back to Prev-level
	Long press	Activate bookmark (for audiobook) / Activate A-B repeat (for music)
▶/■	Short press	Play / Pause
	Long press	Stop playing
🕒	Swipe clockwise	Volume +
	Swipe Anticlockwise	Volume -
OK	Short press	Switch between song info and lyrics
	Long press	Power on or off

FAQs

1) How to shuffle?

In "Setting - Shuffle". switch the status to On.

2) How to get list loop?

In "Setting - Repeat". switch the status to "List loop".

3) How to view lyrics?

In the Now playing window. short press  to switch to lyrics display. Short press again to return to the song information display.

4) Can I add a bookmark to audiobooks?

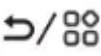
Yes. When playing audiobooks. long press the key  to pop up the dialog box. and then confirm to add to bookmark. All created bookmarks are preserved in Audiobook --- Bookmark lists.

5) Is there A-B repeat?

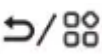
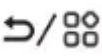

A-B repeat is only available for music playing. When playing music. long press the key  to activate A-B repeat and generate point A. long press the key  again to generate point B.

* If you want to use A-B repeat while playing audiobook. please do not store the audiobook file in the Audiobooks folder. By default, only files stored in the "Audiobooks" folder are recognized as audiobook. while those stored in other folders are recognized as music.

6) Is the player equipped with an equalizer and how to use it?

Yes. Y1 is equipped with EQ. You can go to Settings -- Equalizer to select your favorite preset style. or long press the key  to activate the customized EQ.

Music

Key	Action	Result
	Swipe clockwise	Scroll down or right options
	Swipe Anticlockwise	Scroll up or left options
	Short press	Confirm selected track or option
	Long press	Power on or Power off
	Short press	Back to Prev-level
	Long press	Activate shortcut

About shortcut menu

Long press the key  in all folders under Music to pop up a shortcut menu for file management:

- **Multi Select** -- Select music / file one by one.
- **All Select** -- One-click to select all music / files in the current folder.
- **Delete File** -- Delete the selected music.
- **Add to Playlist 1,2,3...** -- Add selected music to target playlist.

About Playlist

Y1 Player allows you to add. delete. rename playlists. Long press the key  in the playlist folder to pop up the shortcut menu. and then select the operation you want:

- **New Playlist** — add a new playlist, the default name of the new playlist is Playlist 6, 7...
- **Delete Playlist** — delete the current playlist.
- **Rename** — Rename the current playlist.

About Search



Y1 Player allows you to search for a target track or album by part or all of the song title. Click “Search” and enter some or all of the song names in the pop-up input box to preview the search results above the input box.

For more operations. please refer to the table below:

Key	Action	Result
⏮	Short press	backspace - deletes one character per press
	Long press	Continuous delete
⏭	Short press	Space - Enter a space
	Long press	Fast forward
🔄	Swipe clockwise	Scroll down or right letter options
	Swipe Anticlockwise	Scroll up or left letter options
OK	Short press	Enter the current letter
	Long press	Power on or off
🔍	Short press	Close the input box and return to search
	Long press	Activate shortcut menu

In search results page. long press the key 9/88 to pop up a shortcut menu. which allows you to select all or multiple tracks and add them to the target playlist.

Audiobook

Key	Action	Result
	Swipe clockwise	Scroll down or right options
	Swipe Anticlockwise	Scroll up or left options
	Short press	Confirm selected book or option
	Long press	Power on or off
	Short press	Back to Prev-level
	Long press	Activate shortcut menu

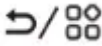

Note: Only books stored in the device's "Audiobooks" folder are recognized as audio books. Audiobooks stored elsewhere will be recognized as music.

About shortcut menu

Long press the key  in all folders under Audiobook to pop up a shortcut menu for file management:

- **MultiSelect** -- select music / file one by one
- **All Select** -- one-click to select all book / files in the current folder.
- **Delete File** -- delete selected music.

About Bookmark lists

In the audiobook playback window. long press the button  to activate the bookmark function. and all created bookmarks are saved in this list. Long press the button  in the bookmark list to pop up a shortcut menu. allowing you to select all. multi select. and delete bookmarks.

About Settings

Note: these settings under Audiobook are only available for playing audiobooks.

- **Shuffle** -- enable/disable shuffle mode
- **Repeat** -- enable/disable loop playback. Options include: List loop. Single loop. Off.
- **Speed** -- Adjust playback speed. Options include: Slow. Normal. Fast. Fastest.
- **Time off** -- Set stop playing time. Options include: Off. 10min. 20min. 30min. 60min.

FAQs

1) How to add a bookmark?

When playing the audiobooks. press the key  in the click wheel to pop up the dialog box. and then confirm to add to bookmark. All created bookmarks are preserved in Audiobook --- Bookmark lists.

2) Why didn't I find the audio books uploaded to the device?

To avoid confusion between music files and audiobooks. only books stored in "Audiobooks" folder will be recognized as audiobooks by default. Books stored elsewhere will be recognized as music. Therefore. make sure you upload the audiobooks to the audiobooks folder.

Tips: encrypted audiobooks cannot be recognized. such as .m4b. aax file.

FM Radio

Key	Action	Result
	Short press	Prev channel
	Short press	Fast channel
	Short press	Back to Prev-level
	Long press	Activate shortcut menu
	Short press	Play / Pause
	Swipe clockwise	Volume + / Scroll down or right options & frequency
	Swipe Anticlockwise	Volume - / Scroll up or left options & frequency
	Short press	Switch between song info and lyrics
	Long press	Power on or off

About shortcut menu

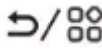
In the radio broadcast window, long press the key  to pop up the shortcut menu:

- **Play** -- Play the current channel
- **Pause** -- Pause playback.
- **Channel List** -- List all saved channels for auto search and manual search.
- **Frequency Range** -- Change frequency area, options included: America, Asia, Australia, Europe, Japan.

- **Re-search Channel--** Start Auto Channel search.
- **Audio output** -- Change the audio output mode: Headset, Speaker, Short press  key to switch.
- **Record FM--** Turn on radio recording to record your favorite radio and programs. All recordings will be stored in the “Recording files” folder by default.

FAQs



1) Is wired headset required as antenna to use FM radio?

Yes. you must connect a wired headset to start FM Radio.



2) Is Bluetooth headphone available for FM?

Of course. It is recommended that you plug in a wired headset and start FM before connecting your Bluetooth headset. Because the default audio output terminal of the player is the last connected device.





3) How to search for a station manually.

In the FM window, short press the key  to call up the manual channel search, and then slide the click wheel counterclockwise or clockwise to adjust the frequency to the best. To save the channel. short press .

4) Can I record FM radio and how?





Long press the key  to activate the shortcut menu, then select Record FM to start recording the current station. While recording, the upper left corner of the FM window displays a flashing recording logo. To save the recording, short press the key  and confirm to save.

Photo

Key	Action	Result	
		In Folder List Window	In Picture Browse Window
	Short press	Prev folder or file	Prev picture
	Short press	Next folder or file	Next picture
	Short press	Back to Prev-level	Back to pre-level
	Long press	Activate shortcut menu	Activate shortcut menu
	Swipe clockwise	Scroll down or right option and file	Switch down or right picture
	Swipe Anticlockwise	Scroll up or left options	Switch up or left picture
	Short press	Confirm selected option or file	Exit picture browsing
	Long press	Power on or Power off	Power on or Power off

About shortcut menu

In the folder and picture list window and picture browsing window. long press the key 9/88 to activate the shortcut menu. You can use it to:

-  **Delete** -- Delete the selected folder / file / picture.
-  **MultiSelect** -- Activate the multiple selection function and select files one by one.
-  **All Select** -- Select all folders or files at once.
-  **Rename** -- Rename the current folder or file.
-  **As Wallpaper** -- Set the current picture as desktop or global wallpaper.

FAQs

1) Why do I get a very blurry desktop background when I set the picture as wallpaper?

First make sure your picture pixels are greater than 480 x 360. then go to Settings – Wallpaper, and switch the value of Ground glass to Off.

2) What image formats are compatible with the player?

Both .PNG and .JPG are available.



3) Can I edit the picture?

Only rename is available, no picture editing option is provided.

4) How to operate the input keyboard when renaming?

Please refer to “About Search” in the Music section.

Bluetooth

Key	Action	Result
	Short press	Back to Prev-level
	Long press	Ignore My Device
	Swipe clockwise	Scroll down or right options
	Swipe Anticlockwise	Scroll up or left options
	Short press	Confirm option / Connect or Disconnect
	Long press	Power on or Power off

FAQs

1) How to connect or disconnect devices?

Connect: After enabling Bluetooth, all available Bluetooth devices around will appear under other devices. Swipe the click wheel counterclockwise or clockwise to locate the target device, and then short press  to pair and connect with the device.

Disconnect: Swipe the click wheel counterclockwise or clockwise to locate the connected device in My Device. Short press  and confirm to disconnect the device.

2) How to remove a device from my device?





Swipe the click wheel counterclockwise or clockwise to locate the target device in My Device. Long press  and confirm to remove the device.



3) How to refresh the device list?

Turn Bluetooth off and back on.

Settings



Key	Action	Result
⏪/⏮	Short press	Back to Prev-level
○	Swipe clockwise	Scroll down or right options
	Swipe Anticlockwise	Scroll up or left options
OK	Short press	Switch & confirm setting value
	Long press	Power on or Power off

- **Clear cache** -- Clearing the system cache resolves common issues such as unexpected slow performance, response delays, or crashes.
- **Timed shutdown** -- Set the time of timed shutdown, options included: off, 10min, 20min, 30min, 60min, 90min, 120min. Short press  to switch.
- **Shuffle** -- shuffle on or off. Short press  to switch. (Only available for music, not for audiobooks)
- **Repeat** -- Change the loop mode: off, list loop, single loop. Short press  to switch. (Only available for music, not for audiobooks)
- **Equalizer** -- Provide 10 preset style: Normal, Classical, Dance, Flat, Folk, Heavy Metal, Hip Hop, Jazz, Pop, Rock. And allow customization of EQ.
Tips: The currently running style is marked with green, and the style being located is marked with light blue.
- **Sort by** -- Sort files or tracks by file name or creation time. Options include: Name A to Z (ascending), Name Z to A (descending), Time, Time reversal.
- **Key lock** -- Enable or disable keylock.
 - **On** -- In the power-saving mode (screen off), the device will execute the corresponding command only if you press the key  to wake up the screen, and then press other function keys. It prevents accidental key presses from interrupting playback, unpausing or skipping tracks.
 - **Off** -- In the power-saving mode (screen off), pressing any function key will immediately execute the corresponding operation command without waking up the screen. This means that accidental key presses may cause playback to be interrupted, pause to be cancelled, or tracks to be skipped. Need to wake up the screen, just press the key .

- **Key tone** -- Enable or disable key tone. Short press  to switch.
- **Key vibration** -- Enable or disable key vibration. Short press  to switch.
- **Wallpaper** -- Change the wallpaper of the device desktop or global.
Note: Setting "Ground glass" to "On" will blur the wallpaper.
- **Backlight** -- Adjust backlight time: 10s. 15s. 30s. 45s. 60s. 2m. 5m. Always. Short press  to switch. When the device is idle for more than the set time. the screen will turn off and enter power-saving mode.
- **Brightness** -- Adjust screen brightness by sliding the click wheel clockwise or counterclockwise.
- **Display battery** -- Select whether to display the battery percentage in the title bar.
- **Date & Time** -- Set the date. time. and time format of the device. etc.
- **Language** -- Set the language of the device.
- **Factory reset** -- Reset the device to factory settings.
Warning: all saved files on the device will be deleted. Please be careful.
- **About** -- view device information.

Settings FAQs

1) How to use custom EQ?

Navigate to any preset style under Settings--Equalizer. and long press the key  to activate the customized EQ. Then press  to switch to the band to be adjusted. And swipe  clockwise or anticlockwise to change the value of this band. If you are not satisfied with the current customization. you can select "Reset" to restore to the default.

2) How did shuffle and repeat work together?

Shuffle	Repeat	Result
On	Off	Shuffle in the current playlist or folder. stop after all songs are played
	List loop	Shuffle in the current playlist or folder. continue to shuffle after all songs are played
Off	Single loop	Loop the current track
	Off	Play sequentially in the current playlist or folder. stop after all songs are played
	List loop	Play sequentially in the current playlist or folder. continue to sequential play after all songs are played
	Single loop	Loop the current track.

Shuffle Quick

Quickly select a song randomly and start music playing.

Specifications

Bluetooth version: 4.2

Product Size: 3.8 x 2.4 x 0.3 inch

Weight: 2.3 oz

Screen Size: 2.4 inch (480 x 360 pix)

Battery Capacity: 1250mAh

Charging Time: 90 Minutes

Storage: 128 GB

Music Playtime: 25-35 hours

Music format: MP3. WAV. FLAC. APE. OGG. M4A. AAC. WMA. MP2. AMR. MID. M4R. MMF. WV. AIF. AIFF. AU. RA. MKA. AC3. CAF

Photos format: JPG. PNG

FM Receiving Frequency: 87.5 MHz ~ 108 MHz

Warning

- >> Do not leave the device in an environment where the temperature is too low or too high (below -10°C or above 50°C) for a long time. Extreme temperature environments will cause the device to deform and shorten the service life of the device;
- >> Do not use the equipment under thunderstorm weather;
- >> Do not place the device in the water for a long time;
- >> Do not expose the equipment to the sun for a long time.

Warranty and Service

Thank you for purchasing our products. You will enjoy the following services when using this product.

Warranty period: Within one year from the date of sale.

Warranty scope: Limited to the product host.

Warranty terms:

(1) Within 1 year after purchase. failure or damage caused by product quality problems can be replaced for free or full refund.

(2) Accessories are not included in the warranty. such as USB cable. earphones. etc.. but if quality problems occur within 7 days after purchase. they can be replaced for free.

(3) The following conditions are not covered by the warranty:

- Out of the warranty period.
- It has been disassembled or repaired privately by the customer.
- Man-made damage. accidental damage or deformation.
- Failure caused by installation and use in abnormal environments such as high temperature. high pressure. and humidity.
- Damage caused by natural disasters such as lightning strikes. floods. and earthquakes.

Warning

This content is compiled from multiple sources and is provided for reference purposes only. It may not be complete or fully applicable to all situations. If you are unable to resolve your issue, please contact the product manufacturer or an authorized service provider for official support.