



IMPORTANT SAFETY INSTRUCTIONS

General Safety

1. Children shall not play with the appliance. Cleaning and maintenance shall not be performed by children without supervision.
2. Use the appliance as described in the user manual only. Any other use not recommended in the user manual may cause fire, electrical shock, or personal injury.
3. This appliance can be used by children aged above 8 years and persons with reduced physical, sensory or mental capabilities or lack of experience and knowledge if they have been given supervision or instruction concerning use of this appliance in a safe way and understand the hazards involved.

Operation Safety

1. Always place this appliance on a firm, flat and level surface to avoid dropping or tilt.
2. Always place this appliance 2 feet (60 cm) above the floor, 12 inches (30 cm) away from the wall or wooden furniture.
3. DO NOT move this appliance while it is on.

4. DO NOT attempt to repair any parts on this appliance. Doing so will void your warranty. The inside of this appliance contains no user serviceable parts. All servicing should be performed by qualified personnel only.

Electricity Safety

1. Make sure that the voltage of your electricity supply is the same as that indicated on the appliance.
2. Always unplug before cleaning or leaving the appliance unused for a long period of time. Keep your hands dry when plugging/unplugging.
3. To avoid fire hazard, NEVER put the cord under rugs, near heat registers, radiator, stoves or heaters.
4. Do not use this appliance if the cord has been damaged to avoid fire or electric hazard.
5. Keep the cord out of heavy traffic areas and where it will not be tripped over.
6. Do not operate any humidifier with a damaged cord or plug. Discard the appliance or return to an authorized service facility for examination and/or repair.
7. Do not run cord under carpeting. Do not cover cord with throw rugs, runners, or similar coverings. Do not route cord under furniture or appliances. Arrange cord away from traffic area and where it will not be tripped over.
8. WARNING: To reduce the risk of fire or electric shock, do not use this humidifier with any solid-state speed control device.
9. This appliance has a polarized plug (one blade is wider than the other). To reduce the risk of electric shock, this plug is intended to fit in a polarized outlet only one way. If the plug does not fit fully in the outlet, reverse the plug. If it still does not fit, contact a qualified electrician. Do not attempt to defeat this safety feature.

FOR HOUSEHOLD USE ONLY

Gentle Reminder

Check the appliance regularly and refer to TROUBLESHOOTING or contact our customer support if it shows any of the following signs:

- Power cord or plug is damaged.
- Loud noise, unusual smell or excessive heat.

Specifications

Model	DR-HHM001
Input	AC 120V 60Hz
Rated Power	26W
Water Tank Capacity	4L

KNOWING YOUR HUMIDIFIER

Package Contents

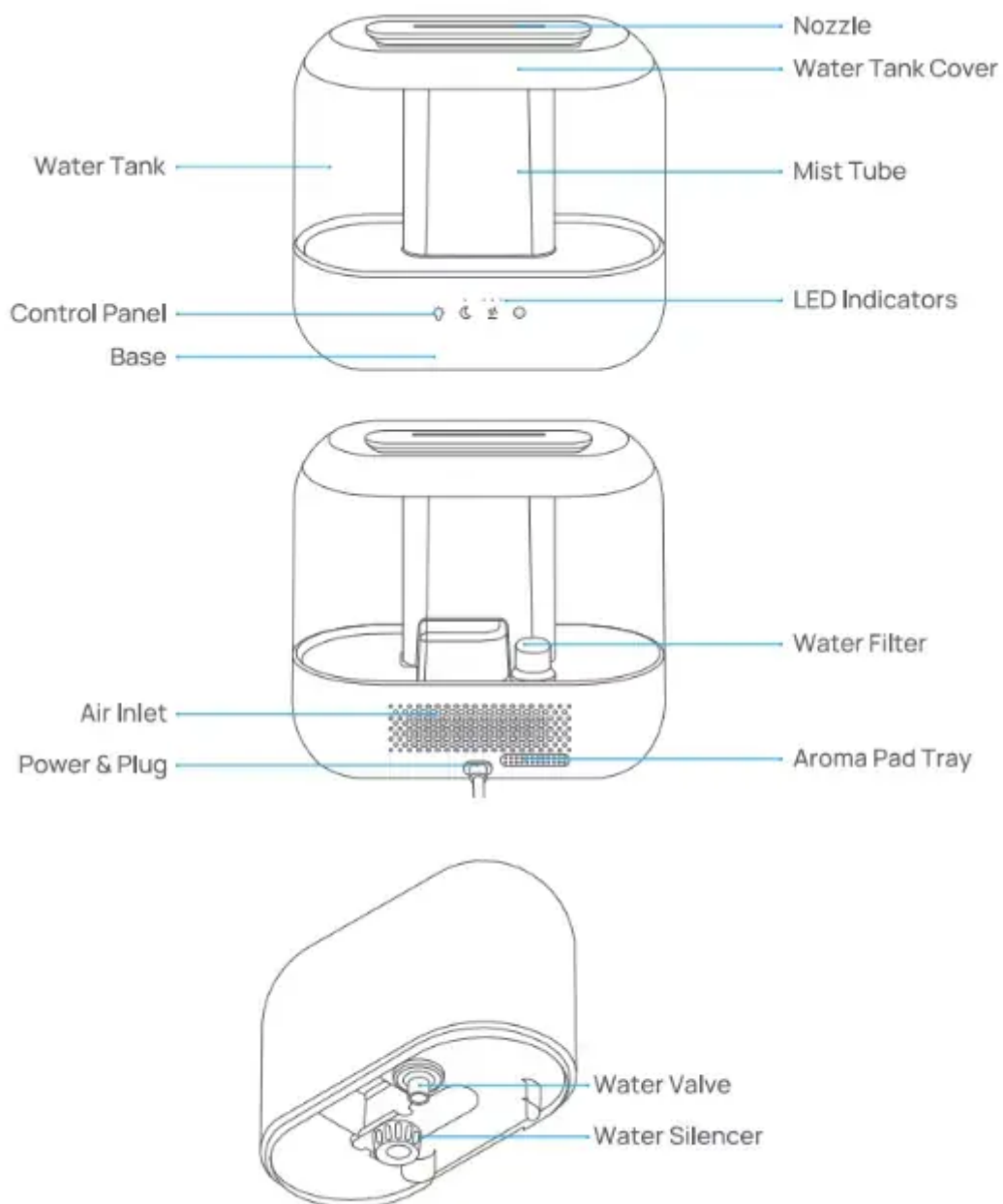

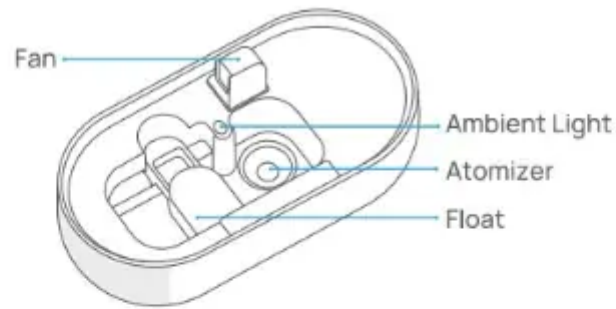

Control Panel

	<p>Power Button Turn the humidifier on/off</p>
	<p>Manual Mode Button Switch between Low/Medium/High mist level</p>
	<p>Sleep Mode Button Turn on/off Sleep Button</p>
	<p>Ambient Light Button Switch between -> High Brightness -> Low Brightness -> Off</p>

USING YOUR HUMIDIFIER

Before Use

When using your humidifier for the first time, remove the wraps and follow the steps below.

1. Make sure the water filter is installed correctly and the yellow label has been removed.

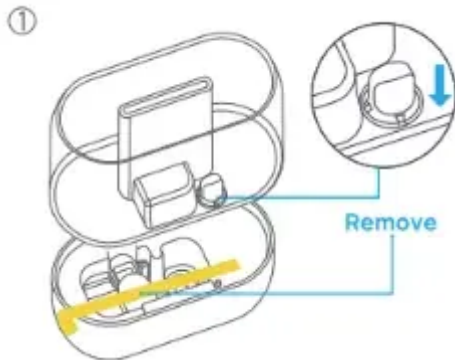

2. Detach the cover and water tank from the humidifier and clean thoroughly.

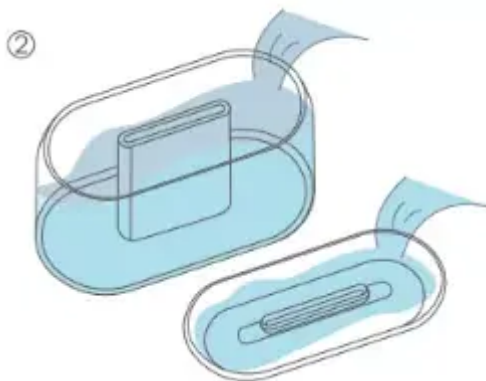

3. Fill the tank with water, making sure the water doesn't pass the MAX line.

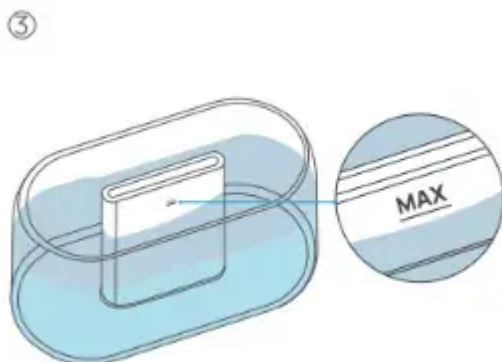

4. Put the water tank back in place and close the top cover.

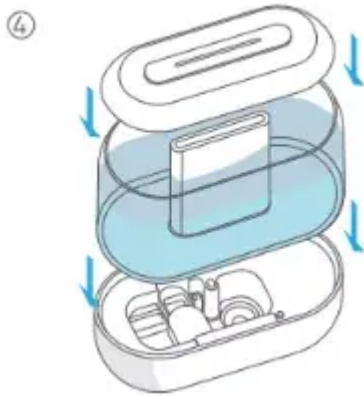

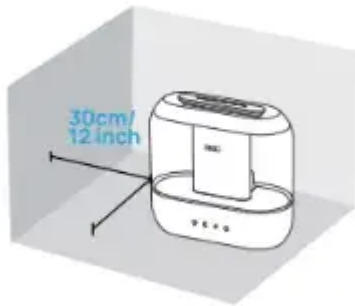

5. Place the humidifier on a flat, level surface, keeping at least 30cm / 12 inch away from walls or any major obstacles.





ATTENTION:

- It is recommended to add purified or distilled water to prevent white powder residue from forming.
- Do not add essential oil into the water tank to avoid damage to the tank.
- Do not place the humidifier on the carpet or floor directly.
- Direct the mist away from walls, furniture and electrical appliances.
- It is recommended to place a water-resistant mat under the humidifier to catch spills and droplets.



General Operations

1. Plug the humidifier into an electrical outlet.
2. Touch  to turn on/off the humidifier.
3. Touch  to choose your desired setting:

		
Low	Medium	High



Note: When the water is low, the high mist level indicator will flash red for 5 seconds, then the humidifier will switch to standby.

	Sleep Mode	<ul style="list-style-type: none">• The humidifier will switch to low mist.• LED indicators and night light will be turned off.
	Ambient Light Mode	Turns on/off the night light.

4. Adjust the direction of the mist. You can rotate the nozzle front or backwards up to 15°.

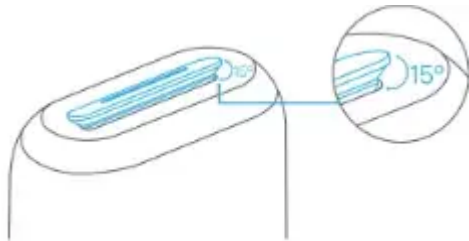

Adding Essential Oil

1. Push to open the aroma pad tray.

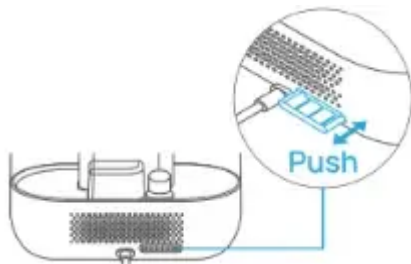

2. Add 5-10 drops of essential oil on the aroma pad.



3. Put the aroma pad tray back in place.

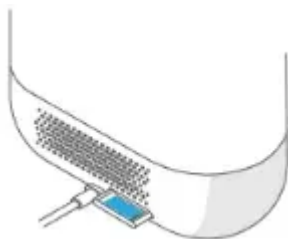

Note:

- Add essential oils on the aroma pad only. Do not add into the water tank or any other places.
- The scent may be soft, this humidifier is not intended to work as an aroma diffuser.
- The scent level cannot be adjusted.
- If the aroma pad becomes too stiff, it needs to be replaced.

CLEANING AND MAINTENANCE

- Always turn off and UNPLUG the humidifier before any cleaning or maintenance.
- Do not clean the main body under running water.
- Do not let water splash into the air outlets.
- Do not use any chemical agents when cleaning the humidifier.
- Store in a cool, dry place and cover it to protect from dust.
- Do not overfilling the humidifier due to the potential risk of electric shock.

Filling & Refilling

1. Detach the water tank from the base.

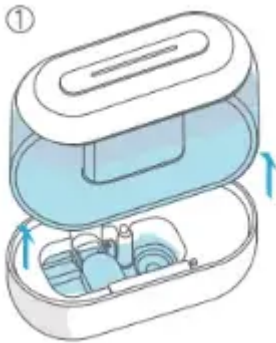

2. Take out the water tank cover, drain any remaining water from the tank and the base.

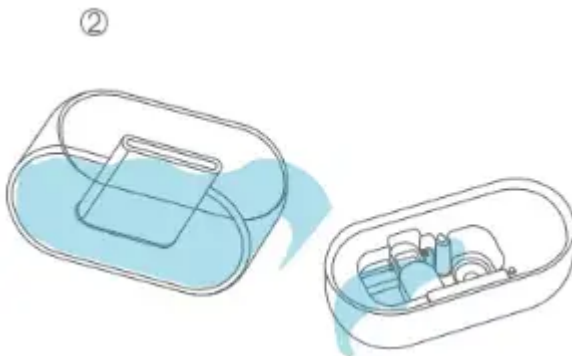

3. Rinse the tank with warm water.



4. Gently clean the base with a soft cloth or the included cleaning brush.

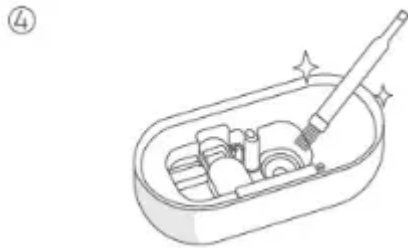

5. Wipe the tank clean with a soft, damp cloth.



6. Fill the tank with room temperature water. Do not fill with hot water.

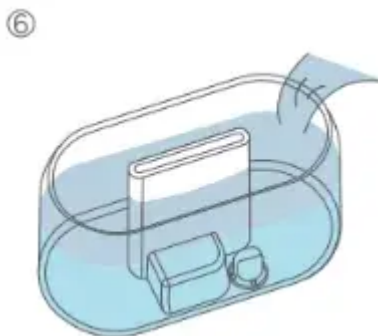

7. Attach the water tank to the base, replace the top cover.

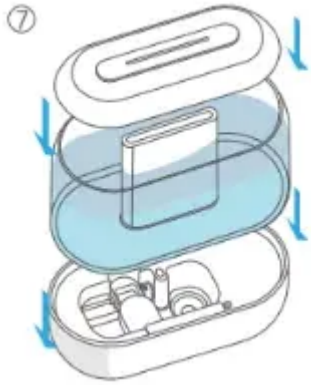

Descaling

1. Detach the water tank from the base. Take out the water tank cover and rinse it with warm water.

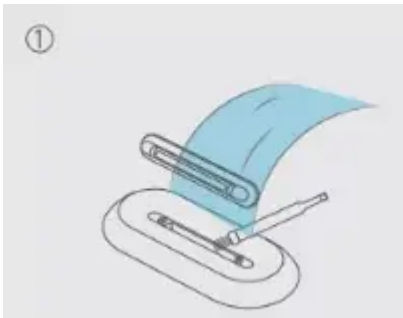

For a throughout cleaning, you may detach the nozzle from the cover and clean it with the included brush.

2. Drain any remaining water from the tank and the base.

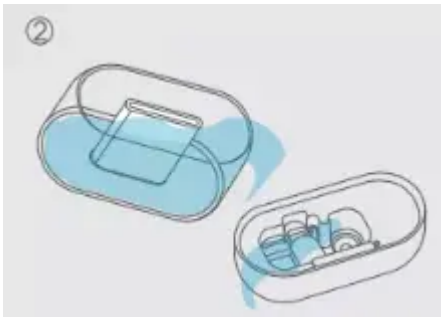

3. Fill the tank with a solution of bleach and water (one teaspoon of bleach for each gallon of water). Replace the tank cover and shake around the tank.

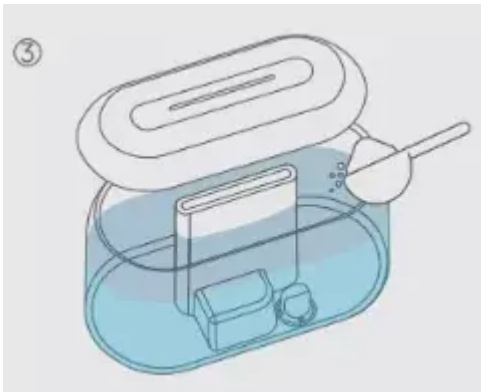

4. Attach the water tank to the base. Let it sit for 15-20 minutes.

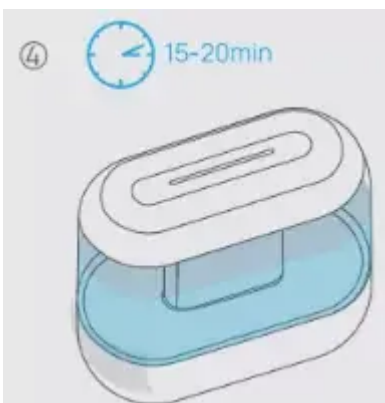

5. Remove the water silencer, water filter, droplet collector, and float.

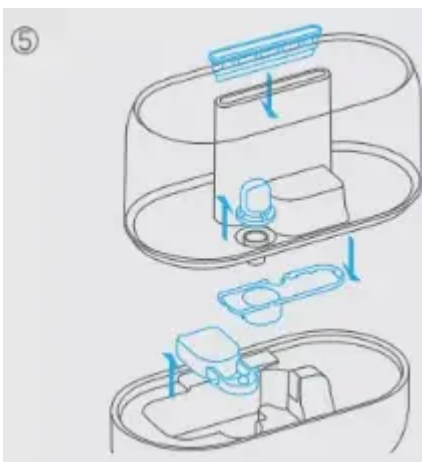

6. Place the float, water filter and silencer in a small container, fill with a solution of 50% vinegar and 50% water. Soak for 15-20 minutes.

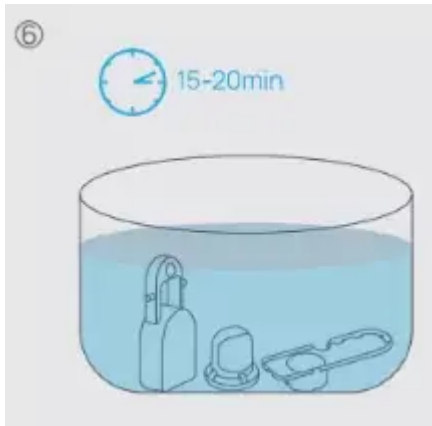

7. Remove the tank and detach the cover, drain any remaining solution from the tank and the base. Rinse the tank with water until the bleach smell is gone.

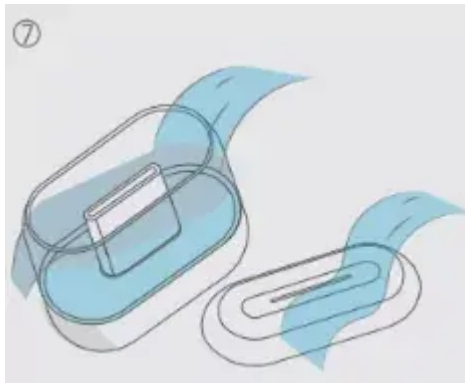

8. Clean the base with a soft cloth, you may use the included cleaning brush to remove excess of mineral deposit. Make sure all parts are dry before reassembling your humidifier.



Cleaning the aroma pad tray

RECOMMENDED ONCE A WEEK

1. Push to open the aroma pad tray at the back of the base to pull it out.

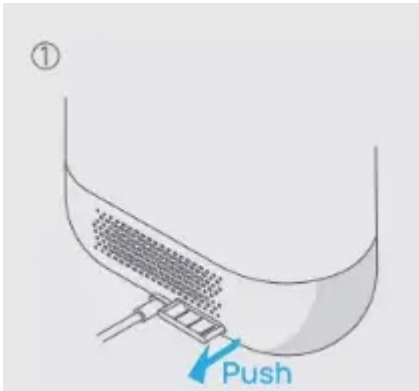

2. Rinse with water and place back into the base.

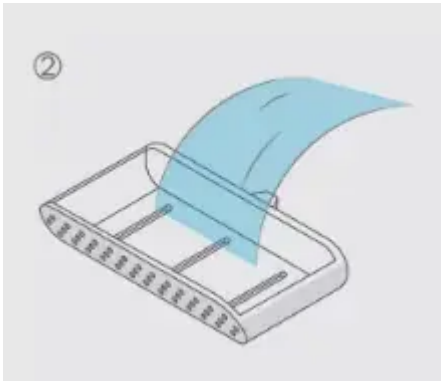

TROUBLESHOOTING

My humidifier does not work.

1. Make sure that the cord is connected to a powered outlet and the mains voltage corresponds with the voltage indicated on the humidifier.
2. The humidifier will shut down automatically in the event of low water.
3. Check the water tank is installed properly.

My humidifier is not misting.

1. Please check whether the air inlet is blocked.
2. Turn the mist level to a higher setting.
3. If the water tank or base was washed with detergent, rinse thoroughly with clean water to remove any remaining detergent.

There is white dust in the water tank.

You should descale the humidifier regularly. Using purified or distilled water can help prevent the formation of scale.

The mist produces an unpleasant smell.

1. Use purified or distilled water only. It is not recommended to use tap water.
2. Change water regularly to avoid dirty water accumulation.
3. Clean the humidifier and keep it dry for 12 hours with the cover detached.

If your problem is not listed or still persists, contact our Customer Support (see page 14).

DREO CUSTOMER CARE

Default 12-Month Warranty

This appliance covered by Dreo warranty for 12 months from the date of its original purchase.

Extend Your Warranty

Extend your warranty by registering your new appliance on our website: <https://dreo.com/warranty>

The warranty will not apply in cases of:

- Accident, misuse, or repairs performed by unauthorized personnel.
- Any unit that has been tampered with or used for commercial purposes.
- Normal wear and tear of wearable parts.
- Use of force, damage caused by external influences.
- Damage caused by non-observance of the User Manual, e.g., connection to an unsuitable mains supply or noncompliance with the instructions.
- Partially or completely dismantled appliances.
- Defects caused by or resulting from damages from shipping or from repairs, service, or alteration to the product or any of its parts that have been performed by a repair person not authorized by DREO.

We can only provide after-sales service for products that are sold by DREO or DREO authorized retailers and distributors. If you have purchased your unit from a different place, please contact your seller for return and warranty issues.

Warning

This content is compiled from multiple sources and is provided for reference purposes only. It may not be complete or fully applicable to all situations. If you are unable to resolve your issue, please contact the product manufacturer or an authorized service provider for official support.

Document generated by [ManualsFile](#)

