

REFRIGERATOR USE

Ensuring Proper Air Circulation

In order to ensure proper temperatures, you need to permit air to flow between the two sections. Cold air enters the bottom of the freezer section and moves up. It then enters the refrigerator section through the top vent. Air then returns to the freezer as shown.

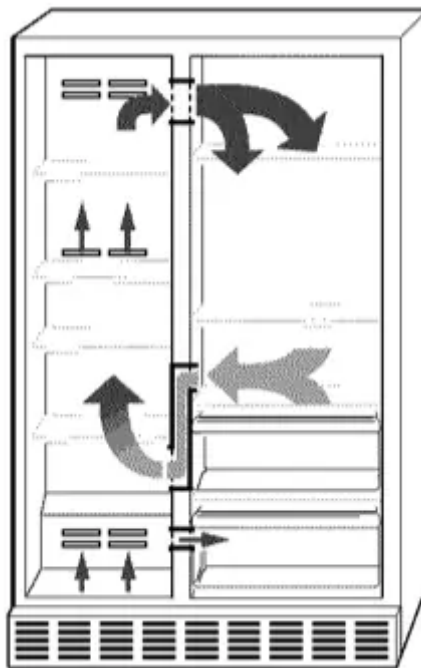

Do not block any of these vents with food such as soda, cereal, bread, etc. If the vents are blocked, airflow will be prevented and the temperature controls will not function properly.

IMPORTANT: Because air circulates between both sections, any odors formed in one section will transfer to the other. You must thoroughly clean both sections to eliminate odors. To prevent odor transfer from food, wrap or cover foods tightly.

Using the Controls

Your model may have Slide Controls, Electronic Controls or Digital Controls.

IMPORTANT (All Controls):

- The Refrigerator control adjusts the refrigerator compartment temperature. The Freezer control adjusts the freezer compartment temperature.
- Wait 24 hours after you turn on the refrigerator before you put food into it. If you add food before the refrigerator has cooled completely, your food may spoil.

NOTE: Adjusting the Refrigerator and Freezer controls to a lower (colder) setting will not cool the compartments any faster.

- If the temperature is too warm or too cold in the refrigerator freezer, first check the air vents to be sure they are not blocked before adjusting the controls.

or

- The preset settings should be correct for normal household usage. The controls are set correctly when milk or juice is as cold as you like and when ice cream is firm.

Slide Controls (on some models)

For your convenience, your controls are preset at the factory. When installing your refrigerator, make sure that the controls still preset to the "mid-settings" as shown.

Style 1

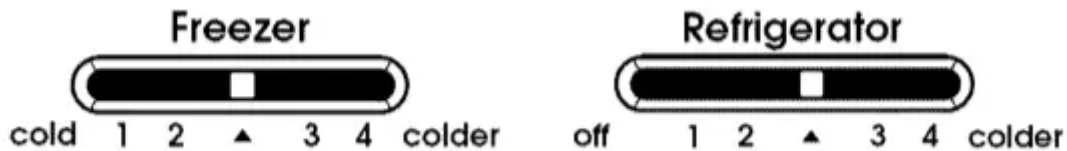

Style 2



IMPORTANT:

- For Style 1, your product will not cool when the Refrigerator control is set to OFE For Style 2, your product will not cool when the Freezer Control is set to OFE
- Settings to the left of the mid-setting make the temperature less cold. Settings to the right of the mid-setting make the temperature colder.
- The Automatic Exterior Moisture control continuously guards against moisture buildup on the outside of your refrigerator cabinet. This control does not have to be set or adjusted.

Adjusting Slide Controls

NOTE: Wait at least 24 hours between adjustments.

Recheck the temperatures before other adjustments are made.

If you need to adjust temperatures:

- Slide the FREEZER or REFRIGERATOR control, one setting to the right or left depending on the needed temperature change.

NOTE: For Style 1, after adjusting the refrigerator temperature, wait 24 hours and then recheck the FREEZER temperature before making additional adjustments.

| CONDITION: | SETTING ADJUSTMENT: |
|--|--|
| REFRIGERATOR too cold Not set correctly for conditions | REFRIGERATOR Control one setting lower |
| REFRIGERATOR too warm High use or room very warm | REFRIGERATOR Control one setting higher |
| FREEZER too cold Not set correctly for conditions | FREEZER Control one setting lower |
| FREEZER too warm/too little ice High use or heavy ice usage | FREEZER Control one setting higher |

Electronic Controls (on some models)

For your convenience, your controls are preset at the factory. When installing your refrigerator, make sure that the controls still preset to the "mid-settings" as shown.

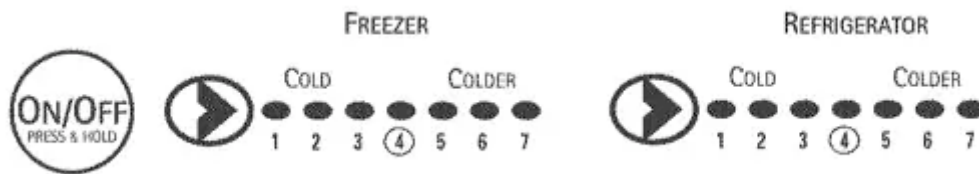

To turn on refrigerator:

- Press and hold ON/OFF for 2 seconds. The indicator lights show the current temperature control settings.

NOTE: Settings to the left of the mid-setting make the temperature less cold. Settings to the right of the mid-setting make the temperature colder.

Adjusting Electronic Controls

NOTE: Wait at least 24 hours between adjustments. Recheck the temperatures before other adjustments are made.

If you need to adjust temperatures:

- Press the FREEZER or REFRIGERATOR arrow to move the indicator light to the right, one setting at a time. Continue moving the indicator light until it is at the desired setting.



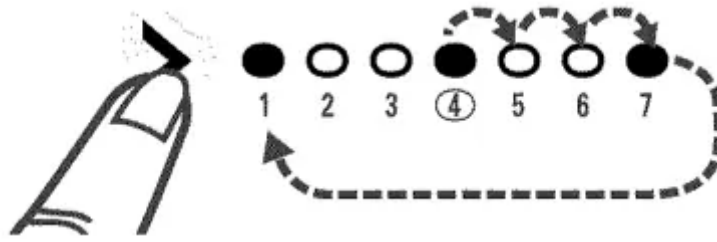

NOTE: With each press of the arrow, you will hear a beep as the light moves to the next setting. The indicator light moves to a setting of "7" and then returns to the setting of "1."

| CONDITION: | SETTING ADJUSTMENT: |
|--|--|
| REFRIGERATOR too cold Not set correctly for conditions | REFRIGERATOR Control one setting lower |
| REFRIGERATOR too warm High use or room very warm | REFRIGERATOR Control one setting higher |
| FREEZER too cold Not set correctly for conditions | FREEZER Control one setting lower |
| FREEZER too warm/too little ice High use or heavy ice usage | FREEZER Control one setting higher |

Additional Electronic Control Panel Features

Additional features are located on the control panel at the top of the refrigerator compartment.

Water Filter Indicator Light and Reset

See "Water Filter Status Light."

Accelerated Ice Production

This feature assists with temporary periods of heavy ice usage by increasing ice production over a 24-hour period.

- Press ICE touch pad to set the freezer temperature to -10°F (-23°C). The Accelerated Ice setting will remain on for 24 hours unless manually turned off. The display will continue to show your normal temperature set point.



- If increased ice production is desired at all times, set the Freezer Control to a colder setting. Adjusting the freezer to a colder temperature may make some foods, such as ice cream, harder.

Digital Controls (on some models)

For your convenience, your controls are preset at the factory. When installing your refrigerator, make sure that the controls still preset to the "mid-settings" as shown. The digital control panel is located at the top of the refrigerator compartment.

NOTE: The factory recommended set points are 0°F (-18°C) for the freezer and 37°F (3°C) for the refrigerator.

To turn refrigerator on and view set points:

- Press and hold POWER (ON/OFF) pad for 2 seconds.



To view the Celsius temperatures:

- Press the °C SELECT pad. The indicator will light up. To redisplay degrees in Fahrenheit, press the °C SELECT pad again.



NOTE: If the freezer temperature is below zero, the negative sign next to the freezer display will light up.

Adjusting Digital Controls

NOTE: Wait at least 24 hours between adjustments. Recheck the temperatures before other adjustments are made.

To adjust set point temperatures:

- Press the refrigerator or freezer PLUS (+) or MINUS (-) pad until the desired temperature is reached.



The set point range for the freezer is -5°F to 5°F (-21 °C to -15°C). The set point range for the refrigerator is 33°F to 41°F (1°C to 5°C).

| CONDITION/REASON: | TEMPERATURE ADJUSTMENT: |
|--|--------------------------------|
| REFRIGERATOR too cold Not set correctly for conditions | REFRIGERATOR Control 1° higher |
| REFRIGERATOR too warm High use or room very warm | REFRIGERATOR Control 1° lower |
| FREEZER too cold Not set correctly for conditions | FREEZER Control 1° higher |
| FREEZER too warm/too little ice High use or heavy ice use | FREEZER Control 1° lower |

Additional Digital Control Panel Features

Additional features are located on the control panel at the top of the refrigerator compartment.

Water Filter Indicator Light and Reset

See "Water Filter Status Light."

Max Cool

The Max Cool feature assists with periods of heavy ice usage, full grocery loads, or temporarily warm room temperatures.

- Press MAX COOL pad to turn on the Max Cool feature. The Max Cool indicator light will remain on for 24 hours unless manually turned off.



NOTE: The temperature display will not change. After 24 hours, the refrigerator returns to the previous temperature set points.

Accelerated Ice Production (on some models)

This feature assists with temporary periods of heavy ice use by increasing ice production over a 24-hour period.

- Press OPTIMICE touch pad to turn on the OptimIce ®feature. The OptimIce ®setting will remain on for 24 hours unless manually turned off.



- If increased ice production is desired at all times, set the Freezer Control to a colder number. Setting the freezer to a colder temperature may make some foods, such as ice cream, harder.

Temperature System

The Temperature System feature lets you know the compressor or evaporator fan is running. It is normal for this indicator light to be on.

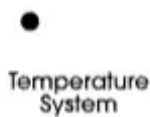

Water and Ice Dispensers

WARNING Cut Hazard Use a sturdy gBase when dispensing ice or water. Failure to do so can result in cuts.

Depending on your model, you may have one or more of the following options: the ability to select either crushed or cubed ice, a special light that turns on when you use the dispenser, a special AUTO mode, or a lock option to avoid unintentional dispensing.

The Ice Dispenser

Ice dispenses from the ice maker storage bin in the freezer. When the dispenser lever is pressed:

- A trap door opens in a chute between the dispenser and the ice bin. Ice moves from the bin and falls through the chute.
- When you release the dispenser lever, the trap door closes and the ice dispensing stops. The dispensing system will not operate when the freezer door is open.

Some models dispense both cubed and crushed ice. Before dispensing ice, select which type of ice you prefer. The button controls are designed for easy use and cleaning.

Style 1

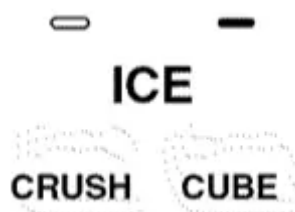

Style 2

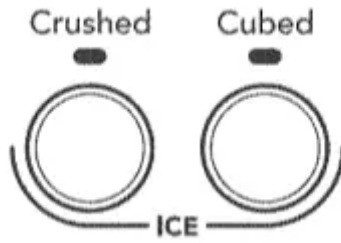

For crushed ice, cubes are crushed before they are dispensed. This may cause a slight delay when dispensing crushed ice. Noise from the ice crusher is normal, and pieces of ice may vary in size. When changing from crushed to cubed, a few ounces of crushed ice will be dispensed along with the first cubes.

To Dispense Ice:

1. Press button for the desired type of ice.
2. Press a sturdy glass against the ice dispenser lever. Hold the glass close to the dispenser opening so ice does not fall outside of the glass.

IMPORTANT: You do not need to apply a lot of pressure to the lever in order to activate the ice dispenser. Pressing hard will not make the ice dispense faster or in greater quantities.

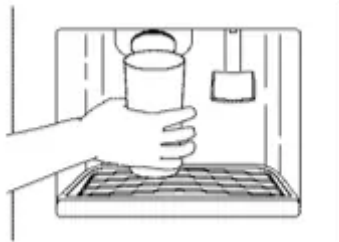

3. Remove the glass to stop dispensing. **NOTE:** The first few batches of ice may have an off-flavor from new plumbing and parts. Throw the ice away. Also, take large amounts of ice from the ice bin, not through the dispenser.

The Water Dispenser

If you did not flush the water system when the refrigerator was first installed, press the water dispenser bar with a sturdy glass or jar until you draw and discard 2 to 3 gal. (8 to 12 L) or approximately 6 to 7 minutes of water after water begins dispensing. It will take 3 to 4 minutes for the water to begin dispensing. The water you draw and discard cleans the system and helps clear air from the lines. Allow several hours for the refrigerator to cool down and chill water.

IMPORTANT: Depending on your model, the small removable tray at the bottom of the dispenser is designed to catch small spills and allow for easy cleaning. There is no drain in the tray. The tray can be removed from the dispenser and carried to the sink to be emptied or cleaned.

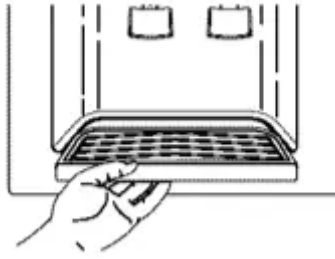

To Dispense Water:

1. Press a sturdy glass against the water dispenser lever.
2. Remove the glass to stop dispensing.

NOTE: Water may have an off-flavor if you do not use the dispenser periodically. Dispense enough water every week to maintain a fresh supply.

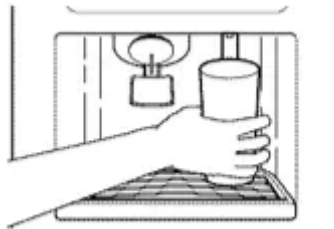

The Dispenser Light

Style 1

The dispenser area has a light. It can be turned on manually by pressing the ON button (touch pad or rocker switch). On some models: Whenever you use the dispenser the lever will automatically turn the light on.



NOTE: See "Changing the Light Bulbs" for information on changing the dispenser light bulb.

Style 2

When you use the dispenser, the lever will automatically turn the light on. If you want the light to be on continuously, you may choose either ON or AUTO.



ON: Press the LIGHT button to turn the dispenser light on.

AUTO: Press the LIGHT button a second time to select the AUTO mode. The dispenser light will automatically adjust to become brighter as the room brightens, dimmer as the room darkens.

OFF: Press the LIGHT button a third time to turn the dispenser light off.

The dispenser lights are LEDs which should not need to be changed. If it appears that your dispenser lights are not working, check to be sure that the light sensor is not blocked (in AUTO mode). See "Troubleshooting" for more information.



The Dispenser Lock (on some models)

Your dispenser can be turned off for easy cleaning or to prevent unintentional dispensing by small children and pets.

NOTE: The lock feature does not shut off power to the refrigerator, to the ice maker, or to the dispenser light. It simply deactivates the dispenser levers.

Style 1

To turn off the dispenser, press the LOCK button until the indicator appears. The ice and water dispensers will not work. To unlock the dispenser, press the UNLOCK button until the indicator appears. Then continue to dispense ice or water as usual.

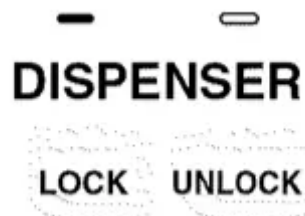

Style 2

To turn off the dispenser, press and hold the LOCK OUT button until the indicator appears. The ice and water dispensers will not work. To unlock the dispenser, press the LOCK OUT button until the indicator disappears. Then continue to dispense ice or water as usual.

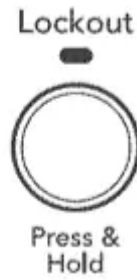

Water Filter Status Light

The water filter status light will help you know when to change your water filter cartridge. The light will change from green to yellow. This tells you that it is almost time to change the water filter cartridge (90% of the filter life has been used). It is recommended that you replace the base grille water filter cartridge when the water filter indicator light changes to red OR water flow to your water dispenser or ice maker decreases noticeably. To change the base grille water filter cartridge, see "Changing the Water Filter Cartridge" later in this section.

After changing the water filter cartridge, reset the water filter status light.

Style 1

Press the light switch 5 times within 10 seconds. The status light will change from red to green.

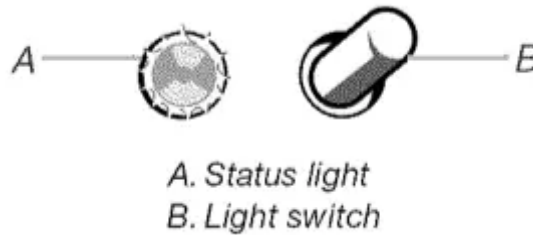

Style 2

Press and hold the water filter reset button until the status light turns green. Your reset button may be located on the water dispenser or on the control panel in the refrigerator compartment.

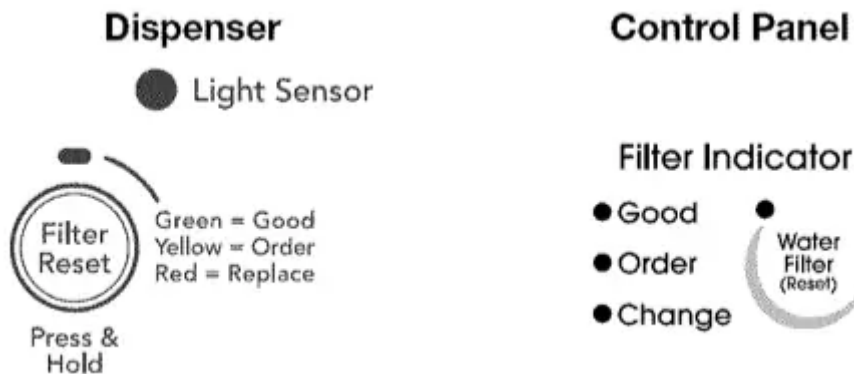

Water Filtration System

NOTE: Do not use with water that is microbiologically unsafe or of unknown quality without adequate disinfection before or after the system.

Changing the Water Filter Cartridge

1. Locate the water filter cartridge cap in the front base grille. Rotate the cap counterclockwise to a vertical position and pull the cap and filter cartridge out through the base grille.

NOTE: There will be water in the cartridge. Some spilling may occur.

2. Remove the cartridge cap by sliding it off the end of the old cartridge. The cap will slide to the left or right. Do not discard the cap.

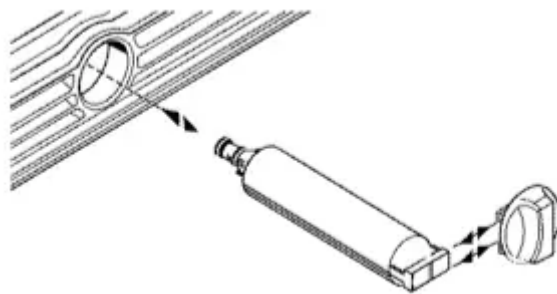

3. Take the new cartridge out of its packaging and remove protective cover from O-rings.



4. Slide the cartridge cap onto the new cartridge. See illustration in Step 2.
5. With cartridge cap in the vertical position, push the new filter cartridge into the base grille until it stops. Rotate the cartridge cap clockwise to a horizontal position. Flush the water system. See "Flushing the Water System After Replacing Filter" section.

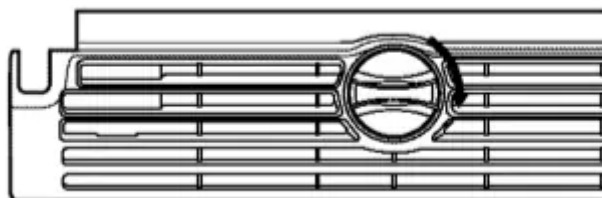

Flushing the Water System After Replacing Filter

Use a sturdy container to depress the water dispenser bar until the water begins to flow. Flush the water system by dispensing and discarding 2 to 3 gal. (8 to 12 L) of water. Cleaning the system will

take approximately 6 to 7 minutes and will help clear air from the line. Additional flushing may be required in some households.

NOTE: As air is cleared from the system, water may spurt out of the dispenser.

Using the Dispenser Without the Water Filter Cartridge

You can run the dispenser without a water filter cartridge. Your water will not be filtered.

1. Remove the base grille water filter cartridge.
2. Slide the cartridge cap off the end of the filter cartridge. Do not discard the cap. With the cartridge cap in the vertical position, insert the cap into the base grille until it stops.

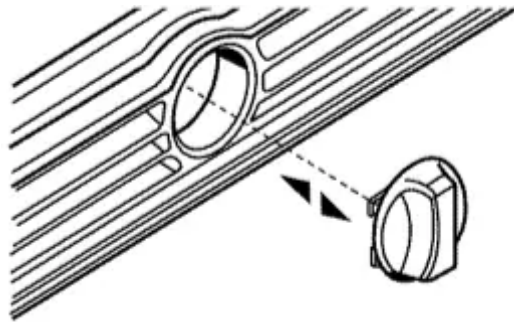

3. Rotate the cartridge cap to a horizontal position. The cartridge cap might not be even with the base grille.

Ice Maker and Storage Bin

Style 1

The on/off switch for the ice maker is a wire shutoff arm located on the side of the ice maker.

1. To turn the ice maker on, simply lower the wire shutoff arm.

NOTE: Your ice maker has an automatic shutoff. As ice is made, the ice cubes will fill the ice storage bin and the ice cubes will raise the wire shutoff arm to the OFF (arm up) position.

2. To manually turn the ice maker off, lift the wire shutoff arm to the OFF (arm up) position and listen for the click to make sure the ice maker will not continue to operate.

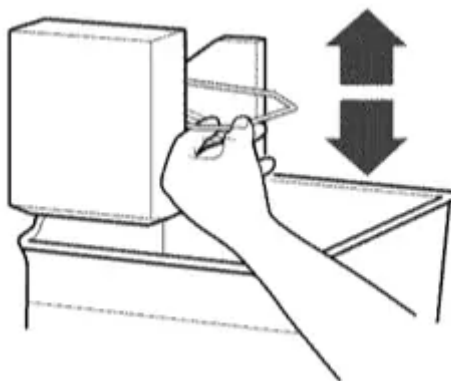

To Remove and Replace Ice Storage Bin:

1. Pull the covering panel out from the bottom and then slide it back toward the rear.
2. Lift the wire shutoff arm so it clicks into the OFF (up) position. Ice can still be dispensed, but no more can be made.
3. Lift up the front of the storage bin and pull it out.

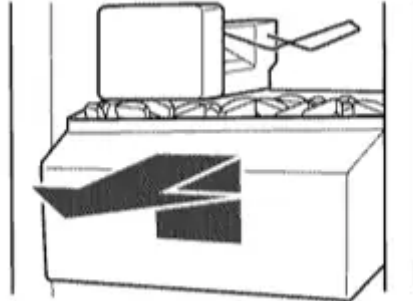

4. Replace the bin by pushing it in all the way or the dispenser will not work. Push the wire shutoff arm down to the ON position to restart ice production. Make sure the door is closed tightly.

Style 2

To Turn the Ice Maker On/Off:

The ON/OFF switch is located on the top right side of the freezer compartment.

1. To turn the ice maker on, slide the control to the ON (left) position. **NOTE:** Your ice maker has an automatic shutoff. The ice maker sensors will automatically stop ice production, but the control will remain in the ON (left) position.
2. To manually turn the ice maker off, slide the control to the OFF (right) position.

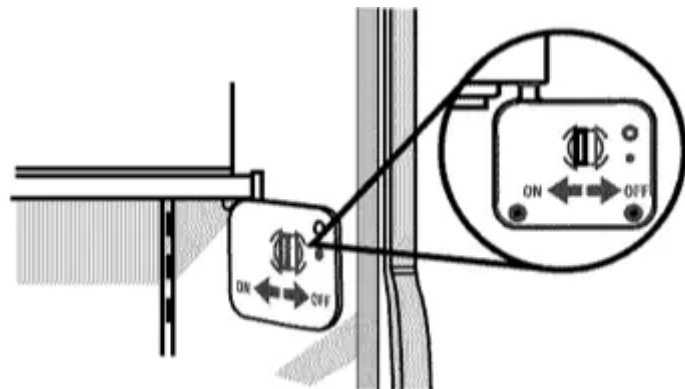

To Remove and Replace the Ice Storage Bin:

1. Hold the base of the storage bin with both hands and press the release button to lift the storage bin up and out. **NOTE:** It is not necessary to turn the ice maker control to the OFF (right) position when removing the storage bin. The sensor cover ("flipper door") on the left wall of the freezer stops the ice maker from producing ice if the door is open or the storage bin is removed.

2. Replace the storage bin on the door and push down to make sure it is securely in place.



Clean the Ice Storage Bin

1. Empty the ice container. Use warm water to melt the ice if necessary.

NOTE: Never use anything sharp to break up the ice in the bin. This can cause damage to the ice container and the dispenser mechanism.

2. Wash ice bin with a mild detergent, rinse well and dry thoroughly. Do not use harsh or abrasive cleaners or solvents.

Remember

- Allow 24 hours to produce the first batch of ice. Allow 3 days to completely fill ice container.
- Discard the first three batches of ice produced to avoid impurities that may be flushed out of the system.
- The quality of your ice will be only as good as the quality of the water supplied to your ice maker. Avoid connecting the ice maker to a softened water supply. Water softener chemicals (such as salt) can damage parts of the ice maker and lead to poor quality ice. If a softened water supply cannot be avoided, make sure the water softener is operating properly and is well maintained.
- It is normal for the ice cubes to be attached at the corners. They will break apart easily.
- For Style I ice maker, do not force the wire shutoff arm up or down.
- Do not store anything on top of the ice maker or in the ice storage bin.

REFRIGERATOR FEATURES

Your model may have some or all of these features. Features that can be purchased separately as product accessories are labeled with the word "Accessory." Not all accessories will fit all models. If you are interested in purchasing one of the accessories, please call the toll-free number on the cover or in the "Accessories" section.

Important information to know about glass shelves and covers:

Do not clean glass shelves or covers with warm water when they are cold. Shelves and covers may break if exposed to sudden temperature changes or impact, such as bumping. For your

protection, tempered glass is designed to shatter into many small, pebble-size pieces. This is normal. Glass shelves and covers are heavy. Use special care when removing them to avoid impact from dropping.

Refrigerator Shelves

Your model may have glass or wire shelves. Store similar foods together and adjust the shelves to fit different heights. This reduces the time the refrigerator door is open and saves energy.

Slide-out Shelves (on some models)

To Remove and Replace a Shelf in a Metal Frame:

1. Pull the shelf forward to the stop. Tilt the front of the shelf up and lift it slightly as you pull the shelf from the frame.
2. Replace the shelf by guiding it back into the slots on the frame and pushing the shelf in past the stop.

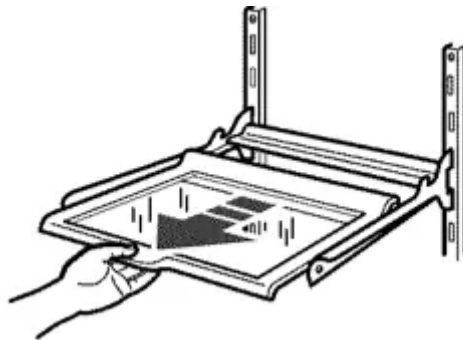

Shelves and Shelf Frames

To Remove and Replace a Shelf/Frame:

1. Remove the shelf/frame by tilting it up at the front and lifting it out of the shelf supports.
2. Replace the shelf/frame by guiding the rear shelf hooks into the shelf supports. Tilt the front of the shelf up until rear shelf hooks drop into the shelf supports. Check to make sure that the shelf is securely in position.

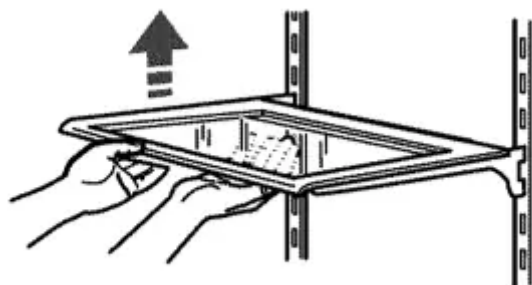

Deli Drawer

The deli drawer stores raisins, nuts, spreads, and other small items at normal refrigerator temperatures.

To Remove and Replace the Deli Drawer:

1. Remove the deli drawer by sliding it straight out to the stop. Lift the front and slide the drawer out the rest of the way.
2. Replace the deli drawer by sliding it back past the stop.

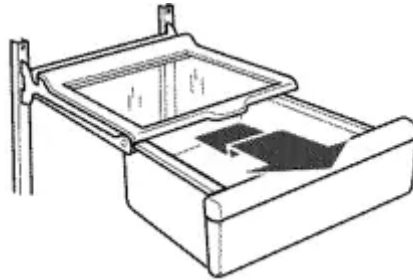

Convertible Vegetable/Meat Drawer, Crisper and Covers

Crisper and Convertible Vegetable Meat Drawers

To Remove and Replace Drawers:

1. Slide crisper or meat drawer straight out to the stop. Lift the front of drawer with one hand while supporting the bottom of drawer with other hand and slide the drawer out the rest of the way.
2. Replace the crisper or meat drawer by sliding it back in fully past the drawer stop.

Crisper or Vegetable/Meat Drawer Covers

To Remove and Replace Covers:

1. Remove the crisper and meat drawer. Press up in center of crisper glass insert until it rises above the plastic frame. Holding the crisper glass firmly, carefully slide the glass insert forward to remove.
2. Lift crisper cover frame and remove. Repeat steps to remove the meat drawer cover.

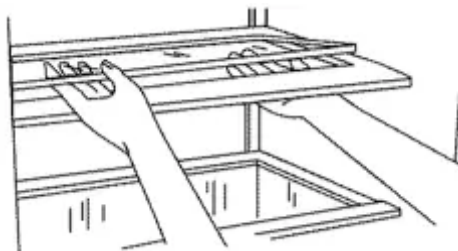

Replace back of meat drawer cover frame into supports or slides on side walls of the refrigerator and lower or slide the front of the cover frame into place.

Slide rear of glass insert into cover frame and lower front into place. Repeat steps to replace the crisper cover.

Convertible Vegetable/Meat Drawer Temperature Control

The convertible vegetable/meat drawer can be adjusted to properly chill meats or vegetables. The air inside the pan is cooled to prevent “spot” freezing and can be set to keep meats at the National Livestock and Meat Board recommended storage temperatures of 28° to 32°F (-2° to 0°C).

IMPORTANT: To extend freshness, wrap meats in airtight, moisture-proof materials before storing. Always store meat as recommended.

Adjusting the Control

The convertible control comes preset at the lowest meat setting. **To change a control setting:** Move the control to the right (colder) or to the left (less cold) as desired.

To store vegetables: Set the control to VEG (all the way to the left) to store vegetables at their optimal storage temperatures (which need to be warmer than those for meat).

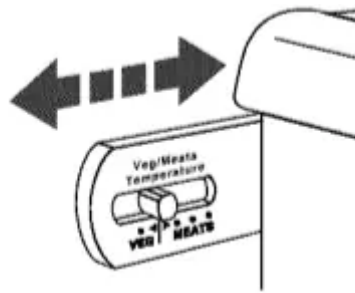

IMPORTANT: If food starts to freeze, move the control to the left (less cold). Remember to wait 24 hours between adjustments. Doing so gives the temperature of the food time to change.

Meat Storage Guide

Store most meat in original wrapping as long as it is airtight and moisture-proof. Rewrap if necessary. See the following chart for storage times. When storing meat longer than the times given, freeze the meat.

Fresh fish or shellfish.....use same day as purchased

Chicken, ground beef, variety meat (liver, etc.).....1-2 days

Cold cuts, steaks/roasts.....3-5 days

Cured meats.....7-10 days

Leftovers - Cover leftovers with plastic wrap, aluminum foil, or plastic containers with tight lids.

Crisper Humidity Control

The Crisper Humidity control is located on the crisper cover. You can control the amount of humidity in the moisture-sealed crisper. Adjust the control to any setting between LOW and HIGH.

LOW (open) lets moist air out of the crisper for best storage of fruits and vegetables with skins.

- Fruit: Wash, let dry and store in refrigerator in plastic bag or crisper. Do not wash or hull berries until they are ready to use. Sort and keep berries in original container in crisper, or store in a loosely closed paper bag on a refrigerator shelf.
- Vegetables with skins: Place in plastic bag or plastic container and store in crisper.

HIGH (closed) keeps moist air in the crisper for best storage of fresh, leafy vegetables.

- Leafy vegetables: Wash in cold water, drain and trim or tear off bruised and discolored areas. Place in plastic bag or plastic container and store in crisper.

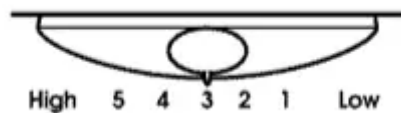

Wine Rack

To Remove and Replace the Wine Rack:

1. Remove the rack by pulling it straight out from the shelf.
2. Replace the rack by sliding it in between the shelf and the wall of the refrigerator.

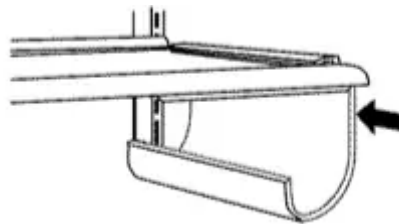

Utility Bin

NOTE: For long-term storage, place eggs in a covered container or in their original carton on an interior shelf.

FREEZER FEATURES

Your model may have some or all of these features. Features that can be purchased separately as product accessories are labeled with the word “Accessory.” Not all accessories will fit all models. If you are interested in purchasing one of the accessories, please call the toll-free number on the cover or in the “Accessories” section.

Freezer Shelf

To Remove and Replace the Shelf:

1. Lift the shelf off of the supports.

2. Slide it out of the shelf support holes.
3. Replace shelf in the reverse order.



Frozen Food Storage Guide

Storage times will vary according to the quality and type of food, the type of packaging or wrap used (should be airtight and moisture-proof), and the storage temperature. Ice crystals inside a sealed package are normal. This simply means that moisture in the food and air inside the package have condensed, creating ice crystals.

Put no more unfrozen food into the freezer than will freeze within 24 hours (no more than 2 to 3 lbs. of food per cubic foot [907 to 1,360 g per 28 L] of freezer space). Leave enough space in the freezer for air to circulate around packages. Be careful to leave enough room for the door to close tightly.

For more information on preparing food for freezing, check a freezer guide or reliable cookbook.

Freezer Basket or Bin

The freezer basket or bin can be used to store bags of frozen fruits and vegetables that may slide off freezer shelves.

To Remove and Replace the Freezer Basket or Bin:

1. Remove basket or bin by sliding it out to the stop.
2. Lift the front of the basket or bin and slide it out the rest of the way.

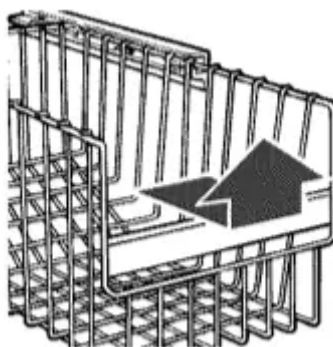

3. Replace the basket or bin by positioning it on the side wall guide rails. Lift the basket or bin front slightly while pushing it past the guide rail stops and slide basket or bin in the rest of the way.

DOOR FEATURES

Your model may have some or all of these features. Features that can be purchased separately as product accessories are labeled with the word “Accessory.” Not all accessories will fit all models. If you are interested in purchasing one of the accessories, please call the toll-free number on the cover or in the “Accessories” section.

Tilt-out Freezer Door Bin

To Remove and Replace the Bin:

1. Remove the bin by pulling out on the tabs behind the basket to release it from the door liner.
2. Replace the bin by aligning the tabs with the buttons on the sides of the door liner. Firmly snap the tabs onto the buttons as shown.

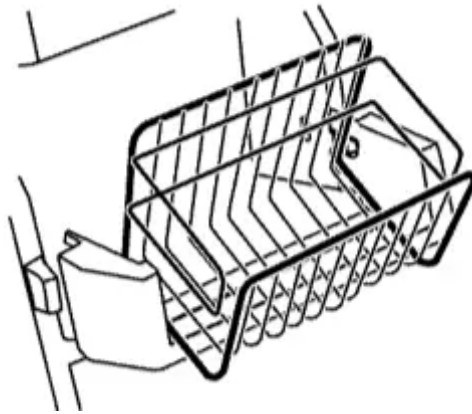

Snap-on Freezer Door Bin

The door bin may be removed for easier cleaning.

To Remove and Replace the Bin:

1. Remove the door bin by pushing in slightly on the front of the bracket while pulling out on the inside tab. Repeat these steps for the other end of the door bin.
2. Replace the door bin by aligning the ends of the brackets with the buttons on the sides of the door liner. Firmly snap bracket and rail assembly onto the tabs above the shelf as shown.

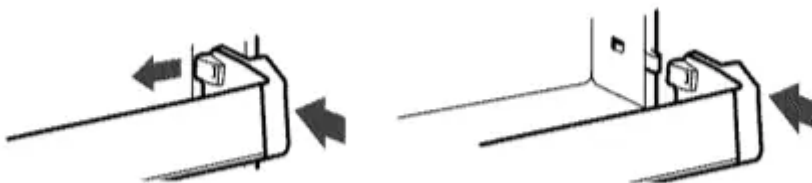

Drop-in Door Rails

To Remove and Replace the Rails:

1. Remove the rails by pulling straight up on each end of the rail.
2. Replace the rails by sliding the shelf rail into the slots on the door and pushing the rail straight down until it stops.

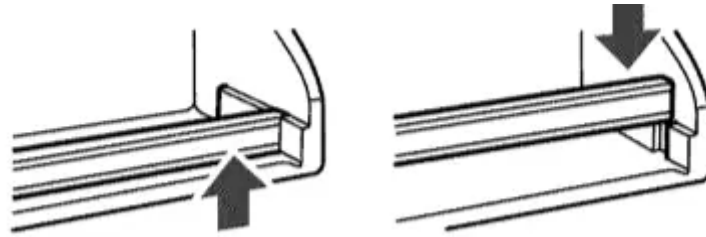

Can Racks and Door Bins

NOTE: Can racks may be purchased as an Accessory for some models.

To Remove and Replace the Racks/Bins:

1. Remove the rack/bin by lifting it and pulling it straight out.
2. Replace the rack/bin by sliding it in above the desired support and pushing it down until it stops.

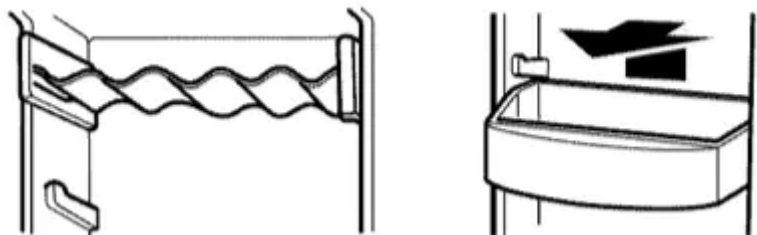

Door Air Control

The door air control is located on the left-hand side of the refrigerator compartment.

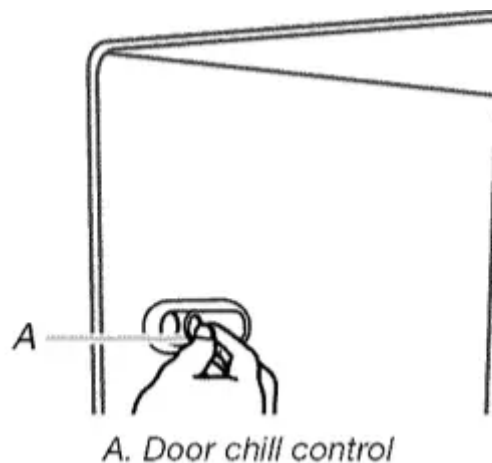

- Slide the door air control to the left to reduce the flow of cold air to the bin or can rack and make it less cold.

- Slide the door air control to the right to increase the flow of cold air to the bin or can rack and make it colder.

REFRIGERATOR CARE

Cleaning

WARNING Explosion Hazard Use nonflammable cleaner. Failure to do so can result in death, explosion, or fire.

Both the refrigerator and freezer sections defrost automatically.

However, clean both sections about once a month to prevent odors from building up. Wipe up spills immediately.

To Clean Your Refrigerator:

1. Unplug refrigerator or disconnect power.
2. Remove all removable parts from inside, such as shelves, crispers, etc.
3. Hand wash, rinse, and dry removable parts and interior surfaces thoroughly. Use a clean sponge or soft cloth and a mild detergent in warm water.
 - Do not use abrasive or harsh cleaners such as window sprays, scouring cleansers, flammable fluids, cleaning waxes, concentrated detergents, bleaches or cleansers containing petroleum products on plastic parts, interior and door liners or gaskets. Do not use paper towels, scouring pads, or other harsh cleaning tools. These can scratch or damage materials.
 - To help remove odors, you can wash interior walls with a mixture of warm water and baking soda (2 tbs. to 1 qt. [26 g to 0.95 L] of water).
4. Determine whether your refrigerator exterior is painted metal, brushed aluminum or stainless steel and choose the appropriate cleaning method.

Painted metal: Wash exteriors with a clean sponge or soft cloth and a mild detergent in warm water. Do not use abrasive or harsh cleaners, or cleaners designed for stainless steel. Dry thoroughly with a soft cloth. For additional protection against damage to painted metal exteriors, apply appliance wax (or auto paste wax) with a clean, soft cloth. Do not wax plastic parts.

Brushed aluminum: Wash with a clean sponge or soft cloth and a mild detergent in warm water. Do not use abrasive or harsh cleaners, or cleaners designed for stainless steel. Dry thoroughly with a soft cloth.

Stainless steel finish: Wash with a clean sponge or soft cloth and a mild detergent in warm water. Do not use abrasive or harsh cleaners. Dry thoroughly with a soft cloth.

- To keep your stainless steel refrigerator looking like new and to remove minor scuffs or marks, it is suggested that you use the manufacturer's approved Stainless Steel Cleaner & Polish.

IMPORTANT: This cleaner is for stainless steel parts only!

Do not allow the Stainless Steel Cleaner & Polish to come into contact with any plastic parts such as the trim pieces, dispenser covers or door gaskets. If accidental contact does occur, clean plastic part with a sponge and mild detergent in warm water. Dry thoroughly with a soft cloth. To order the cleaner, see the "Accessories" section.

5. There is no need for routine condenser cleaning in normal home operating environments. If the environment is particularly greasy or dusty, or there is significant pet traffic in the home, the condenser should be cleaned every 2 to 3 months to ensure maximum efficiency.

If you need to clean the condenser:

- Remove the base grille. See "Base Grille" graphic or "Base Grille" section.
- Use a vacuum cleaner with a soft brush to clean the grille, the open areas behind the grille and the front surface area of the condenser.
- Replace the base grille when finished.

6. Plug in refrigerator or reconnect power.

Changing the Light Bulbs

NOTE: Not all appliance bulbs will fit your refrigerator. Be sure to replace the bulb with one of the same size and shape. The dispenser light requires a heavy duty 10-watt bulb. All other lights require a 40-watt appliance bulb. Replacement bulbs are available from your dealer.

1. Unplug refrigerator or disconnect power.
2. Remove light shield when applicable as shown.

NOTE: To clean the light shield, wash it with warm water and liquid detergent. Rinse and dry the shield well.

3. Remove light bulb and replace with one of the same size, shape and wattage.
4. Replace light shield when applicable as shown.
5. Plug in refrigerator or reconnect power.

Dispenser Light (on some models)

Reach through the dispenser area to remove and replace light bulb.

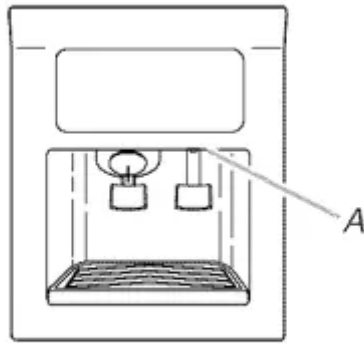

A. Dispenser light

Refrigerator Control Panel Light

Reach behind the refrigerator control panel to remove and replace light bulb.

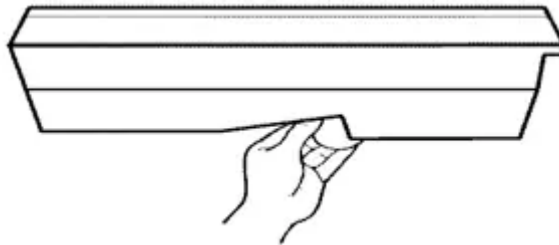

Crisper Lights

- If necessary, remove the top crisper drawer to access the crisper light shield. Remove the light shield by lifting the ends out of the brackets as shown.
- Replace the light shield by inserting the ends into the brackets. If necessary, replace the top crisper drawer.

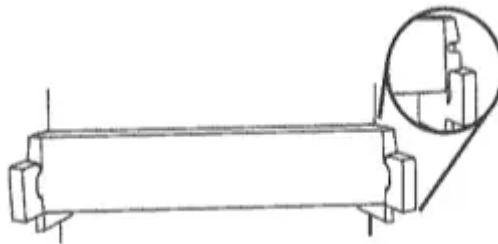

Upper Freezer Light (on some models)

Style 1

- Remove light shield by grasping the top center of the shield and pulling forward while turning it slightly to one side. If necessary, remove top crisper drawer to gain access to the crisper light shield.
- Replace the light shield by inserting the tabs on one end into the slotted holes in the refrigerator or freezer liner. Then, carefully bend the shield at the center to insert the tabs on the other end.

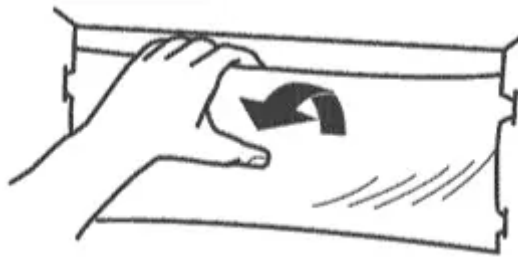

Style 2

- Remove the light shield by squeezing the sides of the light shield in toward the center while pulling the shield forward as shown.
- Replace the light shield by fitting the tabs into the slotted holes in the freezer liner. Push in the shield until it snaps into place.

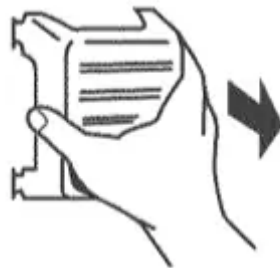

Lower Freezer Light (on some models)

Style 1 - Beneath Ice Bin

- Remove the light shield by grasping the sides and squeezing in toward the center. Once the side hooks of shield are free from the freezer lining, pull down the shield.
- Replace the light shield by squeezing the sides toward the center and inserting the side hooks into the slotted holes. Once the side hooks are in place, snap the front tab into the slotted hole.

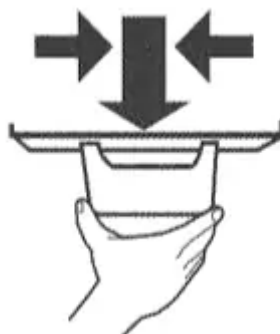

Style 2 - Behind Freezer Basket

- Depending on your model, remove the top freezer basket or top freezer basket shelf. Remove light shield by removing the Phillips screw on the top of the shield. Carefully rotate the shield until the left tab can be gently pulled from the freezer wall.

- Replace the light shield by inserting the left tab into the freezer wall. Align top tab with screw hole and replace screw.

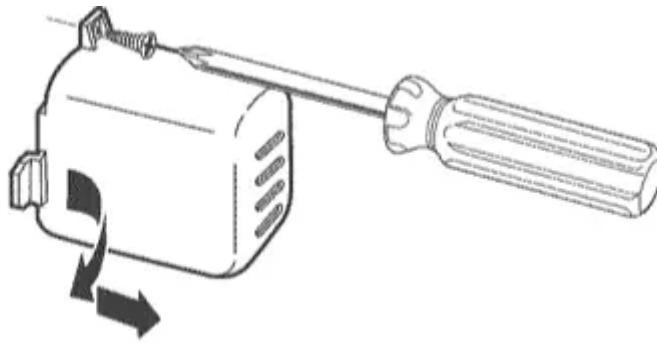

Power Interruptions

If the power will be out for 24 hours or less, keep the door or doors closed (depending on your model) to help food stay cold and frozen.

If the power will be out for more than 24 hours, do one of the following:

- Remove all frozen food and store it in a frozen food locker.
- Place 2 lbs. (907 g) of dry ice in the freezer for every cubic foot (28 L) of freezer space. This will keep the food frozen for 2 to 4 days.
- If neither a food locker nor dry ice is available, consume or can perishable food at once.

REMEMBER: A full freezer stays cold longer than a partially filled one. A freezer full of meat stays cold longer than a freezer full of baked goods. If you see that food contains ice crystals, it may be refrozen, although the quality and flavor may be affected. If the condition of the food is poor, dispose of it. * 1

Vacation and Moving Care

Vacations

If You Choose to Leave the Refrigerator On While You're Away:

1. Use up any perishables and freeze other items.
2. If your refrigerator has an automatic ice maker:
 - Raise wire shutoff arm to OFF (up) position or move the switch to the OFF (right) setting.
 - Shut off water supply to the ice maker.
3. Empty the ice bin.

If You Choose to Turn the Refrigerator Off Before You Leave:

1. Remove all food from the refrigerator.

2. If your refrigerator has an automatic ice maker:
 - Turn off the water supply to the ice maker at least one day ahead of time.
 - When the last load of ice drops, raise the wire shutoff arm to the OFF (up) position or move the switch to the OFF (right) setting.
3. Depending on the model, turn the Thermostat Control or Refrigerator Control to OFF. See “Using the Controls.”
4. Clean refrigerator, wipe it, and dry well.
5. Tape rubber or wood blocks to the tops of both doors to prop them open far enough for air to get in. This stops odor and mold from building up.

Moving

When you are moving your refrigerator to a new home, follow these steps to prepare it for the move.

1. If your refrigerator has an automatic ice maker:
 - Turn off the water supply to the ice maker at least one day ahead of time.
 - Disconnect the water line from the back of the refrigerator.
 - When the last load of ice drops, raise the wire shutoff arm to the OFF (up) position or move the switch to the OFF (right) setting.
2. Remove all food from the refrigerator and pack all frozen food in dry ice.
3. Empty the ice bin.
4. Depending on the model, turn the Thermostat Control or Refrigerator Control to OFF. See “Using the Controls.”
5. Unplug refrigerator.
6. Empty water from the defrost pan.
7. Clean, wipe, and dry thoroughly.
8. Take out all removable parts, wrap them well, and tape them together so they don't shift and rattle during the move.
9. Depending on the model, raise the front of the refrigerator so it rolls more easily OR screw in the leveling legs so they don't scrape the floor. See “Adjust the Doors.”
10. Tape the doors closed and tape the power cord to the refrigerator cabinet.

When you get to your new home, put everything back and refer to the “Installation Instructions” section for preparation instructions. Also, if your refrigerator has an automatic ice maker, remember to reconnect the water supply to the refrigerator.

TROUBLESHOOTING

Try the solutions suggested here first in order to avoid the cost of an unnecessary service call.

Your refrigerator will not operate

- **Is the power supply cord unplugged?** Plug into a grounded 3 prong outlet.
- **Has a household fuse blown or circuit breaker tripped?** Replace the fuse or reset the circuit breaker.
- **Is the refrigerator or freezer control turned to the OFF position?** See “Using the Controls.”
- **Is the refrigerator defrosting?** Recheck to see whether the refrigerator is operating in 30 minutes. Your refrigerator will regularly run an automatic defrost cycle.
- **Is the refrigerator not cooling?** For models with digital controls, turn the unit OFF then ON again to reset. See “Using the Controls.” If this does not correct the problem, call for service.

The lights do not work

- **Is the power supply cord unplugged?** Plug into a grounded 3 prong outlet.
- **Is a light bulb loose in the socket or burned out?** See “Changing the Light Bulbs.”
- **Is the dispenser light set to ON?** The dispenser light will operate only when the levers are pressed. If you want the dispenser light to stay on continuously, set the dispenser light to ON, or AUTO. See **Style 2** in “Water and Ice Dispensers.”
- **Is the dispenser light set to AUTO?** If the dispenser is set to the AUTO mode, be sure the dispenser light sensor is not blocked. For more information, see **Style 2** in “Water and Ice Dispensers.”

NOTE: **Style 2** dispenser lights are LEDs which should not need to be changed. If your dispenser lights are still not working, see the “Assistance or Service” section.

There is water in the defrost drain pan

- **Is the refrigerator defrosting?** The water will evaporate. It is normal for water to drip into the defrost pan.
- **Is it more humid than normal?** When it is humid, expect that the water in the defrost pan will take longer to evaporate.

The motor seems to run too much

- **Is the room temperature hotter than normal?** The motor will run longer under warm conditions. At normal room temperatures, expect your motor to run about 40% to 80% of the time. Under warmer conditions, it will run even more.
- **Has a large amount of food just been added to the refrigerator?** Adding a large amount of food warms the refrigerator. The motor normally will run longer to cool the refrigerator back down.

- **Are the doors opened often?** The motor will run longer when this occurs. Conserve energy by getting all items out at one time, keeping food organized, and closing the door as soon as possible.
- **Are the controls not set correctly for the surrounding conditions?** See “Using the Controls.”
- **Are the doors not closed completely?** Close the doors firmly. If they do not close completely, see “The doors will not close completely” later in this section.
- **Are the condenser coils dirty?** This prevents air transfer and makes the motor work harder. Clean the condenser coils. See “Cleaning.”
- **Are the door gaskets not sealed all the way around?** Contact a technician or other qualified person.

NOTE: Your new refrigerator will run longer than your old one due to its high-efficiency motor.

The refrigerator seems to make too much noise

- The sounds may be normal for your refrigerator. See “Normal Sounds.”

The ice maker is not producing ice or not enough ice

- **Has the ice maker just been installed?** Wait 72 hours for full ice production to begin. Once your refrigerator is cooled, the ice maker should produce 70 to 120 cubes every 24 hours.
- **Is the freezer temperature cold enough to produce ice?** Wait 24 hours after ice maker hookup for ice production. See “Using the Controls.”
- **Is the ice maker switch in the OFF (right) position?** Move ice maker switch to the ON (left) position. See “Ice Maker and Storage Bin.”
- **Is the water line shutoff valve to the refrigerator turned on?** Turn on the water valve. See “Connect the Water Supply.”
- **Does the ice maker mold have water in it or has no ice been produced?** Make sure your refrigerator has been connected to a water supply and the supply shutoff valve is turned on. See “Connect the Water Supply.”
- **Is an ice cube jammed in the ice maker ejector arm?** Access the ice maker by depressing the ice sensor door on the upper left side of the freezer interior. While depressing the sensor door, lift the ice maker service door and remove the ice from the ejector with a plastic utensil. See “Ice Maker and Storage Bin.”
- **Has a large amount of ice just been removed?** Allow 24 hours for ice maker to produce more ice.
- **Are the controls set correctly?** See “Using the Controls.”
- **Is there a water filter installed on the refrigerator?** The filter may be clogged or installed incorrectly. Check the filter installation instructions to ensure that the filter was installed correctly and is not clogged. If installation or clogging is not a problem, call a technician or other qualified person.

NOTE: If not due to any of the above, there may be a problem with the water line. Call for service.

Off-taste, odor or gray color in the ice

- **Are the plumbing connections new, causing discolored or off-flavored ice?** Discard the first few batches of ice.
- **Have the ice cubes been stored too long?** Throw old ice away and make a new supply.
- **Does the freezer and ice storage bin need to be cleaned?** See “Cleaning” or “Ice Maker and Storage Bin.”
- **Has food in the freezer or refrigerator been wrapped properly?** Use airtight, moisture-proof packaging to help prevent odor transfer to stored food.
- **Does the water contain minerals (such as sulfur)?** A filter may need to be installed to remove the minerals.
- **Is there a water filter installed on the refrigerator?** Gray or dark discoloration in ice indicates that the water filtration system needs additional flushing. Run additional water through the water dispenser to flush the water filtration system more thoroughly (at least 2 to 3 gal. [8 to 12 L] or 6 to 7 minutes initially). Discard discolored ice.

The ice dispenser will not operate properly

- **Is the freezer door closed completely?** Push the door firmly shut. If it will not shut all the way, see “The doors will not close completely” later in this section.
- **Is the ice storage bin installed correctly?** For models with a standard ice storage bin, push the ice storage bin in all the way. For models with an ice storage bin on the freezer door, the bin should sit level. Remove and replace the bin in the door making sure it is properly aligned and snapped securely into place. See “Ice Maker and Storage Bin.”
- **Has the wrong ice been added to the bin?** Use only cubes produced by the current ice maker. If other cubes have been added, remove all cubes and check to see that none have become stuck in the delivery chute.
- **Has the ice frozen in the ice storage bin?** Shake the ice storage bin to separate cubes. If cubes do not separate, empty bin and wait 24 hours for ice to restock.
- **Has the ice melted around the auger (metal spiral) in the ice storage bin?** Dump the ice cubes and clean the ice storage bin completely. Allow 24 hours for the ice maker to restock. Do not try to remove the melted ice with a sharp object. You could damage the ice storage bin.
- **Is ice stuck in the delivery chute?** Clear the ice from the delivery chute with a plastic utensil. Do not use anything sharp to remove the ice. You could cause damage.
- **Is the ice dispenser stalling while dispensing “crushed” ice?** Stop dispensing ice. Change the ice button from “crushed” to “cubed.” Depress the ice dispenser arm using a sturdy glass. If

cubed ice dispenses correctly, depress the button for “crushed” ice and begin dispensing again. See “Water and Ice Dispensers.”

■ **Is there ice in the storage bin?** See “The ice maker is not producing ice” earlier in this section.

■ **Has the dispenser arm been held in too long?** Release dispenser arm. Ice will stop dispensing when the arm is held in too long. Wait 3 minutes for dispenser motor to reset before using again. It is best to take large amounts of ice directly from the ice storage bin, not through the dispenser.

Ice storage bin difficult to remove

■ **Is the ice storage bin difficult to remove (on some models)?** Select “cubed” ice. Using a sturdy glass, quickly depress and release the ice dispenser arm. Open the freezer door, depress the release button on the ice storage bin and lift upward. See “Ice Maker and Storage Bin.”

The water dispenser will not operate properly

■ **Has the water system not filled?** The water system needs to be filled the first time it is used. Use a sturdy container to depress the water dispenser bar until the water begins to flow. Flush the water system by dispensing and discarding 2 to 3 gal. (8 to 12 L) of water. Cleaning the system will take approximately 6 to 7 minutes and will help clear air from the line. Additional flushing may be required in some households. See “Water and Ice Dispensers.”

■ **Is the water shutoff valve not turned on or the water line connected at the source?** Make sure the water shutoff valve is turned on and the water source is connected to the refrigerator. See “Connect the Water Supply.”

■ **Is the water shutoff valve clogged or incorrectly installed?** See “Connect the Water Supply.” If clogging or installation is not a problem, call for service or contact a plumber.

■ **Is there a kink in the home water source line?** If you find or suspect a kink in the water line, call for service.

■ **Is there a water filter installed on the refrigerator?** The filter may be clogged or incorrectly installed. First, check the filter installation instructions to ensure that the filter was installed correctly and is not clogged. If installation or clogging is not a problem, call for service.

Water or ice is leaking from the dispenser

■ **Is the glass not being held under the ice dispenser long enough, causing the ice to spill?** Hold the container under the ice chute for 2 to 3 seconds after releasing the dispenser lever. Water or ice may continue to dispense during this time.

■ **Is an ice cube stuck in the chute and holding the trap door open?** Remove the cube.

■ **Is there a water filter installed on the refrigerator?** The water filtration system may have air in the lines, causing water to drip. Additional flushing may help clear air from the lines. Normal dispenser use should flush air from the lines within 24 to 72 hours.

Water flow from the dispenser decreases noticeably

■ **Is there a water filter installed on the refrigerator?** The filter may be full or incorrectly installed. Remove the water filter cartridge. See “Water Filtration System.” Operate the dispenser. If the water flow increases noticeably, replace the filter.

The dispenser water is not cool enough

■ **Has the refrigerator been newly installed?** Allow 24 hours for the refrigerator to cool completely.

■ **Has a large amount of water been recently dispensed?** Allow 24 hours for the water to cool completely.

■ **Has water not been recently dispensed?** The first glass of water may not be cool. Discard the first glass of water.

The divider between the two compartments is warm

■ The warmth is probably due to normal operation of the automatic exterior moisture control. If still concerned, call for service.

Temperature is too warm

■ **Are the air vents blocked in either compartment?** This prevents the movement of cold air from the freezer to the refrigerator. Remove any objects from in front of the air vents. See “Ensuring Proper Air Circulation” for the location of air vents.

■ **Are the door(s) opened often?** The refrigerator will warm when this occurs. Keep the refrigerator cool by getting all items out at one time, keeping food organized, and closing the door as soon as possible.

■ **Has a large amount of food just been added to the refrigerator or freezer?** Adding a large amount of food warms the refrigerator. It can take several hours for the refrigerator to return to the normal temperature.

■ **Are the controls set correctly for the surrounding conditions?** See “Using the Controls.”

■ **Is the refrigerator not cooling?** For models with digital controls, turn the unit OFF then ON again to reset. See “Using the Controls.” If this does not correct the problem, call for service.

There is interior moisture buildup

■ **Are the air vents blocked in the refrigerator?** Remove any objects from in front of the air vents. See “Ensuring Proper Air Circulation” for the location of air vents.

■ **Are the doors opened often?** Avoid humidity buildup by getting all items out at one time, keeping food organized, and closing the door as soon as possible.

■ **Is the room humid?** It is normal for moisture to build up inside the refrigerator when the room air is humid.

■ **Is the food packaged correctly?** Check that all food is securely wrapped. Wipe off damp food containers before placing in the refrigerator.

■ **Are the controls set correctly for the surrounding conditions?** See “Using the Controls.”

■ **Was a self-defrost cycle completed?** It is normal for droplets to form after the refrigerator self-defrosts.

The doors will not close completely

■ **Are food packages blocking the door open?** Rearrange containers so that they fit more tightly and take up less space.

■ **Is the ice storage bin out of position?** For models with a standard ice storage bin, push the bin in all the way. If the ice storage bin does not go in all the way, it may not be put in straight. Pull it out and try again. For models with an ice storage bin located on the freezer door, the bin should sit level. To remove the bin, press the release button on the right side of the bin and lift straight up. Replace the bin on the door making sure it is properly aligned and snapped securely into place. See “Ice Maker and Storage Bin.”

■ **Are the pans, shelves, bins, or baskets out of position?** Put the crisper cover and all pans, shelves, bins, and baskets back into their correct positions. See the “Convertible Vegetable/Meat Drawer, Crisper and Covers” section for more information.

■ **Are the gaskets sticking?** Clean gaskets according to the directions in the “Cleaning” section.

■ **Does the refrigerator wobble or seem unstable?** Level the refrigerator. See “Adjust the Doors.”

■ **Were the doors removed during product installation and not properly replaced?** Remove and replace the doors according to the instructions in the “Refrigerator Doors” section, or call a qualified service technician.

The doors are difficult to open

■ **Are the gaskets dirty or sticky?** Clean gaskets according to the directions in the “Cleaning” section.

Warning

This content is compiled from multiple sources and is provided for reference purposes only. It may not be complete or fully applicable to all situations. If you are unable to resolve your issue, please contact the product manufacturer or an authorized service provider for official support.