

Installation

Follow these instructions carefully to ensure proper installation of your washer and to prevent accidents when doing laundry.

WARNING: Certain internal parts are intentionally not grounded and may present a risk of electric shock only during servicing. Service personnel – Do not contact the following parts while the appliance is energized: Control board, heat sink, motor, inlet valve and pump.

Unpacking your washer

Unpack your washer and inspect it for shipping damage. Make sure you have received all the items shown on the next page. If your washer was damaged during shipping, or you do not have all of the items, call 1-800-SAMSUNG (1-800-726-7864). To prevent personal injury or strain, wear protective gloves whenever lifting or carrying the unit.

WARNING: Packing materials can be dangerous to children; Keep all packing material (plastic bags, polystyrene, etc.) well out of children's reach.

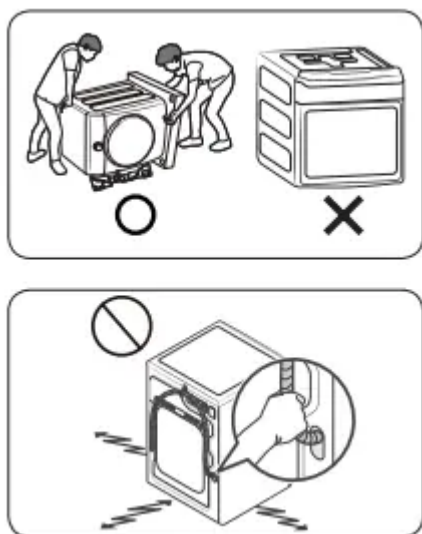

CAUTION: You must have at least 2 people unpack the washer. To remove the cushion bottom of the packing materials, do not tip the washer over on its front side. When you lay the washer down to remove the carton base, protect the side of the washer and lay it down carefully. Never lay your washer on its back or front.

CAUTION: Do not grab or pull the drain hose to drag and move the product.

What's included

Make sure all the parts are included in the product package. If you have a problem with the washer or the parts, contact the Samsung customer care center at 1-800-SAMSUNG (1-800-726-7864) or your retailer.

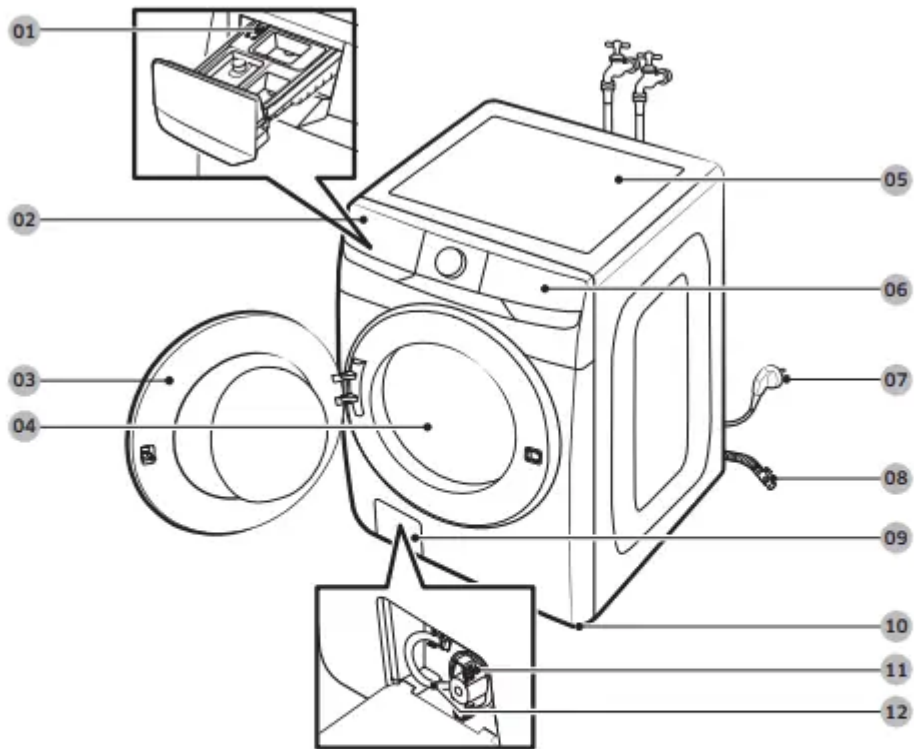

- | | | |
|------------------|---------------------|-------------------------|
| 01 Release lever | 02 Detergent drawer | 03 Door |
| 04 Drum | 05 Worktop | 06 Control panel |
| 07 Power plug | 08 Drain hose | 09 Filter cover |
| 10 Leveling feet | 11 Pump filter | 12 Emergency drain tube |

Parts supplied



Parts not supplied

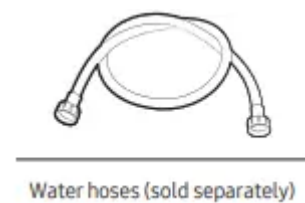

Tools needed for installation



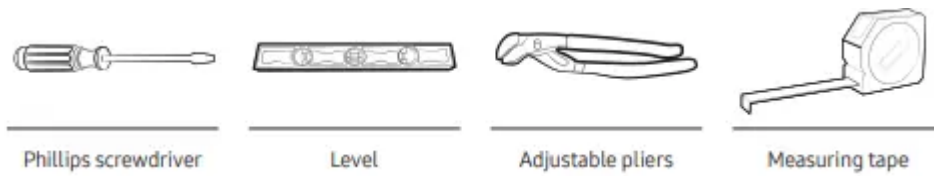

NOTE

- Bolt caps: The number (3 to 6) of bolt caps provided depends on the model.
- The appearance of the washer and provided accessories may differ with the model.
- To purchase an accessory or lost part, contact a local Samsung service center or the retailer.

CAUTION

- Do not reuse old water hoses, which may leak or burst, causing flooding and/or property damage.
- Make sure rubber washers are inserted in each coupling of both water hoses.

Installation requirements

Electrical supply and grounding

- AC 120 V / 60 Hz / 15 AMP fuse or circuit breaker is required.
- Use an individual branch circuit. Connect only the washer to the circuit.

To ensure proper grounding, the washer comes with a power cord featuring a three-prong grounding plug for use in a properly installed and grounded outlet.

Check with a qualified electrician or service person if you are not sure about the grounding.

Do not modify the provided plug. If it does not fit the outlet, call a qualified electrician to install a proper outlet.

WARNING

- Do NOT use an extension cord.
- Use only the power cord that comes with the washer.
- Do NOT connect the ground wire to plastic plumbing, gas lines, or hot water pipes.
- Improperly connected grounding conductors may cause electric shock.
- To prevent unnecessary risk of fire, electrical shock, or personal injury, all wiring and grounding must be done in accordance with local codes, or in the absence of local codes, in accordance with the National Electrical Code, ANSI/NFPA No. 70-Latest Revision (for the U.S.) or the Canadian Electrical Code CSA C22.1 – Latest Revisions and local codes and ordinances. It is your responsibility to provide adequate electrical service for your washer.

Water supply

Proper water pressure for this washer is between 20-116 psi (137-800 kPa). Water pressure less than 20 psi (137 kPa) may cause the water valve not to close completely. Or, it may take longer to fill the drum, causing the washer to turn off. Water taps must be within 4 ft. (122 cm) from the rear of the washer so that the provided inlet hoses reach the washer.

To reduce the risk of leaks:

- Make sure water taps are easily accessible.
- Turn off the taps when the washer is not in use.
- Check for any leaks at the water inlet hose fittings on a regular basis.

CAUTION: Before using the washer for the first time, check all connections at the water valve and taps for any leaks.

Drain

Samsung recommends a standpipe 18 in. (460 mm) high. The drain hose must be connected through the hose clip to the standpipe, and the standpipe must fully cover the drain hose.

Flooring

For best performance, the washer must be installed on a solid floor. Wood floors may need to be reinforced to minimize vibration and/or unbalanced loads. Carpeting and soft tile surfaces do not provide good resistance to vibrations and may cause the washer to move slightly during the spin cycle.

CAUTION: Do NOT install the washer on a platform or a poorly supported structure.

Water temperature

Do not install the washer in areas where water may freeze as the washer always retains some water in its water valves, pumps, and/or hoses. Frozen water can cause damage to belts, the pump, and other components of the washer.

Dimensions

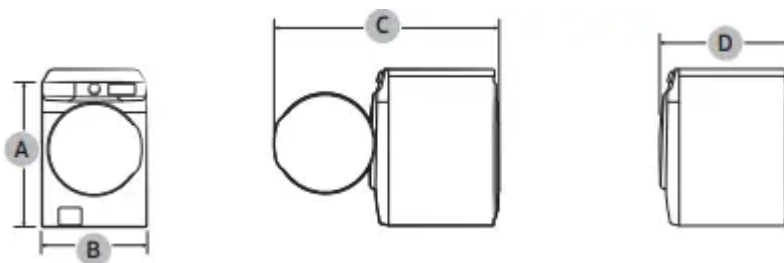

A. Overall height	38.7 in. (984 mm)
B. Width	27 in. (686 mm)
C. Depth with door open	52.6 in. (1337 mm)
D. Depth	31.3 in (796 mm)

Clearance requirement

This clearance requirement is applicable for washers only.

NOTE

- For dryer's clearance requirement, see the dryer's user manual.
- If the washer and dryer have different clearance requirements, use the one with the larger value.

Alcove or closet installations

Minimum clearance for stable operation:

Sides	Top	Rear	Front
1 in. (25 mm)	1 in. (25 mm)	5 in. (127 mm)	1 in. (25 mm)

If both the washer and a dryer are installed in the same location, the front of the alcove or closet must have two unobstructed air openings for a combined minimum total area of 72 in.² (465 cm²).

Undercounter installation

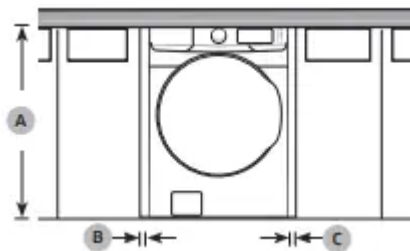

A	39.6 in. (1006 mm)
B	1 in. (25 mm)
C	1 in. (25 mm)

Pedestal installation

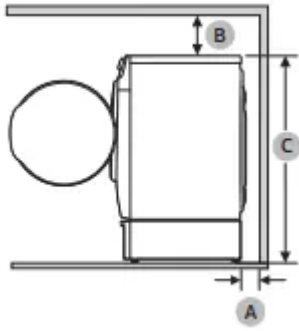

A	5 in. (127 mm)
B	6 in. (152 mm)
C	52.8 in. (1341 mm)

This clearance requirement is applicable for washer and dryer pair installation.

Side by side installation

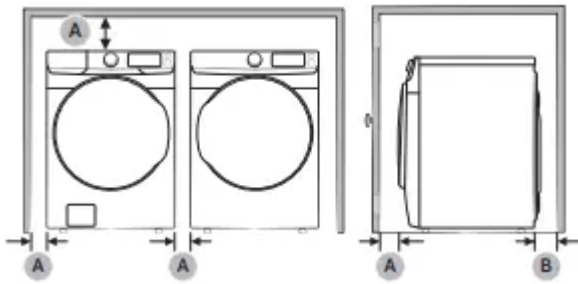

Stacked installation (Model: SKK-8K)

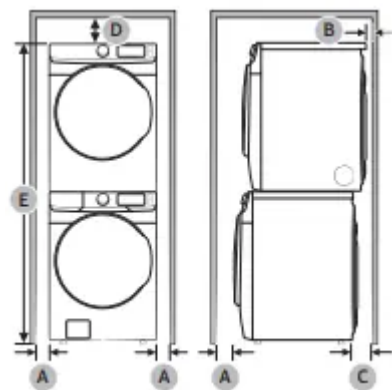

A	1 in. (25 mm)
B	5.2 in. (132 mm)
C	6.4 in. (162 mm)
D	6 in. (152 mm)
E	78.5 in. (1994 mm)

WARNING

- Samsung's washers and dryers can be stacked to maximize usable space.
- The dryer feet need to be removed to stack the washer and dryer. You can purchase an optional stacking kit from your Samsung retailer.

Step-by-step installation

STEP 1 Select a location

Location requirements:

- A solid, level surface without carpeting or flooring that may obstruct ventilation
- No direct sunlight
- Adequate room for ventilation and wiring
- Ambient temperature always higher than the freezing point (32 °F / 0 °C)
- Away from heat sources

STEP 2 Remove the shipping bolts

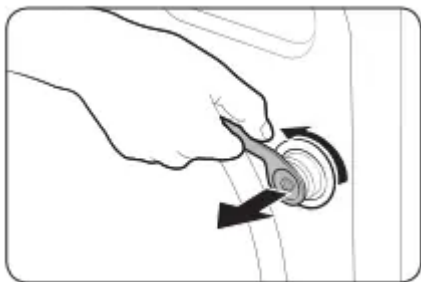

Unpack the product package and remove all shipping bolts.

1. Loosen all shipping bolts on the rear of the machine using the spanner.

NOTE: Use the enclosed end of the supplied wrench to remove the shipping bolts.

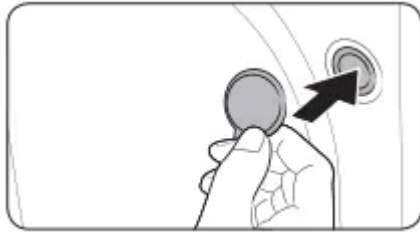

2. Fill the holes with the supplied plastic bolt caps.

Keep the shipping bolts for future use.

WARNING

- The shipping bolts secure the tub during product transportation and reduce the chance of suspension damage. Remove the shipping bolts before using the product and only reassemble them back in case you need to move the product.
- Packaging materials can be dangerous to children. Dispose all packaging material (plastic bags, polystyrene, etc.) out of children's reach.

STEP 3 Adjust the leveling feet

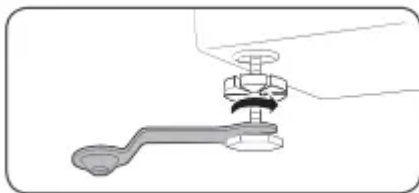

1. Gently slide the washer into position. Excessive force may damage the leveling feet.

2. Using a wrench, turn the leveling feet clockwise or counterclockwise to adjust the height until the washer is level.

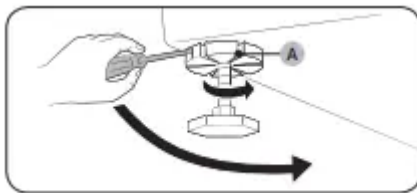

3. Using a flathead screwdriver, tighten the locking nuts (A).

NOTE: Use the open-end of the supplied wrench to adjust the leveling feet.

STEP 4 Connect the water hose

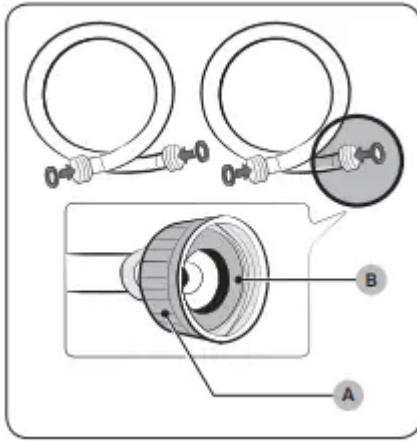

CAUTION

- Make sure to use new water hoses and that rubber gaskets (B) are inside the couplings (A) at both ends of the hoses. Water hoses without the gaskets may leak.
- Allow 5 in. (127 mm) of space between the back of the washer and the wall to prevent water hoses from being kinked. Kinked hoses may cause water leaks.
- If there is a water leak, stop using the washer and contact a local Samsung service center. A water leak may cause electric shock.
- Do not stretch the water hoses by force. If a hose is too short, replace the hose with a longer hose.

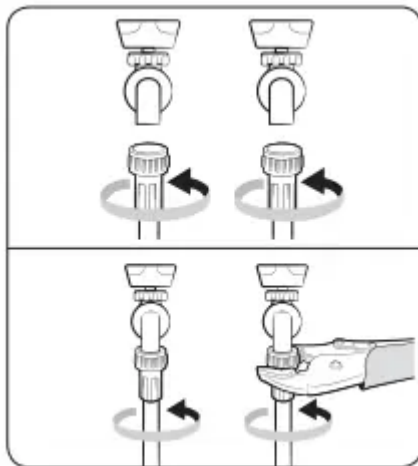

1. Attach the water hoses to the hot and cold water taps, and then hand tighten the water hose fittings until they are tight. Then, use pliers to tighten the fittings by an additional two-thirds of a turn. To avoid damaging the fittings, do not overtighten them.

2. Pull the water hoses to check if they are firmly connected.



3. Put the other ends of the hoses into a bucket, and then open the water taps for 10 - 15 seconds to remove impurities. When done, close the taps.

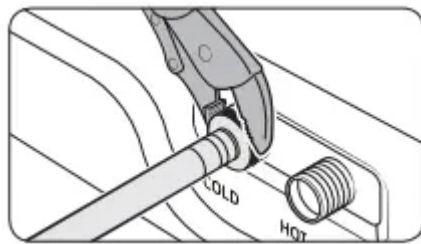

4. Attach the water hoses to the hot and cold water inlets on the back of the washer, and then hand tighten the water hose fittings until they are tight. Then, use pliers to tighten the fittings by an additional two-thirds of a turn.

NOTE: If you do not want to use the hot water supply hose, attach the water intake cap to the hot water supply intake. When you do a wash, press **Temp.** to select Cold.

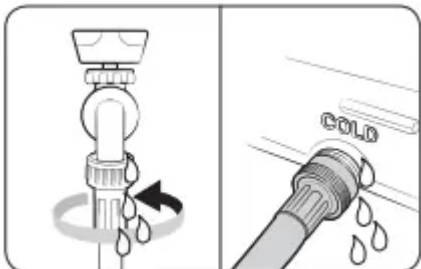

5. Open the water taps, and check for leaks.

STEP 5 Connect the drain hose

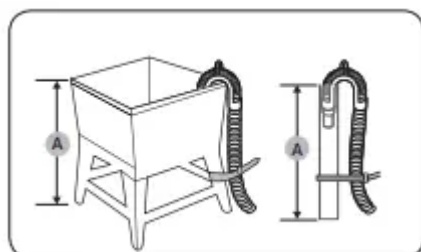

To a Laundry Tub or Drain Pipe

1. Check the height (A) of your drain system and make sure the minimum and maximum heights shown below are met.

Minimum	18 in. (46 cm)
Maximum	96 in. (245 cm)

NOTE

- Make sure to measure the height from the floor where the washer is placed.
- Draining efficiency may be reduced if the drain system is at the maximum height.
- To prevent the washer from siphoning water, do not use a drain system below the minimum height.

2. Attach the drain hose to the **plastic hose guide (B)**.

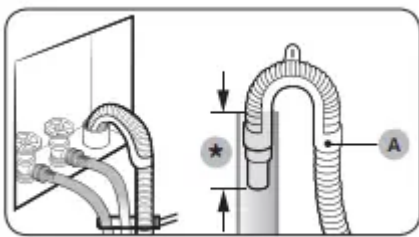
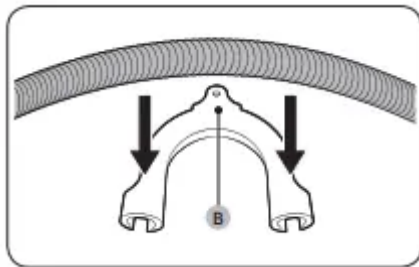

(*): Min. 6 in. (152 mm), Max. 8 in. (203 mm)

3. Route the drain hose to the drain system.

CAUTION

- If using a standpipe, make sure the standpipe and drain hose connection is not airtight.
- If using a standpipe, make sure the drain hose is inserted at least 6 in. (152 mm) but no more than 8 in. (203 mm) into the standpipe.

4. Secure the drain hose with cable ties. Route the drain hose to the drain system.



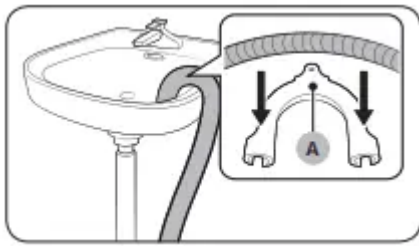

Over the edge of a wash basin

The drain hose must be placed no lower than 24 in. (60 cm) and no higher than 35 in. (90 cm) from the floor. To keep the spout of the drain hose bent, use the supplied plastic **hose guide (A)**. Secure the guide to the wall using a hook to ensure stable drainage.

STEP 6 Remove the film inside the door

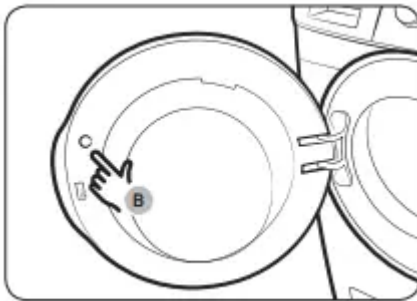

Remove the **small circle of film (B)** above the door latch before use.

STEP 7 Power on

Plug the power cord into an AC 120 V / 60 Hz / 15 AMP approved electrical outlet protected by a fuse or circuit breaker. Then, press **Power** to turn on the washer.

Operations

WARNING: To reduce the risk of fire, electric shock, or injury to persons, read the Safety information before operating this appliance.

Control panel

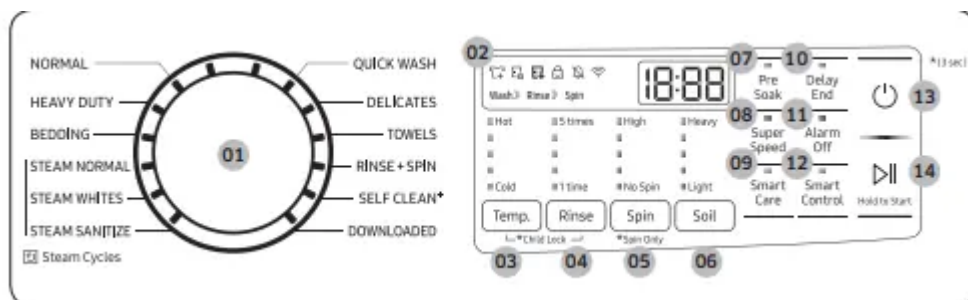







01 Cycle Selector	Turn the dial to select a cycle. (For more information about wash cycles, see page 37.)
02 Display	The display shows current cycle information and estimated time remaining, or an information code if the washer needs to be checked.
03 Temp.	Press to change the water temperature for the current cycle. <ul style="list-style-type: none"> • Hot (Level 5): Heavily soiled, colorfast items. • (Level 4): Whites and heavily soiled, colorfast items. • (Level 3): Colorfast items. • (Level 2): Brightly colored, very lightly soiled items. • Cold (Level 1): Uses only cold water without utilizing the washer's heater. No warm water is supplied.
04 Rinse	Press to change the rinse count for the current cycle. <ul style="list-style-type: none"> • You can select 1 to 5 rinses.

05 Spin	Press to change the spinning speed for the current cycle. <ul style="list-style-type: none"> • High (Level 5): Extends the spinning process to effectively remove moisture from the load. This level uses a stronger spinning process to remove moisture, so it is not suitable for wrinkle-free or non-iron fabrics, or overloads. • (Level 4): Underwear, t-shirts, jeans, and sturdy cottons. • (Level 3): Jeans, wrinkle-free or wash-and-wear items, and synthetics. • (Level 2): Delicate items that require a lower spinning speed. • No Spin (Level 1): The drum does not spin after the final drain process. <p>Rinse hold (All indicators are off): The final rinse process is suspended so that the laundry remains in the water. To unload the laundry, run a drain or spin process.</p> <p> NOTE</p> <p>Spin Only: To perform the spin process only, press and hold Spin for 3 seconds. With the cycle time on the display, press Spin repeatedly until a desired spinning speed is selected. Then, press and hold Start/Pause (Hold to Start) to start.</p>
06 Soil	Press to change the soil level for the current cycle. <ul style="list-style-type: none"> • Heavy (Level 5): For extremely soiled loads. • (Level 4): For heavily soiled loads. • (Level 3): For moderately soiled loads. This setting is best for most loads. • (Level 2): For lightly soiled loads. • Light (Level 1): For barely soiled loads.
07 Pre Soak	Press to add 30 minutes of soaking time at the start of the wash cycle for better stain removal.
08 Super Speed	Press this button if you need to shorten the washing time, applicable for NORMAL, HEAVY DUTY, BEDDING or STEAM WHITES . The shortened time may differ depending on the selected cycle/load/options.
09 Smart Care	This function enables you to check the status of the washer using a smartphone.
10 Delay End	Set the washer to finish your wash automatically at later time. Choose a delay of between 1 to 24 hours (in 1 hour increments). (For more information about Delay End, see page 40.)
11 Alarm Off	Press to turn the alarm sound on or off. When the alarm is off, the cycle completion melody and the power-off beep will not sound. However, button and alert sounds will remain on.

12 Smart Control	After connecting the washer to your home network using the SmartThings app, you can control the washer remotely. When started, the Smart Control indicator blinks and the front door locks. The washer enters waiting mode and waits for remote commands. (For more information about Smart Control, visit the SmartThings app page.)
13 Power	Press to turn the washer on or off.
14 Start/Pause (Hold to Start)	Press and hold to start operation or press to stop operation temporarily.

Icon description

	Garment+	<ul style="list-style-type: none"> This icon indicates you can add or take out items after a cycle has started. To add or take out items, press Start/Pause (Hold to Start) to pause the cycle, and then open the door. To resume the cycle, close the door, and then press and hold Start/Pause (Hold to Start).
	Door Lock	<ul style="list-style-type: none"> This icon indicates the door is locked and cannot be opened. The door locks automatically during a cycle and this indicator turns on. You can open the door when this icon disappears.
	SELF CLEAN+ reminder	<ul style="list-style-type: none"> This icon indicates that you should clean the drum using the SELF CLEAN+ cycle. After every 40 cycles, this icon appears for an hour and then turns off automatically. The icon will appear for 5 more cycles, turn off, and then will not appear for another 40 cycles.
	Child Lock	<ul style="list-style-type: none"> This icon indicates that Child Lock is on. For more information on Child Lock, see page 41.
	Alarm Off	<ul style="list-style-type: none"> This icon indicates that the alarm is off. For more information on Alarm Off, see page 41.
	Wi-Fi	<ul style="list-style-type: none"> This icon indicates that the washer is connected to Wi-Fi.

Simple steps to start

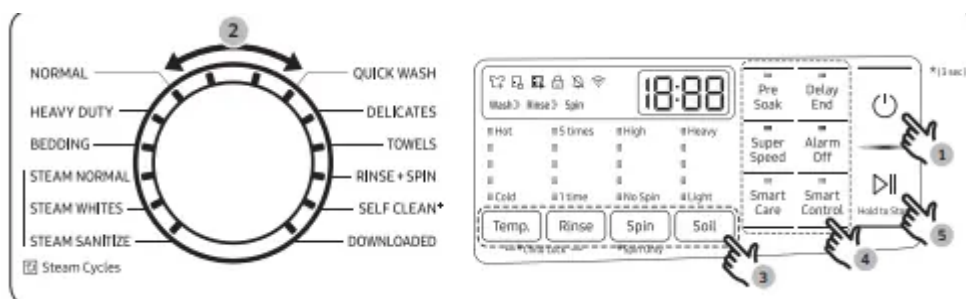

1. Press **Power** to turn on the washer.
2. Turn the **Cycle Selector** to select a cycle.
3. Change the cycle settings (**Temp.**, **Rinse**, **Spin**, and **Soil**) as necessary.
4. Select desired options as necessary.
5. Press and hold **Start/Pause (Hold to Start)**.

To change the cycle during operation

1. Press **Start/Pause (Hold to Start)** to stop operation.
2. Select a different cycle.
3. Press and hold **Start/Pause (Hold to Start)** again to start the new cycle.

WARNING: Do not place anything on top of your washer while it is running.

Cycle overview

NOTE: The washer detects the weight of the items and automatically adjusts the optimal water level, washing time, rinse counts, and spin counts. (This may not be applicable on some cycles.)

Cycle	Description
NORMAL	<ul style="list-style-type: none">• For cottons, bed linens, table linens, underwear, towels, or shirts. The washing time and the number of rinses are automatically adjusted according to the load.
HEAVY DUTY	<ul style="list-style-type: none">• For sturdy, colorfast fabrics and heavily soiled items.
BEDDING	<ul style="list-style-type: none">• For bulky items such as comforters, blankets, and sheets.• For best results, wash only 1 type of bedding.• For bulky items, use liquid detergent and do not roll the items in the drum because they might get stuck in the drum.
STEAM NORMAL	<ul style="list-style-type: none">• For washing everyday garments with steam.
STEAM WHITES	<ul style="list-style-type: none">• For white items. You can wash with or without bleach.
STEAM SANITIZE	<ul style="list-style-type: none">• For colourfast fabrics and heavily soiled laundry, this cycle heats the supplied water over 60 °C to clean deeply.• If you stop running the cycle while the washer is heating the water, the door remains locked for your safety.
QUICK WASH	<ul style="list-style-type: none">• For lightly soiled items that you want to finish washing quickly.• For best performance, recommended load is 4 lb (2.0 kg) or lower.
DELICATES	<ul style="list-style-type: none">• For sheer fabrics, bras, lingerie (silk), and other handwash-only fabrics.• For best performance, use liquid detergent.
TOWELS	<ul style="list-style-type: none">• For bath towels, washcloths, and mats.
RINSE+SPIN	<ul style="list-style-type: none">• Features an additional rinse process after fabric softener is applied to the laundry.
SELF CLEAN⁺	<ul style="list-style-type: none">• Cleans the drum by removing dirt and bacteria from the drum.• Perform once every 40 washes.• Make sure the drum is empty.
DOWNLOADED	<ul style="list-style-type: none">• Select to choose from more cycles available on the SmartThings app on your smartphone.• Available cycles: ACTIVEWEAR, STEAM ALLERGEN, WOOL, ECO COLD, POWER STEAM, STEAM BULKY, OUTDOOR, DENIM, PERM PRESS, COLORS, POWER RINSE.• Factory setting: ACTIVEWEAR

Cycle chart

Use this chart to set the best cycle and options for your laundry.

NOTE

Setting	Temp.	Rinse	Spin	Soil
● : factory setting	5 : Hot (Level 5)	5 : 5 times (Level 5)	5 : High (Level 5)	5 : Heavy (Level 5)
○ : can be selected	4 : (Level 4)	4 : (Level 4)	4 : (Level 4)	4 : (Level 4)
	3 : (Level 3)	3 : (Level 3)	3 : (Level 3)	3 : (Level 3)
	2 : (Level 2)	2 : (Level 2)	2 : (Level 2)	2 : (Level 2)
	1 : Cold (Level 1)	1 : 1 time (Level 1)	1 : No spin (Level 1)	1 : Light (Level 1)
		0 : 0 time	0 : No drain	

Cycle	Functions											
	Temp.					Rinse						
	5	4	3	2	1	5	4	3	2	1	0	
NORMAL	○	○	●	○	○	○	○	○	○	●	○	○
HEAVY DUTY	○	●	○	○	○	○	○	○	○	●	○	○
BEDDING			●	○	○	○	○	○	○	●	○	○
STEAM NORMAL		●				○	○	○	○	●	○	○
STEAM WHITES		●				○	○	○	○	●	○	○
STEAM SANITIZE	●					○	○	○	○	●	○	○
RINSE+SPIN						○	○	○	○	○	●	○
TOWELS		○	●	○	○	○	○	○	○	●	○	○
DELICATES			○	○	●			○	○	●	○	○
QUICK WASH		○	●	○	○	○	○	○	○	○	●	○
SELF CLEAN ⁺	●									●		

Cycle	Functions										
	Spin						Soil				
	5	4	3	2	1	0	5	4	3	2	1
NORMAL	○	●	○		○	○	○	○	●	○	○
HEAVY DUTY	●	○	○	○	○	○	●	○	○	○	○
BEDDING			○	●	○	○	○	○	●	○	○
STEAM NORMAL	○	●	○	○	○	○	○	○	○	●	○
STEAM WHITES	○	●	○	○	○	○	○	○	○	●	○
STEAM SANITIZE	○	●	○	○	○	○	○	○	○	●	○
RINSE+SPIN	○	●	○	○	○	○					
TOWELS	○	●	○	○	○	○	○	○	○	●	○
DELICATES			●	○	○	○	○	○	○	●	○
QUICK WASH	●	○	○	○	○	○	○	○	○	○	●
SELF CLEAN ⁺	●										



Cycle	Options	
	Superspeed	Pre Soak
NORMAL	<input type="radio"/>	<input type="radio"/>
HEAVY DUTY	<input type="radio"/>	<input type="radio"/>
BEDDING	<input type="radio"/>	<input type="radio"/>
STEAM NORMAL		<input type="radio"/>
STEAM WHITES	<input type="radio"/>	<input type="radio"/>
STEAM SANITIZE		<input type="radio"/>
RINSE+SPIN		
TOWELS		<input type="radio"/>
DELICATES		
QUICK WASH		
SELF CLEAN ⁺		

Special features

Delay End

You can set the washer to finish your wash automatically at a later time by choosing a delay of between 1 to 24 hours (in 1 hour increments). The hour displayed indicates the time the wash will finish.

1. Select a cycle. Then, change the cycle settings if necessary.
2. Press **Delay End** repeatedly until a desired end time is set.
3. Press and hold **Start/Pause (Hold to Start)**.
4. To cancel Delay End, restart the washer by pressing **Power**.

Real-life case

You want to finish a two-hour cycle 3 hours from now. To do this, you add the Delay End option to the current cycle with a 3-hour setting, and then press and hold **Start/Pause (Hold to Start)** at 2:00 pm. The washer starts operating at 3:00 pm and ends at 5:00 pm. Provided below is the time line for this example.



ATC (Auto Temperature Control)

ATC enables the washer to control water temperatures in each washing cycle using the internal thermistor. It is designed to maintain certain washing temperatures for best results.

NOTE

- If you select **NORMAL** or **HEAVY DUTY**, you may notice the washer supplying cold water. This is normal because the machine is designed to reduce power consumption. In

these cycles, the water temperature for Level 5 is similar to bath-water temperatures, and Level 3 is similar to comfortable swimming pool temperatures.

- To wash clothes at a specific temperature, you must choose a different cycle first.

Child Lock

The Child Lock function locks the washer door to prevent children from climbing into and suffocating inside the drum.

To activate Child Lock

- Press and hold both **Temp.** and **Rinse** for 3 seconds. Then, press and hold **Start/Pause (Hold to Start)** to activate. The door locks, and the Child Lock indicator turns on.

To deactivate Child Lock temporarily

- You can deactivate Child Lock temporarily for 1 minute. To do this, press and hold both **Temp.** and **Rinse** for 3 seconds. The door is unlocked for 1 minute and the Child Lock indicator blinks.

NOTE

- If you open the door 1 minute after deactivating Child Lock, an alarm sounds for up to 2 minutes.
- If you close the door within 2 minutes, the door locks and Child Lock is reactivated. If you do not close the door or the door is not properly closed, the alarm keeps sounding for 2 minutes.
- To add laundry after activating Child Lock, deactivate Child Lock or restart the washer.

To cancel Child Lock

- Press and hold both **Temp.** and **Rinse** for 6 seconds. The door unlocks, and the Child Lock indicator turns off.

Alarm Off

You can turn the alarm sound on or off. When the alarm is off, the cycle completion melody and the poweroff beep will not sound. However, the other sounds stay active.

- Press Alarm Off to turn the alarm on or off.
- Your setting will be kept even after you turn off and then restart the appliance.

DOWNLOADED cycle

You can choose from more cycles available on the SmartThings app on your smartphone.

1. On your smartphone, select the **DOWNLOADED** cycle.

- You can choose from ACTIVEWEAR, STEAM ALLERGEN, WOOL, ECO COLD, POWER STEAM, STEAM BULKY, OUTDOOR, DENIM, PERM PRESS, COLORS, POWER RINSE.

2. Press **Power** on your washer.
3. Turn the **Cycle Selector** to **DOWNLOADED**.
4. Press and hold **Start/Pause (Hold to Start)**.

SmartThings

Wi-Fi connection

On your smartphone, go to **Settings** and turn on the wireless connection and select an AP (Access Point).

- This appliance supports the Wi-Fi 2.4 GHz protocols.

Download

On an app market (Google Play Store, Apple App Store, Samsung Galaxy Apps), find the SmartThings app by searching for “SmartThings”. Download and install the app on your device.

NOTE: The app is subject to change without notice for improved performance.

Log in

You must first log into SmartThings with your Samsung account. To create a new Samsung account, follow the instructions on the app. You don't need a separate app to create your account.

NOTE: If you have a Samsung account, use the account to log in. A registered Samsung smartphone user automatically logs in.

To register your appliance to SmartThings

1. Make sure your smartphone is connected to a wireless network. If not, go to **Settings** and turn on the wireless connection and select an AP (Access Point).
2. Open **SmartThings** on your smartphone.
3. If a message of “**A new device is found.**”, select **Add**.
4. If no message appears, select + and select your appliance in a list of devices available. If your appliance is not listed, select **Device Type > Specific Device Model**, and then add your appliance manually.
5. Register your appliance to the SmartThings app as follows.
 - a. Add your appliance to SmartThings. Make sure your appliance is connected to SmartThings.
 - b. When registration is complete, your appliance appears on your smartphone.

Maintenance

Keep the washer clean for best performance and to lengthen its life cycle.

WARNING: Certain internal parts are intentionally not grounded and may present a risk of electric shock only during servicing. Service personnel – Do not contact the following parts while the appliance is energized: Control board, heat sink, motor, inlet valve and pump.

SELF CLEAN⁺

Certain usage and environmental conditions may result in some residue build-up or odor in the washer drum. To prevent this build-up of residue or odor causing bacteria and keep your washer drum fresh and clean, perform the SELF CLEAN⁺ cycle at least once a month or every 40 cycles. Perform the recommended procedure below when using the SELF CLEAN cycle.

1. Remove all items from the washer drum and ensure the drum is empty. Laundry left in the drum during the SELF CLEAN⁺ cycle may be damaged.
2. Press **Power** to turn on the washer.
3. Turn the **Cycle Selector** to **SELF CLEAN⁺**.
4. Press and hold **Start/Pause (Hold to Start)**.

NOTE

- The water temperature for SELF CLEAN⁺ is defaulted to Hot. This temperature cannot be changed.
- In the case where residue is present in the washer drum, add liquid chlorine bleach to the MAX level line in the main-wash compartment before starting the SELF CLEAN⁺ cycle. Do not add the liquid chlorine bleach to the bleach compartment (This is only the case for SELF CLEAN⁺ cycle).
- Do not exceed the max line. Do not use or mix any other detergent or chemicals during the SELF CLEAN⁺ cycle. If necessary, run a RINSE+SPIN cycle after the SELF CLEAN⁺ cycle has completed to help remove any remaining residue.

CAUTION: If there is chlorine bleach left in the washer drum for an extended period of time, rust can occur.

SELF CLEAN⁺ reminder

- After 40 washing cycles, the SELF CLEAN⁺ LED reminder icon and the SELF CLEAN⁺ cycle LED will blink on the control panel for an hour and then turn off automatically.
- The reminder will appear on the control panel for 5 additional consecutive cycles before turning off. The next reminder will not appear until another 40 cycles have been completed.

Smart Care

To enable this function, you must first download the Samsung Laundry app from the Play Store or the App Store and install it on a mobile device that has a camera function. The Smart Care function has been optimized for Galaxy and iPhone mobile devices (applicable models only).

1. When the washer detects an issue to check, an information code appears on the display. To enter Smart Care mode, press **Smart Care**.
2. The washer starts the self-diagnosis procedure and displays an information code if a problem is detected.
3. Run the Samsung Laundry app on your mobile device, and then tap **Smart Care**.
4. Put the mobile device close to the washer's display so that the smartphone camera and the washer face each other. The information code will be recognized automatically by the app.
5. When the information code is recognized correctly, the app provides detailed information about the problem with applicable solutions.

NOTE

- The function name, Smart Care, may differ depending on the language.
- If the washer's display reflects light, the app may fail to recognize the information code.
- If the app fails to recognize the information code, you can enter the code manually on the app.

Emergency drain

In case of a power failure, drain the water inside the drum before taking out the laundry

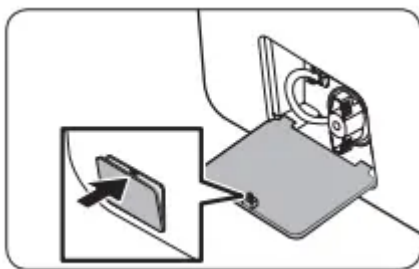

1. Turn off the washer, and then unplug the power cord.
2. Gently press the top area of the **filter cover** to open.

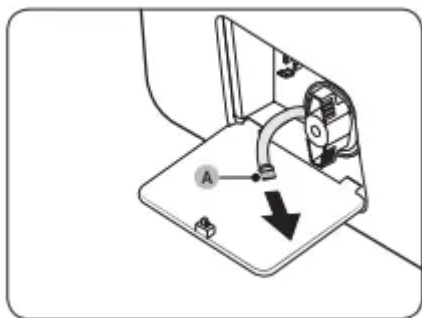

3. Put an empty, spacious container around the cover, and stretch the **emergency drain tube** to the container while holding the **tube cap (A)**.

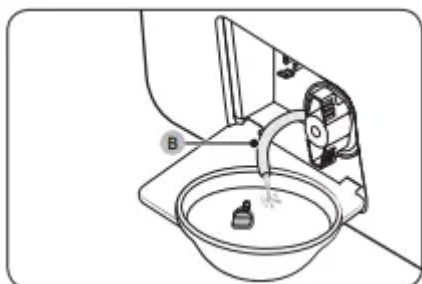

4. Open the **tube cap** and let water in the **Emergency drain tube (B)** flow into the container.

5. When done, close the **tube cap**, and reinsert the tube. Then, close **the filter cover**.

NOTE: Use a spacious container because the water in the drum may be more than expected

Cleaning

Surface of the washer

Use a soft cloth with a nonabrasive household cleaner. Do not spray water onto the washer.

Mesh filter

Clean the mesh filter of the water hose once or twice a year.

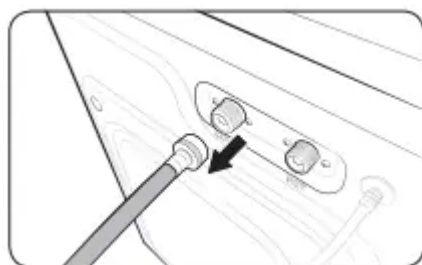

1. Turn off the washer, and then unplug the power cord.

2. Close the water tap.

3. Loosen and disconnect the water hoses from the back of the washer. Cover the end of each hose with a cloth or towel to prevent water from gushing out.

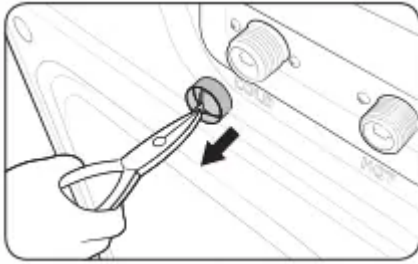

4. Use pliers to pull out the mesh filter from the inlet valves.

5. Thoroughly clean the mesh filters in water.

6. Completely dry the mesh filters. Do not dry in direct sunlight.

7. Reinsert the mesh filters, and then reconnect the water hoses.

8. Open the water taps.

NOTE: If a mesh filter is clogged, the “4C” information code appears on the washer’s display screen

Pump filter

You should clean the pump filter 5 or 6 times a year to prevent it from clogging. A clogged pump filter may reduce the bubble effect.

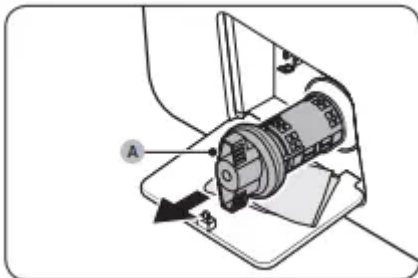

1. Turn off the washer, and then unplug the power cord.

2. Gently press the top area of the **filter cover** to open.

3. Drain the remaining water inside the drum. See the **Emergency drain** section on page 45.

4. Turn the **pump filter knob (A)** counterclockwise, and then drain the remaining water.

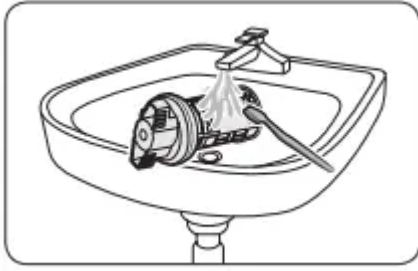

5. Clean the pump filter using a soft brush. Make sure the drain pump propeller inside the filter is not clogged.
6. Reinsert the pump filter, and then turn the filter knob clockwise.
7. Close the filter cover.

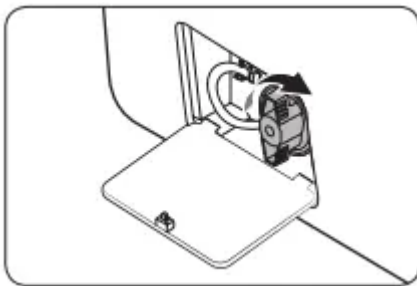

NOTE

- Some pump filters feature a safety knob that is designed to prevent children from accidentally opening the filter compartment. To open the safety knob of the **pump filter**, push in and turn it counterclockwise. The spring mechanism of the safety knob helps open the filter.
- Before closing the **filter cover**, make sure the **pump filter** is properly inserted.

NOTE: If the pump filter is clogged, the “5C” information code appears on the washer’s display screen.

CAUTION

- Make sure the filter knob is closed properly after cleaning the filter. Otherwise, this may cause a leak.
- Make sure the filter is inserted properly after cleaning it. Otherwise, this may cause an operational failure or a leak.

Detergent drawer

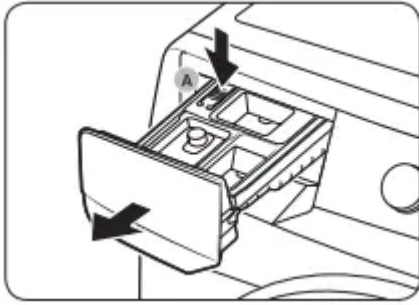

1. Open the drawer.
2. While holding down the **release lever (A)**, remove the drawer.
3. Remove the **liquid detergent container** from the drawer.

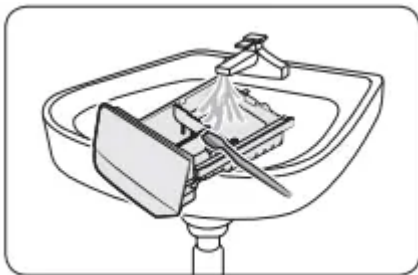

4. Clean the drawer components in running water using a soft brush.

NOTE: Other parts of the drawer can also be removed. They can fall out if you hold the drawer upside down.

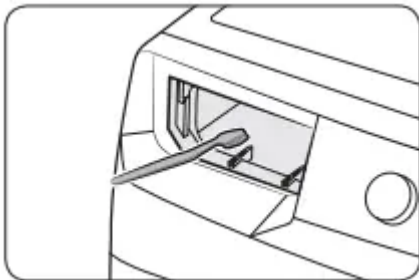

5. Clean the drawer recess using a soft brush.
6. Reinsert the **liquid detergent container** into the detergent drawer.
7. Slide the drawer into the drawer recess, and then push it inward until it is fully closed.

NOTE: To remove remaining detergent, run the **RINSE+SPIN** cycle with the drum empty.

Door diaphragm

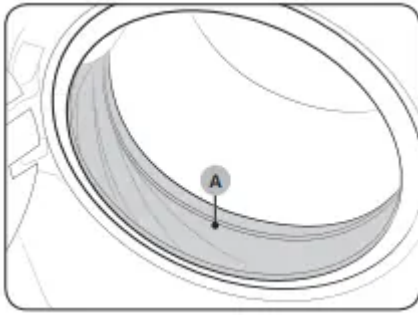

1. Open the door, and then empty the drum.
2. Combine 3/4 cups of liquid chlorine bleach and 1 gallon of warm tap water.
3. Wearing rubber gloves, use a soft, clean cloth dipped in the water and bleach solution to clean the diaphragm.
4. Let stand 5 minutes, and then wipe up and dry well.

CAUTION: Use bleach carefully and be sure to follow the bleach manufacturer's use and care instructions.

Recovery from freezing

The washer may freeze when the temperature in its location drops below 32 °F (0 °C).

1. Turn off the washer, and then unplug the power cord.
2. Pour warm water over the water tap to loosen the water hose.
3. Disconnect the water hose, and then soak it in warm water.
4. Pour warm water into the drum and leave it for about 10 minutes.
5. Reconnect the water hose to the water tap.

NOTE: If the washer still doesn't operate normally, repeat the steps above.

Care for an extended period of non-use

Avoid leaving the washer unused for an extended time. However, if you intend to leave the washer unused for a long period of time, follow the directions below:

1. Press **Power**, and then turn the **Cycle Selector** to **RINSE+SPIN**.
2. Empty the drum, and then press and hold **Start/Pause (Hold to Start)**.
3. When the cycle is complete, close the water taps and disconnect the water hoses.
4. Turn off the washer, and then unplug the power cord.
5. Open the door to let air circulate through the drum.

Cleaning the exterior

1. Turn off the water taps after finishing the day's washing.

This will shut off the water supply to your washer and prevent the unlikely possibility of damage from escaping water. Leave the door open to allow the inside of your washer to dry out.

2. Use a soft cloth to wipe up all detergent, bleach, or other spills as they occur. Clean the following as recommended below:

- Control Panel – Clean with a soft, damp cloth. Do not use abrasive powders or cleaning pads. Do not spray cleaners directly on the panel.
- Cabinet – Clean with soap and water.

Cleaning the interior

Clean the interior of your washer periodically to remove any dirt, soil, odor, mold, mildew, or bacterial residue that may remain in your washer as a result of washing clothes.

CAUTION: Failure to follow these instructions may result in unpleasant conditions, including odors and/or permanent stains on your washer or laundry.

NOTE: Hard water deposits may be removed, if needed. Use a cleaner labeled “Washer safe”.

Troubleshooting

Checkpoints

If you encounter a problem with the washer, first check the table below and try the suggestions.

Problem	Action
Does not start.	<ul style="list-style-type: none"> • Make sure the washer is plugged in. • Make sure the door is properly closed. • Make sure the faucets are open. • Make sure to press or tap Start/Pause (Hold to Start) to start the washer. • Make sure Child Lock is not activated. • Before the washer starts to fill, it will make a series of clicking noises to check the door lock and does a quick drain. • Check the fuse or reset the circuit breaker.
Water supply is insufficient, or no water is supplied.	<ul style="list-style-type: none"> • Fully open the faucet. • Make sure the door is properly closed. • Make sure the water supply hose is not frozen. • Make sure the water supply hose is not kinked or clogged. • Make sure there is sufficient water pressure.
After a cycle, detergent remains in the detergent drawer.	<ul style="list-style-type: none"> • Make sure the washer is running with sufficient water pressure. • Make sure you add liquid detergent to the liquid detergent container. Make sure to remove the liquid detergent container if you are using powdered detergent. • Clean the detergent drawer.
Excessive vibrations or makes noise.	<ul style="list-style-type: none"> • Make sure the washer is installed on a level, solid floor that is not slippery. If the floor is not level, use the leveling feet to adjust the height of the washer. • Make sure the shipping bolts are removed. • Make sure the washer is not contacting any other object. • Make sure the laundry load is balanced. • The motor can cause noise during normal operation. • Overalls or metal-decorated clothes can cause noise while being washed. This is normal.



	<ul style="list-style-type: none"> • Metal objects such as coins can cause noise. After washing, remove these objects from the drum or filter case. • Remove the filling of the pillows and cushions, and wash only the covers.
<p>Does not drain and/ or spin.</p>	<ul style="list-style-type: none"> • Make sure the drain hose is neither kinked nor obstructed all the way to the drain system. If there is a drain restriction, call for service. • Make sure the debris filter is not clogged. • Close the door and press or tap Start/Pause (Hold to Start). For your safety, the washer will not tumble or spin unless the door is closed. • Make sure the drain hose is not frozen or clogged. • Make sure the drain hose is connected to a drain system that is not clogged. • If the washer is not supplied with sufficient power, the washer temporarily will not drain or spin. As soon as the washer regains sufficient power, it will operate normally. • Make sure the drain hose is inserted 6 to 8 inches inside the drain pipe. • Make sure the washer is level.
<p>The door does not open</p>	<ul style="list-style-type: none"> • Press or tap Start/Pause (Hold to Start) to stop the washer. • It may take a few moments for the door lock mechanism to disengage. • Make sure all the water in the drum is drained. • The door may not open if water remains in the drum. Drain the drum and open the door manually. • Make sure the door lock light is off. The door lock light turns off after the washer has drained. • If the washer is paused after the water is supplied, the door cannot be opened until one minute has passed. If draining occurs followed by the information code on the display, the door will not open until 3 minutes after the washer has stopped or the power is turned off. • The door does not open if you have unplugged the power cord while the product was operating. <ul style="list-style-type: none"> - Plug the power cord and turn on the power. Then, deactivate Child Lock if necessary, and then press and hold Start/Pause (Hold to Start) to stop the operation.



<p>Excessive suds.</p>	<ul style="list-style-type: none"> • Make sure you use the recommended types and amounts of detergent. • Use high efficiency (HE) detergent to prevent oversudsing. • Reduce the detergent amount for soft water, small loads, or lightly soiled loads. • Don't use Non-HE detergent.
<p>Cannot add additional detergent.</p>	<ul style="list-style-type: none"> • Make sure the remaining amount of detergent and fabric softener is not over the limit.
<p>The washer stops.</p>	<ul style="list-style-type: none"> • Plug the power cord into a live electrical outlet. • Check the fuse or reset the circuit breaker. • Close the door and press Start/Pause (Hold to Start) to start the washer. For your safety, the washer will not tumble or spin unless the door is closed. • Before the washer starts to fill, it will make a series of clicking noises to check the door lock and does a quick drain. • There may be a pause or soak period in the cycle. Wait briefly and the washer may start. • Make sure the mesh filter of the water supply hose at the faucets is not clogged. Periodically clean the mesh filter. • If the washer is not supplied with sufficient power, the washer temporarily will not drain or spin. As soon as the washer regains sufficient power, it will operate normally



<p>Fills with the wrong temperature water.</p>	<ul style="list-style-type: none"> • Fully open both taps. • Make sure the temperature selection is correct. • Make sure the hoses are connected to the correct taps. Flush water lines. • Make sure your water heater is set to supply hot water with a minimum temperature of 120 °F (49 °C) at the tap. Also, check the water heater capacity and recovery rate. • Disconnect the hoses and clean the mesh filters. The mesh filters may be clogged. • While the washer fills, the water temperature may change as the automatic temperature control feature checks incoming water temperature. This is normal. • While the washer fills, you may notice just hot and/or just cold water going through the dispenser when cold or warm temperatures are selected. This is a normal function of the automatic temperature control feature as the washer determines the water temperature.
<p>The load is wet at the end of a cycle.</p>	<ul style="list-style-type: none"> • Use the High or Extra High spin speed. • Use high efficiency (HE) detergent to reduce oversudsing. • The load is too small. Small loads (one or two items) may become unbalanced and not spin completely. • Make sure the drain hose is not kinked or clogged.
<p>Leaks water.</p>	<ul style="list-style-type: none"> • Make sure the door is properly closed. • Make sure all hose connections are tight. • Make sure the end of the drain hose is correctly inserted and secured to the drain system. • Avoid overloading. • Use high efficiency (HE) detergent to prevent oversudsing.
<p>Has odors.</p>	<ul style="list-style-type: none"> • Excessive suds collect in recesses and can cause foul odors. • Run cleansing cycles to sanitize periodically. • Clean the door seal (diaphragm). • Dry the washer interior after a cycle has finished.



After a cycle, washer is not off and/or the door does not open.	<ul style="list-style-type: none">• If the Remaining Laundry Notification is on, press Power to turn the power off, and then remove the items.• If the SELF CLEAN+ indicator is on, remove all items from the drum, and then run the SELF CLEAN+ cycle.
--	---

If a problem persists, contact a local Samsung service center.

Information codes

If the washer fails to operate, you may see an information code on the screen. Check the table below and try the suggestions.

Code	Action
1C	<p>Check the water level sensor.</p> <ul style="list-style-type: none"> • Power the washer off. Wait 2-3 minutes, power the washer on, and then try again. • Depending on the model, the drain system may drain water automatically. The Power and Start/Pause (Hold to Start) buttons may be disabled during this process.
DC	<p>The door is open.</p> <ul style="list-style-type: none"> • Close the door and press Start/Pause (Hold to Start) to resume operation
DC1	<p>Check the door switch.</p> <ul style="list-style-type: none"> • Power the washer off. Wait 2-3 minutes, power the washer on, and then try again.
LC	<p>Check for water leaks.</p> <ul style="list-style-type: none"> • Power the washer off, and then check the drain system for any leaks. Once the leak issue is resolved, power the washer on. • Depending on the model, the drain system may drain water automatically. The Power and Start/Pause (Hold to Start) buttons may be disabled during this process
4C	<p>Check the water supply line.</p> <ul style="list-style-type: none"> • Check the connection to the water lines (including water taps). • Power the washer off. Wait 2-3 minutes, power the washer on, and then try again. • Depending on the model, the drain system may drain water automatically. The Power and Start/Pause (Hold to Start) buttons may be disabled during this process.
4C2	<p>Laundry needs protection because the water being supplied is too hot.</p> <ul style="list-style-type: none"> • Make sure the cold and hot water taps are properly connected. • Power the washer off. Wait 2-3 minutes, power the washer on, and then try again.
5C	<p>Check the drain system.</p> <ul style="list-style-type: none"> • Make sure the drain filter is not clogged. • If the drain filter is clogged, clean the filter, and then restart the washer.
HC	<p>Check the washing heater.</p>



	<ul style="list-style-type: none"> • Power off the washer, and then contact a Samsung service center
UB	<p>Check the spinning process.</p> <ul style="list-style-type: none"> • The load may not be balanced inside the drum. Check the drum and make sure the load is balanced. • Press Start/Pause (Hold to Start) to resume operation or power the washer off, wait 2-3 minutes, power the washer on, and then try again.
8C, 8C1, 8C2	<p>Check the MEMS sensor.</p> <ul style="list-style-type: none"> • Power the washer off. Wait 2-3 minutes, power the washer on, and then try again
OC	<p>Water may overflow.</p> <ul style="list-style-type: none"> • Close the water valve and call for service.
3C	<p>Check the motor.</p> <ul style="list-style-type: none"> • Power the washer off. Wait 2-3 minutes, power the washer on, and then try again.
AC6	<p>Check the PBA communication status.</p> <ul style="list-style-type: none"> • Power the washer off. Wait 2-3 minutes, power the washer on, and then try again
9C1, 9C2	<p>The electronic control needs to be checked.</p> <ul style="list-style-type: none"> • Check if power is supplied properly. • If the information code remains, contact a Samsung service center.
SF	<p>System failed.</p> <ul style="list-style-type: none"> • Power off the washer, and then contact a Samsung service center





If any information code keeps appearing on the screen, contact a local Samsung service center.

Specifications



Fabric care chart

The following symbols provide garment care direction. The clothing care labels include symbols for drying, bleaching, drying and ironing, or dry cleaning when necessary. The use of symbols ensures consistency among garment manufacturers of domestic and imported items. Follow care label directions to optimize garment life and reduce laundering problems.

Wash cycle



	Normal
	Permanent press/Wrinkle resistant/ Wrinkle control
	Gentle/Delicates
	Hand wash

Water temperature



	Hot
	Warm
	Cold

NOTE: The temperature range for Hot is 135 °F (57 °C) or below, 95 °F (35 °C) or below for Warm, and 68 °F (20 °C) or below for Cold. Wash water temperature must be a minimum of 60 °F (16 °C) for detergent activation and effective cleaning.

Bleach

	Any bleach (when needed)
	Only non-chlorine (color-safe) bleach (when needed)
	Tumble dry





Normal

	Permanent press/Wrinkle resistant/ Wrinkle control
	Gentle/Delicates



Special instructions

	Line dry/Hang to dry
	Drip dry
	Dry flat







Heat setting

	High
	Medium
	Low
	Any heat
	No heat / Air





Iron dry or steam temperatures

	High
	Medium
	Low

Warning symbols for laundering

	Do not wash
	Do not wring
	Do not bleach
	Do not tumble dry
	No steam (added to iron)
	Do not iron

Dry-clean

	Dry-clean
	Do not dry-clean
	Line dry/Hang to dry
	Drip dry
	Dry flat

Protecting the environment

- This appliance is manufactured from recyclable materials. If you decide to dispose of it, please observe local waste disposal regulations. Cut off the power cord so that the appliance cannot be connected to a power source. Remove the lid so that animals and small children cannot get trapped inside the appliance.
- Do not exceed the detergent quantities recommended in the detergent manufacturers' instructions.
- Use stain removal products and bleaches before the wash cycle only when necessary.
- Save water and electricity by only washing full loads (the exact amount depends upon the program used).

Declaration of conformity

This appliance complies with UL2157.

Specification sheet

Type		Front loading washer	
		WF45B6300A*	
Capacity (Cu.ft)		4.5	
Water pressure (psi (kPa))		20-116 (137-800)	
NETweight (lb (kg))		201 (91.0)	
Spin revolution		1200 rpm	
Heating Rating		900 W	
Power consumption	Washing	120 V	200 W
	Washing and Heating		1150 W
	Spin		550 W
	Drain		80 W

Warning

This content is compiled from multiple sources and is provided for reference purposes only. It may not be complete or fully applicable to all situations. If you are unable to resolve your issue, please contact the product manufacturer or an authorized service provider for official support.