

Quick Start Guide For DVR System

Description of Panels

Front Panel

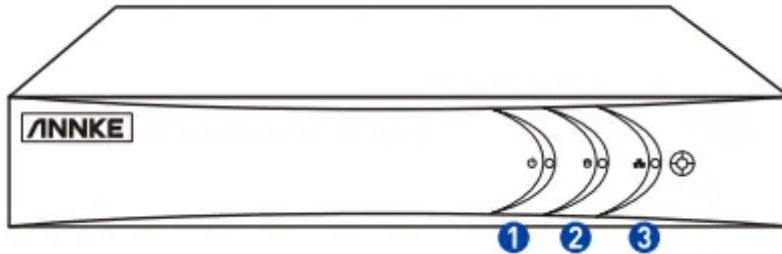

1. Power LED: Turns yellow when DVR is powered up.
2. HDD LED: Turns red when data is being read from or written to HDD.
3. Network LED: Turn yellow when network is connected.

Real Panel

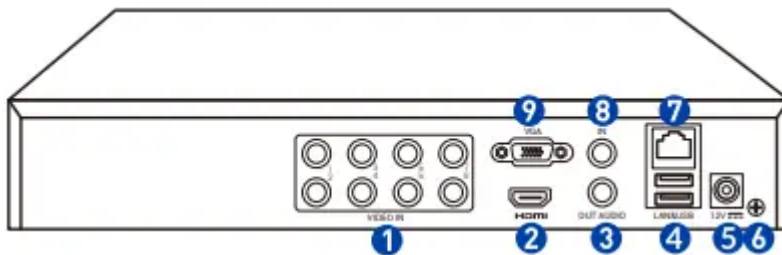

1. VIDEO IN: BNC interface for TVI and other analog video input.
2. HDMI: HDMI video output connector.
3. AUDIO OUT: RCA connector for audio output
4. USB Port: USB port for mouse, USB drive and other additional devices.
5. Power Supply: 12V DC power supply
6. GND: Ground(needs to be connected when NVR starts up).
7. Network Interface: Connector for network
8. AUDIO IN: RCA connector for audio input
9. VGA: VGA video output connector.

Important reminder

- You can record and play back only after the hard disk is installed. Otherwise, you can only preview. *Make sure that the plug is firmly connected to the power socket.

- Do not drop the camera or subject it to physical shock to avoid damage.
- Do not touch the lens of camera with fingers. If cleaning is necessary, use clean cloth with a bit of ethanol and wipe it gently.
- Do not place the camera in extremely hot, cold(the operating temperature shall be -40°C to 60°C), dusty or damp locations, and do not expose it to high electromagnetic radiation.
- The recommended installation height of the camera is more than 2 meters.
- In the scope of camera monitoring, it should try to avoid large areas of all black objects, open spaces, water and other objects that absorb infrared light, otherwise the night vision effect will be reduced.
- The installation angle of the camera is very important. Do not obstruct the edges of the image, as this will result in poor image quality, and do not aim the camera at the sun or other extra bright places.



A: Connect your Camera to the video cable

Connect Camera's BNC female and DC male port to the video cable's BNC male and DC female port.

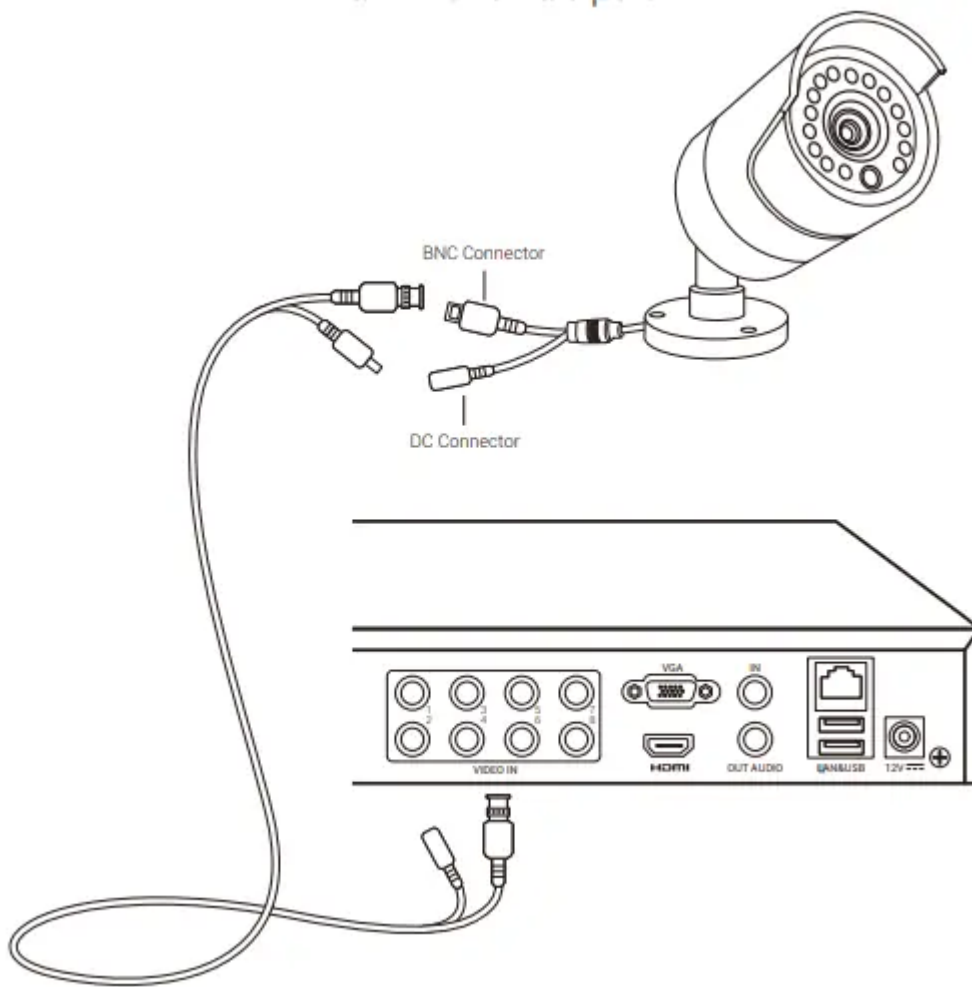

Connect the video cable's BNC port to the DVR's BNC video in port.

B: Connect the video cable to the DVR.

C: Connect the video cable to the 1 to 4 power splitter cable



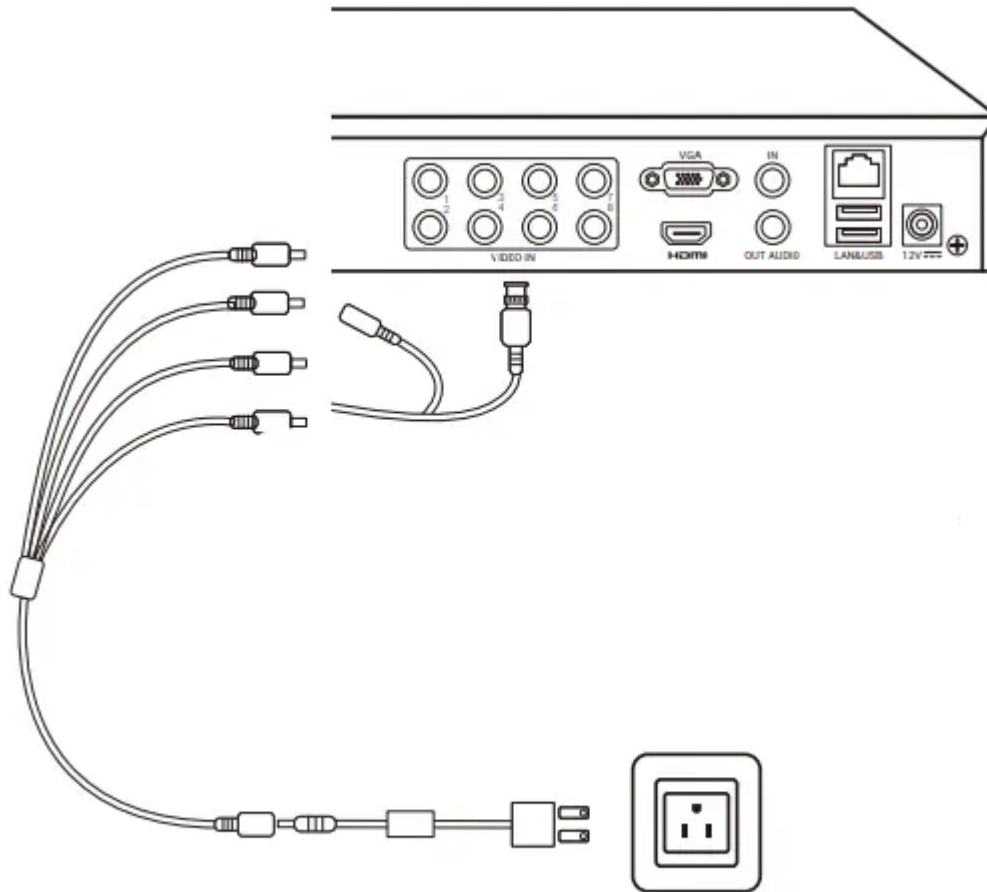

Connect the video cable's DC port to the 1 to 4 power splitter cable's DC female port.

Connect the 1 to 4 power splitter cable's DC Male port to the camera's power DC port.

D: Connect the 1 to 4 power splitter cable to the camera's power.

E: Connect your DVR to a HD TV/monitor.

Connect your DVR to a HD TV/monitor via a HDMI or VGA cable for live view

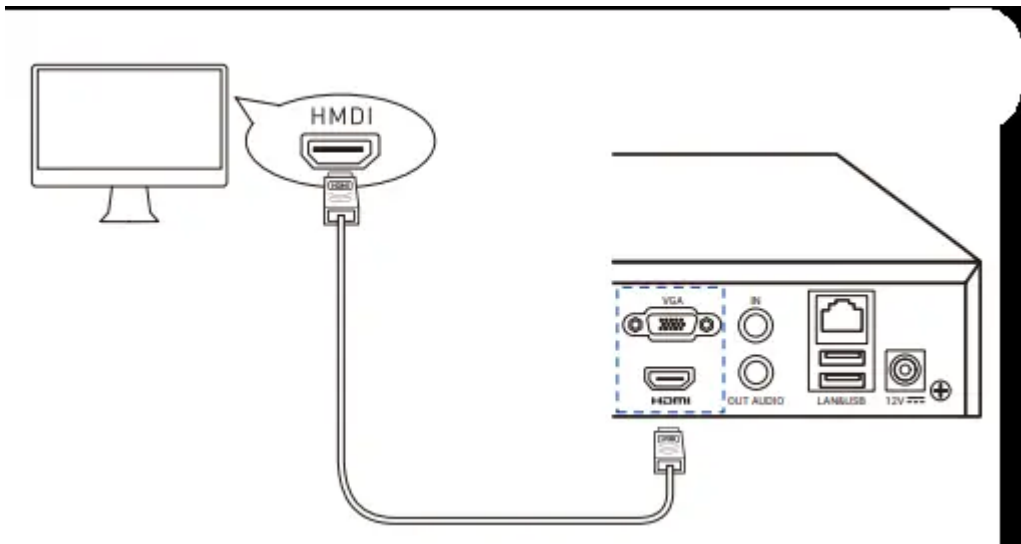

F: Connect your DVR to the router

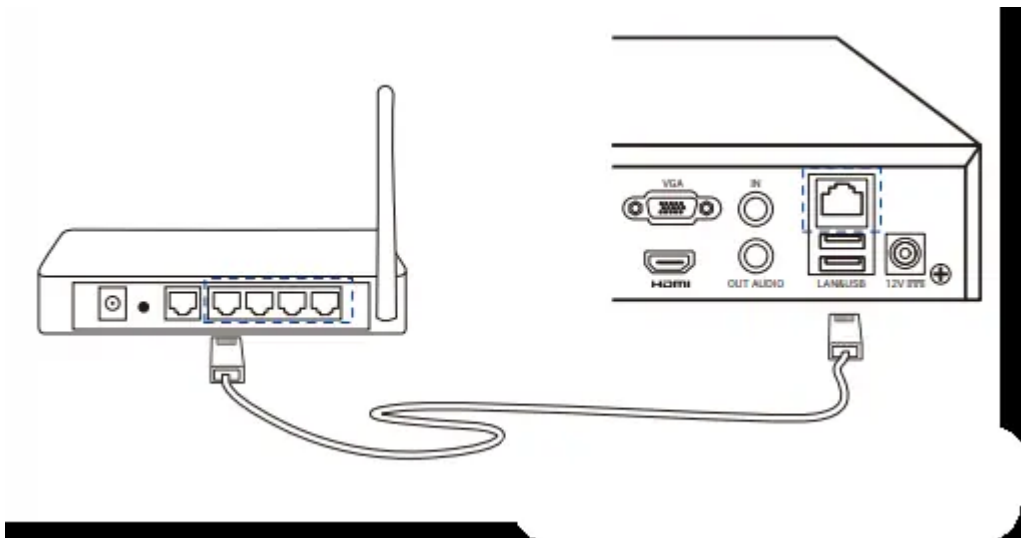

Connect your DVR's RJ-45 port to the router's LAN by network cable (Not included) for remote view.

G: Connect the mouse to the DVR

Connect the mouse's USB port to the DVR's USB port.

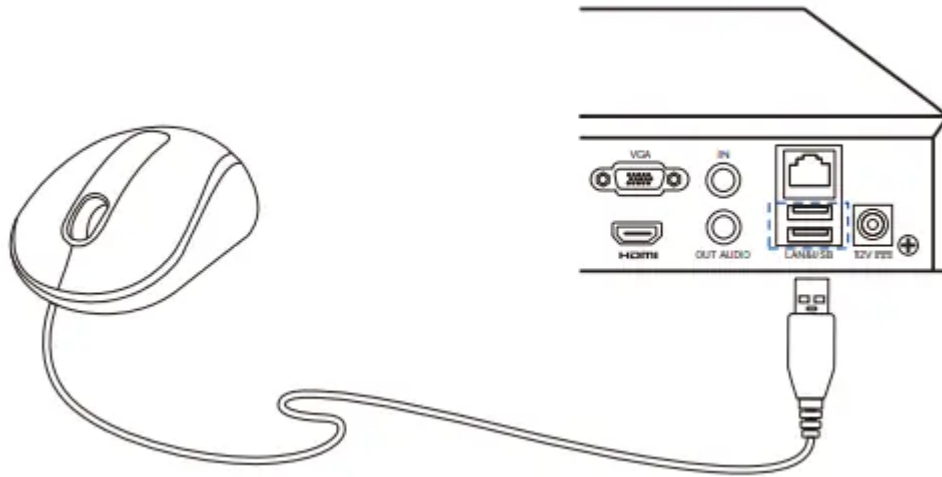

H: Connect the DVR's power adapter

Connect the DVR's power adapter to the DVR's 12V input port.

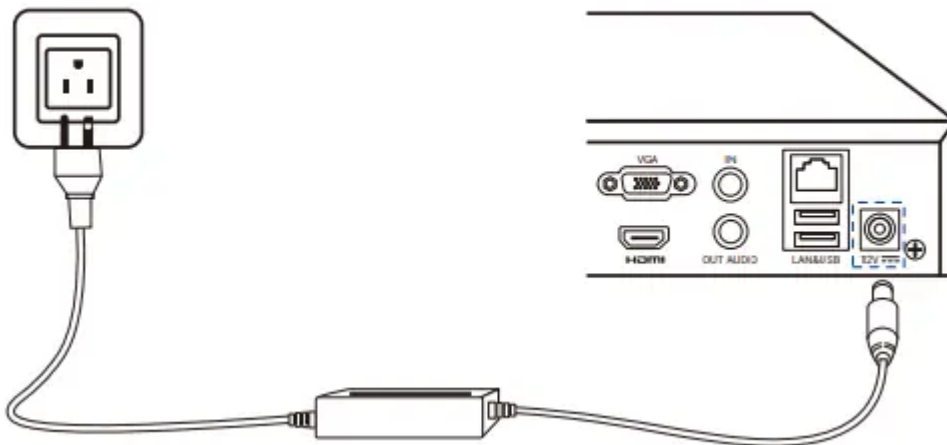

I: Test the camera

We recommend that you test the camera locally before fixing the camera.



J: Install the camera

Install the camera to the desired location, please disconnect the power before installation.

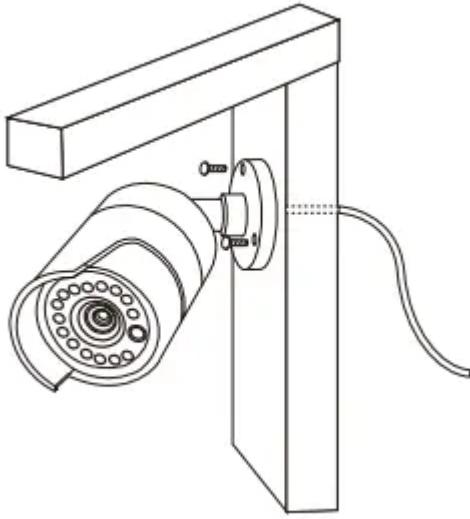

Connection Diagram

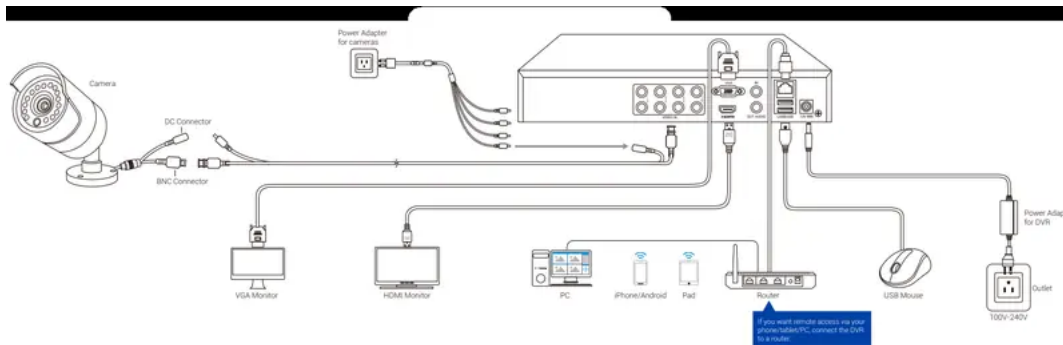

System setup

We suggest you follow the wizard to set you DVR, finished it step by step.

Wizard setup:

1. Create your password
2. Set Reserved E-mail, back up GUID file,
3. Set unlock pattern, security question
4. Setting signal input status
5. Choose system language
6. Configure time zone
7. Configure the IP Address and P2P function

8. Configure Port and other settings

A: Create your password

For the first-time access, you need to activate the device by setting an admin password. Input your password three times to create it. And we recommend you reset your password monthly to protect your product better.

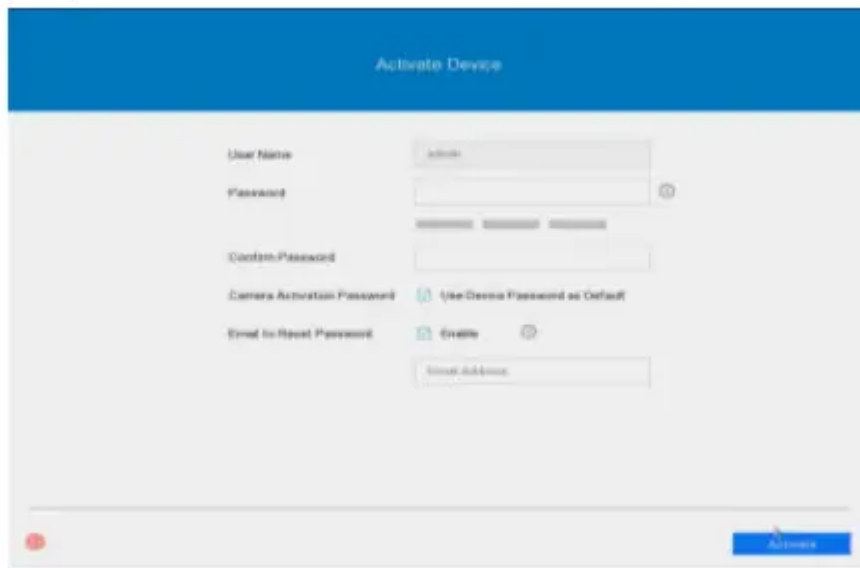

The screenshot shows the 'Activate Device' web interface. It features a blue header with the title 'Activate Device'. Below the header, there are several input fields and checkboxes:

- User Name:** A text input field containing the text 'Admin'.
- Password:** A text input field with a strength indicator icon to its right.
- Confirm Password:** A text input field.
- Camera Activation Password:** A checkbox labeled 'Use Device Password as Default' which is checked.
- Email to Reset Password:** A checkbox labeled 'Enable' which is checked, and a text input field for 'Email Address' below it.

At the bottom right of the form, there is a blue button labeled 'Activate'.

B: Set the P2P function

You need to manually create a verification code, which consists of 6 to 12 digits or letters, and then confirm it (ABCDEF is not allowed). Download our free APP Annke Vision, then follow the APP prompt to scan the SN QR code to add device step by step. The device can be successfully added only if the P2P's status is online. You can also go to Main Menu - Configuration- Network Settings - Platform Settings to scan and add the device.

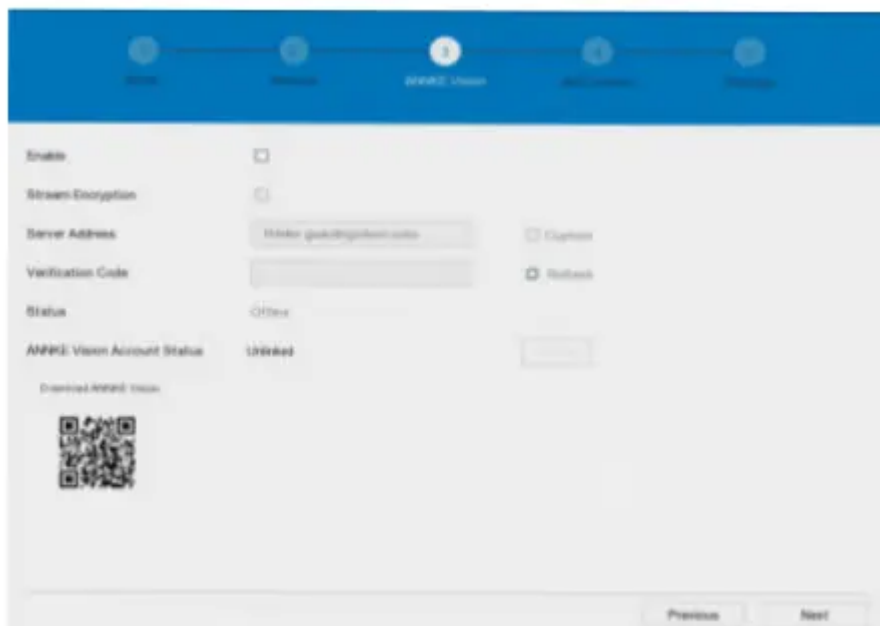

The screenshot shows the P2P function configuration web interface. It features a blue header with a progress indicator showing five steps: 1. P2P, 2. P2P, 3. P2P (selected), 4. P2P, 5. P2P. Below the header, there are several settings:

- Enable:** A checkbox which is checked.
- Stream Encryption:** A checkbox which is unchecked.
- Server Address:** A text input field containing 'http://gskdipin.com' and a checkbox labeled 'Custom' which is unchecked.
- Verification Code:** A text input field and a checkbox labeled 'Default' which is checked.
- Status:** A dropdown menu showing 'Offline'.
- ANNKE Vision Account Status:** A text input field containing '1234567'.

Below the settings, there is a section titled 'Download ANNKE Vision' with a QR code. At the bottom right, there are 'Previous' and 'Next' buttons.

C: VGA/HDMI Output Resolution Adjust

Default DVR output resolution is 1024*768. For better viewing, please adjust the DVR output resolution to a higher level if your monitor support.

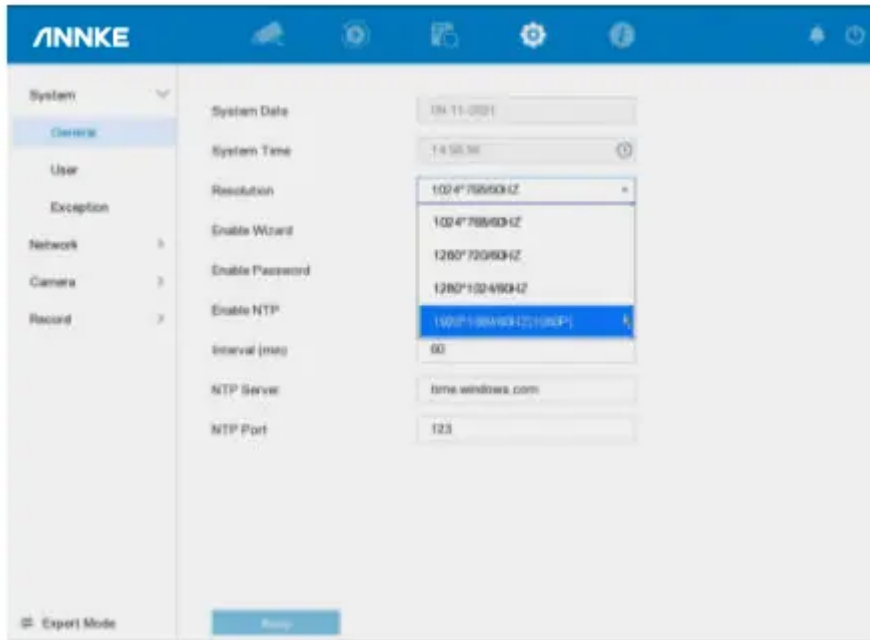

D: Menu Structure

The interface may be different between different models and different software versions. B: Set the P2P function

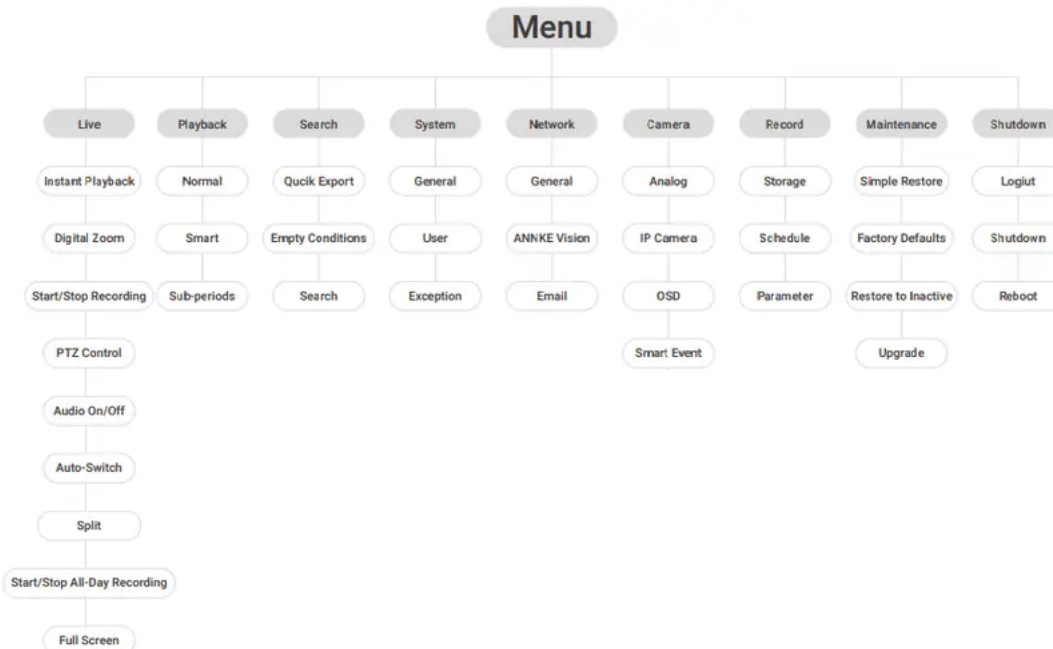

Remote Control

A: Connect DVR to internet



Connect your DVR to your router by a network cable, go to Menu > Configuration > Network > Platform Access , make sure the status of P2P shows Online.

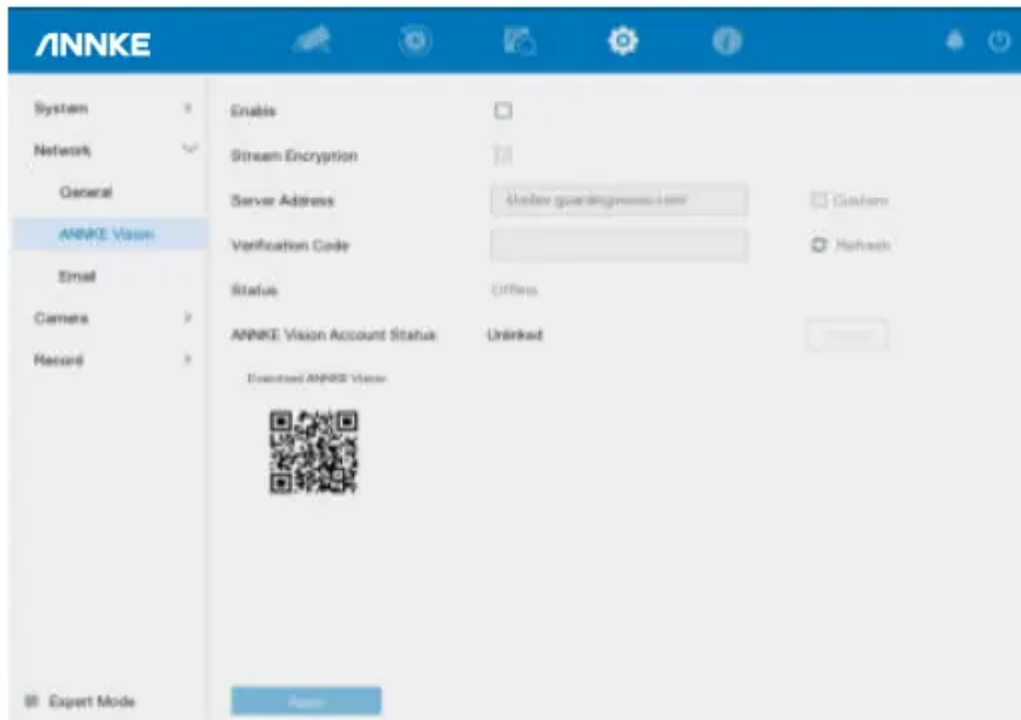

B: Install Annke Vision APP

Download our free Annke Vision APP from Google Play or Apple Store, or just scan the QR code below to download the app .



Android





IOS









After install the app, select the correct country or region where your device located, and click Register to sign up for an account by your mobile phone number or email address.

C: Add device

Select “” or click the icon “” in the upper right corner to add a device. You can go to Menu > Configuration > Network > Platform Access interface to scan the SN QR code, follow the hint and finish it.



-  Playback
-  Device search
-  Add Device
-  Device list
-  Alarm Push
-  More APP setting





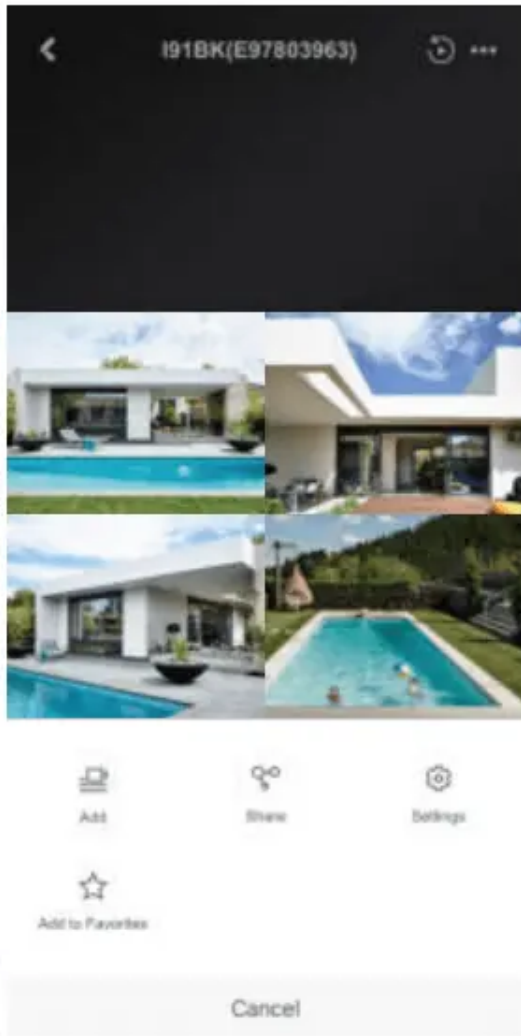
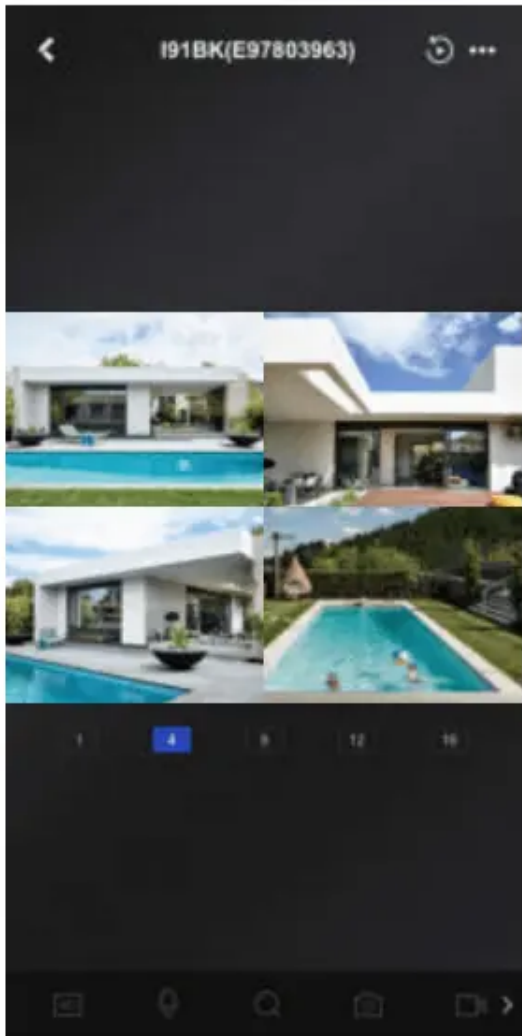

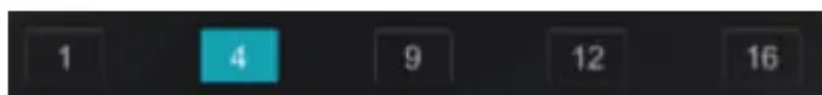

D: Live view and playback

Click Device name to start live view , you can also playback the video , share device and do other operates.





Window division mode

-  Live view quality adjust
-  Start the selected live view windows
-  Stop the selected live view windows
-  Turn audio on
-  Turn audio off
-  Digital zoom
-  Capture
-  More setting

If you have any question, Please go to help.annke.com first and submit a request to the support team. We will give you a satisfactory solution soon!

Warning

This content is compiled from multiple sources and is provided for reference purposes only. It may not be complete or fully applicable to all situations. If you are unable to resolve your issue, please contact the product manufacturer or an authorized service provider for official support.