

Models: AC-RBF4-B, AC-RBF4-W, AC-RBF42-B, AC-RBF42-W, AC-RBF6-B, AC-RBF6-W, AC-RBF62-B, AC-RBF62-W

## KEY FEATURES

**ALUMINIUM FRAME** Features an aluminum frame with CNC-machined corners and a white or bronze finish to give cabinets a clean look.

**SMART CONTROLLER** Enables temperature monitoring. hot and cold temperature triggers. and fan speed control.

**STATOR BLADES** Hydro-mechanical stator blades enable air to travel farther even in high static pressure environments.

**QUIET PWM MOTOR** PWM-controlled motor features precise speed control. reduced noise. and energy-efficient DC power.

**PROTECTIVE BACK** Enclosed in a thermoplastic casing with fan guards to protect users from high speed fans and prevent clogging.

**DUAL BALL BEARINGS** Enables unit to be mounted in any direction. Motor contains dual-ball bearings with a 67.000 hours lifespan.

**ALUMINIUM FRAME**

Features an aluminum frame with CNC-machined corners and a white or bronze finish to give cabinets a clean look.

**SMART CONTROLLER**

Enables temperature monitoring, hot and cold temperature triggers, and fan speed control.

**DUAL BALL BEARINGS**

Enables unit to be mounted in any direction. Motor contains dual-ball bearings with a 67,000 hours lifespan.

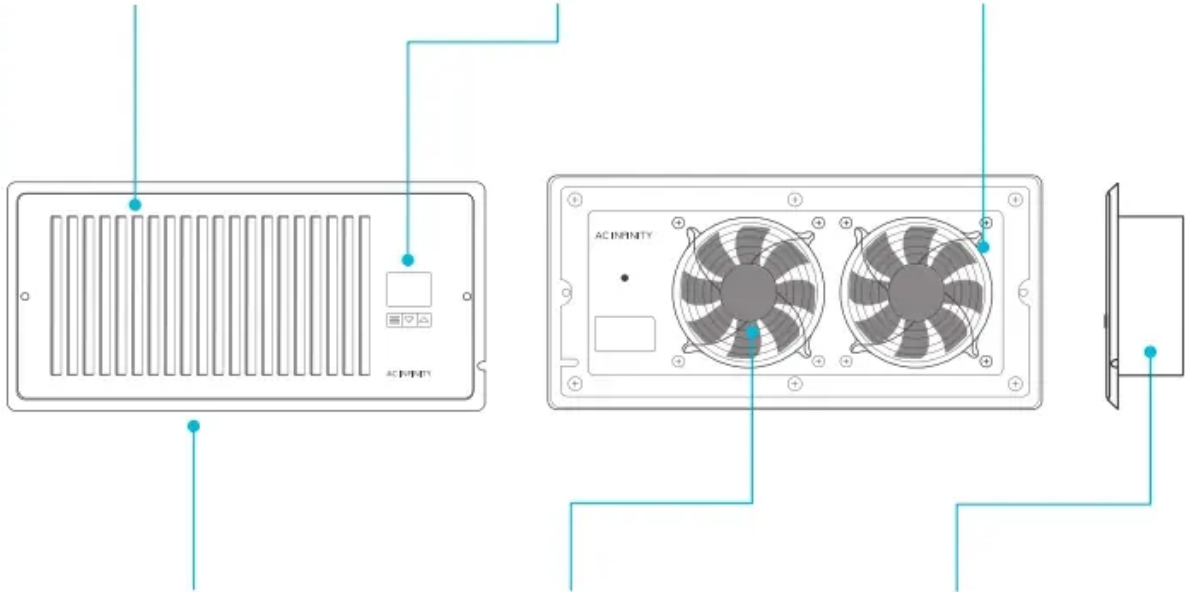

**QUIET PWM MOTOR**

PWM-controlled motor features precise speed control, reduced noise, and energy-efficient DC power.

**STATOR BLADES**

Hydro-mechanical stator blades enable air to travel farther even in high static pressure environments.

**PROTECTIVE BACK**

Enclosed in a thermoplastic casing with fan guards to protect users from high speed fans and prevent clogging.

**PRODUCT CONTENTS**

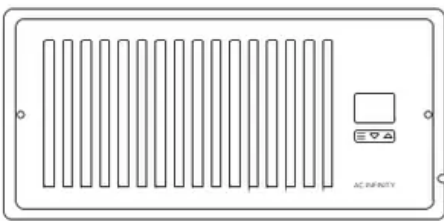

REGISTER FAN (x1)

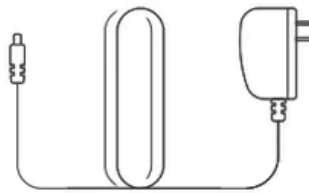

POWER ADAPTER (x1)



SCREW SET (x2)

**INSTALLATION**

**STEP 1:**

Measure your register vent to make sure this model will fit. Standard sizes come in 4x10”.



4x12". 6x10". 6x12" etc.

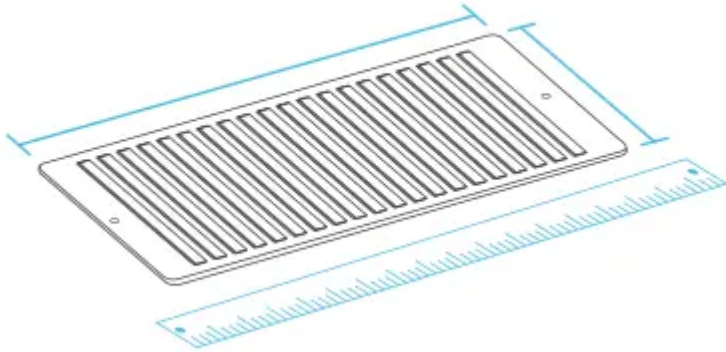

**STEP 2:**

Remove your register grille. You may need to use a Philips screwdriver to remove the mounting screws.

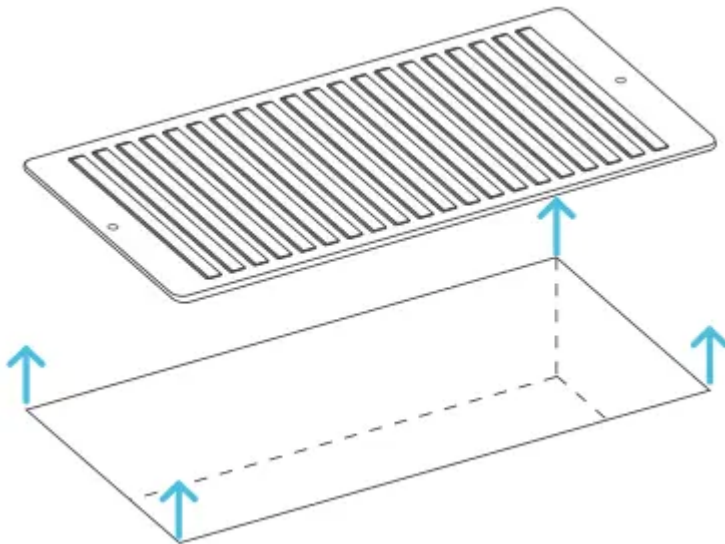

**STEP 3:**

Plug the power adapter into an outlet. This can be next to your register or inside your register.



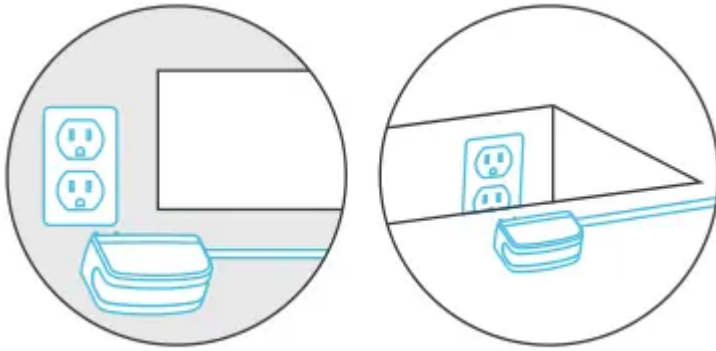

STEP 3.5:

If you are powering the register fan with an external outlet, run the power cord towards the groove on the side of the register fan.

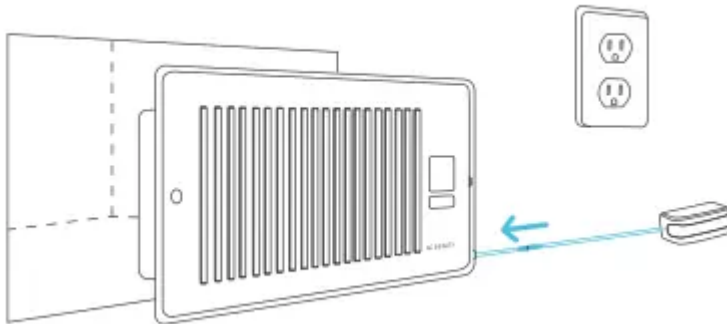

STEP 4:

Plug the power adapter's cord into the power receptacle of the register fan unit.

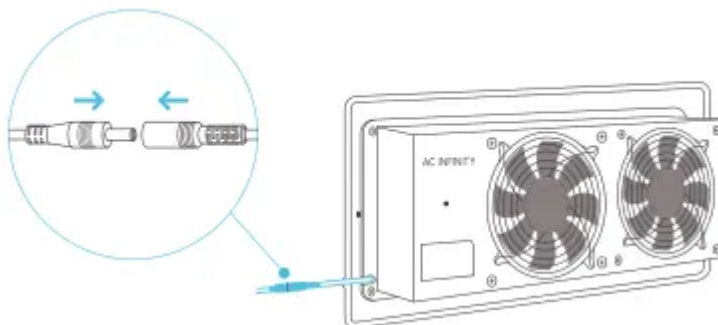

STEP 5:

Check the LCD display to see if it is lit and shows a number reading.



STEP 6:

Position the register fan to be mounted.

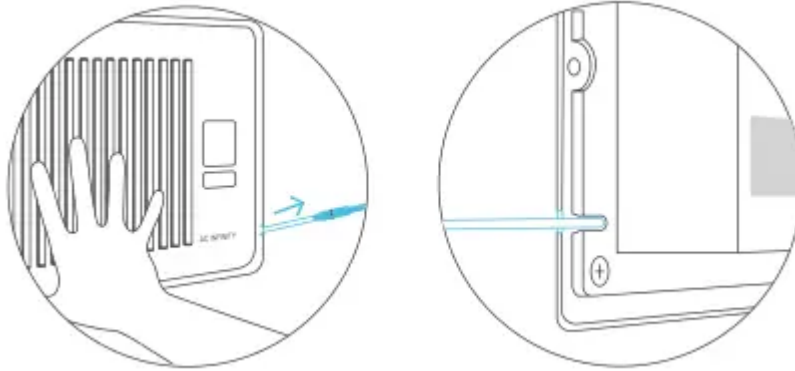

If the outlet is external, make sure the cord runs through the gap between the wall and mounting plate.

STEP 7:

Drill your existing screws into the mounting holes to secure the register fan. If needed, use the screws included with your register fan.

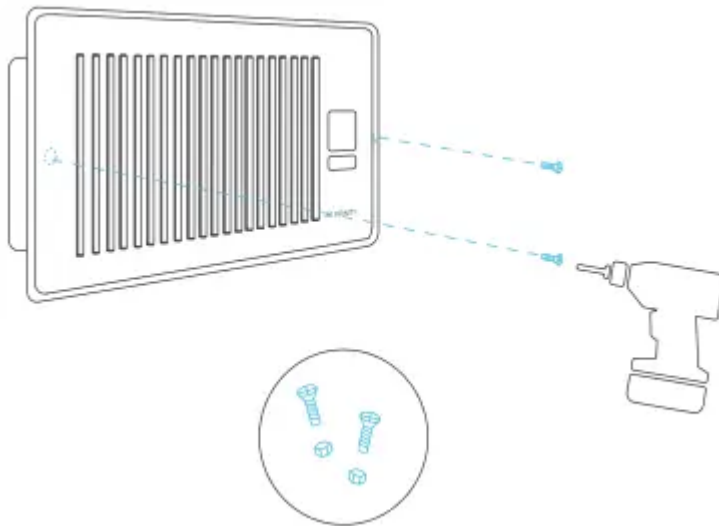

If the screw holes do not align, you may need to drill new holes into your wall.

## PROGRAMMING

1. **MODE BUTTON** Cycles through the unit's modes: temperature display, cooling trigger, heat trigger, and fan speed.
2. **UP / DOWN BUTTON** Changes the temperature setting in the cooling trigger, the heating trigger, and the fan speed.
3. **TEMPERATURE DISPLAY** Displays the current temperature that is measured by the probe. Used as the default display.



4. **COOLING TRIGGER** Allows you to set a temperature trigger for the fans to run when your air conditioner system is on.

5. HEATING TRIGGER Allows you to set a temperature trigger for the fans to run when your central heating system is on.

6. FAN SPEED Sets the fans' maximum running speed when the cooling or heating triggers are tripped to run.

### **IMPORTANT NOTES – PLEASE READ**

This product is used to boost your existing AC or heater's airflow. It allows you to set temperature points where the fans will turn on if the airflow's temperature falls below or rises above the cooling or heating trigger's setting, respectively.

This product has 10 fan speeds from 1-10. Use the fan speed setting to set your desired airflow boosting. Keep in mind the faster the fans spin, the louder they will be.

We've designed the fans to ramp up or down, instead of quickly turning on or shutting down to minimize noise and power consumption.

When not changing settings, we recommend staying on the temperature display mode to monitor and accurately gauge your airflow's temperature. Do not use your AC or heater's thermostat reading; it does NOT display the airflow's temperature.

### **TEMPERATURE DISPLAY**

This mode displays the airflow temperature measured by the probe. While on this display mode, the cooling and heating triggers, as well as the max fan speed setting, are still active unless you disabled them.



### **CONTROLLER LOCK**

To lock the controller, go to the temperature display mode and then hold the mode button for three or more seconds.

While the display is locked, you will not be able to switch modes or adjust settings, but they will be working in the background. Holding the mode button for three or more seconds will unlock the controller.

NOTE: Only In Temperature Display Mode. holding the mode button will cause the display to lock!



### HIDE DISPLAY

While the controller is locked, you can hide the display and turn off its backlight by pressing the mode button.

All programs and settings will still be working in the background while the display is hidden. Press any button to show the display again.



### COOLING TRIGGER

Use this mode to set the temperature trigger for your air conditioner. Please note you are NOT setting your desired temperature.

In this mode, the fans will run if the probe temperature meets or falls below the trigger's cold temperature setting. It will not run if the probe temperature is above the trigger's cold temperature setting.

Press the up or down buttons to set the cooling trigger temperature. To calibrate your register booster fans, turn on your AC and wait for a few minutes until the probe temperature stabilizes. Set your cooling trigger to this number or higher.

To avoid confusion, we recommend disabling the cooling trigger when not using your AC. To disable it, hold the mode button for two seconds. The display will show OF. We also recommend returning to the temperature display mode once you finish adjusting your cooling trigger.



If the AC is turned off, the probe will detect a higher temperature than your Cooling Trigger, telling the fans to turn off.

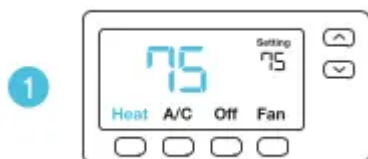

Your air conditioner turns on.

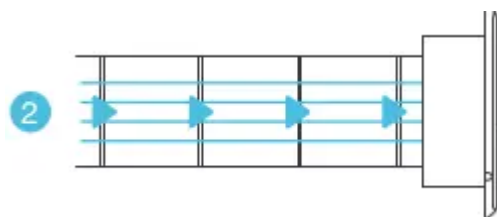

Cold air blows through the duct and into your room.

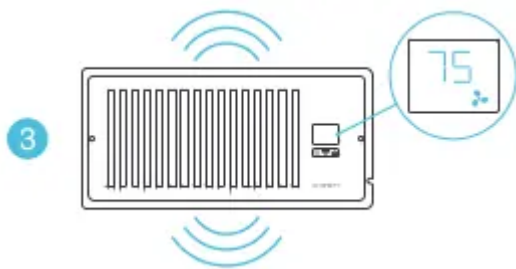

When the probe detects the airflow temperature has fallen below your Cooling Trigger, it will activate the fans.

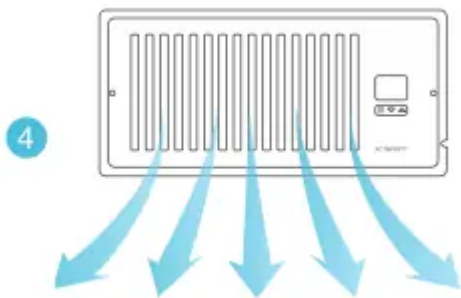

The fans will pull cold air from your duct to boost your AC output

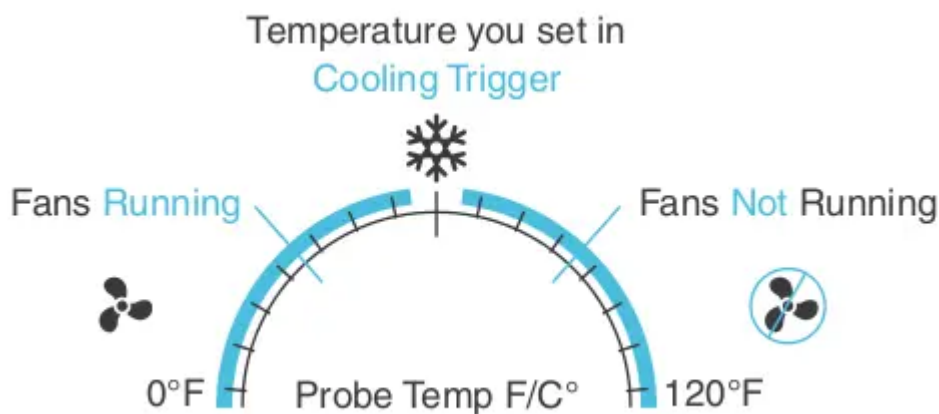

## HEATING TRIGGER

Use this mode to set the temperature trigger for your heater. Please note you are NOT setting your desired temperature.

In this mode, the fans will run if the probe temperature meets or rises above the trigger's hot temperature setting. It will not run if the probe temperature is below the trigger's hot temperature setting.

Press the up or down buttons to set the heating trigger temperature.

To calibrate your register booster fans, turn on your heater and wait for a few minutes until the probe temperature stabilizes. Set your heating trigger to this number or lower.

To avoid confusion, we recommend disabling the heating trigger when not using your heater. To disable it, hold the mode button for two seconds. The display will show OF. We also recommend returning to the temperature display mode once you finish adjusting your heating trigger.



If the heater is turned off, the probe will detect a lower temperature than your Heating Trigger, telling the fans to turn off.



Your central heating system turns on

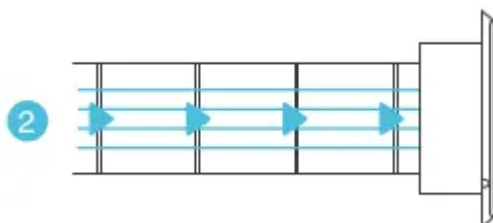

Heated air blows through the duct and into your room.

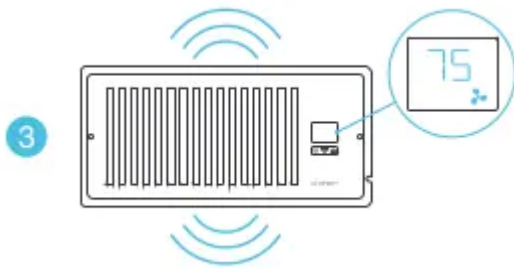

When the probe detects the airflow temperature has risen above your Heating Trigger, it will activate the fans

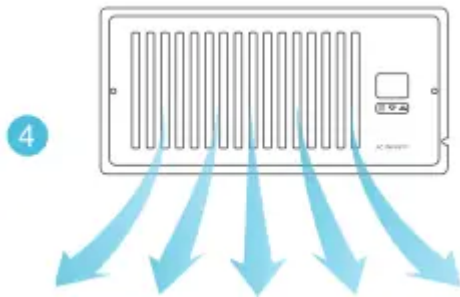

The fans will pull heated air from your duct to boost your heater output.

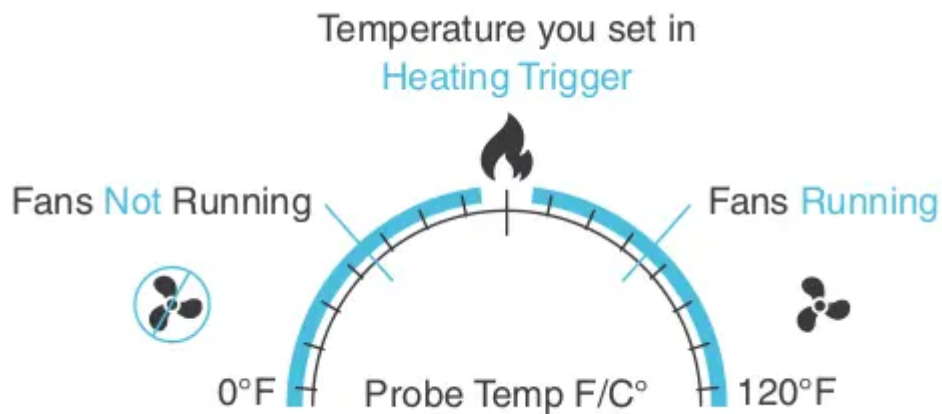

## FAN SPEED

This mode allows you to set a maximum fan speed in which they will actively run until you leave it. Pressing up or down will change the fan speed and determine the level of airflow boosting. Holding the MODE button will set the fan speed to 0.

Keep in mind the faster the fans spin. the louder they will be.

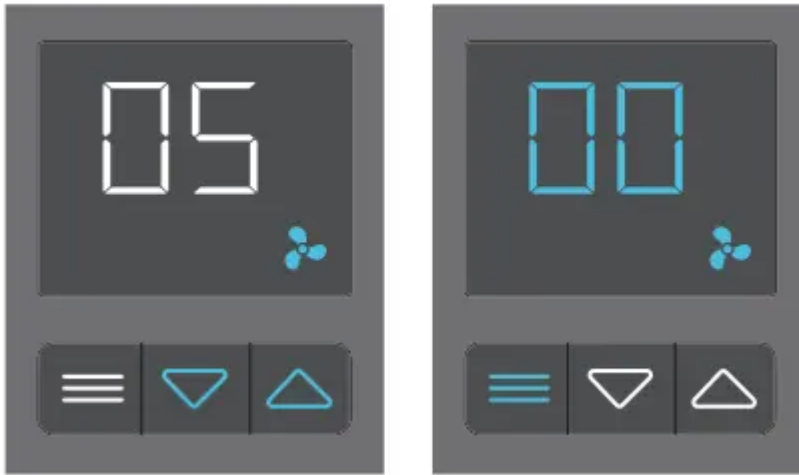

## FAHRENHEIT OR CELSIUS

To change the temperature scale between Fahrenheit and Celsius, hold the up and down buttons simultaneously until the letters change. All digits displayed will be automatically converted to the designated scale.

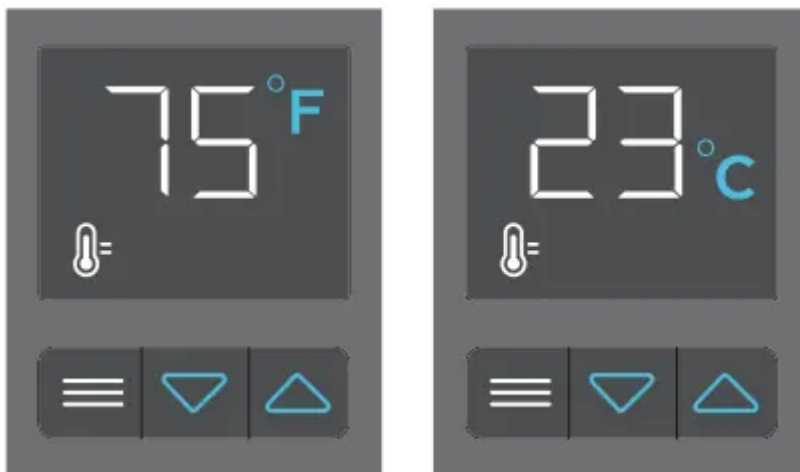

## AIRTAP FAQ

Q: Will I be able to mount this fan on my ceiling?

A: For safety reasons, we do not recommend mounting the AIRTAP on your ceiling.

Q: Will I be able to mount this fan on a baseboard style register?

A: No. Because of the tilted design, the AIRTAP will not have the clearance to be properly mounted.

Q: My register is bigger than my fan's rear insert. How can I fit this fan onto my register?

A: We can only recommend using the appropriately sized AIRTAP fan for your register. Contact customer service for fitment issues.

Q: Does this register booster fan have fittings to use a filter with?

A: This product is not specifically designed to be used with filters.

Q: Can I reverse this fan's airflow?

A: The AIRTAP's boosted airflow cannot be reversed. nor can the fans be flipped.

Q: What temperature is the register booster fan detecting?

A: The AIRTAP's backside probe reads the airflow temperature of your register vent. Please note this temperature may vary from your home thermostat's reading.

Q: My register booster fan is too loud. How do I decrease the fan noise?

A: To minimize the noise coming from the AIRTAP. decrease the maximum fan speed. Refer to page 19.

Q: My fan is constantly running when I don't need it to. How do I turn it off?

A: The heating and cooling triggers may be active at the same time. Disable the trigger you are not using by holding the mode button until the screen displays OF.

## AC INFINITY PRODUCTS

### RACK FANS The CLOUDPLATE

Series rack fan system is designed for quietly cooling a wide range of audio. video. home theater. network. and IT equipments racks. The model features a thermal controller with intelligent programming that will automatically adjust the fan speeds in response to changing temperatures.



### DUCT FANS The CLOUDLINE

Series is a line of duct fans designed to quietly ventilate AV rooms and closets. as well as various DIY air circulation and exhaust projects. Features a thermal controller with intelligent programming that will automatically adjust duct fan speeds in response to changing temperatures.



### PROJECT MUFFIN FANS The AXIAL

Series fan kit is designed for various DIY projects that requires cooling or ventilation; or as a replacement fan for many products on the market. Each fan kit includes fan guards and everything needed to mount the unit onto a wall and power it through a wall outlet. S-series models include a speed controller.

Discover the latest innovations in cooling and ventilation at [acinfinity.com](http://acinfinity.com)

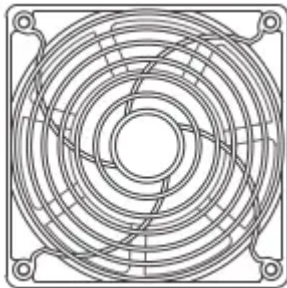

## WARRANTY

If you have any issues with this product. contact us and we'll happily resolve your problem or issue a full refund!

This warranty program is our commitment to you. the product sold by AC Infinity will be free from defects in manufacturing for a period of two years from the date of purchase. If a product is found to have a defect in material or workmanship. we will take the appropriate actions defined in this warranty to resolve any issues.

The warranty program applies to any order. purchase. receipt. or use of any products sold by AC Infinity or our authorized dealerships. The program covers products that have become defective. malfunctioned. or expressively if the product becomes unusable. The warranty program goes into effect on the date of purchase. The program will expire two years from the date of purchase. If your product becomes defective during that period. AC Infinity will replace your product with a new one or issue you a full refund.

The warranty program does not cover abuse or misuse. This includes physical damage. submersion of the product in water. incorrect Installation such as wrong voltage input. and misuse for any reason other than intended purposes. AC Infinity is not responsible for consequential loss or incidental damages of any nature caused by the product. We will not warrant damage from normal wear such as scratches and dings.

To initiate a product warranty claim. please contact our customer service team at [support@acinfinity.com](mailto:support@acinfinity.com)

### Warning

This content is compiled from multiple sources and is provided for reference purposes only. It may not be complete or fully applicable to all situations. If you are unable to resolve your issue, please contact the product manufacturer or an authorized service provider for official support.

---

Document generated by [ManualsFile](#)