

CONTROL PANEL AND FEATURES

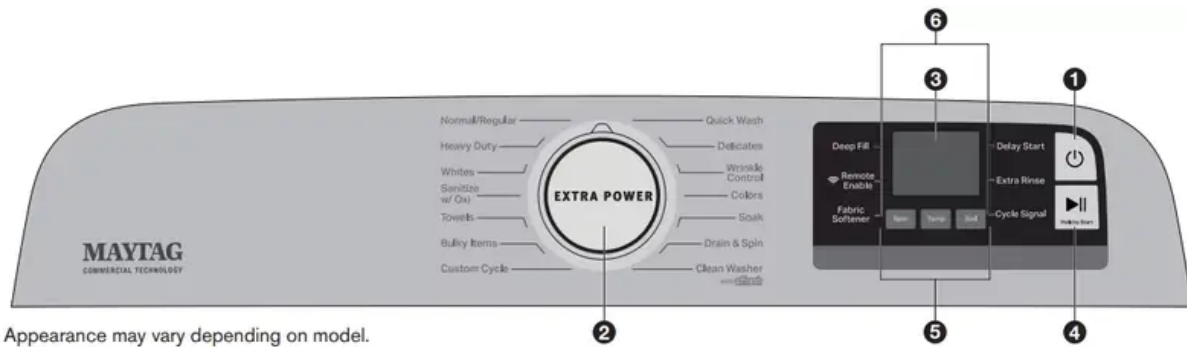

Appearance may vary depending on model.

Appearance may vary depending on model.

1. POWER

POWER Touch to turn on/off or to stop/cancel a cycle.

2. CYCLE KNOB

Turn knob to select desired cycle.

EXTRA POWER

Press to boost stain fighting on selected cycle.

3. DISPLAY LCD

The display shows the time required for the cycle to complete. Factors such as load size and water pressure may affect the time shown in the display. Tightly packed loads, unbalanced loads, or excessive suds may cause the washer to adjust cycle time as well.

ADD GARMENT

When Add Garment is lit, you may open the lid, which automatically pauses the cycle, and add items. To resume, close the lid and hold the START/PAUSE button to start the washer again.

4. START/PAUSE

Touch and hold the START/PAUSE button to start cycle. Touch during a cycle to pause cycle and unlock lid. NOTE: If machine is spinning it may take longer to unlock lid.

5. CYCLE MODIFIERS (Not all modifiers are available on all cycles)

SPIN

Touch to modify the cycle's available spin speeds (Off, Medium, Fast).

TEMP

Touch to modify the cycle's available temperatures (Tap Cold, Cold, Cool, Warm, Hot).

SOIL

Touch to modify the cycle's available soil levels. Increase soil level for heavily soiled items and decrease soil level for lightly soiled items (Extra Light, Light, Normal, Heavy, Extra Heavy).

6. **CYCLE OPTIONS** (Not all options are available on all cycles).

DEEP FILL

Touch to add more water to the washer from the cycle's auto sensed level (Auto, Medium, High, Max Fill).

REMOTE ENABLE

Touch each time you want to remotely control via the Maytag™ app. Follow the instructions in the "GET THE MAYTAG™ APP AND GET CONNECTED" section below for more details. Opening the lid cancels "Remote Enable".

FABRIC SOFTENER

Touch to let the machine know when you have added fabric softener to the dispenser drawer.

DELAY START

Touch to delay the start of the wash cycle for up to 12 hours.

EXTRA RINSE

Touch to automatically add a second rinse available on most cycles.

CYCLE SIGNAL

Touch to turn the end of cycle signal on/off and adjust the tone volume when a button is touched.

Warning! Fire Hazard

Never place items in the washer that are dampened with gasoline or other flammable fluids.

No washer can completely remove oil.

Do not dry anything that has ever had any type of oil on it (including cooking oils).

Doing so can result in death, explosion, or fire.

*NOTE: Not all cycles, settings or options are available with all models.

1. **SORT & LOAD LAUNDRY**

See Loading Recommendation section below.

2. **ADD HE DETERGENT & LAUNDRY PRODUCTS TO DISPENSERS***



Remove inside tray for powder HE detergent.



Follow manufacturer's instructions to determine amount of laundry products to use.



3. TOUCH POWER TO TURN ON THE WASHER



4. SELECT THE DESIRED CYCLE FOR YOUR LOAD*

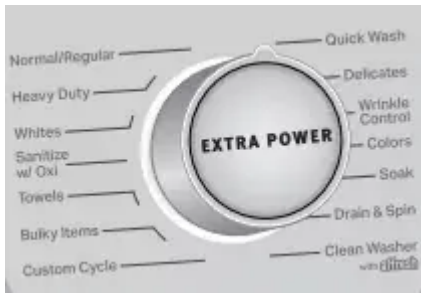

5. ADJUST CYCLE SETTINGS, IF DESIRED*



6. SELECT ADDITIONAL OPTIONS*



7. TOUCH AND HOLD START/PAUSE TO BEGIN CYCLE

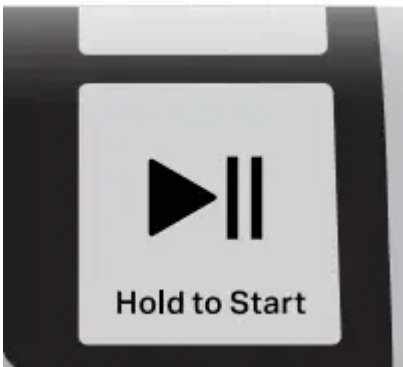

Loading Recommendation

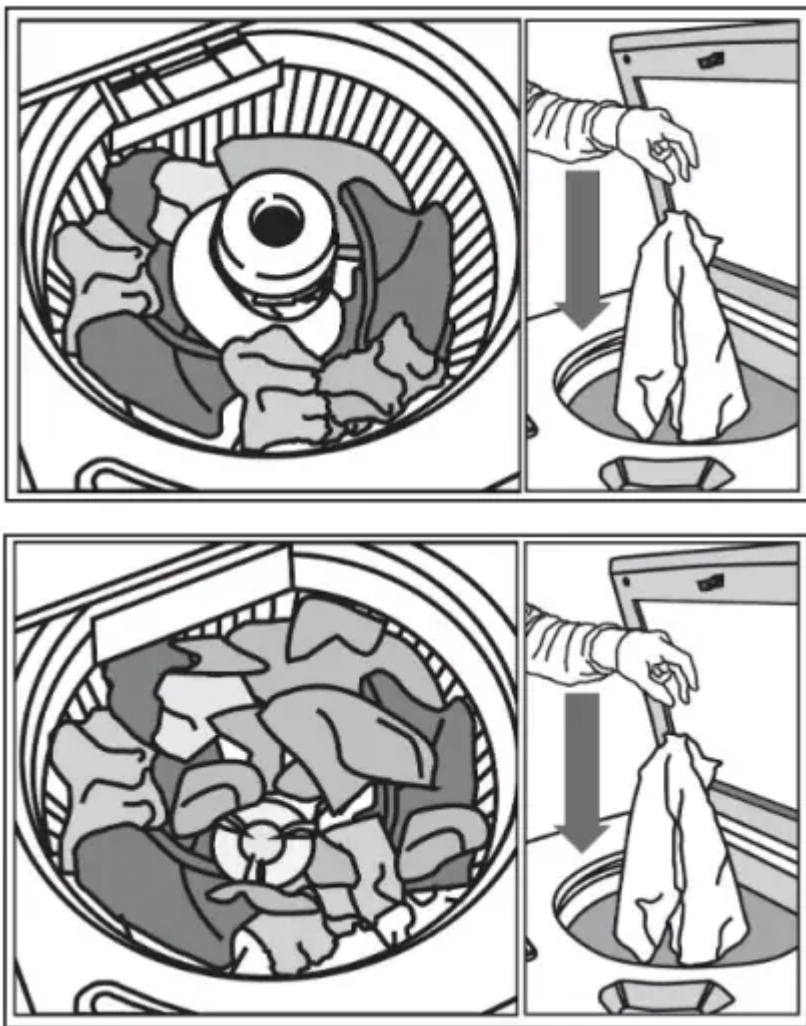

For best performance, it is recommended to load items by dropping them in loose heaps evenly around the washplate and agitator. Do not lay items length-wise around the washplate or agitator.

More Water When You Want It

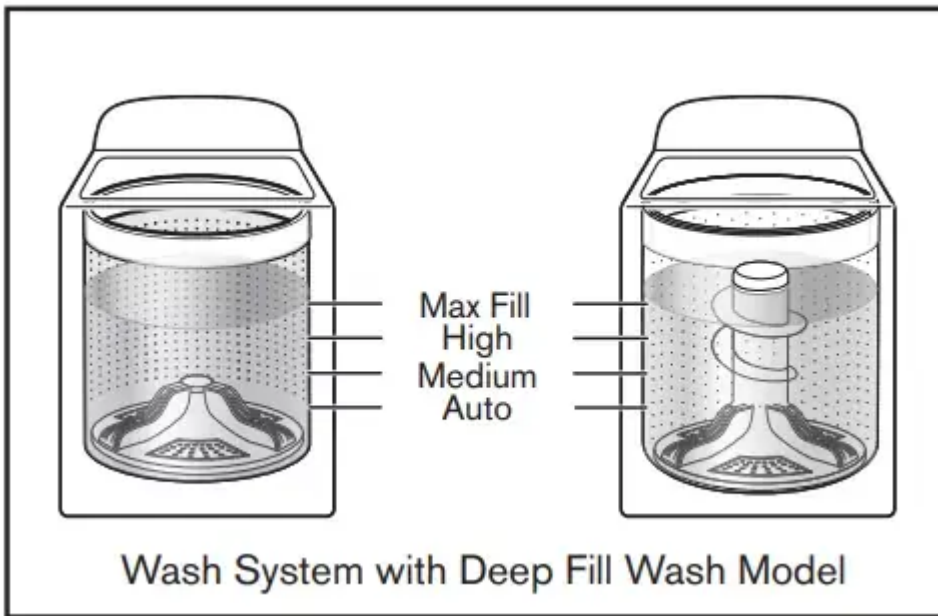

AUTO SENSING & DEEP FILL

- The washer will adjust the water level to the optimal amount for a High Efficiency wash of the detected load size.
- Touch “DEEP FILL” to add more water to the wash load.
- There are four levels of deep water “Auto”, “Medium”, “High”, “Max Fill”.
- Not all levels available on all cycles.

Cleaning with Less Water

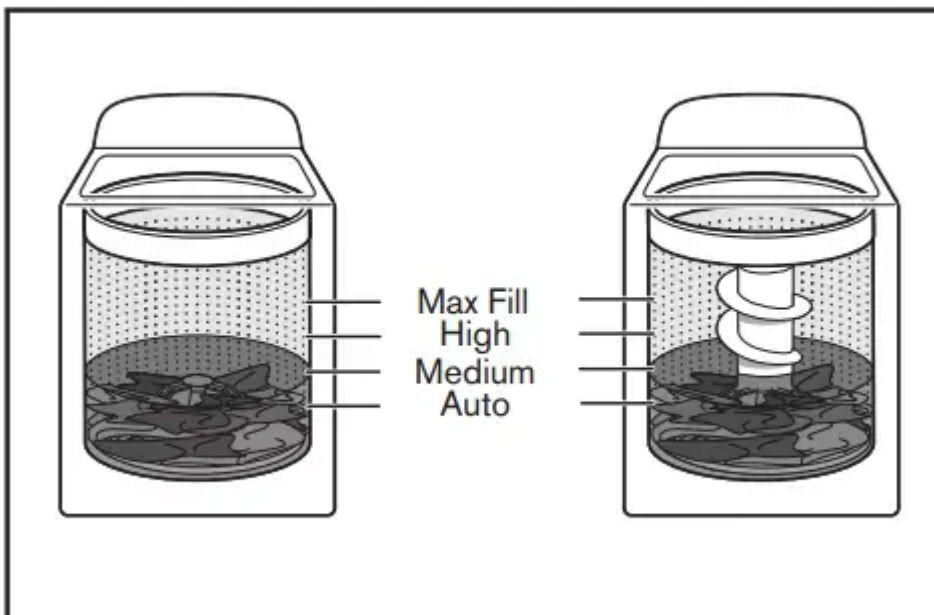

As the washer dampens and moves the load, the level of the items will settle in the basket. This is normal, and does not indicate that more items should be added.

IMPORTANT: You will not see a washer basket full of water as with your past agitator-style washer. It is normal for some of the load to be above the water line.

Boost Stain Fighting (on selected cycles)



EXTRA POWER Option

- Press the knob to select EXTRA POWER.
- When Extra Power is active the cycle control knob will illuminate.
- Extra Power will increase cleaning power in the cycle selected.

Rinsing Before Running a Wash Cycle

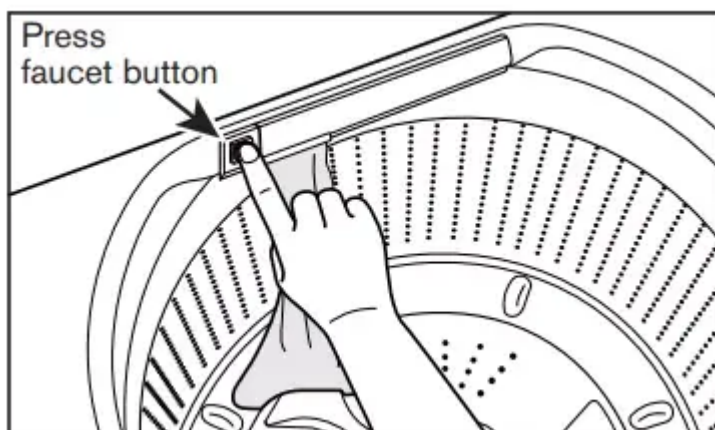

WATER FAUCET OPERATION

- Press the faucet button once to turn on.
- To turn the faucet off press the button again.
- Faucet will automatically shut off after 10 minutes or when max water level is reached.

- Water will automatically drain if water level becomes too high or if the lid is left open for 10 minutes.

CYCLE GUIDE

Settings shown are selectable for that cycle. Factory default settings are shown in **Bold**. Once you select a cycle, the default modifiers or the previous set modifiers for that cycle will be shown in the Display LCD. For best fabric care, choose the cycle that best fits the load being washed. Not all cycles and options are available on all models. Please refer to garment label instructions for best care.

Items to wash:	Cycle:	Temperature*:	SoilLevel:	Spin Speed:	Water Level:	Cy
Overly soiled garments, items that need additional cleaning effort	Heavy Duty	Hot Warm Cool Cold Tap Cold	ExtraHeavy Heavy Normal Light Extra Light	Fast Medium Off	Max Fill High Medium Auto	Us he stu Le pro lon ite be ab tha typ
Bright or darkly colored, casual and mixed loads	Colors	Hot Warm Cool Cold Tap Cold	Extra Heavy Heavy Normal Light Extra Light	Fast Medium Off	Max Fill High Medium Auto	Us wa co mi ac
Large items such as sheets, sleeping bags, small comforters, jackets, small washable rugs	Bulky Items	Hot Warm Cool Cold Tap Cold	Extra Heavy Heavy Normal Light Extra Light	Fast Medium Off	Max Fill	Us wa su sm Th wit to loa wa cyc us lev cyc
Heavily soiled, colorfast fabrics	Sanitize with Oxi	Hot	Extra Heavy	Fast Medium Off	Max Fill High Medium Auto	Us eli ba in Ox Pro se



Items to wash:	Cycle:	Temperature*:	SoilLevel:	Spin Speed:	Water Level:	Cy
						us pro Be Ox ba sta
Swimsuits and items requiring rinsing without detergent	Drain & Spin / Rinse & Spin	N/A	N/A	Fast Medium Off	N/A	Co sp op on rec ad to tim ad cyc loa cyc int wis Dr se SF wis & s DF cyc se RI
Cottons, linens, and mixed garment loads	Normal/ Regular	Hot Warm Cool Cold Tap Cold	Extra Heavy Heavy Normal Light Extra Light	Fast Off	High Medium Auto	Us no co fab
No-iron fabrics, perm	Wrinkle Control	Hot Warm Cool	Extra Heavy Heavy Normal	Fast Medium Off	Max Fill High Medium Auto	Us wa iro



Items to wash:	Cycle:	Temperature*:	SoilLevel:	Spin Speed:	Water Level:	Cy
press, synthetics		Cold Tap Cold	Light Extra Light			sp blo bu pe ble
Machine- wash silks, handwash fabrics	Delicates	Hot Warm Cool Cold Tap Cold	ExtraHeavy Heavy Normal Light Extra Light	Fast Medium Off	Max Fill High Medium Auto	Us wa ite “M Sil cyc lab ite ga be Th hig lev
Lightly soiled, small-sized mixed garment loads	Quick Wash	Hot Warm Cool Cold Tap Cold	ExtraHeavy Heavy Normal Light Extra Light	Fast Medium Off	Max Fill High Medium Auto	Us qu so an Th cyc pe int cle
No clothes in washer	Clean Washer with affresh*	N/A	N/A	N/A	N/A	Us 30 the wa cle us lev aff Cle liq



Items to wash:	Cycle:	Temperature*:	SoilLevel:	Spin Speed:	Water Level:	Cy
						ble the the wa sh int "W IM no or wa Cl aff thi em
Towels, jeans, casual, and mixed loads. Sturdy fabrics	Towels	Hot Warm Cool Cold Tap Cold	Extra Heavy Heavy Normal Light Extra Light	Fast Medium Off	Max Fill High Medium Auto	Pro wa alt wa he mi loa
Heavily soiled white fabrics	Whites	Hot Warm Cool Cold Tap Cold	Extra Heavy Heavy Normal Light Extra Light	Fast Medium Off	Max Fill High Medium Auto	Th us ble wh wh
Heavily soiled fabrics	Soak	Hot Warm Cool Cold Tap Cold	Extra Heavy Heavy Normal Light Extra Light	Off	Max Fill High Medium Auto	Us so se fab wil us ag so Aft ex



Items to wash:	Cycle:	Temperature*:	SoilLevel:	Spin Speed:	Water Level:	Cy
						dra bu no co

GET THE MAYTAG™ APP AND GET CONNECTED

With your mobile device download the Maytag™ app. You can get subscription and connectivity instructions, terms or use, and privacy policy at www.maytag.com/connect or in Canada www.maytag.ca/connect.

Once installed, launch the app and you will be guided through the steps to subscribe and create your user account to connect to your appliance. If you have any problems or questions, call Maytag® Connected Appliances at 1-866-333-4591.

1. CONNECTING UNIT TO INTERNET

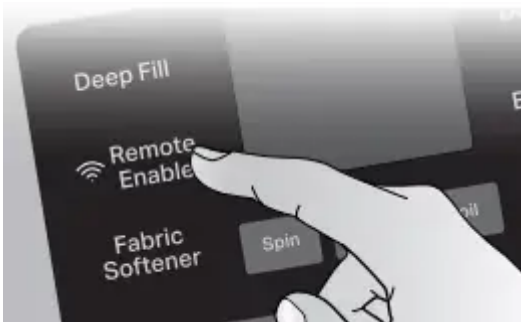

To connect your unit to the internet please download the Maytag™ App and press REMOTE ENABLE.



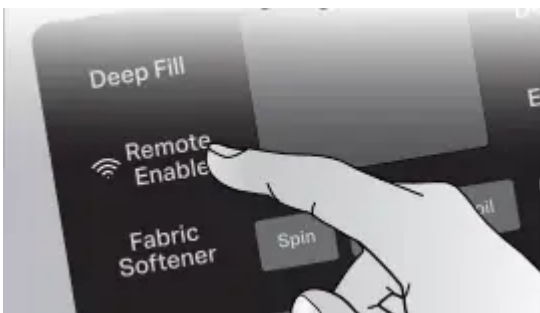











2. ALLOWING REMOTE CONTROL AND INTERACTION















User must press REMOTE ENABLE when connected in order to allow remote control and interaction.

WASHER ICONS



Image	Description	Status
	Door Locked	Alert State
	Remote Enable	On
	Delay Start	On
	Deep Fill	On - Auto
		On - Auto Medium
		On - Auto High
		On - Max Fill
	Fabric Softener	On
	Extra Rinse	On
	Smartgrid, Peak rates in effect	On
		Smart Delay
		Smart Pause
	WiFi Status Indicator	Connected
	Note: When the WiFi is disconnected, the priority goes to the first, then as other options added, it goes to the least again.	
		Disconnected
	Fabric Softener	Off

		
	Extra Rinse	Off
	Custom Cycle	
	Download & Go Cycle	
	Cycle Signal	Off
		Low
		Medium
		High
	Clean Washer	
	Remote Enable	Off
	Faucet	On
		Off

NOTE: Not all features and options are available on all models.

INSTALLATION REQUIREMENTS

Tools and Parts

Gather required tools and parts before starting installation.

Tools needed

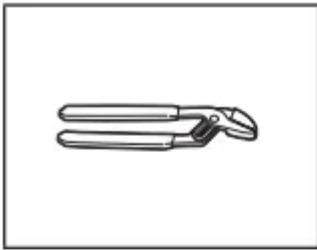

Pliers that open to 1 3/4"

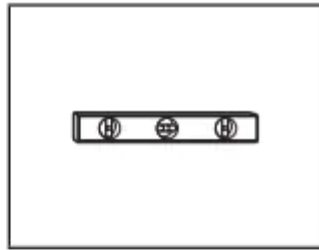

Level

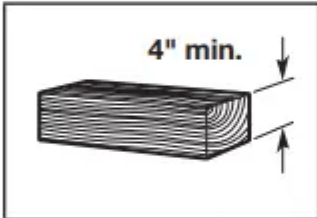

Wood Block

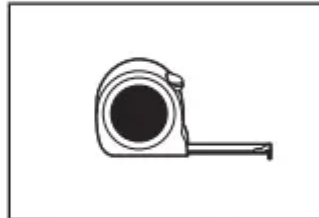

Ruler or measuring tape

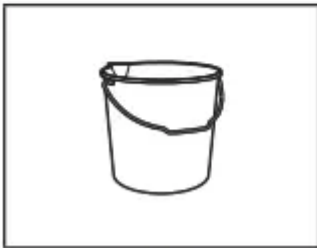

Bucket

Parts supplied:

NOTE: All parts supplied for installation are in cardboard insert in the top of the washer.



Drain hose with clamp,
U-form, and cable tie

Parts needed (Not supplied with washer):



Inlet hoses with flat
washers

Location Requirement

Select proper location for your washer to improve performance and minimize noise and possible “washer walk”. Install your washer in a basement, laundry room, closet, or recessed area.

Recessed area or closet installation

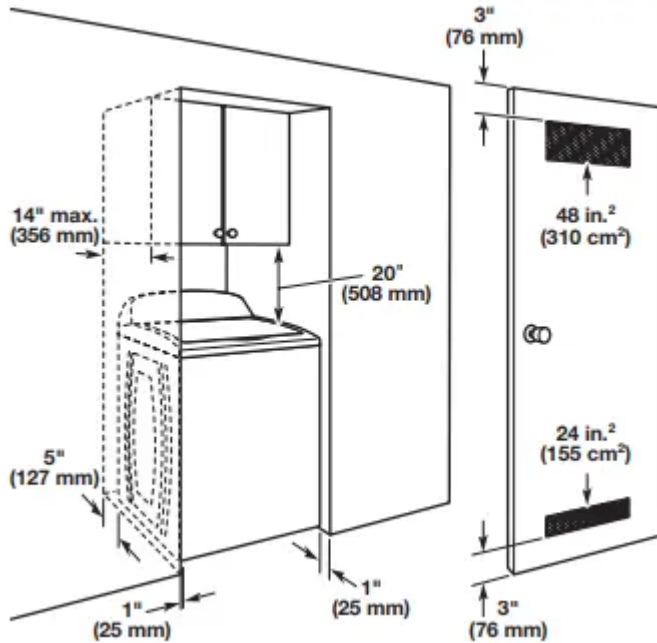

Dimensions show recommended spacing allowed, except for closet door ventilation openings which are minimum required. This washer has been tested for installation with spacing of 0" (0 mm) clearance on the sides. Consider allowing more space for ease of installation and servicing, and spacing for companion appliances and clearances for walls, doors, and floor moldings. Add spacing of 1" (25 mm) on all sides of washer to reduce noise transfer. If a closet door or louvered door is installed, top and bottom air openings in door are required.

Drain System

Drain system can be installed using a floor drain, wall standpipe, floor standpipe, or laundry tub. Select method you need.

Floor standpipe drain system

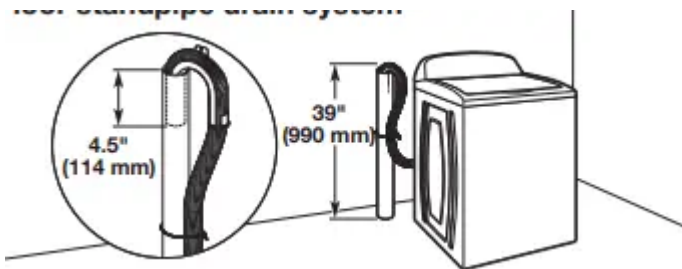

Minimum diameter for a standpipe drain: 2" (51 mm). Minimum carry-away capacity: 17 gal. (64 L) per minute. Top of standpipe must be at least 39" (990 mm) high; install no higher than 96" (2.44

m) from bottom of washer. If you must install higher than 96" (2.44 m), you will need a sump pump system.

Wall standpipe drain system

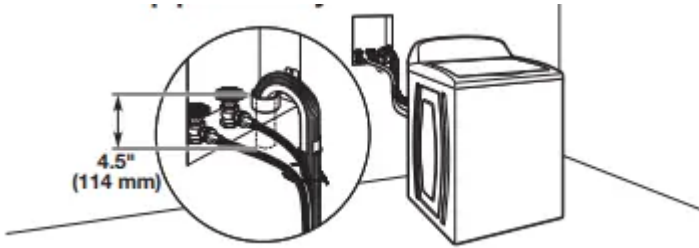

See requirements for floor standpipe drain system.

Floor drain system

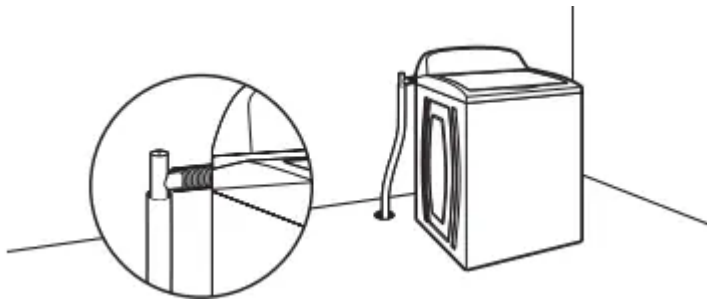

Floor drain system requires a Siphon Break Kit (Part Number 285834), 2 Connector Kits (Part Number 285835), and an Extension Drain Hose (Part Number 285863) that may be purchased separately. To order, please see toll-free phone numbers in "Assistance or Service" section. Minimum siphon break: 28" (710 mm) from bottom of washer. (Additional hoses may be needed.)

Laundry tub drain system

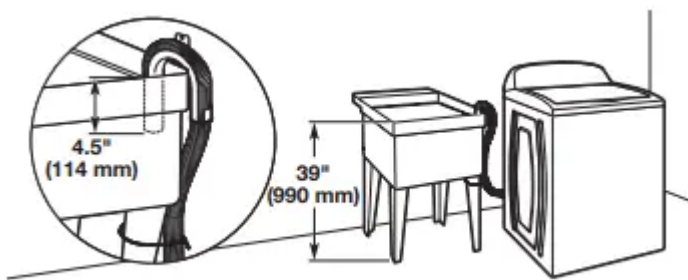

Minimum capacity: 20 gal. (76 L). Top of laundry tub must be at least 39" (990 mm) above floor; install no higher than 96" (2.44 m) from bottom of washer.

IMPORTANT: To avoid siphoning, no more than 4.5" (114 mm) of drain hose should be inside standpipe or below the top of wash tub. Secure drain hose with cable tie.

Electrical Requirements

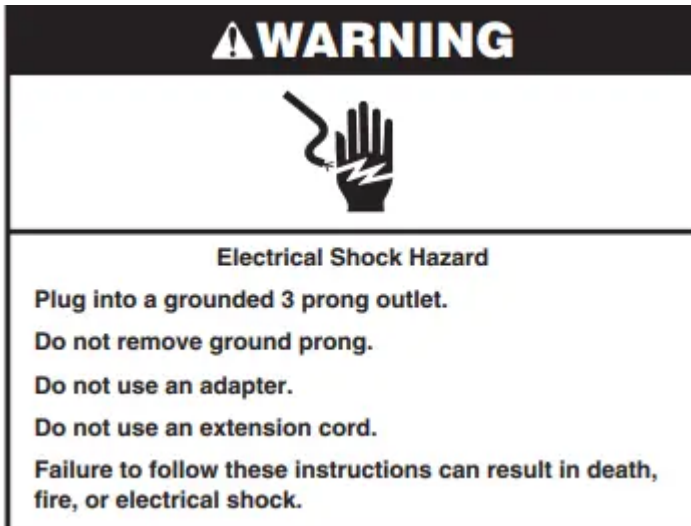

- A 120 V, 60 Hz., AC only, 15 or 20 A, fused electrical supply is required. A time-delay fuse or circuit breaker is recommended. It is recommended that a separate circuit breaker serving only this appliance be provided.
- This washer is equipped with a power supply cord having a 3 prong grounding plug.
- To minimize possible shock hazard, the cord must be plugged into a mating, 3 prong, grounding-type outlet, grounded in accordance with local codes and ordinances. If a mating outlet is not available, it is the personal responsibility and obligation of the customer to have the properly grounded outlet installed by a qualified electrician.
- If codes permit and a separate ground wire is used, it is recommended that a qualified electrician determine that the ground path is adequate.
- Do not ground to a gas pipe.
- Check with a qualified electrician if you are not sure the washer is properly grounded.
- Do not have a fuse in the neutral or ground circuit.

INSTALLATION INSTRUCTIONS

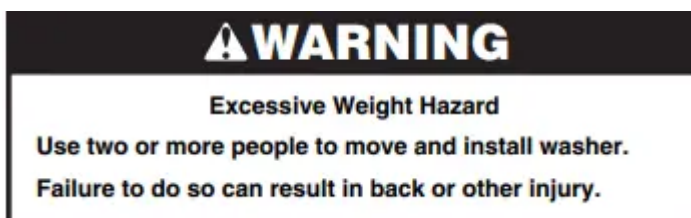

Before you start: Remove shipping materials.

It is necessary to remove all shipping materials for proper operation and to avoid excessive noise from washer.

1. Move washer

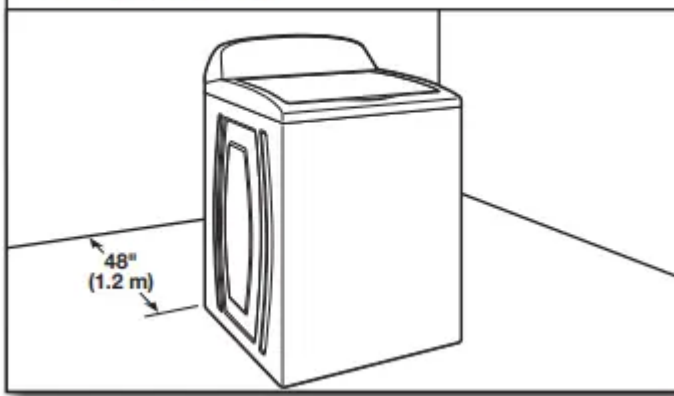

Move washer to within 4 ft. (1.2 m) of its final location; it must be in a fully upright position.

NOTE: To avoid floor damage, set washer onto cardboard before moving it and make sure lid is taped shut.

2. Remove shipping base

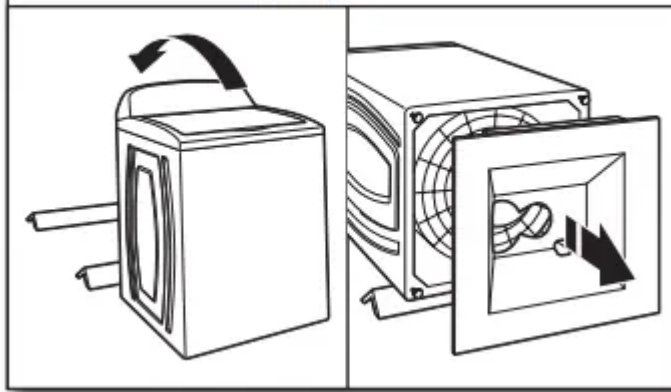

To avoid damaging floor, place cardboard supports from shipping carton on floor behind washer. Tip washer back and place on cardboard supports. Remove shipping base. Set washer upright.

IMPORTANT: Removing shipping base is necessary for proper operation. If your washer includes a sound shield, please refer to the instructions included with the sound shield to install it at this time.

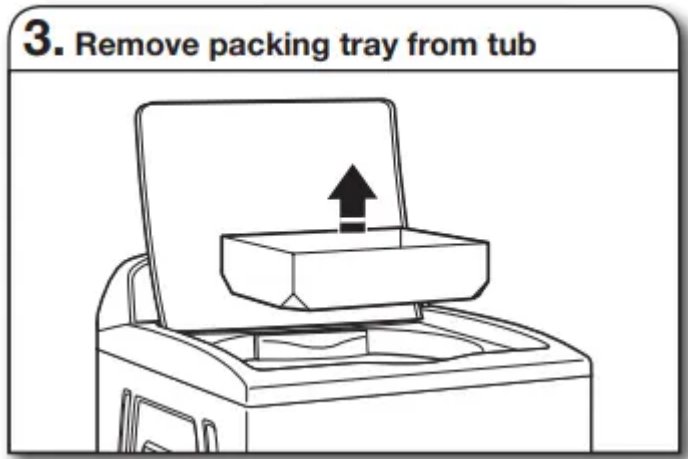

Remove tape from washer lid, open lid, and remove cardboard packing tray from tub. Remove all other packaging materials from washer tub. Be sure to remove all parts from tray.

NOTE: Keep tray in case you need to move washer later.

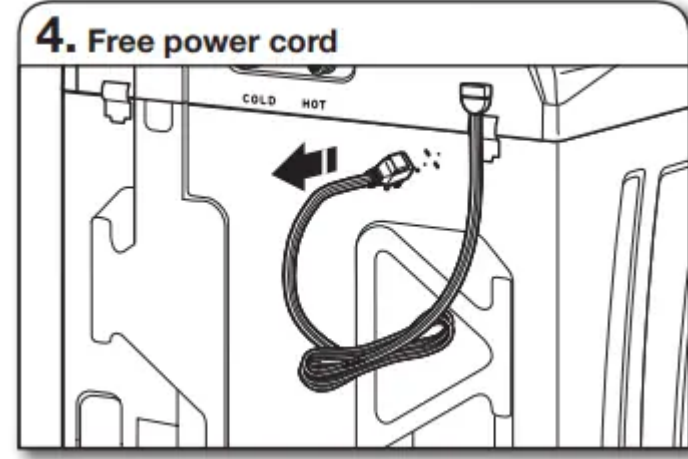

Firmly grasp power cord plug and pull to free from rear panel. Gently place power cord over console to allow free access to back of washer.



Connect Drain Hose

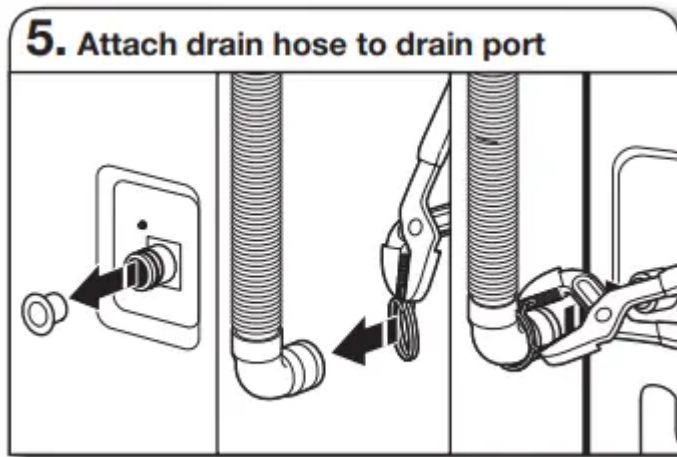

Remove the red plastic plug from the black drain port on the back of the washer.

If clamp is not already in place on elbow end of drain hose, slide it over end as shown. Squeeze clamp with pliers and slide black elbow end of drain hose onto black drain port and secure with clamp.

For a laundry tub or standpipe drain, go to step 6.

For a floor drain, remove the preinstalled drain hose form as shown in Step 7. You may need additional parts with separate directions. See the “Tools and Parts” section.

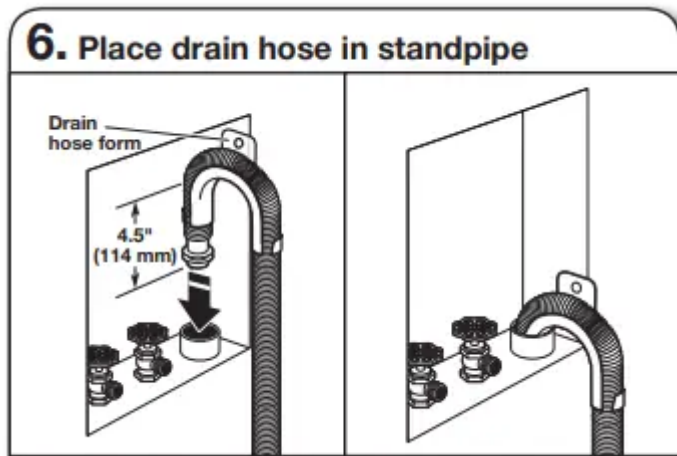

Place hose into standpipe (shown in picture) or over side of laundry tub.

IMPORTANT: 4.5" (114 mm) of drain hose should be inside standpipe; do not force excess hose into standpipe or lay on bottom of laundry tub. Drain hose form must be used.

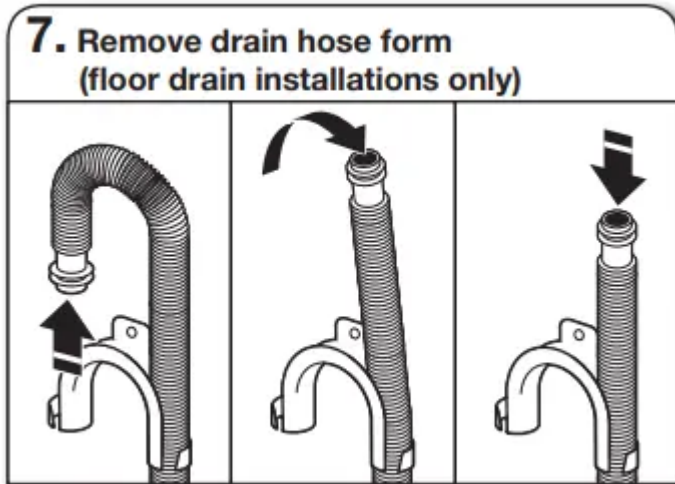

For floor drain installations, you will need to remove the drain hose form from the end of the drain hose. You may need additional parts with separate directions. See the “Tools and Parts” section.

Connect Inlet Hoses

Washer must be connected to water faucets with new inlet hoses with flat washers (not provided). Do not use old hoses.

NOTE: Both hoses must be attached and have water flowing to inlet valves. If you are only connecting to a cold water faucet, you must use a Y-adapter (not provided).

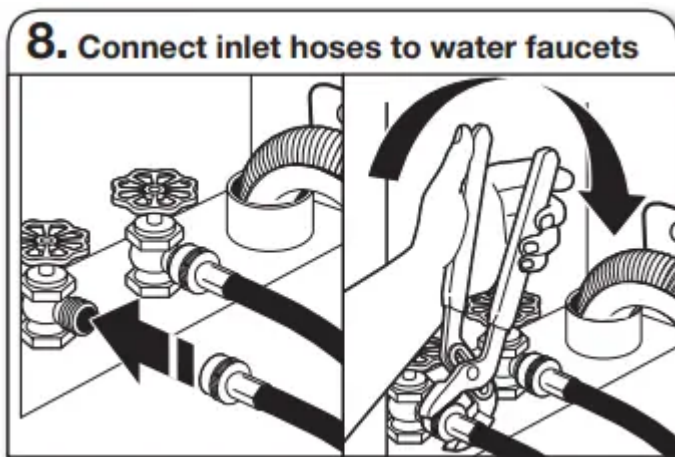

Attach hose to hot water faucet. Screw on coupling by hand until it is seated on washer. Use pliers to tighten couplings an additional two-thirds turn. Repeat this step with second hose for cold water faucet.

IMPORTANT: Do not overtighten or use tape or sealants on valve when attaching to faucets or washer. Damage can result.

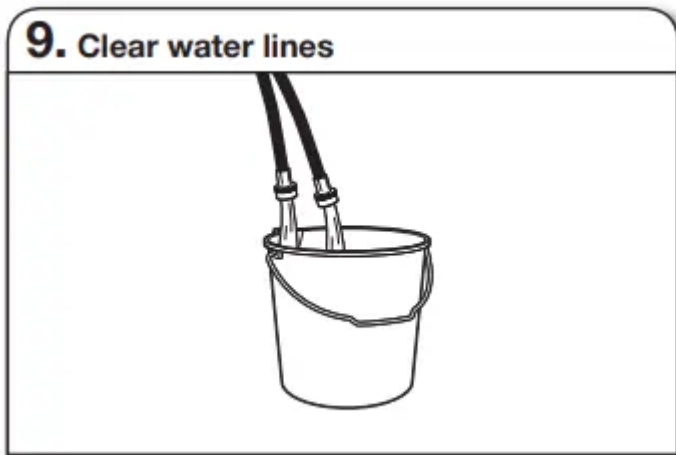

Run water for a few seconds through hoses into a laundry tub, drainpipe, or bucket to avoid clogs. Water should run until clear. Make note of which hose is connected to hot water to help in attaching hoses to washer correctly.

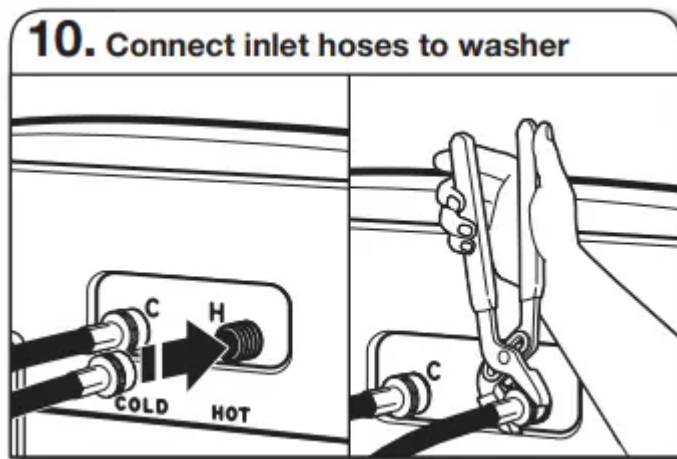

Attach hot water hose to hot water inlet valve marked with a red ring. Screw coupling by hand until it is snug. Use pliers to tighten couplings an additional two-thirds turn. Repeat with cold water inlet valve.

IMPORTANT: To reduce risk of hose failure, replace the hoses every five years. Record hose installation or replacement dates for future reference.

- Periodically inspect and replace hoses if bulges, kinks, cuts, wear, or leaks are found.

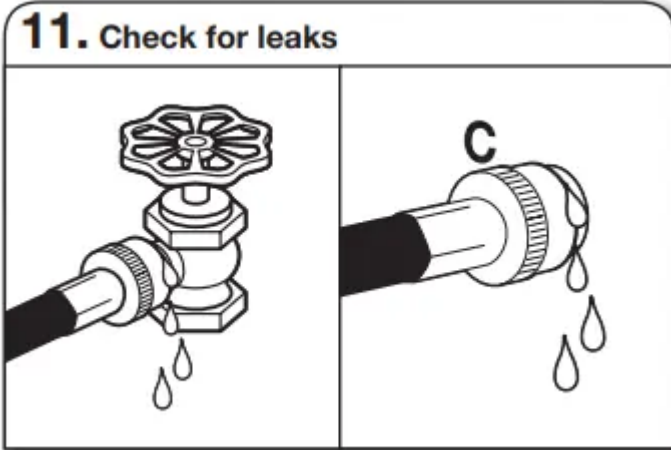

Turn on water faucets to check for leaks. A small amount of water may enter washer. It will drain later.

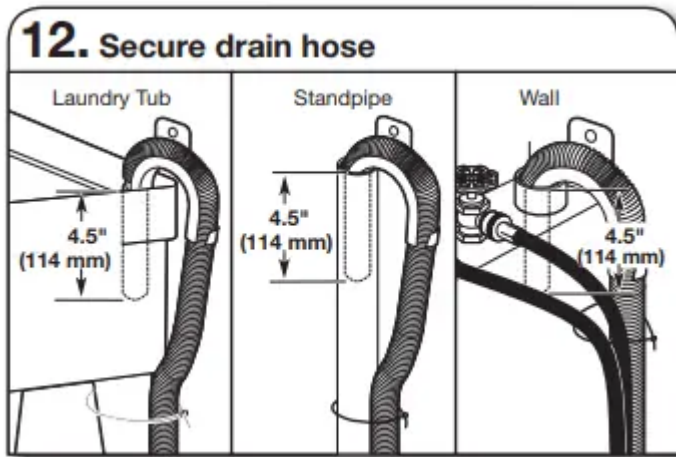

Secure drain hose to laundry tub leg, drain standpipe, or inlet hoses for wall standpipe with cable tie.

Level Washer

IMPORTANT: Level washer properly to reduce excess noise and vibration.



Move the washer to its final location. Place a level on top edges of washer. Use side seam as a guide to check levelness of sides. Check levelness of front using lid, as shown. Rock washer back and forth to make sure all four feet make solid contact with floor. If washer is level, skip to step 15.

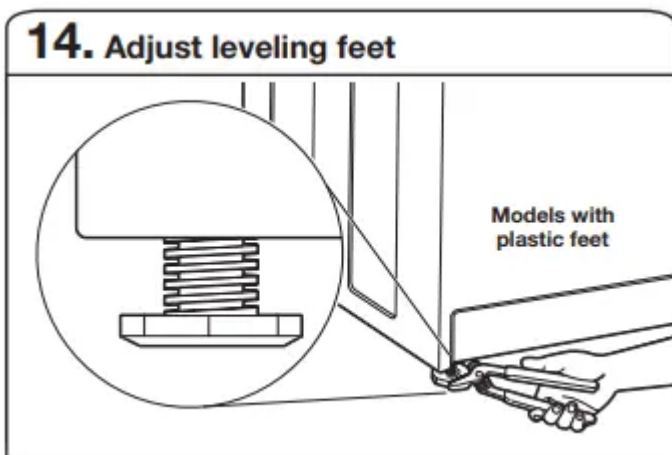
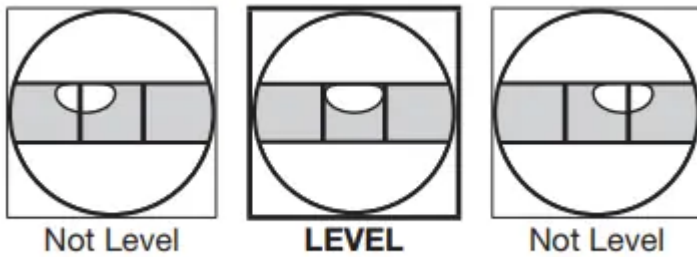

If washer is not level:

Use adjustable pliers to turn the plastic leveling foot counterclockwise to lower the washer or clockwise to raise the washer. On all models, recheck levelness of washer and repeat as needed.

HELPFUL TIPS:

- You may need to adjust two different feet to level your unit. Ensure each foot remains secured to the washer's base.
- You may want to prop up the front of the washer about 4" (102 mm) with a wood block or similar object that will support the weight of the washer when making the adjustments.



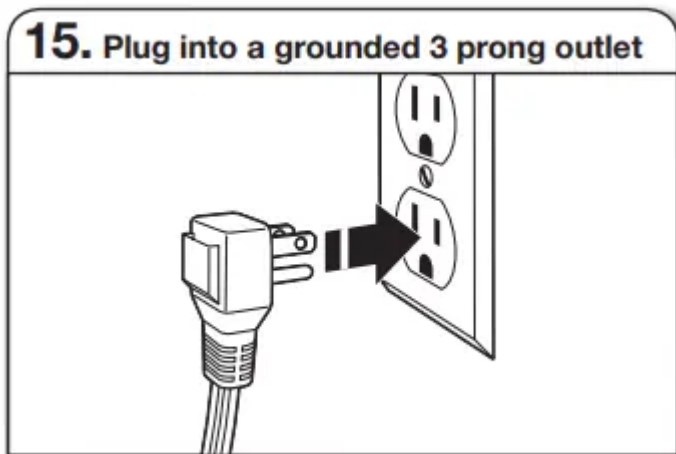

Complete Installation Checklist

- Check electrical requirements. Be sure you have correct electrical supply and recommended grounding method.
- Check that all parts are now installed. If there is an extra part, go back through steps to see what was skipped.
- Check that you have all of your tools.
- Check that shipping materials were completely removed from washer.
- Check that the washer is level.
- Check that water faucets are on.
- Check for leaks around faucets and inlet hoses.
- Remove protective film from console and any tape remaining on washer.
- Check that washer is plugged into a grounded 3 prong outlet.
- Dispose of/recycle all packaging materials.
- Read the “Washer Care” section in this book.
- To test and clean your washer, measure 1/2 of normal recommended amount of powdered or liquid detergent and pour it into washer basket or detergent dispenser (on some models). Close lid. Select any cycle. Start washer and allow to complete full cycle.

WASHER MAINTENANCE AND CARE

WATER INLET HOSES

Replace inlet hoses after 5 years of use to reduce the risk of hose failure. Periodically inspect and replace inlet hoses if bulges, kinks, cuts, wear, or leaks are found. When replacing your inlet hoses, mark the date of replacement on the label with a permanent marker.

NOTE: This washer does not include inlet hoses. See the “Installation & Care Instructions Manual” for more information.

WASHER CARE

Recommendations to Help Keep Your Washer Clean and Performing at its Best

1. Always use High Efficiency (HE) detergents and follow the HE detergent manufacturer's instructions regarding the amount of HE detergent to use. Never use more than the recommended amount because that may increase the rate at which detergent and soil residue accumulate inside your washer, which in turn may result in undesirable odor.
2. Use warm and hot wash water settings sometimes (not exclusively cold water washes), because they do a better job of controlling the rate at which soils and detergent accumulate.
3. Always leave the washer lid open between uses to help dry out the washer and prevent the buildup of odor-causing residue.

Cleaning Your Top Loading Washer

Read these instructions completely before beginning the routine cleaning processes recommended below. This Washer Maintenance Procedure should be performed, at a minimum, once per month or every 30 wash cycles, whichever occurs sooner, to control the rate at which soils and detergent may otherwise accumulate in your washer.

Cleaning the Inside of the Washer

To keep your washer odor-free, follow the usage instructions provided above, and use this recommended monthly cleaning procedure:

Clean Washer Cycle

This washer has a special cycle that uses higher water volumes in combination with affresh® Washer Cleaner or liquid chlorine bleach to clean the inside of the washer

Begin procedure

1. affresh® Washer Cleaner Cycle Procedure (Recommended for Best Performance):

1. Open the washer lid and remove any clothing or items.
2. Place an affresh® Washer Cleaner tablet in the bottom of the washer basket.
3. Do not place an affresh® Washer Cleaner tablet in the detergent dispenser.
4. Do not add any detergent or other chemical to the washer when following this procedure.
5. Close the washer lid.
6. Select the CLEAN WASHER cycle.
7. Touch and hold the START/PAUSE button to begin the cycle. The Clean Washer Cycle Operation is described below.

NOTE: For best results, do not interrupt cycle. If cycle must be interrupted, touch POWER. After the Clean Washer cycle has stopped, run a RINSE & SPIN cycle to rinse cleaner from washer.

2. Chlorine Bleach Procedure (Alternative):

1. Open the washer lid and remove any clothing or items.
2. Add 1 cup (236 mL) of liquid chlorine bleach to the bleach compartment.
 - **NOTE:** Use of more liquid chlorine bleach than is recommended above could cause washer damage over time.
3. Close the washer lid.
4. Do not add any detergent or other chemical to the washer when following this procedure.
 - e. Select the CLEAN WASHER cycle.
5. Touch and hold the START/PAUSE button to begin the cycle. The Clean Washer Cycle Operation is described below.
 - **NOTE:** For best results, do not interrupt cycle. If cycle must be interrupted, touch POWER. After the Clean Washer cycle has stopped, run a RINSE & SPIN cycle to rinse cleaner from washer

Description of Clean Washer Cycle Operation:

1. This cycle will fill to a water level higher than in normal wash cycles to provide rinsing at a level above the water line for normal wash cycle.
2. During this cycle, there will be some agitation and spinning to increase the removal of soils.

After this cycle is complete, leave the lid open to allow for better ventilation and drying of the washer interior.

Cleaning the Dispensers

After a period of using your washer, you may find some residue buildup in the washer's dispensers. To remove residue from the dispensers, wipe them with a damp cloth and towel dry. Do not attempt to remove the dispensers or trim for cleaning. The dispensers and trim are not removable. If your model has a dispenser drawer, however, remove the drawer and clean it before or after you run the Clean Washer cycle. Use an all purpose surface cleaner, if needed.

Cleaning the Outside of the Washer

Use a soft, damp cloth or sponge to wipe away any spills. Use only mild soaps or cleaners when cleaning external washer surfaces.

IMPORTANT: To avoid damaging the washer's finish, do not use abrasive products.

NON-USE AND VACATION CARE

Operate your washer only when you are home. If moving, or not using your washer for a period of time, follow these steps:

1. Unplug or disconnect power to washer.
2. Turn off water supply to washer, to avoid flooding due to water pressure surge.

CLEANING YOUR DISPENSER (*Varies according to model)

You may find laundry product residue leftover in your dispenser drawer or in bulk dispenser. To remove residue, follow below recommended cleaning procedures:

Dispenser Drawer

1. Pull drawer out until you feel resistance.
2. Push 2 tabs downward, and then continue pulling out.
3. Wash in warm, soapy water, using a mild detergent.
4. Rinse with warm water.
5. Air dry, or dry with a towel, then place back into slot.

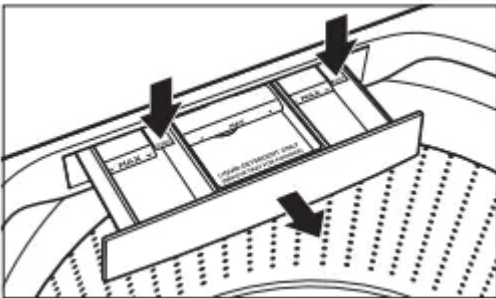

IMPORTANT: Dispenser drawer and tray are not dishwasher safe.

Bulk Dispenser

1. Pull drawer completely out.
2. Open dispenser lid.
3. Rinse with warm water.
4. Air dry or dry with a towel, then place back into slot.

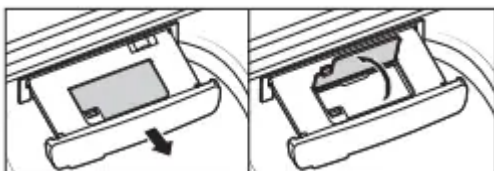

IMPORTANT: Bulk dispenser and tray are not dishwasher safe.

WINTER STORAGE CARE

IMPORTANT: To avoid damage, install and store washer where it will not freeze. Because some water may stay in hoses, freezing can damage washer. If storing or moving during freezing weather, winterize your washer.

To winterize washer:

1. Shut off both water faucets; disconnect and drain water inlet hoses.
2. Put 1 qt. (1 L) of R/V/-type antifreeze into empty basket.
3. Unplug washer or disconnect power.

TRANSPORTING YOUR WASHER

1. Shut off both water faucets. Disconnect and drain water inlet hoses.
2. If washer will be moved during freezing weather, follow WINTER STORAGE CARE directions before moving.
3. Disconnect drain hose from drain system and drain any remaining water into a pan or bucket. Disconnect drain hose from back of washer.
4. Unplug power cord.
5. Place inlet hoses and drain hose inside washer basket.
6. Drape power cord over edge and into washer basket.
7. Place packing tray from original shipping materials back inside washer. If you do not have packing tray, place heavy blankets or towels into basket opening. Close lid and place tape over lid and down front of washer. Keep lid taped until washer is placed in new location. Transport washer in upright position

REINSTALLING/USING WASHER AGAIN

To reinstall washer after non-use, vacation, winter storage, or moving:

1. Refer to “Installation & Care Instructions Manual” to locate, level, and connect washer.
2. Before using again, run washer through the following recommended procedure:

To use washer again:

1. Flush water pipes and hoses. Reconnect water inlet hoses. Turn on both water faucets.
2. Plug in washer or reconnect power.
3. Run washer through BEDDING cycle to clean washer and remove antifreeze, if used. Use only HE (High Efficiency) detergent. Use ½ the manufacturer’s recommended amount for a medium-size load.

Warning



This content is compiled from multiple sources and is provided for reference purposes only. It may not be complete or fully applicable to all situations. If you are unable to resolve your issue, please contact the product manufacturer or an authorized service provider for official support.

Document generated by [ManualsFile](#)

