

FIRST STEPS

This Owner's Guide provides specific operating instructions for your model. Use the freezer only as instructed in this Owner's Guide. **Before starting the freezer, follow these important first steps.**

INSTALLATION

- Choose a place that is near a grounded electrical outlet. Do Not use an extension cord or an adapter plug.
- For the most efficient operation, the freezer should be located where surrounding temperatures will not exceed 110°F (43°C). Temperatures of 32°F (0°C) and below will NOT affect freezer operation. Additional compressor heaters are not recommended.
- Allow space around the unit for good air circulation. Leave a 3 inch (75 mm) space on all sides of the freezer for adequate circulation.

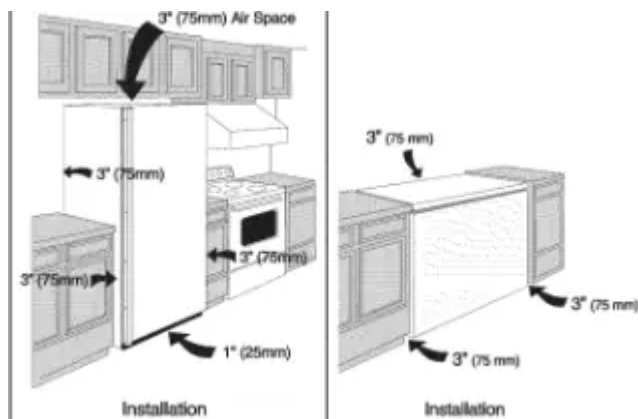

NOTE: The exterior walls of the freezer may become quite warm as the compressor works to transfer heat from the inside. Temperatures as much as 30° F warmer than room temperature can be expected. For this reason it is particularly important in hotter climates to allow enough space for air circulation around your freezer.

LEVELING

The freezer must have all bottom corners resting firmly on a solid floor. The floor must be strong enough to support a fully loaded freezer. **NOTE:** It is VERY IMPORTANT for your freezer to be level in order to function properly. If the freezer is not leveled during installation, the door may be misaligned and not close or seal properly, causing cooling, frost, or moisture problems.

To Level Upright Models:

After discarding crating screws and wood base, use a carpenter's level to level the freezer from front-to-back. Adjust the plastic leveling feet in front, Y2bubble higher, so that the door closes easily when left halfway open.

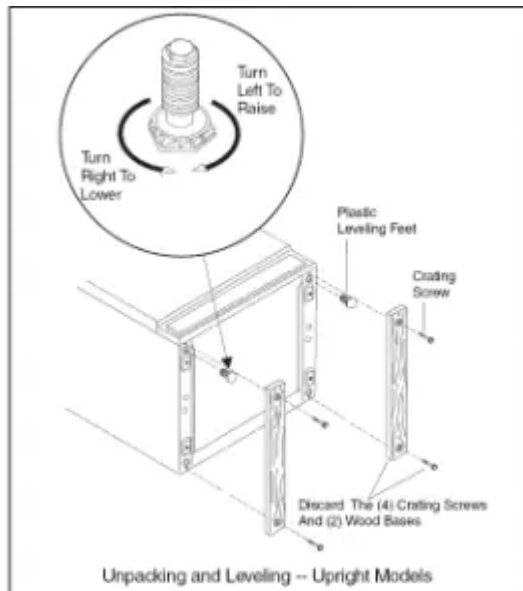

To Level Chest Models:

If needed, add metal or wood shims between foot pads and floor.

CLEANING (PRIOR TO USE)

- Wash any removable parts, the freezer interior, and exterior with mild detergent and warm water. Wipe dry. **Do not use harsh cleaners on these surfaces.**
- Do not use razor blades or other sharp instruments, which can scratch the appliance surface when removing adhesive labels. Any glue left from the tape can be removed with a mixture of warm water and mild detergent, or touch the residue with the sticky side of tape already removed. **Do not remove the serial plate.**



DOOR REMOVAL (NON-ELECTRONIC MODELS)

If door must be removed:

1. Gently lay freezer on its back, on a rug or blanket.
2. Remove two base screws and base panel.

3. Remove bottom hinge screws.
4. Remove plastic top hinge cover.
5. Remove screws from top hinge.
6. Remove top hinge from cabinet.
7. Remove door and bottom hinge from cabinet.
8. To replace door, reverse the above order and securely tighten all screws to prevent hinge slippage.

DOOR REMOVAL (ELECTRONIC MODELS)

If door must be removed:

- Door hinge is fastened with tamper-proof screws. Please have a qualified technician remove the door.

ENERGY SAVING TIPS

- The freezer should be located in the coolest area of the room, away from heat producing appliances or heating ducts, and out of direct sunlight.
- Let hot foods cool to room temperature before placing in the freezer. Overloading the freezer forces the compressor to run longer. Foods that freeze too slowly may lose quality or spoil.
- Be sure to wrap foods properly, and wipe containers dry before placing them in the freezer. This cuts down on frost build-up inside the freezer.
- Freezer shelves should not be lined with aluminum foil, wax paper, or paper toweling. Liners interfere with cold air circulation, making the freezer less efficient.
- Organize and label food to reduce door openings and extended searches. Remove as many items as needed at one time, and close the door as soon as possible.

SETTING THE TEMPERATURE CONTROL

COOL DOWN PERIOD

- For safe food storage, allow 4 hours for the freezer to cool down completely. The freezer will run continuously for the first several hours. Foods that are already frozen may be placed in the freezer after the first few hours of operation. Unfrozen foods should NOT be loaded into the freezer until the freezer has operated for 4 hours.
- When loading the freezer, freeze only 3 pounds of fresh food per cubic foot of freezer space at one time. Distribute packages to be frozen evenly throughout the freezer. It is not necessary to turn the control knob to a colder setting while freezing food.

TEMPERATURE CONTROL

Electromechanical Temperature Control (Chest and Some Upright Models)

The electromechanical temperature control is located inside the freezer on upright models, and on the left exterior wall on chest models (see figure 1). The temperature is factory preset to provide satisfactory food storage temperatures. However, the temperature control is adjustable to provide a range of temperatures for your personal satisfaction. To adjust the temperature setting, turn the temperature control knob clockwise or counter clockwise. Allow several hours for the temperature to stabilize between adjustments.

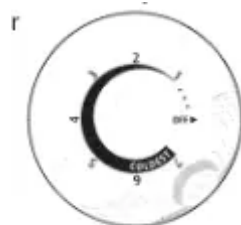

Figure 1

Standard Electronic Temperature Control (Some Upright Frost Free Models)

The standard electronic temperature control is located outside the freezer (see Figure 1). Temperature is factory preset to provide satisfactory food storage temperatures. To adjust the temperature setting, move the UP (A) symbol for colder temperatures and DOWN (v) symbol for warmer temperatures on the control panel. Allow several hours for the temperature to stabilize between adjustments.

To turn off freezer, press DOWN (v) symbol until display shows "1". Press three more times until display shows "0". To activate freezer, press UP (A) three times until display shows "1" then press to desired setting.

To keep the temperature setting from being accidentally changed, the control may be locked. This is done by pressing "Alarm Reset" for 3 seconds. will then appear on display. To unlock the control, press "Alarm Reset" for 3 seconds. For the first second, U" will appear, and then the current temperature will appear.



Standard Electronic
Temperature Control
Figure 1

- Temp Alarm

This feature is designed to provide a warning if the inside temperature exceeds 23°R "HI TEMP" feature operates on household electricity. It will not function if household electricity is interrupted.

- When the freezer is initially plugged in, the red HI TEMP" indicator will be on and the buzzer will sound. The indicator light will stay on until the freezer temperature is below 23°R To silence the buzzer, press the ALARM RESET button.
- If a malfunction causes the temperature inside the freezer to rise above 23°F, the "HI TEMP" light will turn on and the buzzer will sound. The buzzer will sound every five minutes until the freezer temperature is below 23°R To silence the buzzer, press the ALARM RESET button.
- Door Ajar Alarm

This feature provides a warning if the the door is open for more than five minutes. There will be a beep every five seconds and the "Door Ajar" indicator will light up. Press "Alarm Reset" to turn the alarm off. The "Door Ajar" indicator will remain lit unril the door is closed. If the door remains open for 15 minutes or more, the interior lamp will turn off.

Should an "E" appear on display, contact your authorized service technician for repair. Until changes are made, freezer will continue to run.

Deluxe Electronic Temperature Control (Some Upright Frost Free Models)

Refer to the Electronics Control Guide supplied when you purchase a deluxe electronic upright model. See Figure 3 for deluxe electronics control panel.



Upright Models
Figure 3

FREEZER OPTIONAL FEATURES

NOTE: Your freezer may have some, or all of the features listed below. Become familiar with these features, and their use and care.

SECURITY LOCK WITH POP-OUT KEY

This security lock fastens the door snugly, ensuring stored food is secure. To lock or unlock the freezer, push the key into the lock and turn. The key pops out of the lock after it has been turned.

SLIDE-OUT BASKET (SOME UPRIGHT MODELS)

A Slide-Out Basket (some models), located at the bottom of the freezer, provides separate storage space for items that are difficult to store on freezer shelves. To remove the basket, pull out and lift up.

INTERIOR LIGHT

The light comes on automatically when the door is opened. To replace the light bulb, turn the temperature control to OFF and **unplug the electrical cord**. Replace the old bulb with a bulb of the same wattage.

ADJUSTABLE SHELF (SOME UPRIGHT MODELS)

This shelf can be moved to one or two positions. Lift the shelf up and out to move to the desired location.

SLIDE-ASIDE BASKET (SOME CHEST MODELS)

This basket helps organize odd-shaped items. To reach other packages in the freezer, slide the basket aside, or lift out.



FAST FREEZING SHELVES (MANUAL DEFROST UPRIGHT MODELS)

These shelves contain cooling coils to freeze foods quickly and allow cold air to constantly circulate throughout the freezer. Do not use sharp metal objects such as ice picks or scrapers to clean the shelves. This could damage the shelves and reduce their cooling ability. These shelves are not adjustable.

TILT-OUT SHELF (SOME UPRIGHT MODELS)

This shelf is located inside on the freezer door and provides additional storage space. To access an item, tilt the top of the "basket" shelf down.

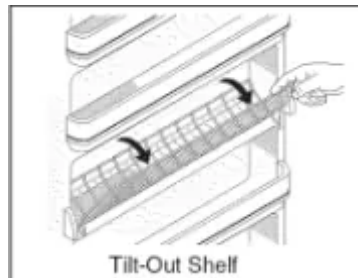

ADJUSTABLE DOOR BINS (SOME UPRIGHT MODELS)

Adjustable door bins are located inside on the freezer door and provide flexible storage space. The number of bins provided varies by model.

SOFT FREEZE ZONE (SOME UPRIGHT MODELS)

Soft Freeze Zone is specifically designed to maintain a higher temperature than the rest of the freezer to store products such as ice cream.

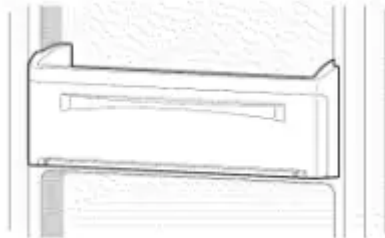

PIZZA SHELF (SOME UPRIGHT MODELS)

Here is the place to store up to four extra-large boxes of frozen pizza without ever having to dig them out from beneath a pile of other stored goods.

The pizza shelf can be retracted to provide space for larger items on the shelf below and still store up to two more pizzas.

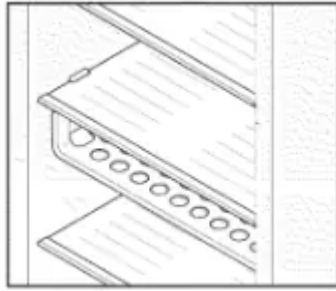

BASKET DIVIDER (SOME UPRIGHT MODELS)

Use these handy dividers to keep the various items stored in your baskets more organized. To change the location of the divider simply slide your basket out, grab the divider from the center and rotate in a counter-clockwise direction until it is disengaged. To assemble, simply align as shown in the figure below and rotate in a clockwise direction until it spans into place.

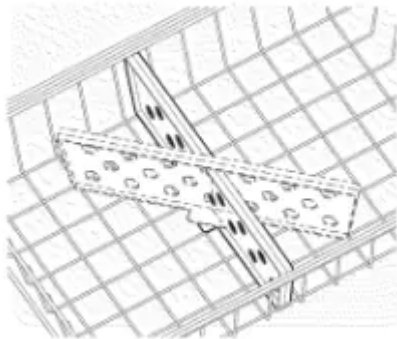

SHELF BOOKEND (SOME UPRIGHT MODELS)

Glass Shelf Bookend

Use these handy bookends to keep the various boxed items stored neatly in your freezer. To adjust location, simply slide where desired.

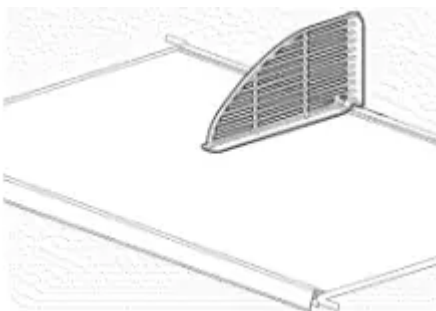

Wire Shelf Bookend

Use these handy bookends to keep the various boxed items stored neatly in your freezer. To adjust location, simply unsnap the bookend from the wire shelf and snap into the next desired location.

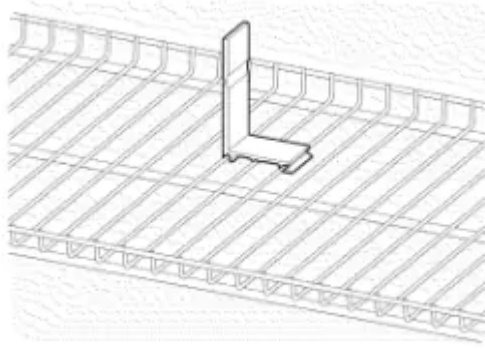

CHEST DIVIDER (SOME CHEST MODELS)

Use these clever dividers to custom=arrange a variety of different-sized storage bins inthe bottom of your chest freezer.

Use the peel-n-stick labels found in your literature packet to help remind you which items are stored where. If you have an item that isn't already covered by one of the pre-printed labels then use one of the blank labels and a permanent marking pen to make your own custom label. Labels can be peeled off when no longer needed and replaced by new and different ones.

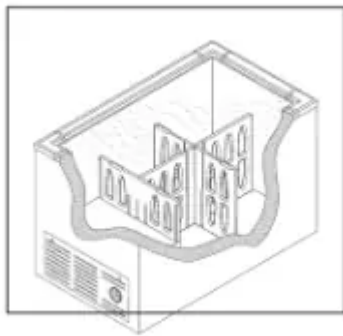

Examples of Chest Divider Configurations:

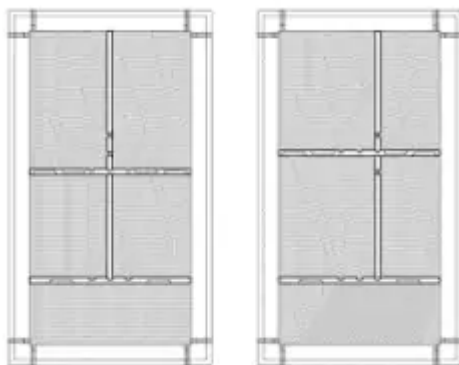

CARE AND CLEANING

CAUTION Damp objects stick to cold metal surfaces. Do not touch interior metal surfaces with wet or damp hands.
Freezer must be unplugged (to avoid electrical hazard) from power source when defrosting unit.

Some upright freezers are frost-free and defrost automatically, but should be cleaned occasionally.

BETWEEN DEFROSTINGS

To avoid frequent defrosting, occasionally use a plastic scraper to remove frost. Scrape with a pulling motion. Never use a metal instrument to remove frost.

DEFROSTING

It is important to defrost and clean the freezer when 1/2 to 1/2 inch of frost has accumulated. Frost may tend to accumulate faster on the upper part of the freezer due to warm, moist air entering the freezer when the door is opened.

Remove food and leave the door open when defrosting the freezer.

To Defrost Upright Models with Defrost Drain:

- Remove the drain plug on the inside floor of the freezer by pulling it straight out.
- To access external drain tube on models with a base panel, first remove the two screws from the base panel. Locate the drain tube near the left center under the freezer.
- Place a shallow pan under the drain tube. Defrost water will drain out. Check the pan occasionally so water does not overflow (see figure 1).
- A 1/2 inch garden hose adapter can be used to drain the freezer directly into a floor drain. If your model is not equipped with an adapter, one can be purchased at most hardware stores.
- Replace the drain plug when defrosting and cleaning are completed. If the drain is left open, warm air may enter the freezer.

To Defrost Chest Models with Defrost Drain:

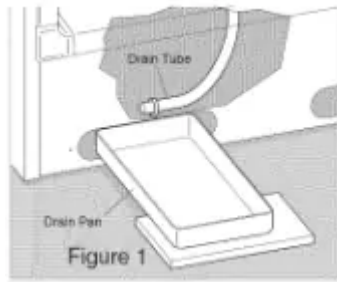

- Place a shallow pan or the Divider/Drain Pan (if equipped) beneath the drain outlet. Pull out the outside drain plug (see figure 2). A 2-inch garden hose adapter can be used to drain the freezer directly into a floor drain (see figure 3). If your model is not equipped with an adapter, one can be purchased at most hardware stores.
- Pull out the drain plug inside the freezer (see figure 4). Defrost water will drain out. Check pan occasionally so water does not overflow.
- Replace the drain plugs when defrosting and cleaning are completed. If the drain is left open, warm air may enter the freezer.

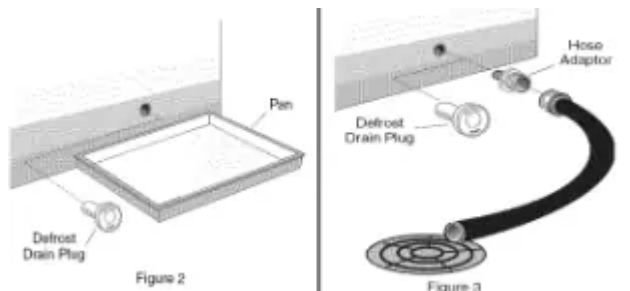

To Defrost Models without Defrost Drain:

- Place towels or newspapers on the freezer bottom to catch the frost. The frost will loosen and fall.
- Remove the towels and/or newspapers.
- If the frost is soft, remove it by using a plastic scraper. If the frost is glazed and hard, fill deep pans with hot water and place them on the freezer bottom.
- Close the freezer door/lid. Frost should soften in about fifteen (15) minutes.
- Repeat this procedure if necessary.

CLEANING THE INSIDE

After defrosting, wash inside surfaces of the freezer with a solution of two tablespoons of baking soda in one quart (litres) warm water. Rinse and dry. Wring excess water out of the sponge or cloth when cleaning in the area of the controls, or any electrical parts.

Wash the removable parts and door basket with the baking soda solution mentioned above, or mild detergent and warm water. Rinse and dry. Never use metallic scouring pads, brushes, abrasive cleaners, or alkaline solutions on any surface. Do not wash removable parts in a dishwasher.

CLEANING THE OUTSIDE

Wash the cabinet with warm water and mild liquid detergent. Rinse well and wipe dry with a clean soft cloth. Replace parts and food.

Do not use razor blades or other sharp instruments, which can scratch the freezer surface when removing adhesive labels. Any glue left from the tape can be removed with a mixture of warm water and mild detergent, or touch the residue with the sticky side of the tape already removed.

DO NOT REMOVE THE SERIAL PLATE.

VACATION AND MOVING TIPS

Short Vacations:

- Leave the freezer operating during vacations of less than three weeks.

Long Vacations:

If the freezer will not be used for several months:

- Remove all food and unplug the power cord.
- Clean and dry the interior thoroughly.
- Leave the freezer door open slightly, blocking it open if necessary, to prevent odor and mold growth.

Moving: When moving the freezer, follow these guidelines to prevent damage:

- Disconnect the power cord plug from the wall outlet.
- Remove foods, then defrost, and clean the freezer.
- Secure all loose items such as base panel, baskets, and shelves by taping them securely in place to prevent damage.
- In the moving vehicle, secure freezer in an upright position to prevent movement. Also protect outside of freezer with a blanket, or similar item.

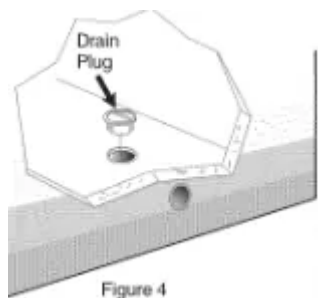

POWER FAILURE/ FREEZER FAILURE

If a power failure occurs, frozen foods will stay frozen for at least 24 hours if the freezer is kept closed. If the power failure continues, pack seven or eight pounds of dry ice into the freezer every 24 hours. Look in the Yellow Pages under Dry Ice, Dairies, or Ice Cream Manufacturers for local dry ice suppliers. Always wear gloves and use caution when handling dry ice.

If the freezer has stopped operating, see Freezer Does Not Run in the Troubleshooting Guide. If you cannot solve the problem, call an authorized servicer immediately. If the freezer remains off for several hours, follow the directions above for the use of dry ice during a power failure. If necessary, take the food to a local locker plant until the freezer is ready to operate. Look in the Yellow Pages under Frozen Food Locker Plants.

TROUBLE SHOOTING GUIDE

FREEZER DOES NOT RUN

1. Freezer does not run.

- Freezer is plugged into a circuit that has a ground fault interrupt - Use another circuit. If you are unsure about the outlet, have it checked by a certified technician.
- Temperature control is in the OFF position - See Setting the Temperature Control Section.
- Freezer may not be plugged in, or plug may be loose - Ensure plug is tightly pushed into outlet.
- House fuse blown or tripped circuit breaker - Check/replace fuse with a 15 amp time-delay fuse. Reset circuit breaker.
- Power outage - Check house lights. Call local Electric Company.

2. Freezer runs too much or too long

- Room or outside weather is hot - It's normal for the freezer to work harder under these conditions.
- Freezer has recently been disconnected for a period of time - It takes 4 hours for the freezer to cool down completely.
- Large amounts of warm or hot food have been stored recently - Warm food will cause freezer to run more until the desired temperature is reached.
- Doors are opened too frequently or too long - Warm air entering the freezer causes it to run more. Open doors less often.
- Freezer door may be slightly open - See "DOOR PROBLEMS" Section.
- Temperature Control is set too low - Turn control knob to a warmer setting. Allow several hours for the temperature to stabilize.
- Freezer gasket is dirty, worn, cracked, or poorly fitted - Clean or change gasket. Leaks in the door seal will cause freezer to run longer in order to maintain desired temperature.

3. Interior Freezer temperature is too cold.

- Temperature Control is set too low - Turn the control to a warmer setting. Allow several hours for the temperature to stabilize.

4. Interior Freezer temperature is too warm.

- Temperature Control is set too warm - Turn control to a colder setting. Allow several hours for the temperature to stabilize.
- Door is kept open too long or is opened too frequently - Warm air enters the freezer every time the door is opened. Open the door less often.
- Door may not be seating properly - See "DOOR PROBLEMS" Section.
- Large amounts of warm or hot food may have been stored recently - Wait until the freezer has had a chance to reach its selected temperature.
- Freezer has recently been disconnected for a period of time - Freezer requires 4 hours to cool down completely.

5. Freezer external surface temperature is warm.

- The external freezer walls can - This is normal while the compressor works to transfer be as much as 30°F warmer heat from inside the freezer cabinet. than room temperature.

SOUND AND NOISE

1. Louder sound levels whenever e freezer is on.

- Modern freezers have increased storage capacity and more stable temperatures. They require a high efficiency compressor - This is normal. When the surrounding noise level is low, you might hear the compressor running while it cools the interior.

2. Longer sound levels when compressor comes on.

- Freezer operates at higher pressures during the start of the ON cycle - This is normal. Sound will level off or disappear as freezer continues to run.

3. Popping or cracking sound when compressor comes on.

- Metal parts undergo expansion pipes - This is normal. Sound will level off or disappear as and contraction, as in hot water freezer continues to run.

4. Bubbling or gurgling sound like water boiling

- Refrigerant (used to cool freezer) is circulating throughout the system - This is normal

5. Vibrating or rattling noise.

- Freezer is not level. It rocks on the floor when it is moved slightly - Level the unit. Refer to "Leveling" in the **First Steps**
- Floor is uneven or weak. Freezer rocks on floor when it is moved slightly. - Ensure floor can adequately support freezer. Level the freezer by putting wood or metal shims under part of the freezer.
- Freezer is touching the wall - Relevel the freezer or move freezer slightly. Refer to "Leveling" in the First Steps Section.

WATER/MOISTURE/FROST INSIDE FREEZER

1. Moisture forms on inside freezer walls.

- Weather is hot and humid, which increases internal rate of frost build-up - This is normal.
- Door may not be seating properly - See "DOOR PROBLEMS" Section.
- Door is kept open too long, or is opened too frequently - Open the door less often.

WATER/MOISTURE/FROST OUTSIDE FREEZER

1. Moisture forms on outside of freezer.

- Door may not be seating properly, causing the cold air from inside the freezer to meet warm moist air from outside - See "DOOR PROBLEMS" Section.

ODOR IN FREEZER

1. Odors in freezer

- Interior needs to be cleaned - Clean interior with sponge, warm water, and baking soda.
- Foods with strong odors are in the freezer - Cover the food tightly.

DOOR PROBLEMS

1. Door will not close.

- Freezer is not level. It rocks on the floor when it is moved slightly - This condition can force the cabinet out of square and misalign the door. Refer to "Leveling" in the First Steps Section.
- Floor is uneven or weak. Freezer rocks on floor when it is moved slightly - Level the floor by using wood or metal shims under the freezer or brace floor supporting the freezer.

LIGHT BULB IS NOT ON

1. Light bulb is not on

- Light bulb is burned out - Follow directions under "Interior Light" in the Freezer Features Section.
- No electric current is reaching the freezer - See "FREEZER DOES NOT RUN" Section.

Warning

This content is compiled from multiple sources and is provided for reference purposes only. It may not be complete or fully applicable to all situations. If you are unable to resolve your issue, please contact the product manufacturer or an authorized service provider for official support.