

PRODUCT SETTING

SETTING UP YOUR OVEN

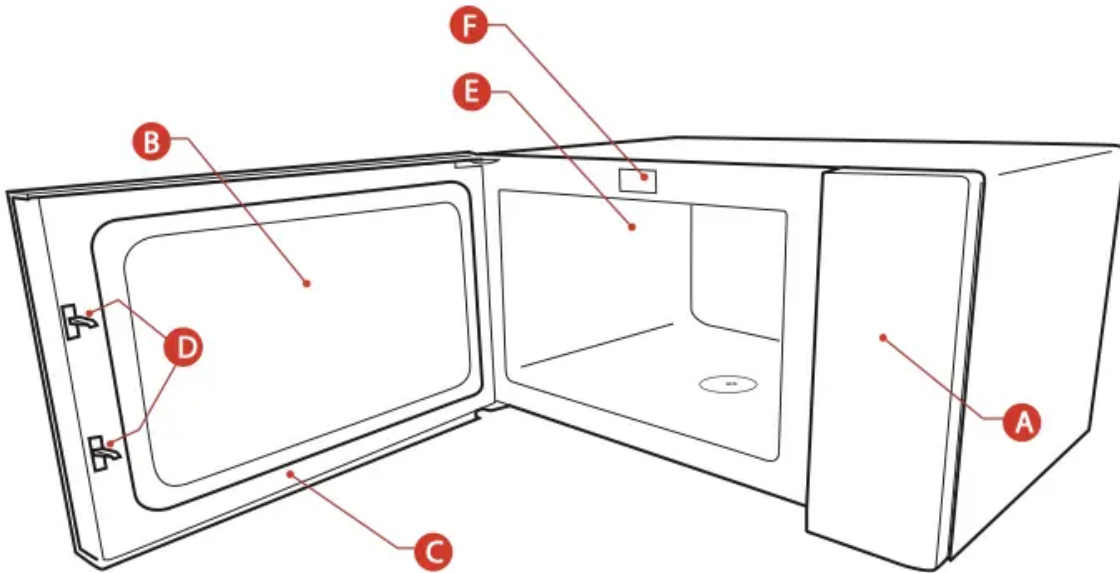

- A. Control panel
- B. Observation window
- C. Door assembly
- D. Safety interlock system
- E. Oven cavity
- F. Preset menu stickers

TURNTABLE INSTALLATION

Clean the cooking compartment and place the turntable.

For new installations, make sure all packaging and shipping tape has been removed from the turntable shaft.

Before using the appliance to prepare food for the first time, you will need to put the turntable in place correctly. You must clean the cooking compartment and accessories. You can also refer them to the cleaning section on 30 page.

How to put the turntable in place:

1. Place the turntable ring assembly ② into the recess in the cooking compartment.

2. Place the glass tray ① on the turntable ring assemblies ② .

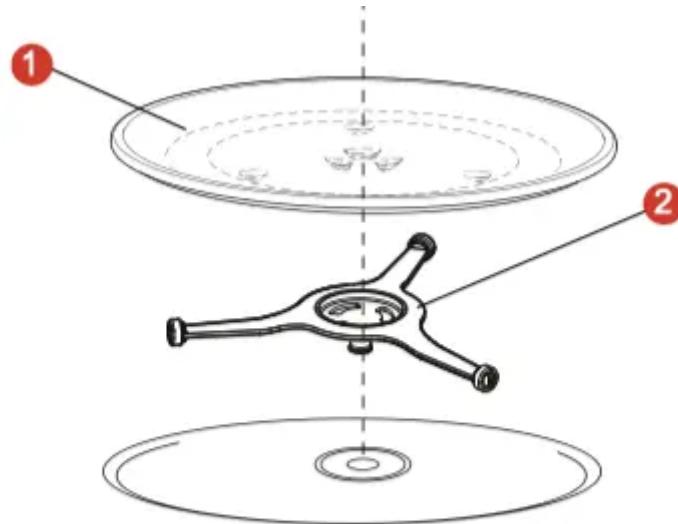

- 1) Glass Tray
- 2) Turntable Ring Assembly

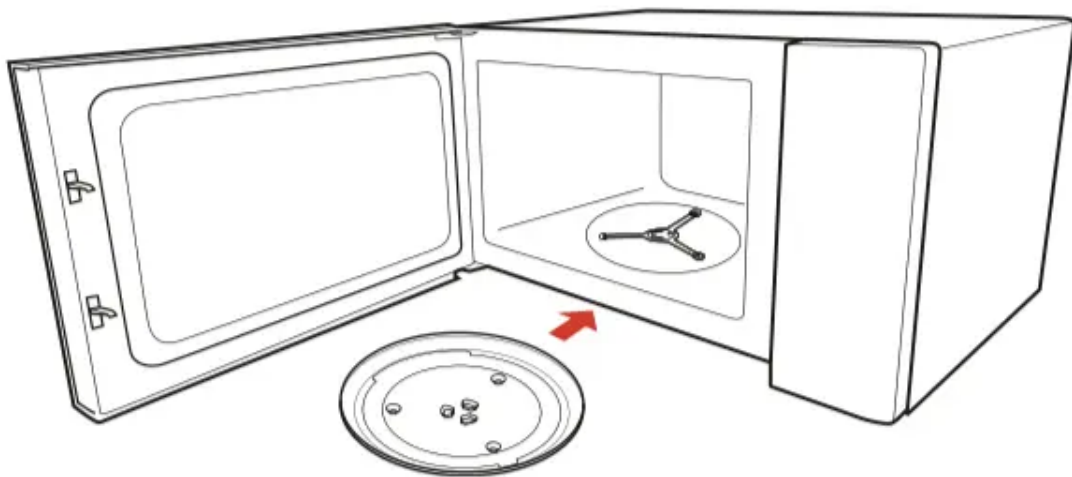

- Never use the appliance without the turntable. Make sure that it is properly engaged. The turntable can turn clockwise or anti-clockwise.
- Never place the glass tray upside down. The glass tray should never be restricted.
- Both glass tray and turntable ring assembly must always be used during cooking.
- All food and containers of food are always placed on the glass tray for cooking.
- Never restrict the movement of the turntable.

- If glass tray or turntable ring assembly cracks or breaks, contact your nearest authorized service center.

COUNTERTOP INSTALLATION

Remove all packing material and accessories. Examine the oven for any damage such as dents or broken door. Do not install if oven is damaged.

Cabinet: Remove any protective film found on the microwave oven cabinet surface. Do not remove the light brown Mica cover that is attached to the oven cavity to protect the magnetron.

INSTALLATION

1. Select a level surface that provide enough open space for the intake and/or outlet vents.
 - a. The minimum installation height is 3.0 ft.
 - b. Leave a minimum clearance of 3.0 inches on each side, 3.0 inches on top and 1.0 inch in the rear.
 - c. Do not remove the legs from the bottom of the oven.
 - d. Blocking the intake and/or outlet openings can damage the oven.
 - e. Operation of microwave oven may cause interference to your radio or TV reception. Please place the oven as far away from radios and TV as possible.

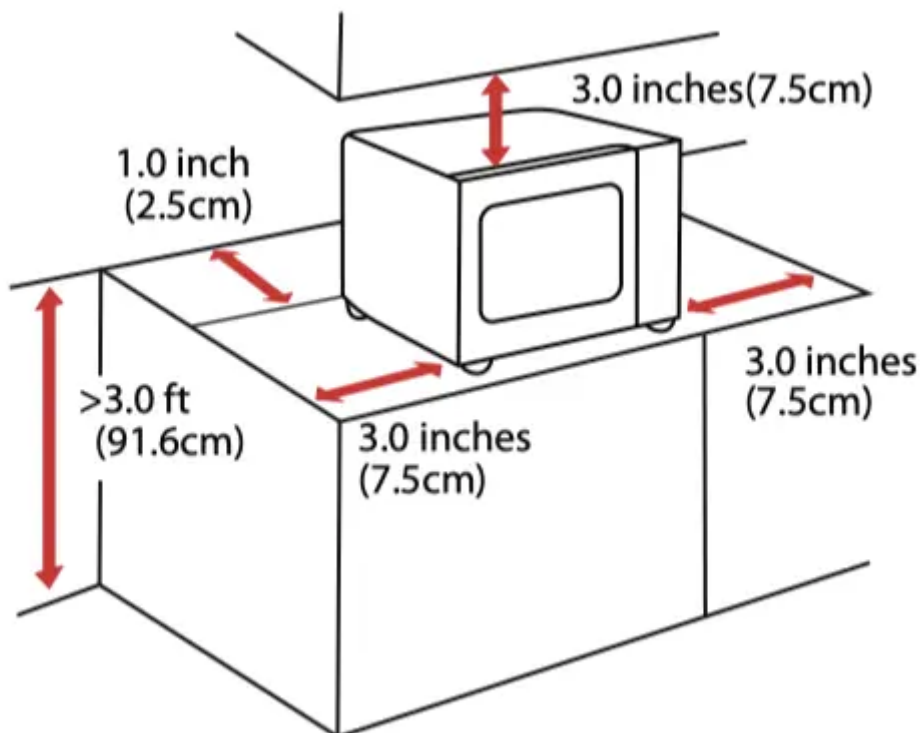

2. Plug microwave oven into a standard household outlet. Be sure the voltage and the frequency is the same as the voltage and the frequency on the rating label.

NOTE

- Do not install oven over a range cooktop or other heat-producing appliance. If installed near or over a heat source, the oven could be damaged and the warranty would be void.

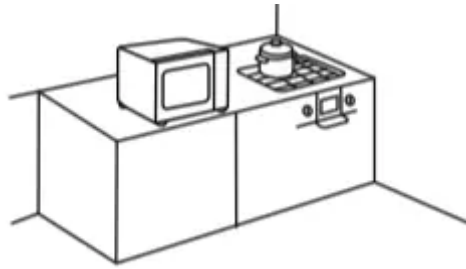

The accessible surface may be hot during operation



INSTRUCTION FOR USE

BEFORE USING FOR THE FIRST TIME

The appliance may produce unpleasant odors when it is used for the first time.

This section tells you what you need to do before using your microwave to prepare food for the first time. Read the section titled "IMPORTANT SAFETY INSTRUCTIONS" beforehand on page 3.

Before you can use your new appliance, you will need to put the turntable in place correctly. You must also clean the cooking compartment and accessories. You can also refer them to the cleaning section on 30 page.









NOTE

- Never use the appliance without the turntable.
- Make sure that it is properly engaged. The turntable can turn clockwise or anticlockwise.
- Fan may continue to operate after cook cycle completes.

OPERATION

CONTROL PANEL AND FEATURES



-  Microwave
-  Broil
-  Convection
-  Pro Defrost
-  Humidity Sensor
-  Auto Menu
-  Child Lock
-  Clock

Temperature Strip



1. POWER LEVELS

Ten power levels are available.

Prior to cooking, press Power and "P100" will display. Then press Power repeatedly to select a different power level. Please refer to page 21 "MICROWAVE COOK" for detailed power level setting.

LEVEL	POWER	DISPLAY
10	100%	P100
9	90%	P90
8	80%	P80
7	70%	P70
6	60%	P60
5	50%	P50
4	40%	P40
3	30%	P30
2	20%	P20
1	10%	P10

2. CLOCK SETTING

When the microwave oven is plugged into an outlet, "0:00" will display.

- a. Press Kit.Timer/Clock twice.



- b. Turn the knob to set the hour figures, it should be within 1-12



- c. Press Kit.Timer/Clock to confirm.



- d. Turn the knob to set the minute figures, it should be within 0-59.



e. Press Kit.Timer/Clock to confirm.



NOTE

- If the numbers entered are not within the range between 1:00 to 12:59, the setting will not be accepted until valid numbers are entered.
- In the process of setting clock, if the STOP/Cancel pad is pressed or if there is no operation within 1 minute, the display will automatically return to the previous clock setting.

3. KITCHEN TIMER

When the microwave oven is plugged into an outlet, "0:00" will display.

a. Press Kit.Timer/Clock once.



b. Turn the knob to set the time, it should be within 0:05-95:00.



c. Press  to start counting down.



NOTE

- The Kitchen Timer setting is different from the Clock setting; it is simply a timer.
- During the Kitchen Timer function, no cooking function can be set into operation.
- Kitchen Timer amount cannot be increased by pressing START/+30S.

- Pressing Stop/Cancel will cancel the Timer countdown.

4. MICROWAVE COOK

When the microwave oven is plugged into an outlet, "0:00" will display.

- Press Microwave repeatedly to choose the power level.



- Press Microwave once, and then turn the knob to set the power level



- Press  to confirm the power level.



- Turn the knob to set the time, it should be within 0:05-95:00.



- Press  to start cooking.



NOTE

Time can be adjusted with different resolution for individual cook time ranges:

- 0---1 min: 5 seconds
- 1---5 min: 10 seconds
- 5---10 min: 30 seconds
- 10---30 min: 1 minute
- 30---95 min: 5 minutes

5. BROIL FUNCTION

a. Press Broil/Convection once.



b. Press  to confirm, G-1 will display.



c. Turn the knob to set the time, it should be within 0:05-95:00.



d. Press  to start cooking.



NOTE

- When half of the time has passed, the buzzer will sound to remind you to turn the food over. If no operation, the oven will continue working.



- Press  to increase the time by 30 seconds.

6. COMBINATION FUNCTION

- Press Combi. repeatedly to choose the mode.



or Press Combi. once, and then turn the knob right to choose the desired mode. C-1 and C-2 are available.



- Press  to confirm



- Turn the knob to set the time, it should be within 0:05-95:00.



- Press  to start cooking.



Combi.mode	Microwave	Broil	Convection
C-1	•		•
C-2	•	•	

7.

CONVECTION WITH PREHEAT

a. Press Broil/Convection repeatedly to set the temperature. "100°F,150°F,250°F,275°F, 300F, 325F, 350°F,375°F" 400°F,425°F are available .



Press Broil/Convection repeatedly twice, "100°F" will display,turn the knob to set the temperature.



b. Press  twice to start preheating. When preheating is completed, The temperature will flash,open the door and place food in the oven.



c. Turn the knob to set the time,it should be within 0:05-95:00.

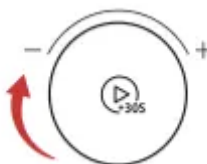

d. Press  to start cooking.



8. CONVECTION WITHOUT PREHEAT

a. Press Broil/Convection repeatedly to set the temperature. "100°F,150°F,250°F,275°F, 300F, 325F, 350°F"375°F" 400°F,425°F are available .



Press Broil/Convection repeatedly twice, "100°F" will display,turn the knob to set the temperature.



b. Press  to confirm the temperature.



c. Turn the knob to set the time,it should be within 0:05-95:00.



d. Press  to start cooking.



9. AUTO MENU

a. In stand-by state, Turn the knob right to set the menu. A01-A06 will display in order.



b. Press  to confirm the menu.



c. Turn the knob to set the weight of the food.



d. Press  to start cooking.



MENU	DISPLAY	WEIGHT/ PORTION	POWER LEVEL
A01 POPCORN	3.2Oz	3.2Oz	P100
	3.5Oz	3.5Oz	
A02 BEVERAGE	4Oz 8Oz 12Oz	4Oz 8Oz 12Oz	P100
A03 SOUP	8Oz 16Oz 24Oz	8Oz 16Oz 24Oz	P100
A04 OATMEAL	28Oz	28Oz	P100/P50
A05 Cake	16Oz	16Oz	350°F(with preheat)
A06 Cookie	7.5Oz	7.5Oz	375°F(with preheat)



10. AIR FRY

- a. Press Air Fry repeatedly to choose the air fry menus.



Press Air Fry once, "H01" will display, and then turn the knob to choose the air fry menus, H01-H10 are available.



- b. Press  to confirm, and then press  again to start cooking.



FOOD	DISPLAY.	WEIGHT/PORTION.
Frozen French Fries	H01	About 11 Oz
Frozen Onion Rings	H02	About 10 Oz
Frozen Chicken nuggets	H03	About 12 Oz
Frozen Chicken wings	H04	About 18 Oz
Frozen Chicken legs	H05	About 27 Oz
Chicken Tenders	H06	About 11 Oz
Frozen Shrimps	H07	About 9 Oz
Fish Sticks	H08	About 12 Oz
Spring Rolls	H09	About 11 Oz
Mozzarella Sticks	H10	About 11 Oz

11. WEIGHT DEFROST

- a. Press Pro Defrost repeatedly to choose the defrost menu

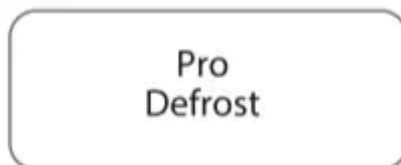

Press Pro Defrost once, "dEF1" will display. and then turn the knob to choose the defrost menu. "dEF1-dEF6" are available.



b. Press  to confirm.



c. Turn the knob to choose the defrost weight, it should be within 4-70Oz



d. Press  to start cooking.



FOOD	LED DISPLAY	WEIGHT RANGE
Vegetables	dEF1	4-70 Oz
Fruit	dEF2	4-70 Oz
Chicken	dEF3	4-70 Oz
Fish	dEF4	4-70 Oz
Meat	dEF5	4-70 Oz
Broth	dEF6	4-70 Oz

Quantity adjustment vary stepwise upon different weight ranges:

4-10 Oz	1 Oz
10-30 Oz	2 Oz
30-66 Oz	3 Oz
66-70 Oz	4 Oz

12. TIME DEFROST

- a. Press Pro Defrost repeatedly to choose the “dEF7”.



Press Pro Defrost once, “dEF1” will display, and then turn the knob to choose the menu “dEF7”.



- b. Press  to confirm



- c. Turn the knob to choose the defrost time, it should be within 0:05-95:00.



- d. Press  to start cooking.



CLEANING

With good care and cleaning, your appliance will retain its appearance and remain fully functioning for a long time to come. We will explain below how you should correctly care for and clean your appliance.

WARNING

- Scratched glass in the appliance door may develop into a crack. Do not use a glass scraper, sharp or abrasive cleaning aids or detergents.
- The surface of the appliance may become damaged if it is not cleaned properly. Microwave energy may escape. Clean the appliance on a regular basis, and remove any food remnants immediately.
- Do not immerse the appliance in water or clean under a jet of water.

Cleaning agent

To ensure that the different surfaces are not damaged by using the wrong cleaning agent, observe the information below. Wash new sponge cloths thoroughly before use.

Do not use:

	Harsh or abrasive cleaning agents
	Metal or glass scrapers to clean the door panels
	Metal or glass scrapers to clean the door seal
	Hard scouring pads or sponges
	Cleaning agents with a high alcohol content

APPLIANCE FRONT

Hot soapy water:

Clean using a dish cloth and then dry with a soft cloth. Do not use metal or glass scrapers for cleaning.

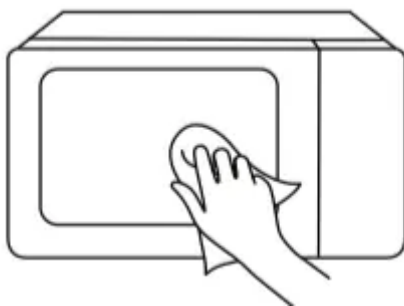

APPLIANCE FRONT WITH STAINLESS STEEL

Hot soapy water:

Clean using a dish cloth and then dry with a soft cloth. Remove splashes and patches of limescale, grease, starch and albumin immediately. Corrosion can form under these patches or splashes. Do not use glass cleaners or metal or glass scrapers for cleaning.

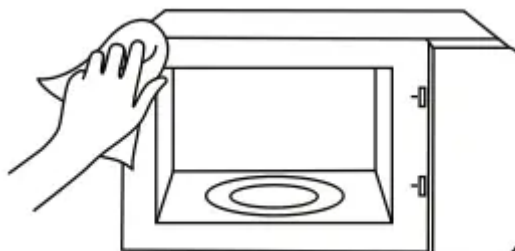

COOKING COMPARTMENT MADE OF STAINLESS STEEL

Hot soapy water or vinegar solution:

Clean using a dish cloth and then dry with a soft cloth. Do not use oven spray or any other aggressive oven cleaners or abrasive materials. Scouring pads, rough sponges and pan cleaners are also unsuitable. These items scratch the surface. Allow the interior surfaces to dry completely.

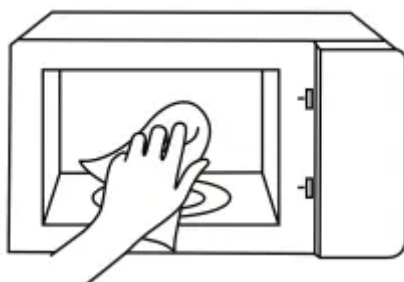

TURNTABLE AND ROLLER RING

Hot soapy water:

When placing the turntable back into position, the glass must engage into the turntable shaft assembly properly.

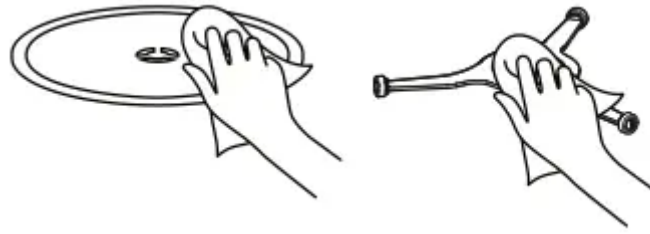

DOOR PANEL

Glass cleaner:

Clean with a dish cloth. Do not use glass scrapers.

MAINTENANCE

TROUBLE SHOOTING

Check your problem by using the chart below and try the solutions for each problem.

If the microwave oven still does not work properly, contact the nearest authorized service center.

TROUBLE	POSSIBLE CAUSE	POSSIBLE REMEDY
Oven will not start	<ul style="list-style-type: none"> a. Electrical cord for oven is not plugged in. b. Door is open. c. Wrong operation is set. 	<ul style="list-style-type: none"> a. Plug into the outlet. b. Close the door and try again. c. Check instructions
Arcing or sparking	<ul style="list-style-type: none"> a. Materials to be avoided in microwave oven were used. b. The oven is operated when empty. c. Spilled food remains in the cavity. 	<ul style="list-style-type: none"> a. Use microwave-safe cookware only. b. Do not operate with oven empty. c. Clean cavity with wet towel.
Unevenly cooked foods	<ul style="list-style-type: none"> a. Materials to be avoided in microwave oven were used. b. Food is not defrosted completely. c. Cooking time, power level is not suitable. d. Food is not turned or stirred. 	<ul style="list-style-type: none"> a. Use microwave-safe cookware only. b. Completely defrost food. c. Use correct cooking time, power level. d. Turn or stir food.
Overcooked foods	Cooking time, power level is not suitable.	Use correct cooking time, power level.
Undercooked foods	<ul style="list-style-type: none"> a. Materials to be avoided in microwave oven were used. b. Food is not defrosted completely. c. Oven ventilation ports are restricted. d. Cooking time, power level is not suitable. 	<ul style="list-style-type: none"> a. Use microwave-safe cookware only. b. Completely defrost food. c. Check to see that oven ventilation ports are not restricted. d. Use correct cooking time, power level

Improper defrosting	<p>a. Materials to be avoided in microwave oven were used.</p> <p>b. Cooking time, power level is not suitable.</p> <p>c. Food is not turned or stirred.</p>	<p>a. Use microwave-safe cookware only.</p> <p>b. Use correct cooking time, power level.</p> <p>c. Turn or stir food.</p>
----------------------------	--	---

PRODUCT SAFETY

PRECAUTIONS TO AVOID POSSIBLE EXPOSURE TO EXCESSIVE MICROWAVE ENERGY

(a). Do not attempt to operate this oven with the door open. Operating with the door open can result in harmful exposure to microwave energy. It is important not to defeat or tamper with the safety interlocks.

(b). Do not place any object between the oven front face and the door or allow soil or cleaner residue to accumulate on sealing surfaces.



(c). Do not operate the oven if it is damaged. It is particularly important that the oven door closes properly and that there is no damage to the:

- (1). DOOR (bent)
- (2). HINGES AND LATCHES (broken or loosened)
- (3). DOOR SEALS AND SEALING SURFACES

(d). The oven should not be adjusted or repaired by anyone except properly qualified service personnel.

SPECIFICATIONS

MODEL	ML2-TC10SAIT(BS)
RATED VOLTAGE	120V~ 60Hz
RATED INPUT POWER(MICROWAVE)	1250W
RATED OUTPUT POWER(MICROWAVE)	1000W
RATED INPUT POWER(BROIL)	1000W
RATED INPUT POWER(CONVECTION)	1800W

NOTE All pictures in this manual are for illustrative purposes only; these may be slightly different from the purchased equipment, please refer to the actual product.

RADIO INTERFERENCE

1. Operation of the microwave oven may cause interference to your radio, TV or similar equipment.
2. When there is interference, it may be reduced or eliminated by taking the following measures:
 - (1).Clean door and sealing surface of the oven.
 - (2).Reorient the receiving antenna of radio or television.
 - (3).Relocate the microwave oven with respect to the receiver.
 - (4).Move the microwave oven away from the receiver.
 - (5).Plug the microwave oven into a different outlet so that microwave oven and receiver are on different branch circuits.

This device complies with part 18 of the FCC Rules.

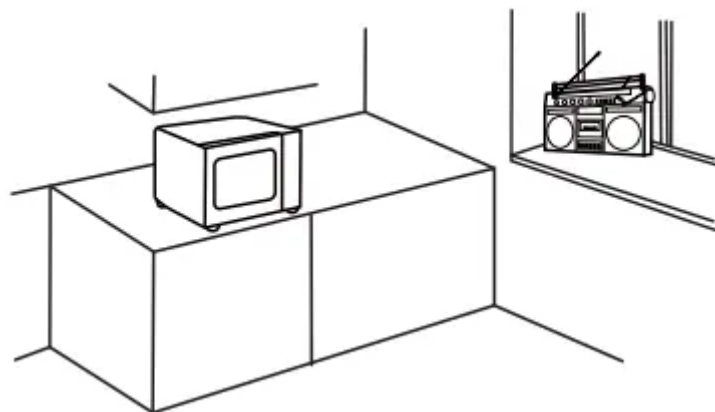

UTENSILS

CAUTION

Personal Injury Hazard:

Tightly-closed utensils could explode. Closed containers should be opened and plastic pouches should be pierced before cooking.

See the instructions on "Materials you can use in microwave oven ." or "Materials can not be used in microwave oven ."

There may be certain non-metallic utensils that are not safe to use for microwaving. If in doubt, you can test the utensil in question following the procedure below.

Utensil Test:

1. Fill a microwave-safe container with 1 cup of cold water (250ml) along with the utensil in question.
2. Cook on maximum power for 1 min.
3. Carefully feel the utensil. If the empty utensil is warm, do not use it for microwave cooking.
4. Do not exceed 1 min cooking time.

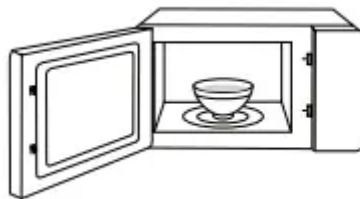





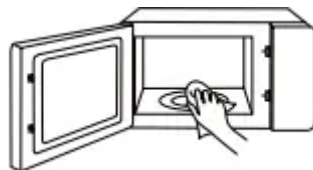





NOTE

KEEP THE CAVITY CLEAN

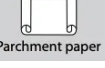







MATERIALS YOU CAN USE IN MICROWAVE OVEN

UTENSILS	REMARKS	
 Browning dish	Follow manufacturer's instructions. The bottom of browning dish must be at least 3/16 inch (5mm) above the turntable. Incorrect usage may cause the turntable to break.	
 Dinnerware	Microwave-safe only. Follow manufacturer's instructions. Do not use cracked or chipped dishes.	
 Glass jars	Always remove lid. Use only to heat food until just warm. Most glass jars are not heat resistant and may break.	
 Glassware	Heat-resistant oven glassware only. Make sure there is no metallic trim. Do not use cracked or chipped dishes.	
 Oven cooking bags	Follow manufacturer's instructions. Do not close with metal tie. Make slits to allow steam to escape.	
 Paper plates and cups	Use for short-term cooking/warming only. Do not leave oven unattended while cooking.	
 Paper towels	Use to cover food for reheating and absorbing fat. Use with supervision for a short-term cooking only.	
 Parchment paper	Use as a cover to prevent splattering or a wrap for steaming.	
 Plastic	Microwave-safe only. Follow the manufacturer's instructions. Should be labeled "Microwave Safe". Some plastic containers soften, as the food inside gets hot. "Boiling bags" and tightly closed plastic bags should be slit, pierced or vented as directed by package.	
 Plastic wrap	Microwave-safe only. Use to cover food during cooking to retain moisture. Do not allow plastic wrap to touch food.	
 Thermometers	Microwave-safe only (meat and candy thermometers).	
	Use as a cover to prevent splattering and retain moisture.	

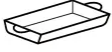

Wax paper

MATERIALS CAN NOT BE USED IN MICROWAVE OVEN

UTENSILS	REMARKS	
 Aluminum tray	May cause arcing. Transfer food into microwave-safe dish.	
 Food carton with metal handle	May cause arcing. Transfer food into microwave-safe dish.	
 Metal or metal trimmed utensils	Metal shields the food from microwave energy. Metal trim may cause arcing.	
 Metal twist ties	May cause arcing and could cause a fire in the oven.	
 Paper bags	May cause a fire in the oven.	
 Plastic foam	Plastic foam may melt or contaminate the liquid inside when exposed to high temperature.	
 Wood	Wood will dry out when used in the microwave oven and may split or crack.	

IMPORTANT SAFETY INSTRUCTIONS

WARNING

To reduce the risk of burns, electric shock, fire, injury to persons or exposure to excessive microwave energy.

When using electrical appliances, basic safety precautions should be followed, including the following.



Read all instructions before using the appliance.



Read and follow the specific:

"PRECAUTIONS TO AVOID POSSIBLE EXPOSURE TO EXCESSIVE MICROWAVE ENERGY" found on page 1.



This appliance must be grounded. Connect only to a properly grounded outlet. See "GROUNDING INSTRUCTIONS" found on page 7.



Install or locate this appliance only in accordance with the provided installation instructions.



As with any appliance, close supervision is necessary when used by children.



When cleaning surfaces of door and oven that comes together on closing the door, use only mild, nonabrasive soaps, or detergent applied with a sponge or soft cloth.

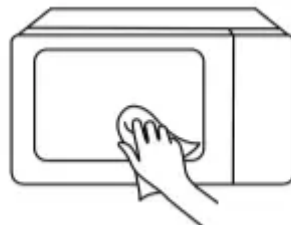

Keep cord away from heated surface.



Liquids, such as water, coffee, or tea are able to overheat beyond the boiling point without appearing to be boiling. Visible bubbling or boiling when the container is removed from the microwave oven is not always present.

THIS COULD RESULT IN VERY HOT LIQUID SUDDENLY BOILING OVER WHEN THE CONTAINER IS DISTURBED OR A UTENSIL IS INSERTED INTO THE LIQUID. To reduce the risk of injury to persons:

1. Do not overheat the liquid.
2. Stir the liquid both before and halfway through heating it.
3. Do not use straightsided containers with narrow necks.
4. After heating, allow the container to stand in the microwave oven for a short time before removing the container.
5. Use extreme care when inserting a spoon or other utensil into the container.

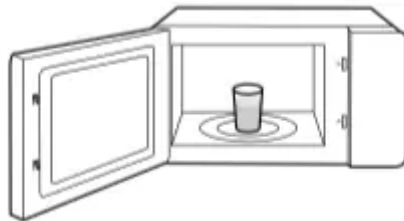

This appliance should be serviced only by qualified service personnel. Contact nearest authorized service facility for examination, repair, or adjustment.



To reduce the risk of fire in the oven cavity:

1. Do not overcook food. Carefully attend appliance when paper, plastic, or other combustible materials are placed inside the oven to facilitate cooking.
2. Remove wire twist-ties from paper or plastic bag before placing bag in oven.
3. If material inside of the oven ignite, keep oven door closed, turn oven off, and disconnect the power cord, or shut off power at the fuse or circuit breaker panel.
4. Do not use the cavity for storage purposes. Do not leave paper products, cooking utensils, or food in the cavity when not in use.



Oversized food or oversized metal utensils should not be inserted in a microwave/toaster oven as they may create a fire or risk of electric shock.

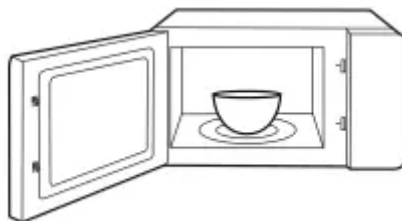



Some products such as whole eggs and sealed containers, for example, closed glass jars are able to explode and should not be heated in this oven.

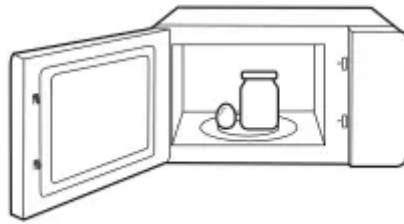

Do not store this appliance outdoors. Do not use this product near water including near a kitchen sink, in a wet basement, near a swimming pool, or similar location.



Do not immerse cord or plug in water or any other liquid.



Use this appliance only for its intended use as described in the manual. Do not use corrosive chemicals or vapors in this appliance. This type of oven is specifically designed to heat, cook or dry food.

It is not designed for industrial or laboratory use.



Do not operate this appliance if it has a damaged cord or plug, if it is not working properly, or if it has been damaged or dropped.



Do not cover or block any openings on the appliance.



Do not clean with metal scouring pads. Pieces can burn off the pad and touch electrical parts involving a risk of electric shock.



Do not let the cord hang over edge of table or counter.



Do not use paper products when appliance is operated in the toaster mode.

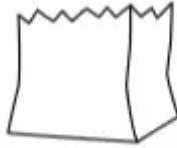

Do not store any materials, other than manufacturer's recommended accessories, in this oven when not in use.



Do not cover racks or any other part of the oven with metal foil. This will cause overheating of the oven.

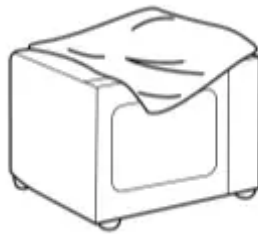

SAVE THESE INSTRUCTIONS

HOUSEHOLD USE ONLY(NOT FOR COMMERCIAL USE)

GROUNDING INSTRUCTIONS

This appliance must be grounded. In the event of an electrical short circuit, grounding reduces the risk of electric shock by providing an escape wire for the electric current. This appliance is equipped with a cord having a grounding wire with a grounding plug. The plug must be plugged into an outlet that is properly installed and grounded.

WARNING - Improper use of the grounding can result in a risk of electric shock. Consult a qualified electrician or serviceman if the grounding instructions are not completely understood, or if doubt exists as to whether the appliance is properly grounded. If it is necessary to use an extension cord, use only a 3-wire extension cord that has a 3-blade grounded plug, and 3-slot receptacle that will accept the plug on the appliance. The marked rating of the extension cord shall be equal to or greater than the electrical rating of the appliance.

DANGER Electric Shock Hazard:

Touching some of the internal components can cause serious personal injury or death. Do not disassemble this appliance.

WARNING Electric Shock Hazard:

Improper use of the grounding can result in electric shock. Do not plug into an outlet until appliance is properly installed and grounded.

1. A short power-supply cord is provided to reduce the risks resulting from becoming entangled in or tripping over a longer cord.
2. Longer cord sets or extension cords are available and may be used if care is exercised in their use.
3. If a long cord or extension cord is used:
 - (1). The marked electrical rating of the cord set or extension cord should be at least as great as the electrical rating of the appliance.
 - (2). The extension cord must be a grounding-type 3-wire cord.
 - (3). The longer cord should be arranged so that it will not drape over the counter top or tabletop where it can be pulled on by children or tripped over unintentionally.

Warning

This content is compiled from multiple sources and is provided for reference purposes only. It may not be complete or fully applicable to all situations. If you are unable to resolve your issue, please contact the product manufacturer or an authorized service provider for official support.

