

USING THE WASHER

Getting started

WARNING: To reduce the risk of fire, electric shock, or injury to persons, read the IMPORTANT SAFETY WARNING INFORMATION before operating this appliance.

Throughout this manual, features and appearance may vary from your model.

Step 1



- Add fabric softener to the fabric softener dispenser. IMPORTANT: For detergent use, see the specific dispenser section in this manual for your model.
- If using detergent packets, add to the Laundry Pack Dispenser cup (on some models) or add to the bottom of the wash basket before adding clothes. We recommend the use of High Efficiency laundry packs such as Tide PODS™ or Gain Flings™.

Step 2



- Loosely add items around agitator or Infusor. Overloading may negatively impact wash performance. See page 16 for suggested loading examples.
- If not using a dispenser, add the manufacturer's recommended amount of detergent to the top of the load after adding clothes. We recommend the use of High Efficiency detergents such as Tide in your energy efficient washer.

Step 3



- Close lid. NOTE: Unit will not start with lid open except on Bulky cycle.
- Select wash cycle.
- Select wash options, including Deep Rinse option when using fabric softener.
- Select options.

Step 4



- Press Start.

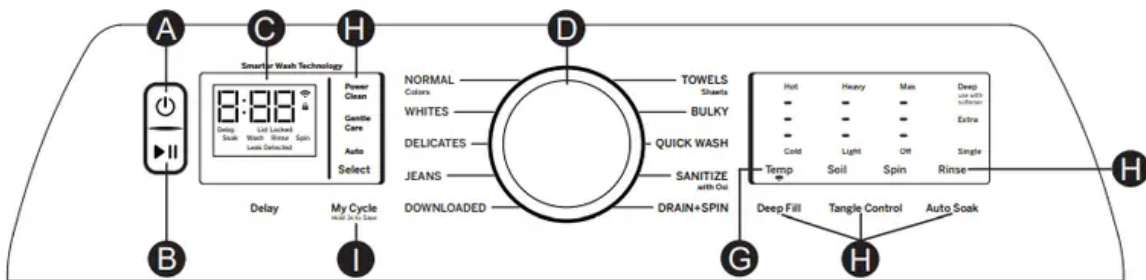
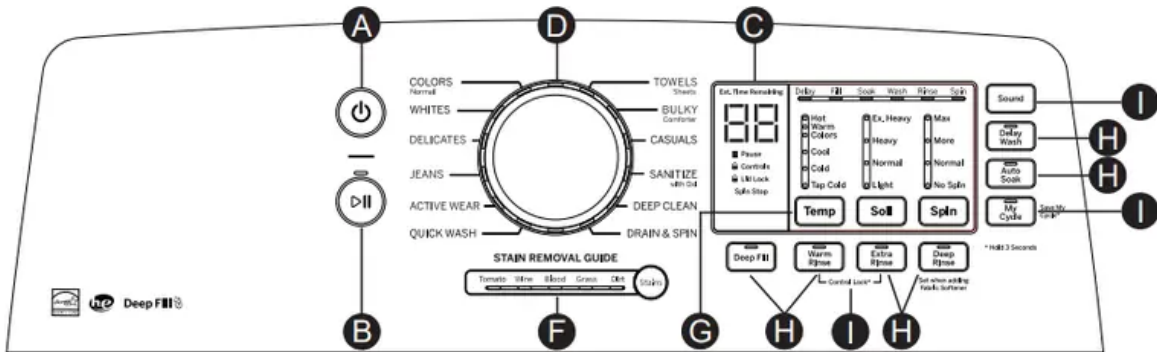
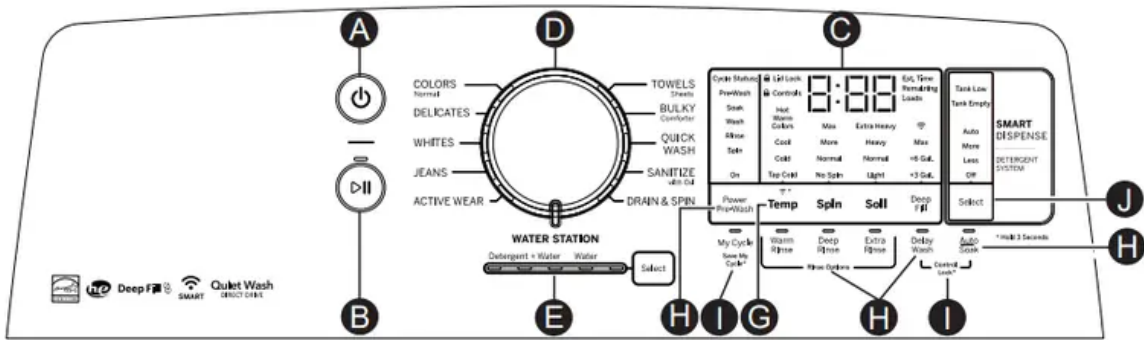

A Power: Press to “wake up” the display. If the display is active, press to put the washer into idle mode. NOTE: Pressing Power does not disconnect the appliance from the power supply.

B. Start/Pause

- Press Start to begin the cycle. NOTE: If the lid is closed, the lid will lock only during the load sensing portion of the cycle (when the Precise Fill selection is made or models which do not have a load size selection) and during spin portions of the cycle. Lid will unlock after load sensing and spin.
- Pressing Pause will unlock the lid (if locked at that time), pause the cycle and the Pause indicator light will blink.
- To continue the cycle, press Start again. If water remains in the machine, select the Drain & Spin cycle to drain basket and spin water out of the washer basket. NOTE: Machine will automatically cancel and drain when water is present and the lid is left open for 15 minutes or the unit is left in a paused state for 24 hours with the lid closed. Select cycle and press Start to begin new cycle.



B Cycle Status Lights

- Shows whether the washer is in the Fill, Soak, Wash, Rinse or Spin portion of the cycle.
- If an out-of-balance condition is detected by the washer, the Spin light will blink during the remaining portion of the cycle and will stay illuminated for a short time after cycle completion. When this occurs, the washer is taking actions to correct the out-of-balance condition and complete the cycle normally. In some cases, the washer may not be able to balance the load and spin up to full speed. If you notice the load is more wet than normal at the end of the cycle, redistribute the load evenly in the wash basket and run a Drain & Spin cycle.

C. Display and Status Lights:

- Display: The display shows the approximate time remaining until the end of the cycle. NOTE: The cycle time is affected by how long it takes the washer to fill. This depends on the water pressure in your home. The size of the load being washed also significantly impacts cycle time, with larger loads taking longer.
- In addition, this display will, “scroll” the washer status:
 - bALAnCINg Start of rebalancing cycle to redistribute clothes. Stops after rebalancing is complete.
 - dELAY When Delay Wash is initiated. Replaced with estimated time when cycle starts.
 - End End of current cycle.
 - FILL “FILL” will scroll across the display during fill. Afterwards the estimated end of cycle time is displayed.
 - H2O SUPPLY Can not sense water level (water supply possibly turned off).
 - LId Cycle stopped because lid is open. Close the lid and press the Start button if needed.
 - SEnSIng Sensing out-of-balance condition, waterproof items, or load size and type before and during fill (normal).
 - PAUSE Cycle paused because the lid was opened during start up sequence or the Start/Pause button was pressed. Press Start button again to restart the cycle.
- Cycle status lights: Shows whether the washer is in the Pre-wash, Delay, Fill, Soak, Wash, Rinse or Spin portion of the cycle. NOTE: Cycle status lights vary by model.
- If an out-of-balance condition is detected by the washer, the Spin light will blink during the remaining portion of the cycle and will stay illuminated for a short time after cycle completion. When this occurs, the washer is taking actions to correct the out-of-balance condition and complete the cycle normally. In some cases, the washer may not be able to balance the load and spin up to full speed. If you notice the load is more wet than

normal at the end of the cycle, redistribute the load evenly in the wash basket and run a Drain & Spin cycle.

- Feature status lights indicate (see sections F and G for more details):



Pause - Will display when washer is paused between cycles.



Controls - The washer is locked - will blink once if you press any button or turn the cycle knob.



Lid Lock - The lid is locked. See the Control Lock description.



WiFi (on some models) - Will display when washer is connected via WiFi. Will blink when you are attempting to connect your device to your home WiFi.

- Spin Stop - Indicates wash basket is coasting to a stop following spin. Lid will not unlock until basket has fully come to a stop

Consumer Help Indicator: Your washer is equipped with Consumer Help Indicator (CHI). CHI is our way to communicate a simple remedy for some situations that you can perform without the need to call for service. The chart below describes the helpful messages you may notice scrolling on your display when you return to start another load. These messages will provide simple remedies you can quickly perform.

- Spin light blinking: If an out-of-balance condition is detected by the washer, the Spin light will blink during the remaining portion of the cycle and will stay illuminated for a short time after cycle completion. When this occurs, the washer is taking actions to correct the out-of-balance condition and complete the cycle normally. In some cases, the washer may not be able to balance the load and spin up to full speed. If you notice the load is more wet than normal at the end of the cycle, redistribute the load evenly in the wash basket and run a Drain & Spin cycle.
- “H2O SUPPLY” (Water not entering washer): Check your house water supply. Did you forget to turn on one or both supply valves after installation or coming back from vacation? As soon as the message starts to scroll, the washer will initiate a 4 minute lockout period. The washer controls won’t respond/change during this time. After the 4 minutes, you can begin your cycle again. If you try to bypass the lock-out period by unplugging the washer, the 4 minute timer will start over again.
- “CAnCELEd”: “CAnCELEd” may scroll on the display if the machine was paused for longer than 24 hours or if the machine has stopped itself before the cycle completed due to certain errors. As soon as the message starts to scroll, the washer will initiate a 4 minute lock-out period. The washer controls won’t respond/change during this time. After

the 4 minute period, you can begin your cycle again. If you try to bypass the lock-out period by unplugging the washer, the 4 minute timer will start over again. If the problem persists, call GE Appliances at 800. GE.CARES (800.432.2737) for service.

- “Lid”: “Lid” will be shown on display if 3 cycles have been started without opening the lid. The washer will not start another cycle until the lid is opened. Try opening, then closing the lid and starting a new cycle. If the problem persists, call GE Appliances at 800.GE.CARES (800.432.2737) for service.

D. Wash Cycles-Cycle Selector Knob - Models GTW720, GTW725, GTW840 and GTW845 only

- The wash cycle controls the type of washing process. The cycle selector knob can be turned in either direction. Turning the knob after starting a cycle will stop the washer and change the cycle/options to the new selection. Press Start to begin the new cycle selection.
- The chart below will help you match the items to be washed with the best wash cycle settings. For optimal performance, select the cycle that most closely matches the items being washed. Selections and options shown in bold are the recommended settings for that cycle. Some cycles and options may not be available on some models.

Items to Wash	Cycle	Wash Temp	Soil Level	Spin Selection (Duration)	Options Available	Cycle Details
Cycle for normal, regular, or typical use for washing up to a full load of normally soiled cotton clothing.	Colors Normal	Hot Warm Colors Cool Cold Tap Cold	Ex. Heavy Heavy Normal Light	Max More Normal No Spin	Stain Removal Guide Warm Rinse Auto Soak Deep Rinse Delay Wash Extra Rinse Power Pre-Wash	Cycle for normal, regular, or typical use for washing up to a full load of normally soiled cotton clothing. Choose the Heavy or Extra Heavy soil level selection and Warm or Hot water temperature selection as appropriate for your clothes load for a higher degree of cleaning. Incorporates multi-stage fills and wash periods to provide optimal fabric care.
Casual clothes, lightly soiled office wear.	Casuals	Hot Warm Colors Cool Cold Tap Cold	Ex. Heavy Heavy Normal Light	Max More Normal No Spin	Stain Removal Guide Deep Fill Warm Rinse Auto Soak Deep Rinse Delay Wash Extra Rinse Power Pre-Wash	Wash cycle tailored to care for casual clothes and office wear items.
Lingerie and special care fabrics with light soil.	Delicates	Hot Warm Colors Cool Cold Tap Cold	Ex. Heavy Heavy Normal Light	Max More Normal No Spin	Stain Removal Guide Deep Fill Warm Rinse Auto Soak Deep Rinse Delay Wash Extra Rinse Power Pre-Wash	Utilizes an extra gentle agitate profile and a low spin speed to provide special care to delicate fabrics. It is recommended to place small or ultra delicate items in mesh bags before washing.
Medium to lightly soiled athletic wear items of technical or synthetic fabrics.	Active Wear	Hot Warm Colors Cool Cold Tap Cold	Ex. Heavy Heavy Normal Light	Max More Normal No Spin	Stain Removal Guide Deep Fill Warm Rinse Auto Soak Deep Rinse Delay Wash Extra Rinse Power Pre-Wash	Cycle designed for care of medium to lightly soiled active wear, athletic wear, and technical fabrics. Incorporates a dual stage wash period to effectively treat body soils and odors.
Small loads of lightly soiled items that are needed in a hurry. Examples include one casual wear outfit or 3 soccer uniforms.	Quick Wash	Hot Warm Colors Cool	Ex. Heavy Heavy Normal Light	Max More Normal No Spin	Stain Removal Guide Deep Fill Warm Rinse Auto Soak Deep Rinse Delay Wash Extra Rinse Power Pre-Wash	Utilizes more intense agitation profile and expedited wash period to clean small lightly soiled loads in the fastest time possible.
Wet load of items. For items that need only to be rinsed, use this cycle with Deep Rinse option.	Drain & Spin			Max More Normal No Spin	Deep Rinse Extra Rinse	Utilizes a high speed spin to extract water from wet items. For items that need to be rinsed, select the Deep Rinse option when using this cycle.
Heavily soiled colorfast items.	Sanitize with Oxi*	Hot	Ex. Heavy	Max More	Warm Rinse Auto Soak Deep Rinse Delay Wash Extra Rinse	Cycle uses an initial lower water fill for super concentrated, high temperature sanitization followed by a heavy wash step. A pump purge and deep rinse is incorporated to remove contaminants. See additional details below. Smart Dispense not available on this cycle.

D Wash Cycles-Cycle Selector Knob - Models GTW720, GTW725, GTW840 and GTW845 only (Continued)



Items to Wash	Cycle	Wash Temp	Soil Level	Spin Selection (Duration)	Options Available	Cycle Details
Jeans with medium to light soil.	Jeans	Hot Warm Colors Cool Cold Tap Cold	Ex. Heavy Heavy Normal Light	Max More Normal No Spin	Stain Removal Guide Deep Fill Warm Rinse Auto Soak Deep Rinse Delay Wash Extra Rinse Power Pre-Wash	Combines higher water levels, a specially designed agitation profile, and multi-step wash to care for jeans with medium to light soil.
Sturdy fabrics with heavy to medium soil.	Deep Clean	Hot Warm Colors Cool Cold Tap Cold	Ex. Heavy Heavy Normal Light	Max More Normal No Spin	Stain Removal Guide Deep Fill Warm Rinse Auto Soak Deep Rinse Delay Wash Extra Rinse Power Pre-Wash	Incorporates multi-step wash periods combined with extended wash periods to effectively clean heavily to medium soiled sturdy fabrics.
Water-resistant, bedding and bulky items, such as large coats, mattress pads, and bath mats.	Bulky	Hot Warm Colors Cool Cold Tap Cold	Ex. Heavy Heavy Normal Light	Max More Normal No Spin	Stain Removal Guide Deep Fill Warm Rinse Auto Soak Deep Rinse Delay Wash Extra Rinse Power Pre-Wash	Provides a Deep Fill/max fill wash water level to wash bulky and waterproof items. Also incorporates a Deep Fill rinse to effectively rinse bulky items and a low spin speed appropriate for these items. Only use this cycle for water-resistant, bedding or bulky items.
Towels Sheets	Towels / Sheets	Hot Warm Colors Cool Cold Tap Cold	Ex. Heavy Heavy Normal Light	Max More Normal No Spin	Stain Removal Guide Deep Fill Warm Rinse Auto Soak Deep Rinse Delay Wash Extra Rinse Power Pre-Wash	Cycle designed washing towels or sheets, using a higher water level to effectively clean these items. It is recommended that towels and sheets be washed separately for best care and washing performance. For waterproof bed covers use Bulky cycle.
Whites and household linens	Whites	Hot Warm Colors Cool Cold Tap Cold	Ex. Heavy Heavy Normal Light	Max More Normal No Spin	Stain Removal Guide Deep Fill Warm Rinse Auto Soak Deep Rinse Delay Wash Extra Rinse Power Pre-Wash	Cycle tailored to clean and brighten your whites.

Failure to follow these instructions may result in injury or property damage.

For Waterproof, Water-Resistant, or Bulky Items:

- Only use the Bulky Items (or Delicates) cycle. **NOTE:** Some models only have a Delicates cycle.
- Using other cycles can cause excessive vibration and may result in injury or damage to the washer, walls, or floor.
- Do not mix waterproof and non-waterproof items.
- Read the Owner's Manual for wash cycle details.

D Wash Cycles-Cycle Selector Knob - Models PTW600 and PTW605 only

- The wash cycle controls the type of washing process. The cycle selector knob can be turned in either direction. Turning the knob after starting a cycle will stop the washer and change the cycle options to the new selection. Press Start to begin the new cycle selection.
- The chart below will help you match the items to be washed with the best wash cycle settings. For optimal performance, select the cycle that most closely matches the items being washed.



- Selections and options shown in bold are the recommended settings for that cycle.
- Some cycles and options may not be available on some models.
- Downloaded: Use with the SmartHQ App to download additional cycles to your washer. Defaults to Active Wear cycle (see cycle table below).

Items to Wash	Cycle	Wash Temp	Soil Level	Spin Selection (Duration)	Options Available	Cycle Details
Cycle for normal, regular, or typical use for washing up to a full load of normally soiled cotton clothing.	Colors Normal	Hot Warm Colors Cool Cold Tap Cold	Heavy Heavy (-) Normal Light (+) Light	Max ++ + Normal Off	Tangle Control Power Clean Gentle Care Extra Rinse Auto Soak Delay Wash	Cycle for normal, regular, or typical use for washing up to a full load of normally soiled cotton clothing. Choose the Heavy or Extra Heavy soil level selection and Warm or Hot water temperature selection as appropriate for your clothes load for a higher degree of cleaning. Incorporates multi-stage fills and wash periods to provide optimal fabric care.
Lingerie and special care fabrics with light soil.	Delicates	Hot Warm Colors Cool Cold Tap Cold	Heavy Heavy (-) Normal Light (+) Light	Max ++ + Normal Off	Auto Soak Deep Fill Delay Wash Extra Rinse Power Clean Gentle Care	Utilizes an extra gentle agitate profile and a low spin speed to provide special care to delicate fabrics. It is recommended to place small or ultra delicate items in mesh bags before washing.
Small loads of lightly soiled items that are needed in a hurry. Examples include one casual wear outfit or 3 soccer uniforms.	Quick Wash	Hot Warm Colors Cool	Heavy Heavy (-) Normal Light (+) Light	Max ++ + Normal Off	Auto Soak Deep Fill Delay Wash Extra Rinse Tangle Control Power Clean Gentle Care	Utilizes more intense agitation profile and expedited wash period to clean small lightly soiled loads in the fastest time possible.
Wet load of items. For items that need only to be rinsed, use this cycle with Deep Rinse option.	Drain & Spin	Hot Warm Colors Cool Cold		Max ++ + Normal Off	Deep Fill Delay Wash Extra Rinse	Utilizes a high speed spin to extract water from wet items. For items that need to be rinsed, select the Deep Rinse option when using this cycle.
Heavily soiled colorfast items.	Sanitize with Oxi*	Hot	Heavy	Max ++ +	Auto Soak Delay Wash Extra Rinse	Cycle uses an initial lower water fill for super concentrated, high temperature sanitization followed by a heavy wash step. A pump purge and deep rinse is incorporated to remove contaminants. See additional details below. Smart Dispense not available on this cycle.
Jeans with medium to light soil.	Jeans	Hot Warm Colors Cool Cold Tap Cold	Heavy Heavy (-) Normal Light (+) Light	Max ++ + Normal Off	Auto Soak Deep Fill Delay Wash Extra Rinse Tangle Control Power Clean Gentle Care	Combines higher water levels, a specially designed agitation profile, and multi-step wash to care for jeans with medium to light soil.



Items to Wash	Cycle	Wash Temp	Soil Level	Spin Selection (Duration)	Options Available	Cycle Details
Water-resistant, bedding and bulky items, such as large coats, mattress pads, and bath mats.	Bulky	Hot Warm Colors Cool Cold Tap Cold	Heavy Heavy (-) Normal Light (+) Light	Max ++ + Normal Off	Auto Soak Delay Wash Extra Rinse Power Clean Gentle Care	Provides a Deep Fill/max fill wash water level to wash bulky and waterproof items. Also incorporates a Deep Fill rinse to effectively rinse bulky items and a low spin speed appropriate for these items. Only use this cycle for water-resistant, bedding or bulky items.
Towels Sheets	Towels / Sheets	Hot Warm Colors Cool Cold Tap Cold	Heavy Heavy (-) Normal Light (+) Light	Max ++ + Normal Off	Auto Soak Deep Fill Delay Wash Extra Rinse Tangle Control Power Clean Gentle Care	Cycle designed washing towels or sheets, using a higher water level to effectively clean these items. It is recommended that towels and sheets be washed separately for best care and washing performance. For waterproof bed covers use Bulky cycle.
Whites and household linens	Whites	Hot Warm Colors Cool Cold Tap Cold	Heavy Heavy (-) Normal Light (+) Light	Max ++ + Normal Off	Auto Soak Deep Fill Delay Wash Extra Rinse Tangle Control Power Clean Gentle Care	Cycle tailored to clean and brighten your whites.
Various specialty fabrics	Down-loaded	Refer to SmartHQ App				Specialty cycles selectable through the SmartHQ App. Defaults to Active Wear.
Medium to lightly soiled athletic wear items of technical or synthetic fabrics.	Active Wear (Down-loaded) Default	Hot Warm Colors Cool Cold Tap Cold	Heavy Heavy (-) Normal Light (+) Light	Max ++ + Normal Off	Auto Soak Deep Fill Delay Wash Extra Rinse Tangle Control Power Clean Gentle Care	Default cycle for the Downloaded cycle position. Cycle designed for care of medium to lightly soiled active wear, athletic wear, and technical fabrics. Incorporates a dual stage wash period to effectively treat body soils and odors.

*Sanitize with Oxi The Sanitize With Oxi cycle, when using an Oxi additive along with your detergent, is designed to remove 99.9% of bacteria found in home laundry. Measure the detergent and the Oxi products carefully. Using the amounts appropriate for a large heavily soiled load in a top load washer, follow the detergent and the Oxi product label instructions. For the Sanitize With Oxi cycle only, add the clothes first and then place the detergent and Oxi product directly on top of the load. The washer hot water supply connection must provide a minimum of 120°F to ensure the effectiveness of this cycle.

NOTE: The default Sanitize With Oxi cycle water temperature can NOT be changed.

E Pretreating or Soaking Using Water Station (on some models)

- This feature is for pretreating of garments only and not intended to serve as an actual wash cycle. When selected, the washer will supply either fresh water or water mixed with detergent from your SmartDispense system for garment hand pre-washing or pre-treating use.
- The pretreating water will be dispensed from the area located in the back of the main opening of the washer. When selected, any water dispensed into the wash tub during the pretreat will be drained from the machine before any subsequently selected wash cycle can begin.



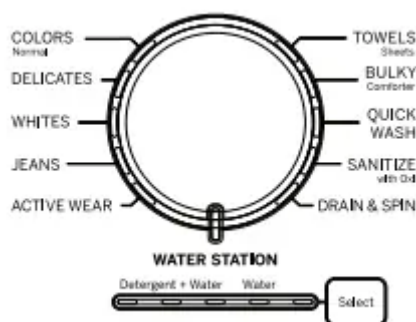

- Alternatively, you can use this feature to soak your garments in the pretreated water for up to 24 hours with the lid closed and the cycle knob remaining on Water Station. In order to use this feature to soak, keep dial on Water Station and close the lid. You can soak for up to 24 hours before the water in the tub will be automatically drained. Rotating the dial, holding the Start button for 3 seconds or leaving the lid open for more than 15 minutes will all automatically drain the water from the tub.

Water Station only

- Select this feature:
 1. Rotate the cycle selection knob to Water Station.
 2. Push the Select button until the LED below Water is illuminated.
 3. Select the desired water temperature using the Temp button.
 4. Press the Start button to initiate the feature.
- If the lid is not already open, raise the lid of the washer to start the flow of fresh water from the dispensing area. Water will continue to be dispensed until the lid is closed or the water level in the tub reaches the maximum level.
- If the lid is closed before the maximum level in the tub is reached, additional water can be dispensed by opening the lid again. Once the lid is closed, water dispensed using the water on demand feature will remain in the tub until the cycle selection knob is rotated to an actual wash cycle, or the Start button is held in for 3 seconds, at which point the water in the tub will be drained out of the machine.
- If the lid is not closed, the water in the tub will automatically be drained after 15 minutes. With the lid closed, if the cycle selection knob is not rotated to an actual wash cycle, or the Start button is not held in for 3 seconds, the water in the tub will automatically be drained after 24 hours.

Water Station with Detergent

- Select this feature:
 1. Rotating the cycle selection knob to the Water Station.
 2. Push the Select button until the LED below Detergent + Water is illuminated.

3. Select the desired water temperature using the Temp button.

4. Press the Start button to initiate the detergent feature.

- If the lid is not already open, raise the lid of the washer to start the flow of soapy water from the dispensing area. Soapy water will continue to be dispensed until the lid is closed or the water level in the tub reaches the maximum level.
- If the lid is closed before the maximum level in the tub is reached, additional soapy water can be dispensed by simply opening the lid again. Once the lid is closed, soapy water dispensed will remain in the tub until the cycle selection knob is rotated to an actual wash cycle, or the Start button is held in for 3 seconds, at which point the soapy water in the tub will be drained out of the machine. If the lid is not closed, the soapy water in the tub will automatically be drained after 15 minutes. With the lid closed, if the cycle selection knob is not rotated to an actual wash cycle, or the Start button is not held in for 3 seconds, the soapy water in the tub will automatically be drained after 24 hours.

F Stain Removal Guide (on some models)

The Stain Removal Guide feature allows you to indicate what stains are on the garments in your load. An initial water fill is performed at a temperature tailored to the stain type selected and to an amount which enables a concentrated cleaning step. A stain scrubbing period, followed by a soak, is conducted to effectively treat the stain. Then additional water is added to the selected temperature and the wash phase is conducted for the cycle selected.

This feature can be applied to most wash cycles as described in the cycle guide.

To use Stain Removal Guide:

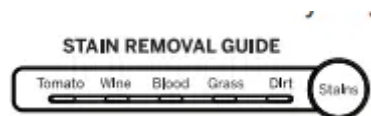

1. Select the desired wash cycle.
2. Press the Stain Removal Guide button. Continue to press to select Tomato stain, Wine stain, Blood stain, Grass stain or Dirt stain. The indicator light will show the selected stain.

To select a different stain, press the Stain Removal Guide button until desired stain to be removed is lit.

To turn off Stain Removal Guide, press until no indicator lights are illuminated.

NOTE: The Soil and Temperature levels will be changed to match the recommended default setting for each stain type. Turning off Stain Removal Guide will return the settings to default

Stain Removal Guide

Category	Recommended Temperatures Treatment/Wash	Stain	For best results, before placing in washer:
Blood	Cold/Cool	Blood Sweat Body Fluids Urine	Rinse in cold water; pretreat stain with liquid detergent or stain remover product.
Grass	Cold/Warm	Grass Lipstick Chocolate Gravy Mayonnaise BBQ Sauce	Pretreat with liquid detergent or stain remover product. Brush lightly; rinse with cold water.
Dirt	Cool/Warm	Dirt Clay Mud	Allow dirt to dry; remove loose dirt using a brush. Rinse with cool water.
Tomato	Cool/Warm	Sauce Catsup Salsa	Pretreat with liquid detergent or stain remover product; rinse with cool water.
Wine	Cool/Warm	Wine Soda Kool-Aid Tea Coffee Juice Beer	Pretreat with mixture of Oxi product and cool water. Add Oxi product along with detergent in the washer.

- Recommended temperatures are optimal for stain removal performance; adjust temperature selection to suit load being washed.
- Ensure stain is completely removed after wash cycle and before placing in dryer; very tough stains may require a second treatment.

G Settings

- Individual settings for water temperature (Temp), agitation (Soil), and spin (Spin) can be set from the minimum (lowest in column) to maximum (highest in column).
- NOTE: Longer Spin times typically reduce dryer time/energy usage (i.e. reduces total energy when using both a washer and a dryer).
- Settings details for models PTW600 and PTW605 only:

Temperature Selection							Soil Selection					Spin Selection				
Tap Cold	Cold	Cool	Colors	Warm	Hot		Light	Light +	Normal	Heavy -	Heavy	Off	Normal	±	++	Max
<input type="radio"/> Hot	<input type="radio"/> Hot	<input type="radio"/> Hot	<input type="radio"/> Hot	<input type="radio"/> Hot	<input type="radio"/> Hot	<input type="radio"/> Hot	<input type="radio"/> Heavy	<input type="radio"/> Heavy	<input type="radio"/> Heavy	<input type="radio"/> Heavy	<input type="radio"/> Heavy	<input type="radio"/> Max	<input type="radio"/> Max	<input type="radio"/> Max	<input type="radio"/> Max	<input type="radio"/> Max
<input type="radio"/> Warm	<input type="radio"/> Warm	<input type="radio"/> Warm	<input type="radio"/> Warm	<input type="radio"/> Warm	<input type="radio"/> Warm	<input type="radio"/> Warm	<input type="radio"/> Heavy -	<input type="radio"/> Heavy -	<input type="radio"/> Heavy -	<input type="radio"/> Heavy -	<input type="radio"/> Heavy -	<input type="radio"/> Off	<input type="radio"/> ++	<input type="radio"/> ++	<input type="radio"/> ++	<input type="radio"/> ++
<input type="radio"/> Colors	<input type="radio"/> Colors	<input type="radio"/> Colors	<input type="radio"/> Colors	<input type="radio"/> Colors	<input type="radio"/> Colors	<input type="radio"/> Colors	<input type="radio"/> Normal	<input type="radio"/> Normal	<input type="radio"/> Normal	<input type="radio"/> Normal	<input type="radio"/> Normal	<input type="radio"/> Off	<input type="radio"/> +	<input type="radio"/> +	<input type="radio"/> +	<input type="radio"/> +
<input type="radio"/> Cool	<input type="radio"/> Cool	<input type="radio"/> Cool	<input type="radio"/> Cool	<input type="radio"/> Cool	<input type="radio"/> Cool	<input type="radio"/> Cool	<input type="radio"/> Light +	<input type="radio"/> Light +	<input type="radio"/> Light +	<input type="radio"/> Light +	<input type="radio"/> Light +	<input type="radio"/> Normal	<input type="radio"/> Normal	<input type="radio"/> Normal	<input type="radio"/> Normal	<input type="radio"/> Normal
<input type="radio"/> Cold	<input type="radio"/> Cold	<input type="radio"/> Cold	<input type="radio"/> Cold	<input type="radio"/> Cold	<input type="radio"/> Cold	<input type="radio"/> Cold	<input type="radio"/> Light	<input type="radio"/> Light	<input type="radio"/> Light	<input type="radio"/> Light	<input type="radio"/> Light	<input type="radio"/> Off	<input type="radio"/> Off	<input type="radio"/> Off	<input type="radio"/> Off	<input type="radio"/> Off
<input type="radio"/> Tap Cold	<input type="radio"/> Tap Cold	<input type="radio"/> Tap Cold	<input type="radio"/> Tap Cold	<input type="radio"/> Tap Cold	<input type="radio"/> Tap Cold	<input type="radio"/> Tap Cold	<input type="radio"/> Light	<input checked="" type="radio"/> Light	<input type="radio"/> Light	<input type="radio"/> Light	<input type="radio"/> Light	<input type="radio"/> Off	<input checked="" type="radio"/> Off	<input type="radio"/> Off	<input type="radio"/> Off	<input type="radio"/> Off

H. Cycle Options

- Deep Fill
 - Select the Deep Fill feature for loads where extra water is desired. The Deep Fill feature is recommended for special case loads only, not for typical use.
 - Press and release the Deep Fill button once before starting the cycle to add 3 additional gallons of water to the wash load.

- Holding the Deep Fill button for 3 seconds will provide the deepest fill level possible; this will increase cycle time due to the additional time it takes to fill the washer.
 - To cancel the option if desired, press the Deep Fill button again.
 - NOTE: The Deep Fill button can also be pressed after the washer has completed filling and is in the wash phase if additional water is desired. To stop the extra fill, press the Deep Fill button again and the water will stop.
- Power Pre-wash (on some models): Ideal for heavily soiled loads, this cycle option works with SmartDispense™ to add a brief wash, soak and drain cycle to loosen and remove heavy soil before starting the cycle selected.
 - Tangle Control™ (on some models): Setting this option will adjust your wash cycle to aid in the prevention of tangling. Your cycle time may increase when this option is selected. NOTE: This option is not allowed for some cycles.
 - Warm Rinse (on some models): Provides a warm rinse to your wash load. Note that rinsing operations may be different with this operation selected in order to effectively apply the warm rinse water to your load.
 - Auto Soak: This option begins with a brief agitation, soaks for a specified period of time, then moves through the rest of the cycle automatically. Repeated pressing of the Soak button will scroll through 15 minute, 30 minute, 1 hour and 2 hour selections and then return back to 0 soak minutes.
 - Deep Rinse: Set this option to provide a deep rinse or when using fabric softener. It may change other settings (e.g. Spin may go to a higher setting) to maximize performance.
 - Delay Wash: When the Delay Wash button is repeatedly pressed, the delay time is set from 1 (01H) to 9 (09H) hours and back to clear (00H) hours. If you press and hold the Delay Wash button for 3 seconds, it will immediately reset.
 - Extra Rinse: When you use extra detergent or bleach to clean heavily soiled clothes, use the Extra Rinse option to better remove additional residues. NOTE: This option is not allowed for some cycles.
 - Smarter Wash Technology (on some models):
 - The Auto setting balances wash performance, fabric care, and cycle time for normally-soiled or lightly-soiled loads.
 - Gentle Care reduces agitation time and adds a series of soaks to reduce fabric wear/fading while still providing great wash performance on garments needing special care.
 - Use Power Clean to add heavy agitation and soaking to boost wash performance for loads needing a deep clean.

I Additional Options

- My Cycle Settings
 - As the cycle selector knob is turned, the Temp, Soil and Spin settings change to automatic pre-set default settings for each cycle. If you desire different default settings, select the desired options or changes to the cycle settings, then press and hold the My Cycle button for 3 seconds to store them. The My Cycle button will light when active. In the future, when you turn the selector knob to that cycle, your settings will be automatically recalled. To restore the factory defaults temporarily (i.e. for this load), press the My Cycle button for 1/2 second. The My Cycle light will turn off and the factory defaults will load. However, the next time you select this cycle, your My Cycle settings will load. If you wish to permanently restore the factory default settings for the cycle; when the My Cycle is active (button light on) press and hold the My Cycle button for 3 seconds. The factory defaults will load for the selected cycle and the My Cycle light will turn off. The default settings will load when this cycle is selected in the future and the My Cycle light will remain off. NOTE: My Cycle saves the following options: Temp, Soil, Spin, Extra Rinse, Deep Fill, Warm Rinse, Auto Soak, Deep Rinse, Tangle Control, Auto, Power Clean, Gentle Care and Stain Removal Guide.
- Sound (on some models): Use the Volume button to change the volume of the end of cycle signal and other system tones. Press the button until you reach the desired volume (high, medium, low) or off.
- Control Lock:
 - Use the control lock before or during a cycle to prevent any selections from being made.
 - To lock/unlock the washer controls, depending on model, press and hold either the Warm Rinse and Auto Soak buttons for 3 seconds or the Rinse and Spin buttons for 3 seconds. The control lock icon will light up when it is on.
 - NOTE: The Power button can still be used when the machine is locked.

J. SmartDispense™ (GTW840 and GTW845 models only)

- When selected, this feature will automatically add detergent to the wash, eliminating the need to add detergent for each load.
- The detergent amount selection on the control panel will default to AUTO when first powering up the washing machine. When AUTO is selected, the amount of detergent needed for each laundry load will automatically be determined based on the size of the load the machine senses.

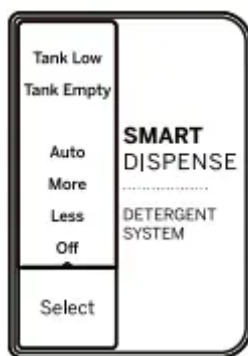

- If it is desired to manually select the amount of detergent for a given load, this can be done by pressing the Select button on the Smart Dispense control panel to choose between Less or More detergent. Less will provide less detergent than the Auto selection and More will provide more detergent than the Auto selection.
- The smart dispense feature can be disabled by pressing the Select button on the Smart Dispense control panel until Off is selected.
- NOTE: Not all cycles will allow the use of the SmartDispense feature. If the Off LED is illuminated and pressing the Select button results in a beeping tone, then SmartDispense is not allowed for the cycle that has been selected. Detergent will need to be added directly to the wash basket for these cycles.
- This model does not have a dispenser drawer for detergent since it has a bulk detergent dispensing system.
- NOTE: If it is desired to manually add detergent for a load, that detergent will need to be added directly to the basket, and the smart dispense set to OFF for that particular load.
- NOTE: The right side of the dispensing area in the rear of the washer opening does NOT pull out. It is a spout only for water and detergent to flow from the smart dispense system.

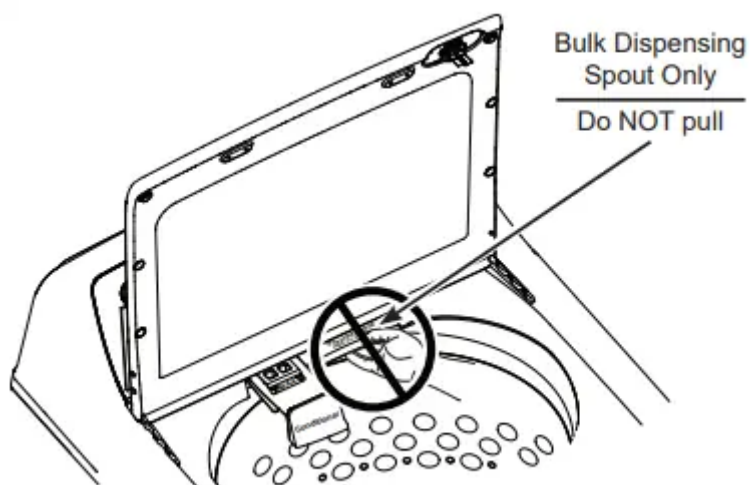

Adding Detergent to SmartDispenser™ (GTW840 and GTW845 models only)

- This machine is equipped with a bulk detergent reservoir that can hold approximately 75 ounces of liquid detergent for your convenience. This is enough detergent for about 50 average laundry loads, depending on what dispense amount is selected.



- When the Tank Low or Tank Empty LED is illuminated, more detergent should be added to the reservoir to ensure detergent will be available for the next cycle.
- The filling port of the detergent reservoir is located on the front left of the washing machine. To fill the reservoir with liquid detergent, first open the tank lid by rotating the small lid clockwise. Then pour LIQUID detergent into the opening until the level reaches the MAX indicator located inside the filling port, also indicated with the horizontal line next to the MAX lettering. Filling to this MAX level will provide detergent for about 50 average laundry loads.
- NOTE: If it is desired to change detergent type in the detergent tank, it is not required to flush the smart dispense system. The new detergent type can be added to a partiallyfilled tank, however it will not be immediately dispensed until the original detergent is completely dispensed from the system.
- NOTE: In the event that excessive chlorine bleach is accidentally spilled or otherwise gets into the detergent tank, please follow the Detergent Tank Clean-Out instructions in the Care and Cleaning section in order to minimize the possibility for clothing damage. If only a few drops of bleach are spilled into the detergent tank, there is no need to flush the tank.

Liquid Fabric Softener/Conditioner Dispenser (GTW840 and GTW845 models only)

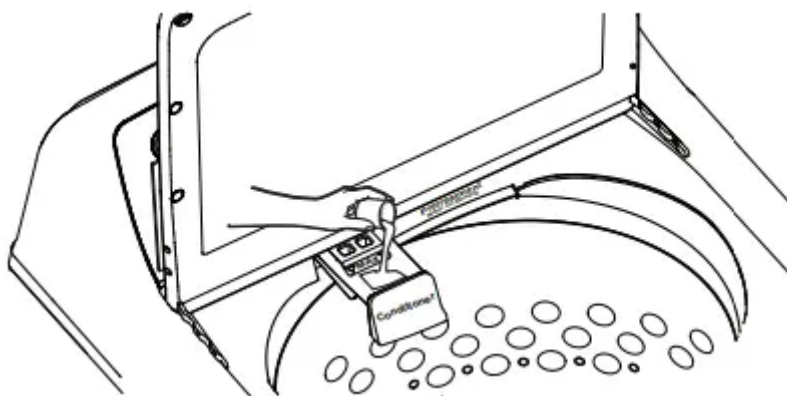

- Liquid fabric softener/conditioner should be added to the small drawer in the rear of the washer opening. Follow the liquid fabric softener/conditioner manufacturer's recommendations for the correct amount of softener/conditioner, based on the load size. Do not overfill or dilute softener/conditioner as this can result in additive being dispensed prematurely in the wash cycle. Your option selections will determine when liquid fabric softener/conditioner is automatically dispensed at its optimal time in the rinse cycle.
- NOTE: Fabric softener crystals should NOT be added to the dispenser drawer, as they will not dispense properly

Liquid Bleach (GTW840 and GTW845 models only)

- Use a measuring cup to pour the bleach into the bleach dispenser. Measure liquid bleach carefully and DO NOT pour directly from the bleach bottle into the bleach dispenser.
- NOTE: The bleach dispenser is a single use dispenser and is NOT a bulk dispense system. The maximum amount of bleach that should be poured into this dispenser for any load should never exceed 1 cup.
- NOTE: In the event that excessive chlorine bleach is accidentally spilled or otherwise gets into the detergent tank, please follow the Detergent Tank Clean-Out instructions in the Care and Cleaning section in order to minimize the possibility for clothing damage. If only a few drops of bleach are spilled into the detergent tank, there is no need to flush the tank.
- NOTE: In the event that detergent is accidentally spilled or otherwise gets into the bleach opening, that detergent will simply be used for the next wash cycle. In this case there is no need to perform any flushing routine.



Flex Dispense Drawer (PTW600 and PT605 models only)

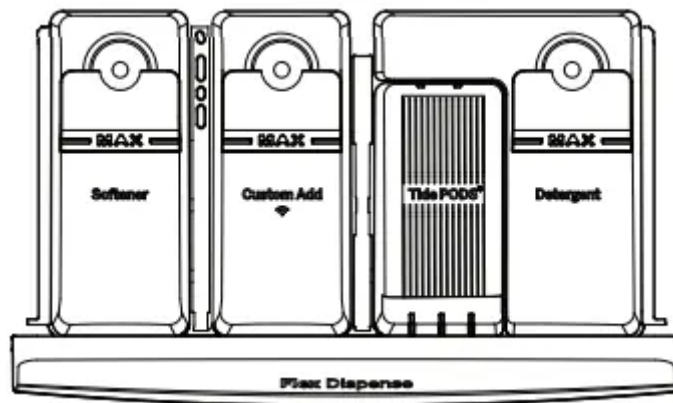

- Use this Flex Dispense Drawer for softener/conditioner, pre-wash detergent, detergent packets (laundry packs) and main detergent.
- Liquid fabric softener/conditioner should be added to the far left washer drawer compartment. Follow the liquid fabric softener/conditioner manufacturer's recommendations for the correct amount of softener/conditioner, based on the load size. Do not overfill or dilute softener/conditioner as this can result in additive being dispensed prematurely in the wash cycle. Your option selections will determine when liquid fabric softener/conditioner is automatically dispensed at its optimal time in the rinse cycle.
- NOTE: Fabric softener crystals should NOT be added to the dispenser drawer, as they will not dispense properly
- Pre-wash detergent should be added to the middle left (second from left) Custom Add compartment. Use with SmartHQ App. Fill for heavily soiled loads to loosen and remove heavy soil before starting the main cycle selected. Refer to the SmartHQ App for Flex Dispense capabilities
- HE detergent should be added to the far right compartment. Follow the detergent manufacturer's recommendations for the correct amount of detergent, based on load size, taking care to add detergent to the right compartment. Do not overfill or dilute detergent as this can result in additive being dispensed prematurely in the wash cycle. Your option selections will determine when detergent is automatically dispensed at its optimal time in the wash cycle.

- For optimal performance, especially when selecting cooler temperature and in cold weather climates, place powdered HE detergent directly on top of the load.
- NOTE: Single-dose laundry packets should not be added to the detergent dispenser, as they will not dispense properly. Put packets in the Laundry Pack Dispenser Cup.
- Detergent packets (Laundry Packs) should be added to the middle right (third from left) compartment. Follow the detergent manufacturer's recommendations for the correct number of detergent packets for your wash load. Do not add more detergent packets than recommended as this can result in residual detergent being leftover at the end of the cycle. Your option selections will determine when detergent is automatically dispensed at its optimal time in the wash cycle.



NOTE: We recommend the use of High Efficiency  laundry packs such as Tide PODS™ or Gain Flings™. Some detergent packs may not dispense completely at very cold temperatures or in the delicate cycle. In these cases, you may use a warmer temperature setting to dispense harder to dissolve detergent packs.

Detergent Dispenser (GTW720 and GTW725 models only)

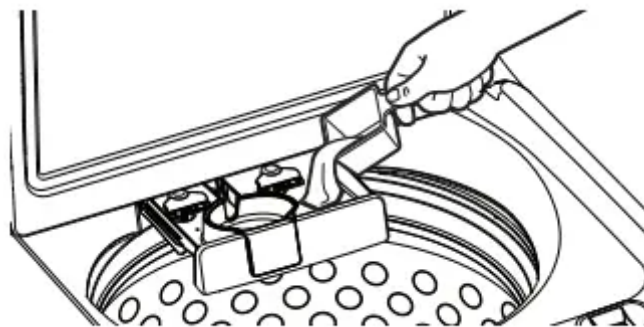

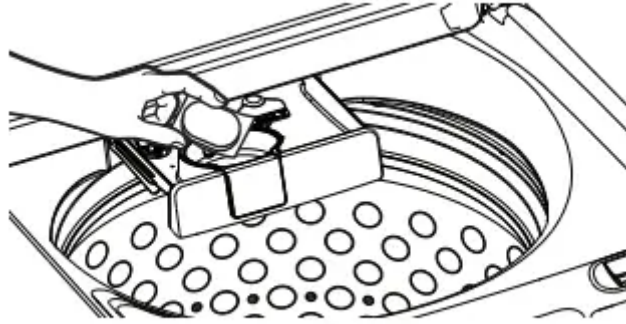

- HE detergent should be added to the right side of the dispenser drawer. Follow the detergent manufacturer's recommendations for the correct amount of detergent, based on load size, taking care to add detergent to the right compartment. Do not overfill or dilute detergent as this can result in additive being dispensed prematurely in the wash cycle. Your option selections will determine when detergent is automatically dispensed at its optimal time in the wash cycle. For optimal performance, especially when selecting cooler temperature and in cold weather climates, place powdered HE detergent directly on top of the load.
- NOTE: Single-dose laundry packets should not be added to the detergent dispenser, as they will not dispense properly. Put packets in the Laundry Pack Dispenser Cup.

Laundry Pack Dispenser (GTW720 and GTW725 models only)



- Detergent packets (Laundry Packs) should be added to the Laundry Pack Dispenser cup. Follow the detergent manufacturer's recommendations for the correct number of detergent packets for your wash load. Do not add more detergent packets than recommended as this can result in residual detergent being leftover at the end of the cycle. Your option selections will determine when detergent is automatically dispensed at its optimal time in the wash cycle.

-  NOTE: We recommend the use of High Efficiency  laundry packs such as Tide PODS™ or Gain Flings™. Some detergent packs may not dispense completely at very cold temperatures or in the delicate cycle. In these cases, you may use a warmer temperature setting or, in rare cases, remove the outer cup to use the secondary, larger chamber to dispense harder to dissolve detergent packs.

Liquid Fabric Softener/Conditioner Dispenser (GTW720 and GTW725 models only)

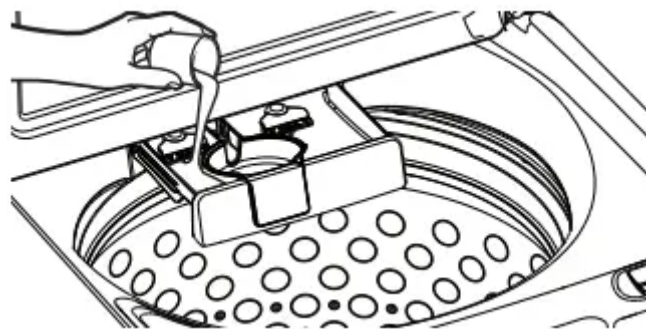

- Liquid fabric softener/conditioner should be added to the left side of the dispenser drawer. Follow the liquid fabric softener/ conditioner manufacturer's recommendations for the correct amount of softener/conditioner, based on load size, taking care to add softener/conditioner to the left compartment. Do not overfill or dilute softener/conditioner as this can result in additive being dispensed prematurely in the wash cycle. Your option selections will determine when liquid fabric softener/conditioner is automatically dispensed at its optimal time in the rinse cycle.

- NOTE: Fabric softener crystals should NOT be added to the dispenser drawer, as they will not dispense properly.

Liquid Bleach Dispenser (PTW600, PTW605, GTW720 and GTW725 models only)

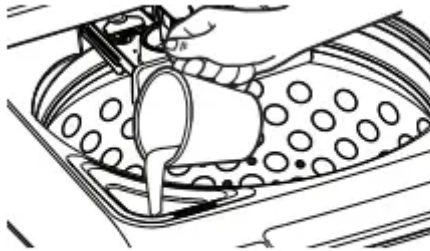

- Liquid chlorine bleach should be added through the bleach dispenser in the front left corner. Follow bleach manufacturer's recommendations for the correct amount of liquid chlorine bleach based on load size, taking care to not apply or spill it directly on clothing.
- NOTE: Do not use liquid chlorine bleach and laundry pretreatments such as an Oxi product in the same wash load

Loading

Always follow fabric manufacturer's care label when laundering.

Automatic Load Sensing

- This determines the appropriate amount of water suited to the size and type of load placed in the washer. The washer will not start the wash cycle or fill with water if the lid is open. When the lid is closed the machine is able to begin filling with water in order to sense the load size.
- NOTE: Automatic Load Sensing initiates a spin at the beginning of the cycle; this is normal operation.
- NOTE: This is a high efficiency washing machine. This system requires less water while providing effective cleaning action. You may notice that the water level is lower than on your previous washer. This is normal for a high efficiency washer

Pretreatment

- Place laundry pretreatments, such as an Oxi product, directly on top of the load of clothes.
- NOTE: Do not use liquid chlorine bleach and laundry pretreatments such as an Oxi product in the same wash load

Proper Use of Detergent

- Using too little or too much detergent is a common cause of laundry problems.
- Use less detergent if you have soft water, a smaller load or a lightly soiled load.
- For spots, apply pre-treatment to items as recommended on the product label. Application should be made in the basket to prevent overspray which may cause the coloring on the lid or graphics to fade.
- Place detergent packets in the Laundry Pack Dispenser (on some models) or the bottom of the wash basket before adding clothes.
- GE Appliances recommends the use of High Efficiency detergents such as Tide PODS™ and liquid detergents in your energy efficient washer. HE detergents are formulated to work with low water wash and rinse systems. HE detergents reduce the oversudsing problems commonly associated with regular detergents.
- When using high efficiency or concentrated detergents, consult the product label to determine amount required for optimum performance. Excessive detergent will negatively impact wash performance.

Sorting Wash Loads

- Sort by color (whites, lights, colors), soil level, fabric type (sturdy cottons, easy care, delicates) and whether the fabric produces lint (terry cloth, chenille) or collects lint (velveteen, corduroy). Wash lint producers such as cotton towels and socks separate from lint collectors including synthetic garments and dress pants.

WARNING - Fire Hazard

- DO NOT wash fabrics soiled with flammable liquids or cleaning solvents. No washer can completely remove oil.
- DO NOT wash or dry anything that has been soaked in or spotted with any type of oil (including cooking oils).
- DO NOT reach into the washer until all moving parts have stopped. Doing so can result in death, explosion, fire or amputation.

Loading the Washer

- Load dry items loosely in the washer basket. For best results, load items evenly and loosely around the outside of the basket, filling in towards the center on larger loads. To add items after washer has started, press Start/Pause if the lid is locked; wait until the Lid Lock indicator on the display is no longer illuminated before attempting to open the lid. Lift the lid and submerge additional items around the outside of the basket. Close the lid and press Start to resume. Adjust load size selection and/or use Deep Fill option if

necessary. NOTE: Some cycles use a two stage wash fill. The first stage will have a lower water level than the second stage; this is normal operation

- Do not place large items such as sheets, blankets and towels across the Infusor. Load them around the outside of the basket.
- Do not put lawn or sofa cushions into the washer as they are too big to move. Remove outer covers and ONLY wash them

Appliance communication

WiFi Connect (For customers in the United States only - on some models)

- Your washer may be GE Appliances WiFi Connect compatible using the optional GE Appliances ConnectPlus module.
- If compatible: To connect this appliance to the internet you will need to purchase a GE Appliances ConnectPlus and attach the module to your appliance through the communication port in the appliance. The GE Appliances ConnectPlus will allow your appliance to communicate with your smartphone for remote appliance monitoring, control and notifications.

Care and cleaning

WARNING - Electrical Shock Hazard: Certain internal parts are intentionally not grounded and may present a risk of electric shock only during servicing. Service personnel – DO NOT contact the following parts while the appliance is energized: Drive Motor, Lid Lock, Water Valves, Drain Pump and Recirculation Pump.

Exterior of the Washer

- Immediately wipe off any spills with a damp cloth.

Interior of the Washer

To clean the interior of the washer, select the Bulky cycle on the control panel. This Bulky cycle should be performed, at a minimum, once per month. This cycle will use more water, in addition to bleach, to control the rate at which soils and detergents may accumulate in your washer.

NOTE: Read the instructions below completely before starting the Bulky cycle.

1. Remove any garments or objects from the washer and ensure the washer basket is empty.
2. Open the washer lid and pour one cup or 250 ml of liquid bleach or other washing

machine cleaner into the basket.



3. Close the lid and select the Bulky cycle. Push the Start button.
4. When the Bulky cycle is working, the display will show the estimated cycle time remaining. Do not interrupt the cycle

IMPORTANT:

- Run Bulky with 1 Cup (250 ml) of bleach once a month.
- After the completion of a Bulky cycle, the interior of your washer may have a bleach smell.

PTW600 and PTW605 models only: For basket cleaning option, download and refer to the SmarthQ App.

Dispenser Drawer

- After some period of use, a small amount of detergent or softener residue may be present in the dispenser drawer. The drawer can easily be removed for cleaning. To remove the drawer, pull it out until the drawer stops and then lift up on the front of the drawer. The drawer can then be removed from the dispenser box. Wash the drawer in warm, soapy water using a mild detergent. Rinse drawer with warm water. If siphon caps are removed for cleaning, be sure to push siphon caps fully back into place after cleaning.
- The dispenser drawer and siphon caps are not dishwasher safe. The dispenser box is not removable, but it can be wiped clean using a damp cloth if necessary. Do not attempt to remove the dispenser box for cleaning.



GTW840 and GTW845 models have a small dispenser drawer with one compartment for softener/conditioner only.



GTW720 and GTW725 models have a large dispenser drawer with compartments for both detergent and softener.

Flex Dispense Drawer (PTW600 and PT605 models only)

- After some period of use, a small amount of detergent or softener residue may be present in the Flex Dispenser Drawer. The drawer can easily be removed for cleaning. To remove the drawer, pull it out until the drawer stops, lift up the back of the drawer on both sides and pull it out. The drawer can then be removed from the dispenser box. Wash the drawer in warm, soapy water using a mild detergent. Rinse drawer with warm water. If siphon caps are removed for cleaning, be sure to push siphon caps fully back into place after cleaning. The dispenser drawer and siphon caps are not dishwasher safe.

- The dispenser box is not removable, but it can be wiped clean using a damp cloth if necessary. Do not attempt to remove the dispenser box for cleaning

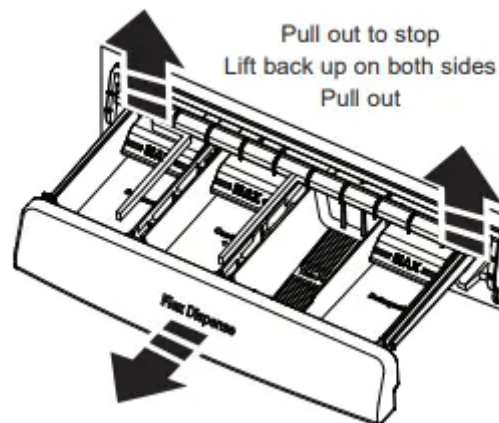

Detergent Tank Clean-Out (GTW840 and GTW845 models only)

NOTE: All clothes should be removed from the washer prior to cleaning out the detergent tank.

To empty out the tank and remove any remaining detergent from the reservoir:

1. Press and hold both the Detergent Dispense and Select buttons for three seconds.
2. The empty out routine will begin with the contents of tank, mixed with water, being dispensed into the basket and consequently drained from the machine at the same time.
3. The empty out routine will continue for approximately 15 minutes unless it is paused by the pressing of the Start button. If tank is initially full, routine may need to be run a second time to empty detergent tank.

NOTE: Optionally, hot water can be added to the tank to aid in flushing out the system of any residual detergent prior to starting or during the cleanout routine.

Water Supply Hoses

- Hoses connecting washer to faucet should be replaced every 5 years.

Long Vacations

- Be sure water supply is shut off at faucets. Drain all water from hoses and water filter pump area if weather will be below freezing

Moving and Storage

- Ask the service technician to remove water from drain pump and hoses. Do not store the washer where it will be exposed to the weather.
- GTW840 and GTW845 models only: Do not move the washer with a full tank of detergent. If moving the washer with a partially filled tank of detergent, do not tilt washer forward as detergent could spill from tank. If moving the washer will result in tipping the

washer forward in any way, it is best to flush out your detergent tank. See Detergent Tank Clean-Out in this Care and Cleaning section.

Installation Instructions

BEFORE YOU BEGIN

Read these instructions completely and carefully.

- **IMPORTANT** – Save these instructions for local inspector's use.
- **IMPORTANT** – Observe all governing codes and ordinances.
- **Note to Installer** – Be sure to leave these instructions with the Consumer.
- **Note to Consumer** – Keep these instructions for future reference.
- **Skill level** – Installation of this appliance requires basic mechanical and electrical skills.
- **Completion time** – 1-3 hours
- **Proper installation** is the responsibility of the installer.
- **Product failure** due to improper installation is not covered under the Warranty.

PARTS SUPPLIED

TOOLS REQUIRED FOR WASHER INSTALLATION

- Pliers
- Level

PARTS REQUIRED (Sold separately)

- Water Hoses (2)
- Rubber Washers (2) and Strainer Screens (2)
- Drain Hose Extension (For discharge heights from 60" - 96")

LOCATION OF YOUR WASHER

DO NOT Install the Washer:

1. In an area exposed to dripping water or outside weather conditions. The ambient temperature should never be below 60°F (15.6°C) for proper washer operation
2. In an area where it will come in contact with curtains or drapes.
3. On carpet. The floor **MUST** be a hard surface with a maximum slope of 1/2" per foot (1.27 cm per 30 cm). To make sure the washer does not vibrate or move, you may have to reinforce the floor.

NOTE: If floor is in poor condition, use 3/4" impregnated plywood sheet solidly attached to existing floor covering.

IMPORTANT: Minimum Installation Clearances - Alcove or Closet

- If your washer is approved for installation in an alcove or closet, there will be a label on the back of the machine describing requirements.
- Minimum clearance between washer and adjacent walls or other surfaces: 0" either side, 2" front, 3" rear. Vertical space from floor to overhead shelving, cabinets, ceiling, etc. = 60".
- Closet doors must be louvered or otherwise ventilated and have at least 60 square inches of open area. If the closet contains both a washer and a dryer, doors must contain a minimum of 120 square inches of open area.

NOTE: The clearances stated on this label are minimums. Consideration must be given to providing adequate clearances for installing and servicing.

WATER SUPPLY REQUIREMENTS

- WATER SUPPLY LINES - Purge Hot and Cold water supply lines for 30 seconds prior to installation of hoses and washing machine. Ensure inlet hose screens are also clean and free of debris.
- WATER PRESSURE - Must be 20 psi minimum to 120 psi maximum.
- WATER TEMPERATURE - Household water heater should be set to deliver water at 120° to 150°F (50° to 66°C) TO THE WASHER when hot wash is selected.
- SHUTOFF VALVES - Both hot and cold shutoff valves (faucets) should be supplied.
- DRAIN - Water should be drained into standpipe. Discharge height MUST NOT BE LESS THAN 30 INCHES, and no more than 8 feet above the base of the washer. Standpipe must be 1-1/2 inches minimum inside diameter and must be open to atmosphere.

1. UNPACKING THE WASHER

- After the machine is in the home, remove outside packing material/carton from washer.
- Remove bag (containing clamp, cable tie and drain hose clip), drain hose and Owner's Reference Guide from tub.
- NOTE: Leave foam shipping material inside tub opening to hold tub in place during the rest of installation

2. REMOVE THE BASE

- Remove base from unit by placing foot on side of base and tipping unit back on corner post. Remove base and bring the washer back upright.

WARNING: Electrical Shock Hazard

- Certain internal parts are intentionally not grounded and may present a risk of electric shock only during servicing.
- Service personnel – DO NOT contact the following parts while the appliance is energized: Drive Motor, Lid Lock, Water Valves, Drain Pump and Recirculation Pump.

3. CONNECT DRAIN HOSE TO WASHER

- Remove the cap from the drain port, if present, before installing the drain hose. It is normal for a small amount of residual water from the factory quality test process to drain out of the port when removing the cap.
- Connect drain hose to drain port on back of washer. Open clamp with pliers and slide onto hose end. Holding clamp open, push hose end onto drain port until fully seated. Release clamp between locating ribs on hose end. Outlet of hose end should be oriented vertically.

4. CONNECT WATER HOSES TO WASHER

- Unplug electrical cord before installing water hoses. If not installed, install rubber washer in one end of hot water hose. Thread hot water hose onto connection labeled H at top rear of washer. Hand tighten and use pliers to tighten hoses between 1/8 and 1/4 turn beyond hand-tight.
- If not installed, install rubber washer in one end of cold water hose C. Thread cold water hose onto connection labeled C at top rear of washer. Hand tighten and use pliers to tighten hoses between 1/8 and 1/4 turn beyond hand-tight.
- Move washer as close to final location as possible leaving room for you to make water, drain, and electrical connections to your home.

5. CONNECT WATER HOSES TO OUTLET VALVES

- Determine which is HOT water line before attaching water hoses to faucets. Traditionally, HOT faucet is on left.
- (If screen washers are not installed) With protruding part of screen toward you, install strainer screen/rubber washer into each of the free ends of two water hoses
- Connect hot water hose to hot water outlet valve of your home. Hand tighten and use pliers to tighten hoses between 1/4 and 1/2 turn beyond hand-tight. Open hot water valve.
- Connect cold water hose to cold water outlet valve of your home. Hand tighten and use pliers to tighten hoses between 1/4 and 1/2 turn beyond hand-tight. Open cold water valve.
- Check for leaks and drips at the hose couplings. Tighten as necessary

6. CONNECT TO DRAIN

- Install drain hose clip on rear panel of washer. Route drain hose through clip and insert free end into drain opening of your home.
- NOTE: If longer drain hose is required, order drain hose extension kit, GE Appliances part number WH49X301. Connect additional drain hose (contained in kit) to original hose with hose clamp (contained in kit).
- If water valves and drain are built into wall, fasten drain hose to one of the water hoses with cable tie provided.
- NOTE: Placing the drain hose too far down the drain pipe can cause a siphoning action. No more than 5" of hose should be in the drain pipe. There must be an air gap around the drain hose. A snug fit can also cause a siphoning action
- If your drain is a standpipe, fasten drain hose to standpipe with cable tie provided.
- NOTE: Placing the drain hose too far down the drain pipe can cause a siphoning action. No more than 5" of hose should be in the drain pipe. There must be an air gap around the drain hose. A snug fit can also cause a siphoning action.
- If drain discharge height does not meet 30" minimum height requirement, end of drain hose must be secured in drain opening of home by installer and have an air gap around hose to prevent siphoning.
- NOTE: Placing the drain hose too far down the drain pipe can cause a siphoning action. No more than 5" of hose should be in the drain pipe. There must be an air gap around the drain hose. A snug fit can also cause a siphoning action.

ELECTRICAL REQUIREMENTS

- Electrical Shock Hazard
 - Plug into a grounded 3-prong outlet.
 - DO NOT remove ground prong.
 - DO NOT use an adapter.
 - DO NOT use an extension cord.
 - Failure to follow these instructions can result in death, fire or electrical shock.
- CIRCUIT – Individual, properly polarized and grounded 15 or 20 amp circuit breaker or time-delay fuse.
- POWER SUPPLY – 2 wire plus ground, 120 Volt, single phase, 60 Hz, alternating current.
- Outlet Receptacle – Properly grounded 3-prong receptacle to be located so the power cord is accessible when the washer is in an installed position. If a 2-prong receptacle is

present, it is the owner's responsibility to have a licensed electrician replace it with a properly grounded 3-prong grounding type receptacle.

- Washer must be electrically grounded in accordance with local codes and ordinances, or in the absence of local codes, with latest edition of the NATIONAL ELECTRICAL CODE, ANSI/NFPA NO. 70 or CANADIAN ELECTRICAL CODE, CSA C22.1. Check with a licensed electrician if you are not sure that the washer is properly grounded.

7. CONNECT POWER AND INSTALL

- Make sure large dial control (on some models) on washer is pushed in to the OFF position.
- Insert plug of electrical cord into a 115V, 15- or 20-amp wall receptacle. Move washer into final position. Place level on flat top side edges of washer. Adjust all four leveling legs until washer is level left-to-right and front-to-back. Remove level.
- Open tub lid. Remove and discard tub shipping material (see Step 1).
- Remove plastic protector sheet from control panel face.

GROUNDING INSTRUCTIONS

- This appliance must be grounded. In the event of malfunction or breakdown, grounding will reduce the risk of electric shock by providing a path of least resistance for electric current. This appliance is equipped with a cord having an equipment- grounding conductor and a grounding plug. The plug must be plugged into an appropriate outlet that is properly installed and grounded in accordance with all local codes and ordinances
- **WARNING:** Improper connection of the equipment grounding conductor can result in a risk of electrical shock. Check with a qualified electrician, or service representative or personnel, if you are in doubt as to whether the appliance is properly grounded. **DO NOT** modify the plug on the power supply cord. If it will not fit the outlet, have a proper outlet installed by a qualified electrician.

If required by local codes, an external 18 gauge or larger copper ground wire (not provided) may be added. Attach to washer cabinet with a #10-16 x 1/2" sheet metal screw (available at any hardware store) to rear of washer as illustrated.

Mobile Home Installation: Installation must conform to Standard for Mobile Homes, ANSI A119.1 and National Mobile Home Construction and Safety Standards Act of 1974 (PL93-383).

FINAL CHECKLIST

Before starting the washer, check to make sure:

- Main power is turned on.
- The washer is plugged in.
- The water faucets are turned on.

- The unit is level and all four leveling legs are firmly on the floor.
- The shipping foam and cardboard are removed.
- The drain hose is properly tied up.
- There are no leaks at the faucet, drain line or washer.
- Remove the cap from the drain port, if present, before installing the drain hose.

Run the washer through a complete cycle.

- Check for water leaks and proper operation.
- Place these instructions in a location near the washer for future reference.

Troubleshooting Tips

... Before you call for service

1. Small amount of water remaining in dispenser (on some models) at end of cycle

- Normal dispenser operation
 - It is normal for a small amount of water to remain in dispenser after the cycle.

2. Short spray or turn on of drain pump and delay after pushing the Start button

- Lid was opened and closed between cycle selection and start
 - This is normal. See START-UP SEQUENCE in the Safety Instructions section.

3. Water level seems low

- This is normal
 - Water may not cover the top level of the clothes. This is normal for this high efficiency washer.

4. Low water flow

- Water valve screens are stopped up
 - Turn off the water source and remove the water connection hoses from the upper back of the washer and the water faucets. Clean both the hose screens (if so equipped) and the screens in the machine using a brush or a toothpick. Reconnect the hoses and turn the water back on. Check to ensure there are no leaks at the connections
- Low water supply pressure
 - If water pressure at the washer inlets is less than 20 psi while the washer is actively filling, call a plumber to assess your water supply and make corrections needed to increase the water pressure.

5. Water siphoning out of washer

- Drain standpipe is too low or hose too far into standpipe
 - The drain hose must exceed 30" height at some point between the washer back and the drain pipe. Use anti-siphon clip. See the Installation Instructions.

6. Too many suds

- Soft water
 - Try less detergent.
- Too much detergent
 - Measure your detergent carefully. Use less soap if you have soft water, a smaller load or a lightly soiled load.
- Type of detergent
 - Switch to High Efficiency detergent such as Tide PODS™ and liquid detergents.

7. Water leaks

- Type of detergent:
 - Switch to High Efficiency detergent such as Tide PODS™ and liquid detergents.
- Using too much detergent in washer:
 - Use less detergent. Use less soap if you have soft water, a smaller load or a lightly soiled load.
- Fill hoses or drain hose is improperly connected:
 - Make sure hose connections are tight at faucets and rubber washers are installed. Make sure end of drain hose is correctly inserted in and secured to drain facility.
- Household drain clogged:
 - Check household plumbing. You may need to call a plumber.
- Drain hose rubs on wall:
 - Make sure drain hose does not make contact with the wall. May cause excessive wear on the hose.
- Constant water pressure to fill hoses at water source
 - Tighten hoses at the faucets. Check condition of the fill hoses; they should be replaced every 5 years.

8. Water temperature seems incorrect

- Cooler water temperatures provide improved energy efficiency:
 - New laundry detergents have been formulated to work with cooler water temperatures without affecting wash performance.
- Water supply is turned off or improperly connected:
 - Turn both hot and cold faucets fully on and make sure hoses are connected to correct faucets. NOTE: Water valves are marked “H” and “C”.
- Water valve screens are stopped up:
 - Turn off the water source and remove the water connection hoses from the upper back of the washer and the water faucets. Clean both the hose screens (if so equipped) and the screens in the machine using a brush or a toothpick. Reconnect the hoses and turn the water back on. Check to ensure there are no leaks at the connections.
- Cool/Cold Water when selecting Hot:
 - This is normal. The washer senses water temperature (on some models) and optimizes for best results. Cold water is added periodically when hot is selected.
- House water heater is not set properly:
 - Make sure house water heater is delivering water at 120°F–140°F (48°C–60°C).

9. Water pumped out before cycle is complete

- Water was left in unit for 24 hours with lid closed or 15 minutes with lid open:
 - Previous cycle has been cancelled. Close lid, select new cycle, and start machine.

10. Water won't drain

- Drain hose is kinked or improperly connected:
 - Straighten drain hose and make sure washer is not sitting on it. Top of drain outlet should be less than 8 ft (2.44 m) above floor.

11. Washer spins and pauses at the beginning of cycles

- This is normal:
 - The washer is sensing the load.

12. Speed changes before during and after spin

- Washer adjusts speeds over several minutes
 - This is normal. The washer will automatically adjust speeds before, during and after the spin cycle to most effectively distribute and spin the wash load

13. Washer pauses during wash cycle

- The Soak Option was chosen:
 - This is normal. The washer alternates between agitate and soak during these cycles to get your clothes cleaner with less wear.
- This is normal:
 - Many cycles incorporate as series of soaks within the agitation period to get your clothes clean with less wear

14. Residual powder in dispenser or clogging of dispensers

- Wash water too cold or low home water pressure
 - Select a warmer wash temperature if possible to improve dissolving of detergent or use liquid detergent. Make sure siphon caps are free of debris and fully pressed into position. Remove and clean tray if clogging occurs

15. Laundry additives dispensing too soon (Dispensers on some models)

- Overfilling of dispensers:
 - Do not overfill or add water to dispenser. Select Deep Rinse option when using fabric softener.

16. Washer pauses during spin cycle



- This is normal:
 - The washer may pause during the spin cycle to remove soapy water more efficiently.

17. Washer won't operate

- Washer is unplugged:
 - Make sure cord is plugged securely into a working outlet.
- Water supply is turned off:
 - Turn both hot and cold faucets fully on.
- Lid is open—safety feature prevents agitation and spinning when lid is up:
 - Close lid and press Start.

- Circuit breaker/fuse is tripped/blown:
 - Check house circuit breakers/fuses. Replace fuses or reset breaker. Washer should have a separate outlet.
- Electronics need to be reset:
 - Unplug washer, wait 2 minutes, plug back in and press Start.
- Start was not pressed
 - Press Start

18. Detergent packets not dissolving in Laundry Pack Dispenser chamber

- Wash water too cold or detergent packet type/ quantity
 -  We recommend the use of High Efficiency  laundry packs such as Tide PODS™ or Gain Flings™.
 - When using delicates cycle, place detergent pack in the bottom of the basket as this will help break down the pack with the gentler agitation. Select a warmer wash temperature, if possible, to improve dissolving of detergent packets.
 - Use the secondary chamber by removing the Laundry Pack Cup (on GTW720 and GTW725 models only).
 - Do not exceed manufacturer's recommended dosing quantity.

19. Unexplained time and/or settings changes

- Changing options (on some models):
 - This is normal. Several options will change other options to maximize washer performance.

20. Basket seems loose

- Basket moves or rotates freely:
 - Washer basket does not have a traditional brake. Washer basket will move freely. This is normal.

21. Colored spots on garments

- Incorrect use of fabric softener
 - Check fabric softener package for instructions and follow directions for using dispenser.
 - Make sure you have selected the Deep Rinse option. (on some models)

- Pretreat stain and rewash using Speed Wash cycle before drying. (on some models)
- Dye transfer: Sort whites or lightly colored items from dark colors.

22. Grayed or yellowed clothes

- Detergent amount:
 - Be sure to follow detergent manufacturer's directions.
- Hard water:
 - Use a water conditioner or install a water softener.
- Water is not hot enough:
 - Make sure water heater is delivering water at 120°F–140°F (48°C–60°C).
- Washer is overloaded:
 - Loosely load clothes no higher than the top row of holes in the washer basket. For best results, load items around the outside of the basket.
- Dye transfer:
 - Sort clothes by color. If fabric label states wash separately, unstable dyes may be indicated.

23. Lint or residue on clothes

- Clothes are air or line dried:
 - If you do not dry your clothes with a clothes dryer, your clothes may retain more lint.
- Incorrect sorting:
 - Separate lint producers from lint collectors.
- Washing too long:
 - Wash small loads for a shorter time using Light Soil setting.
- Detergent not dissolving:
 - Rewash; next time: Try a liquid detergent Use warmer water temperature.
- Overloading:
 - Loosely load clothes in the washer basket. For best results, load items around the outside of the basket.
- Incorrect use of fabric softener:
 - Check fabric softener package for instructions and follow directions for using dispenser.

- Make sure you have selected the Deep Rinse option. (on some models)

24. Clothes too wet

- No spin selected
 - Select a spin option.
- Incorrect cycle selected:
 - Make sure the cycle selected matches the load you are washing. Some fabrics will feel wetter when rinsed with cold water.
- Wash load out of balance:
 - Redistribute load in washer and run through Drain & Spin cycle.

25. Blinking Spin light or Spin light on at end of cycle

- Out of balance condition has been detected
 - Allow cycle to continue and finish.
 - If load is wet at the end of the cycle, even out load and run a Drain & Spin cycle.

26. Snags, holes, tears, rips or excessive wear

- Pins, snaps, hooks, sharp buttons, belt buckles, zippers and sharp objects left in pockets
 - Fasten snaps, hooks, buttons and zippers.
 - Remove loose items like pins, objects in pockets and sharp buttons.
 - Turn knits (which snag easily) inside out.
- Undiluted chlorine bleach:
 - Check bleach package instructions for proper amount. Never add undiluted bleach to wash or allow clothes to come in contact with undiluted bleach.
- Chemicals like hair bleach or dye, permanent wave solution:
 - Rinse items that may have chemicals on them before washing. Use Speed Wash cycle with Extra Rinse option. (on some models)

27. Wrinkling

- Incorrect wash and dry cycles:
 - Match Cycle selection to the type of fabric you are washing (especially for easy care loads).
- Improper sorting:
 - Avoid mixing heavy items (like jeans) with light items (like blouses). Try a fabric softener.

- Overloading:
 - Loosely load clothes in the washer basket.
- Repeated washing in water that is too hot:
 - Wash in warm or cold water.

Sounds

1. “Clicking”

- Shifter mechanism is engaging or disengaging:
 - The drive system will engage at the start of agitate and disengage when agitate is complete. This occurs multiple times during the wash.

2. Back and forth “swoosh”

- Electric motor reversing direction:
 - This sound is the motor rotating back and forth to clean your laundry.

3. “Clicking” behind Control during fill

- Automatic Temperature Control Valve:
 - Two valves mix cold and hot water. The “clicking” is when either valve turns on or off to raise or lower the fill water temperature.

4. Water flow changes during fill

- Automatic Temperature Control Valve:
 - Two valves mix cold and hot water. The “clicking” is when either valve turns on or off to raise or lower the fill water temperature.

5. Motor sounds during spin

- Motor ramping up/down during spin cycle:
 - The motor will speed up incrementally during the spin cycle. When spin is complete, it will coast until it stops.

6. “Humming”

- Water drain pump:
 - The drain pump will make a humming sound when pumping out water after agitation stops and continue until spin is complete.
- Drive motor:
 - The drive motor will make a “humming” sound during the wash and spin phases of the cycle.

7. “Gurgling”

- Water drain pump:
 - When the pump starts drawing in air, It starts to gurgle. The washer should then begin spinning and the sound will continue until it is done spinning.

8. Water “swishing”

- Washing process:
 - Water swishing while the unit is agitating is normal, especially with smaller loads.

9. Washer rocking/ moving

- Washer leveling legs uneven:
 - To level the washer, adjust the leveling legs by rotating the individual leg in the proper direction for up or down.

10. “Squeaking” sound

- Washer not level and rubbing on cabinet:
 - To level the washer, adjust the leveling legs by rotating the individual leg in the proper direction for up or down.

Warning

This content is compiled from multiple sources and is provided for reference purposes only. It may not be complete or fully applicable to all situations. If you are unable to resolve your issue, please contact the product manufacturer or an authorized service provider for official support.