

PYLE User manual

Model: PDWR55BTRFB, PDWR55BTRFW

Dual 5.25" Wall-Mount Marine Speakers. Active Powered Speaker System. Indoor/Outdoor Water Resistant Speakers

PDWR65BTRFB, PDWR65BTRFW

Dual 6.5" Wall-Mount Marine Speakers. Active Powered Speaker System. Indoor/Outdoor Water Resistant Speakers

WALL MOUNT SPEAKER MODELS

Model	Color	Speaker Size	Built-in Wireless BT Streaming	Marine Grade	MAX Power	RMS Power
PDWR55BTRFB	Black	5.25"	✓	✓	800	400
PDWR55BTRFW	White	5.25"	✓	✓	800	400

PDWR55BTRFB-Black Features:

Features:

- + Includes (2) Active Speakers
- + Wireless BT Streaming Music Streaming
- + Digital Audio Power GX Sound Processing Amplifiers
- + 2-Way Full Range Stereo Sound with Bass Reflex
- + Rugged Marine Grade Water-Resistant Construction
- + Integrated Wireless RF Audio Module Streaming Ability
- + Selectable Radio Frequency Switches to Connect Additional Systems
- + Gold Plated Binding Post Speaker Plugs
- + Aux (RCA) Input Jacks
- + Connect & Stream Audio from External Devices
- + Custom Tooled Design for High Power & Deep Bass Response
- + Heavy Duty Cabinet Enclosures
- + Built-in Capacitor Speaker Protection
- + Stain Resistant & Rust Proof Speaker Grills
- + Integrated Wired Power Cable
- + Adjustable Rotary Volume Controls
- + Universal & Detachable Wall-Mount Brackets
- + For Indoor / Outdoor Use with Audio Monitor. Surround Sound Applications
- + Water & Weather-Resistant Design for the Boat or Backyard



What's in the Box:

- (1) 5.25" Active Master Speaker
- (1) 5.25" Active Support Speaker
- Audio Connection Cable (AUX-RCA) 6' ft.

Built-in BT Wireless Audio Streaming :

- Simple Setup & Hassle-Free Pairing Ability
- Instantly Stream Wireless Music from Your Connected Device
- Works with All of Your Favorite Devices
- (iPhone, Android, Smartphone, iPad, Tablet, PC, etc.)
- LED Connection Indicator Light
- Wireless BT Streaming Network Name:"PYLE Audio"
- Wireless Range: 100'+ Ft.

PDWR55BTRFB-Black Features:**Features:**

- Includes (2) Active Speakers
- Wireless BT Streaming Music Streaming
- Digital Audio Power GX Sound Processing Amplifiers
- 2-Way Full Range Stereo Sound with Bass Reflex
- Rugged Marine Grade Water-Resistant Construction
- Integrated Wireless RF Audio Module Streaming Ability
- Selectable Radio Frequency Switches to Connect Additional Systems
- Gold Plated Binding Post Speaker Plugs
- Aux (RCA) Input Jacks
- Connect & Stream Audio from External Devices
- Custom Tooled Design for High Power & Deep Bass Response
- Heavy Duty Cabinet Enclosures
- Built-in Capacitor Speaker Protection
- Stain Resistant & Rust Proof Speaker Grills
- Integrated Wired Power Cable
- Adjustable Rotary Volume Controls
- Universal & Detachable Wall-Mount Brackets
- For Indoor / Outdoor Use with Audio Monitor, Surround Sound Applications
- Water & Weather-Resistant Design for the Boat or Backyard

What's in the Box:

- (1) 5.25" Active Master Speaker
- (1) 5.25" Active Support Speaker
- Audio Connection Cable (AUX-RCA) 6' ft.

Built-in BT Wireless Audio Streaming :

- Simple Setup & Hassle-Free Pairing Ability
- Instantly Stream Wireless Music from Your Connected Device
- Works with All of Your Favorite Devices
- (iPhone. Android. Smartphone. iPad. Tablet. PC. etc.)
- LED Connection Indicator Light
- Wireless BT Streaming Network Name:"PYLE Audio"
- Wireless Range: 100'+ Ft.

Technical Specs:

- Marine Grade IP-X4 Rating
- 5.25" Long Throw Woofers
- MAX Power Output: 240 Watt
- RMS Power Output: 40 Watt + 40 Watt
- 0.5" Neodymium PEI Dome Tweeters
- Magnet Size: 10 oz.
- Cone Material: PP Mica + Rubber Surround
- Frequency Response: 80Hz-20kHz
- 8 Ohm Impedance
- Power: 110/240V
- Single Speaker Dimensions (L x W x H): 7.3" x 6.3" x 9.6" -Each
- Single Speaker Weight: Master Speaker 5.50 lbs. (Slave Speaker 5.05 lbs.)
- Weight : 11.2 lbs.

WALL MOUNT SPEAKER MODELS:

Model	Color	Speaker Size	Built-in Wireless BT Streaming	Marine Grade	MAX Power	RMS Power
PDWR65BTRFB	Black	6.5"	✓	✓	1000	500
PDWR65BTRFW	White	6.5"	✓	✓	1000	500

PDWR65BTRFB-Black

Technical Specs:

- Marine Grade IP-X4 Rating
- 6.5" Long Throw Woofers
- MAX Power Output: 300 Watt
- RMS Power Output: 60 Watt + 60 Watt
- 1.0" Neodymium PEI Dome Tweeters
- Magnet Size: 12 oz.
- Cone Material: PP Mica + Rubber Surround
- Frequency Response: 80Hz-20kHz
- 8 Ohm Impedance
- Power: 110/240V
- Single Speaker Dimensions (L x W x H): 8.4" x 7.5" x 12.1" -Each
- Single Speaker Weight: Master Speaker 7.30 lbs. (Slave Speaker 6.60 lbs.)
- Weight : 14.5 lbs.

PDWR65BTRFW-White**Technical Specs:**

- Marine Grade IP-X4 Rating
- 6.5" Long Throw Woofers
- MAX Power Output: 300 Watt
- RMS Power Output: 60 Watt + 60 Watt
- 1.0" Neodymium PEI Dome Tweeters
- Magnet Size: 12 oz.
- Cone Material: PP Mica + Rubber Surround
- Frequency Response: 80Hz-20kHz
- 8 Ohm Impedance
- Power: 110/240V
- Single Speaker Dimensions (L x W x H): 8.4" x 7.5" x 12.1" -Each
- Single Speaker Weight: Master Speaker 7.30 lbs. (Slave Speaker 6.60 lbs.)
- Weight : 14.5 lbs.

UNLIMITED SLAVE SPEAKER (A2, A3, A4.....) CONNECTION QUANTITY AS LONG AS THEY ARE WITHIN 30M OF RADIUS AWAY FROM MASTER SPEAKER (A1)

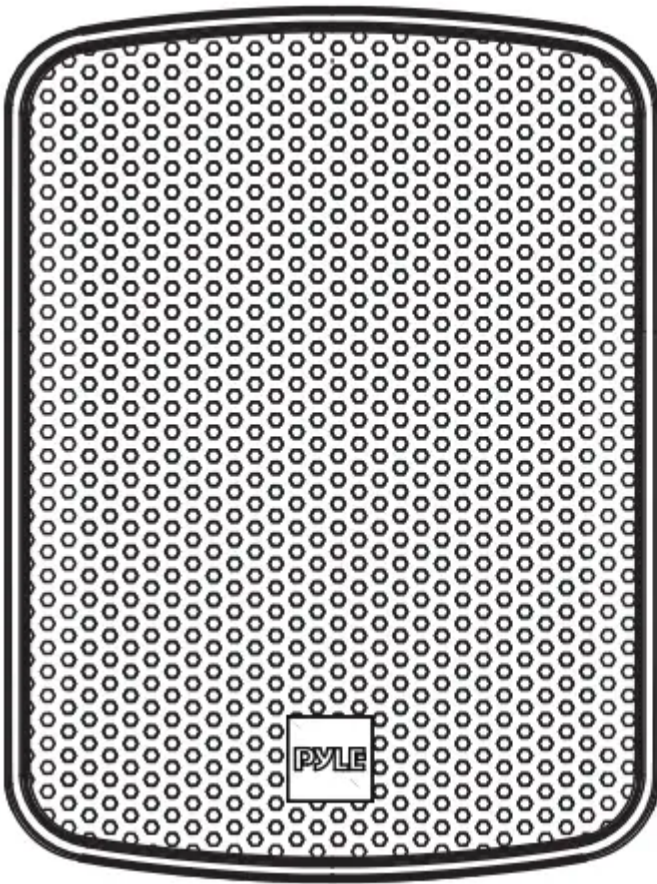

A1 Master

With Amplifier,
Wireless BT &
RF TX

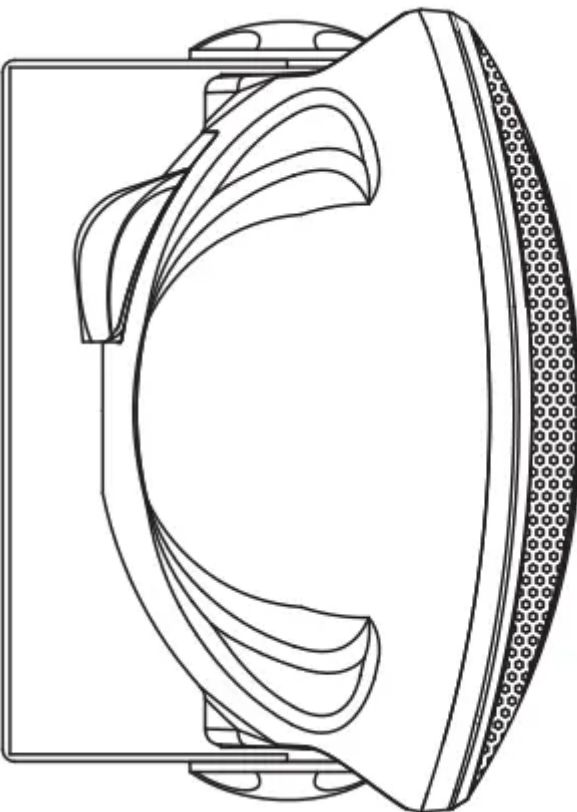

A2 Slave

With Amplifier,
Wireless BT &
RF RX

A4
Slave
With Amplifier,
Wireless BT &
RF RX

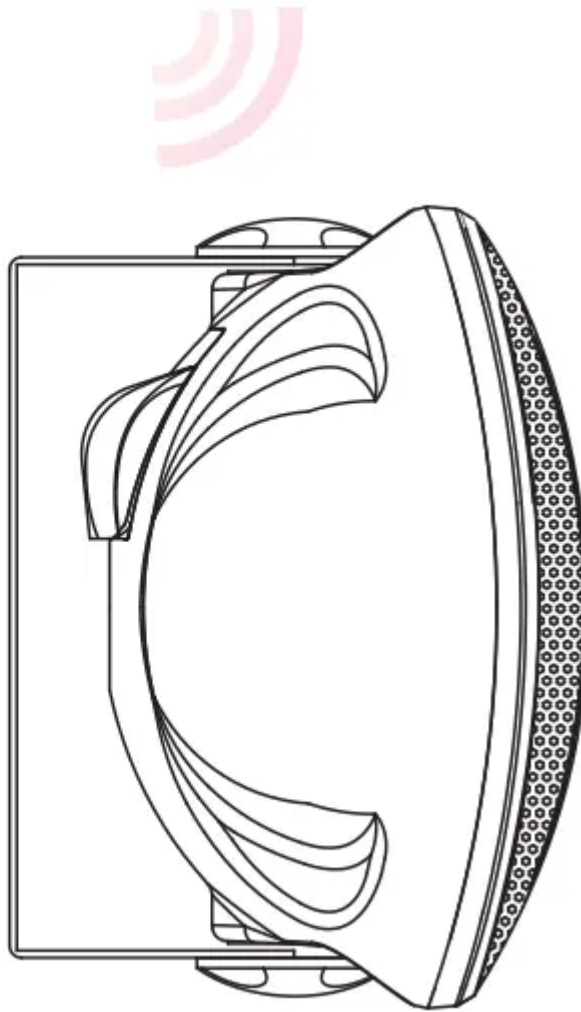

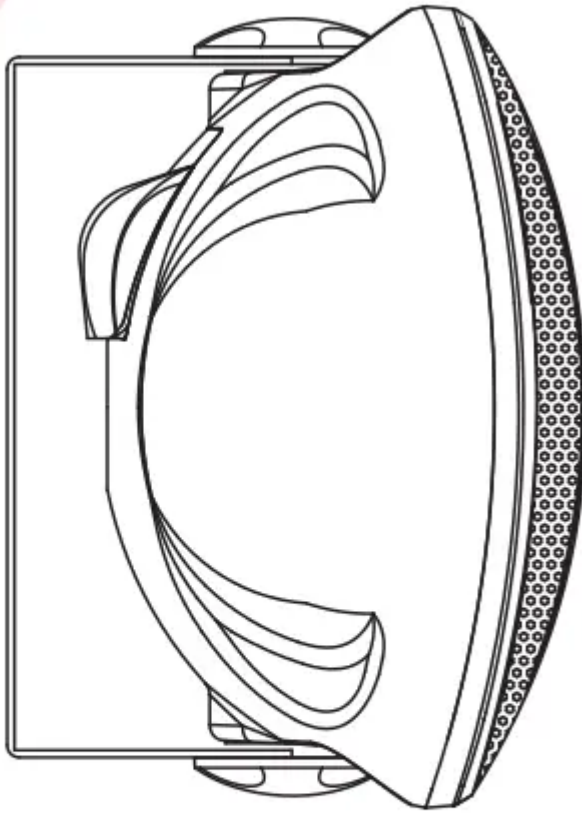

A3 Slave

With Amplifier,
Wireless BT &
RF RX

A4 +A5+A6..... UNLIMITED SPEAKER CONNECTION

LED INDICATOR

Status	Master	Slave
POWER ON	RED	RED
RF CONNECTION (Shake Hand Between Master & Slave Speakers)	RED	BLUE
Wireless BT Streaming CONNECTION (RF was Connected)	BLUE	BLUE
RCA LINE IN (RF was Connected)	RED	BLUE

WIRELESS BT STREAMING CONNECTION

Please be sure the Wireless BT Streaming is turned on at your device. When the device is in BT range, it will connect BT automatically and will be disconnected automatically when it is out of BT range.

OVERALL DIMENSIONS

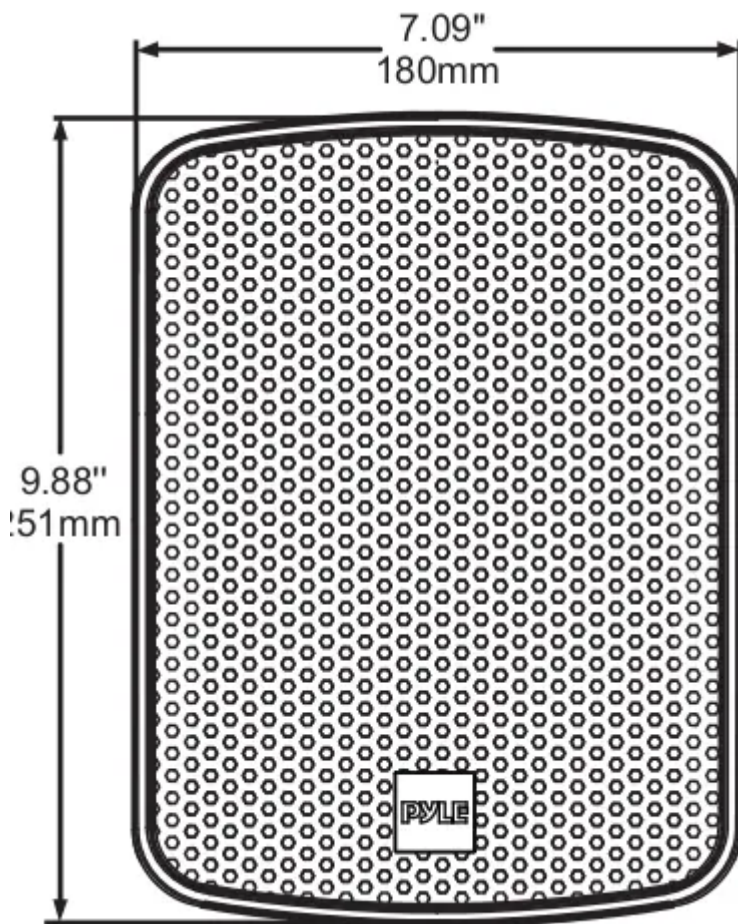

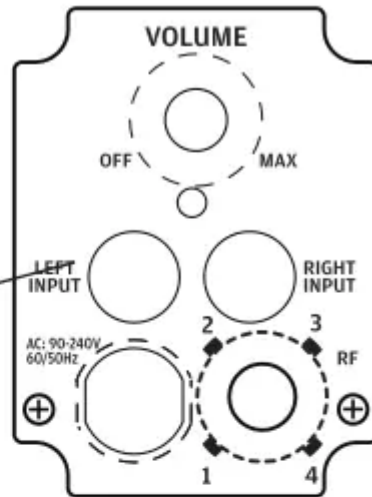
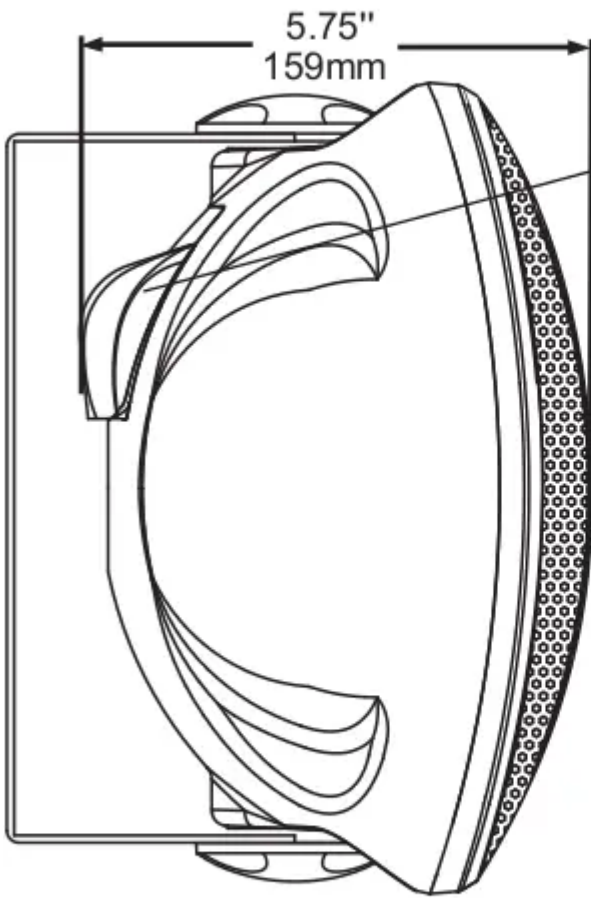

Master Controller Panel

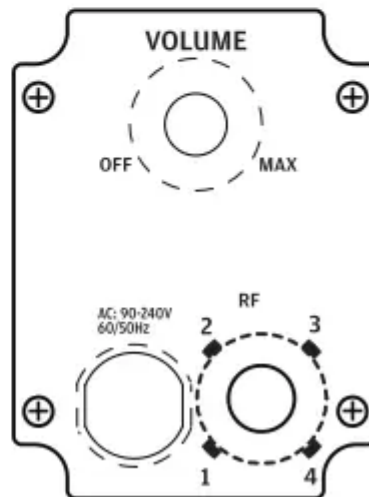

Slave Controller Panel



MODEL	DIMENSIONS (L x W x H)
PDWR55BTRFB	5.75" x 7.09" x 9.88" 159 x 180 x 251mm
PDWR55BTRFW	
PDWR65BTRFB	7.28" x 9.25" x 13.0" 198 x 235 x 330mm
PDWR65BTRFW	

***RF Frequency**

- Rotray to 1 Frequency: 865MHz
- Rotray to 2 Frequency: 865.5MHz
- Rotray to 3 Frequency: 866MHz
- Rotray to 4 Frequency: 866.5MHz

* 4 RF Points Selection to Avoid Interference In Case Nearby it has same System but Different User Installed

* Immediate Connection When RF Point is Selected in Between Master & Slave Speakers

PACKAGING CONTENTS

1. 2 Loudspeakers
2. 2 Brackets
3. 4 Bracket Bolts
4. 4 Screws
- 5.1 RCA Wire



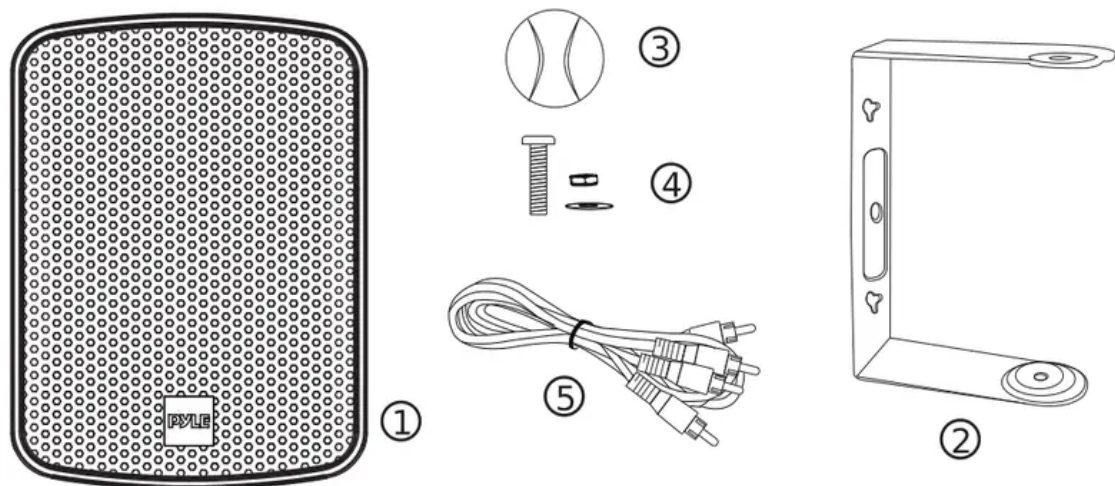

MOUNTING

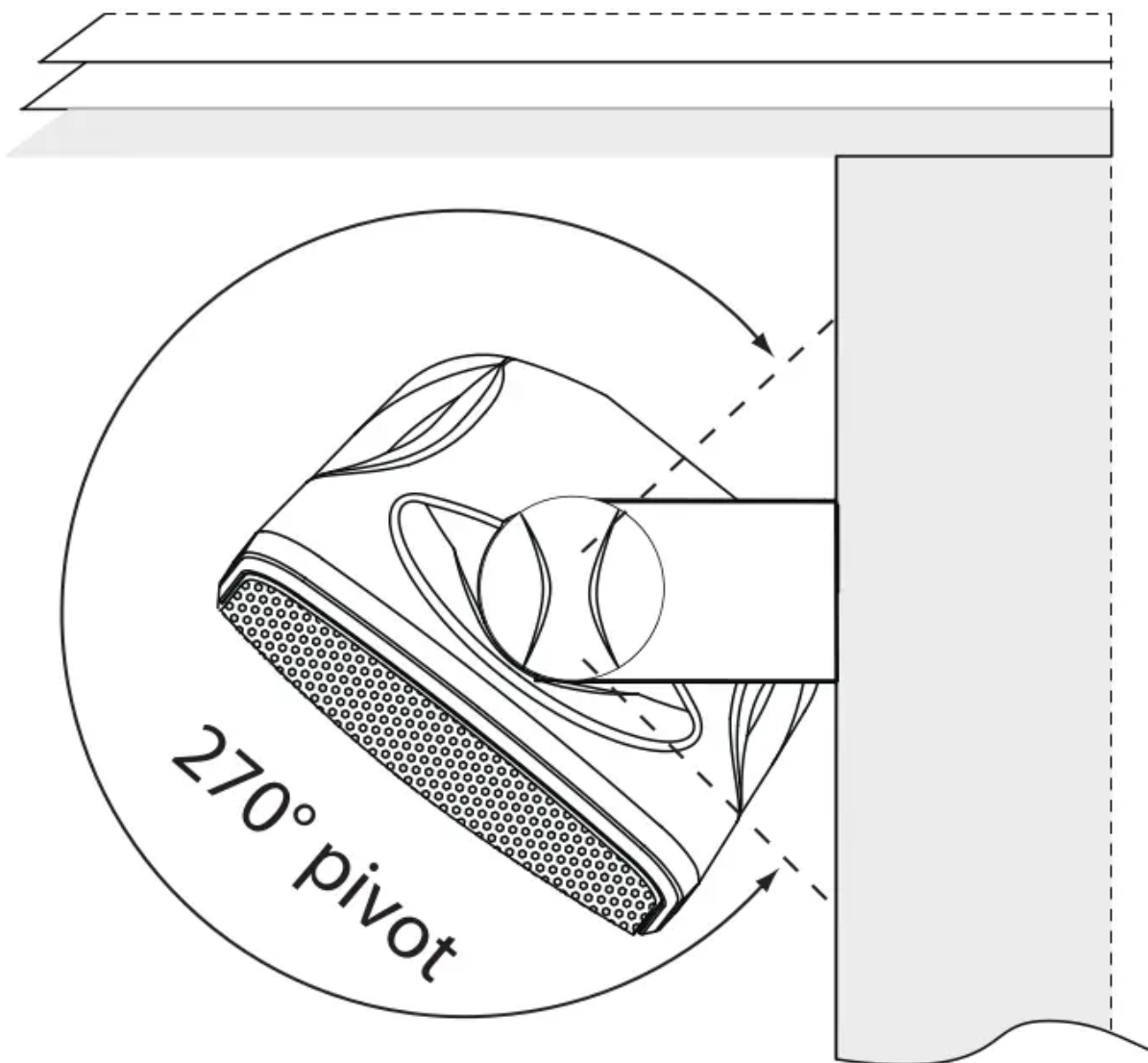

MOUNTING THE BRACKET:

1. Remove the bracket knobs and the bracket from the speaker.

2. Hold the bracket up to the mounting surface. The speaker can be mounted either horizontally or vertically. Hold the bracket so that the speaker wire fits through the large circular wire hole in the bracket. Align the bracket to be square with the surroundings (use a level for accuracy).
3. Mark the locations of the three shaped screw holes. Use all of the holes.
4. Drill pilot holes into the mounting surface.
5. Gently pull the speaker wire through the wire hole in the center of the mounting bracket. Align the bracket so that the holes all line up.
6. Use your hardware to attach the bracket to the mounting surface.

FINAL ADJUSTMENTS:

1. After checking that the speaker is in-phase and works correctly, angle the speaker for the
2. Hand tighten the bracket knobs only. Power tools may over-tighten the knob, and strip the
3. Check that the entire installation is safe and secure.

Contact



- Phone: (1) 718-535-1800
- Email: support@pyleusa.com

Warning

This content is compiled from multiple sources and is provided for reference purposes only. It may not be complete or fully applicable to all situations. If you are unable to resolve your issue, please contact the product manufacturer or an authorized service provider for official support.

