

PRODUCT INFORMATION

Specifications - Direct-Vent Models

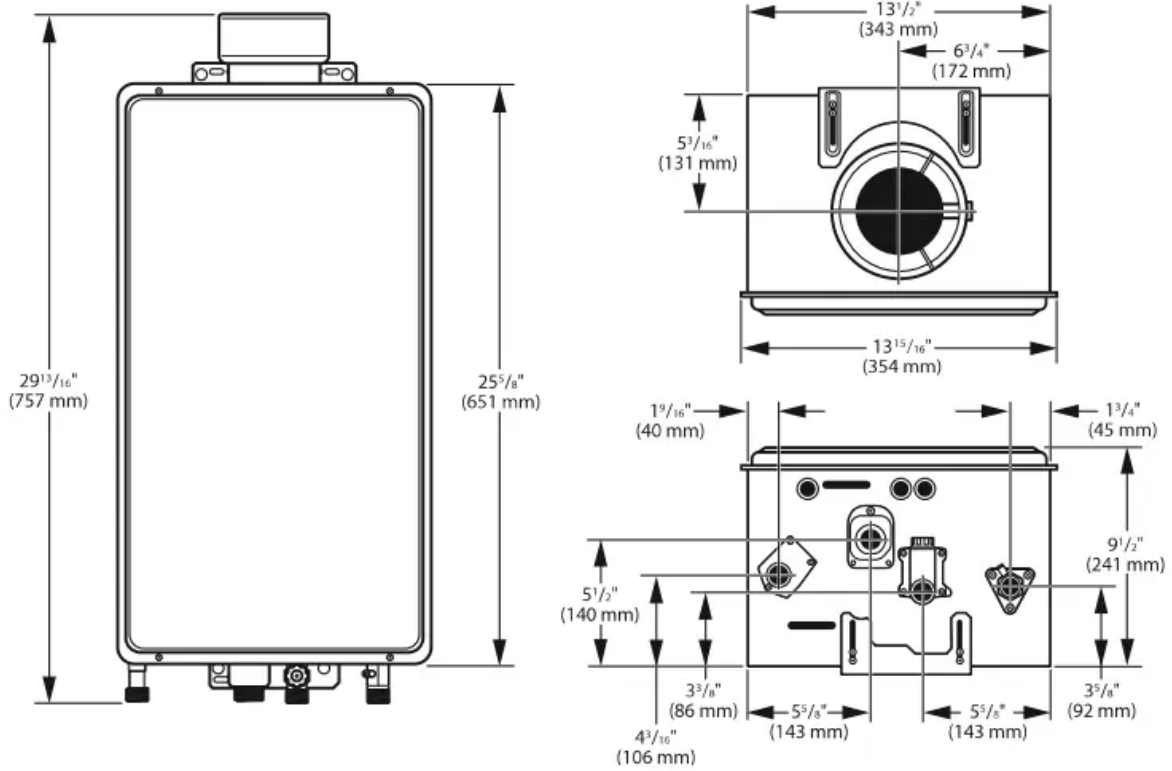

Specifications - Outdoor Models

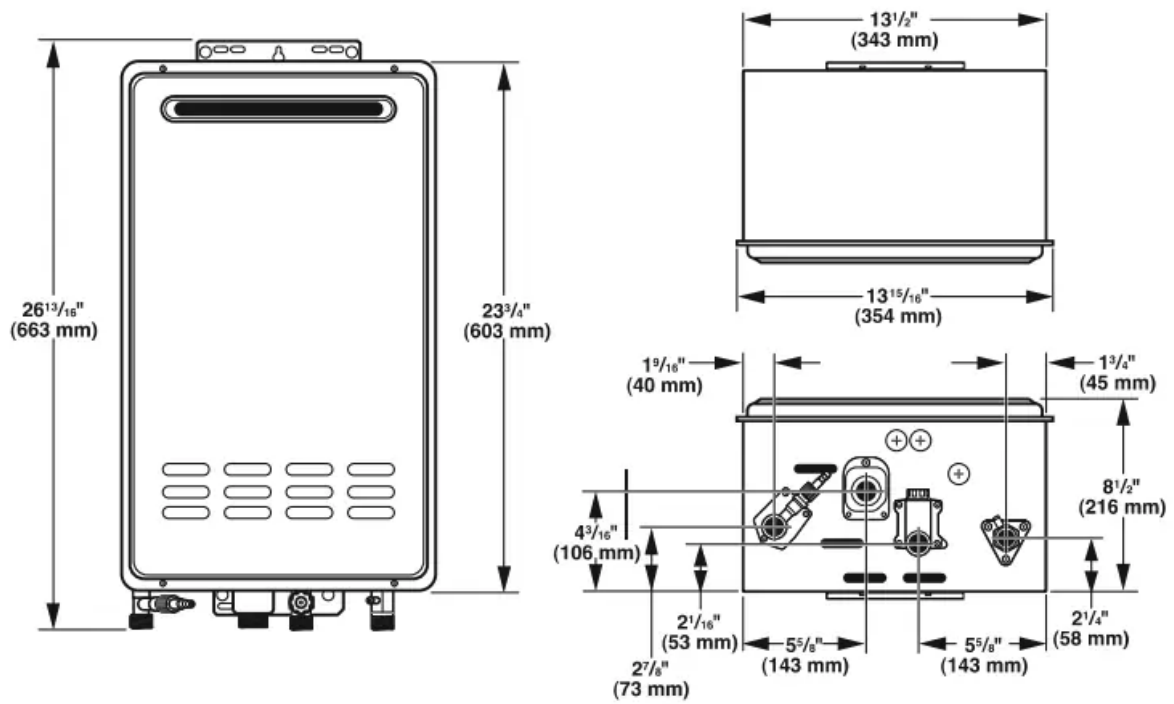

General Descriptions

Typical Direct-Vent Water Heater (Venting Required)



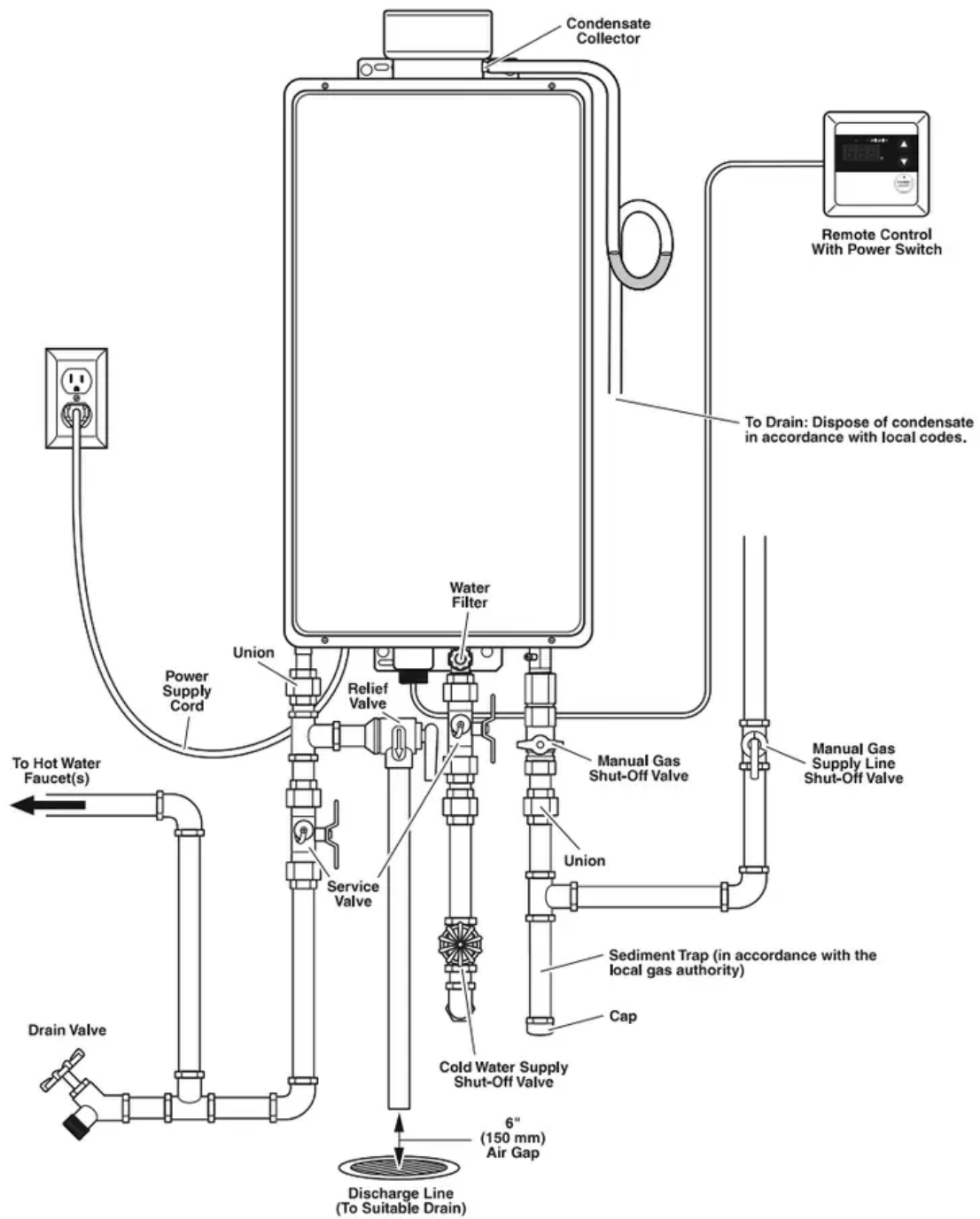

Typical Outdoor Water Heater (No Venting Required)

This water heater is for OUTDOOR installation only.

DANGER:

DO NOT install this water heater indoors or in a confined area. It is designed for outdoor installation only. Any other type of installation will result in death or serious personal injury.



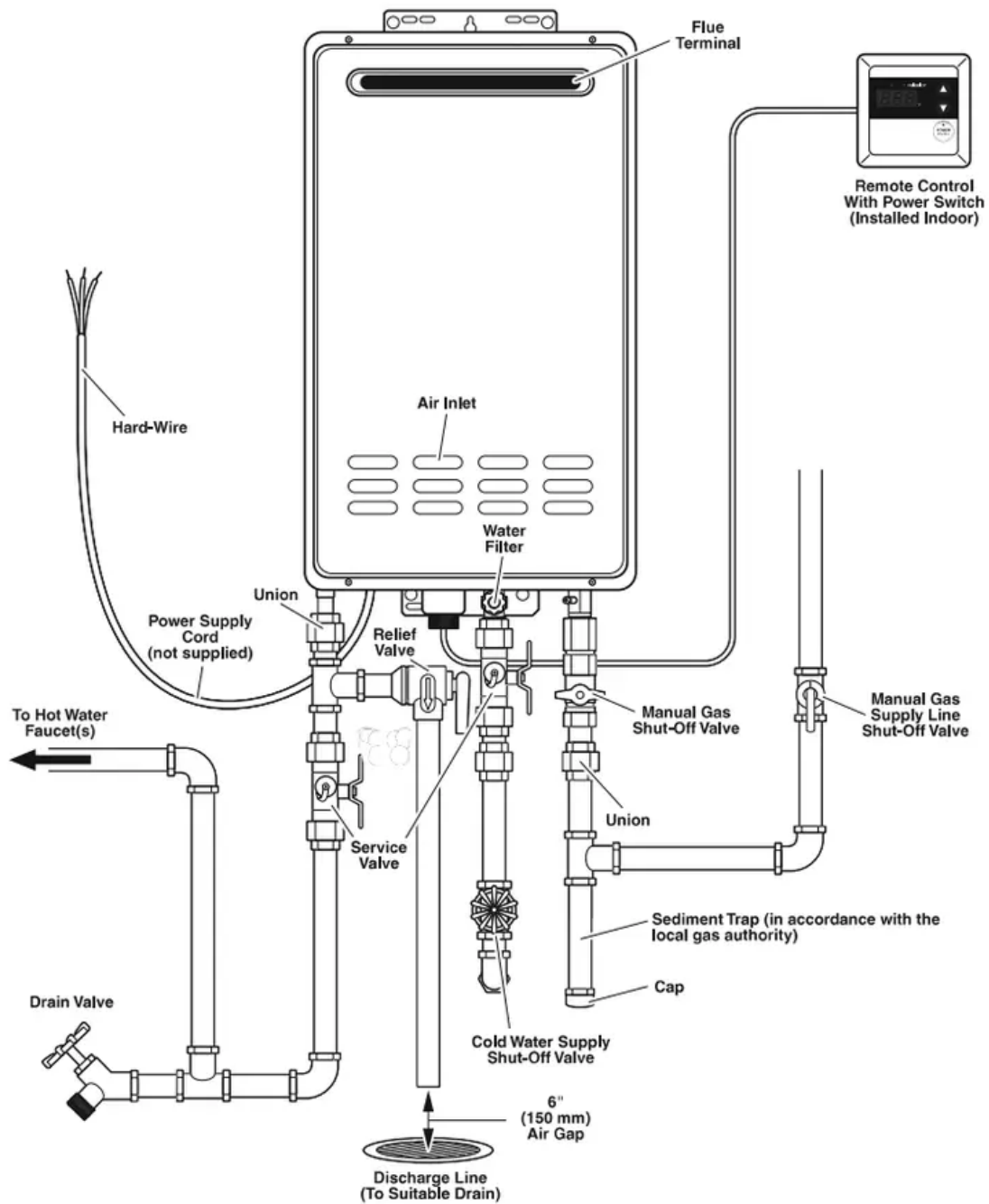

USING YOUR WATER HEATER

Safety Precautions

WARNING:

- Flammable vapors can be drawn by air currents from surrounding areas to the water heater. Vapors can ignite causing death, personal injury, or product damage.
- DO NOT store or use flammable or combustible materials (gasoline, paint thinner, adhesives, newspapers, rags, mops, etc.) in the vicinity of the water heater or any other gas

appliance. If they must be used, open doors and windows for ventilation, and shut off all gas-burning appliances, including their pilot lights.

- DO turn off manual gas shut-off valve if water heater has been subjected to overheating, fire, flood, physical damage, or if the gas supply fails to shut off.
- DO NOT turn on water heater unless water and gas supplies are completely opened.
- If there is any difficulty in understanding or following the operating and care instructions in this manual, it is recommended that you contact a qualified service technician to perform the work.

Setting the Water Temperature

DANGER:

Water temperatures above 125°F (52°C) will result in death and/or severe burns from scalding.

Safety and energy conservation are factors to be considered when selecting the water temperature setting. The temperature of the water in the water heater can be regulated by setting the temperature on the front of the remote control. Be sure to read and follow the warnings outlined on the pictured label.

The remote control has been preset and shipped at the recommended temperature setting.

Safety factors should be considered whenever altering the water temperature setting. The chart below may be used as a guide in determining the proper water temperature for your home.

Time/Temperature Relationship in Scalds

Water Temperature	Time to Produce a Serious Burn
120°F (49°C)	More than 5 minutes
125°F (52°C)	1 1/2 to 2 minutes
130°F (54°C)	About 30 seconds
135°F (57°C)	About 10 seconds
140°F (60°C)	Less than 5 seconds
145°F (63°C)	Less than 3 seconds
150°F (66°C)	About 1 1/2 seconds
155°F (68°C)	About 1 second

Table courtesy of Shriners Burn Institute

DANGER



Water temperature over 125° F can cause severe burns instantly or death from scalds.

Children, disabled and elderly are at highest risk of being scalded.

See instruction manual before setting temperature at water heater.

Feel water before bathing or showering.

Temperature limiting valves are available, see manual.

Maximum water temperature occurs while the water heater burner is on. To determine the water temperature:

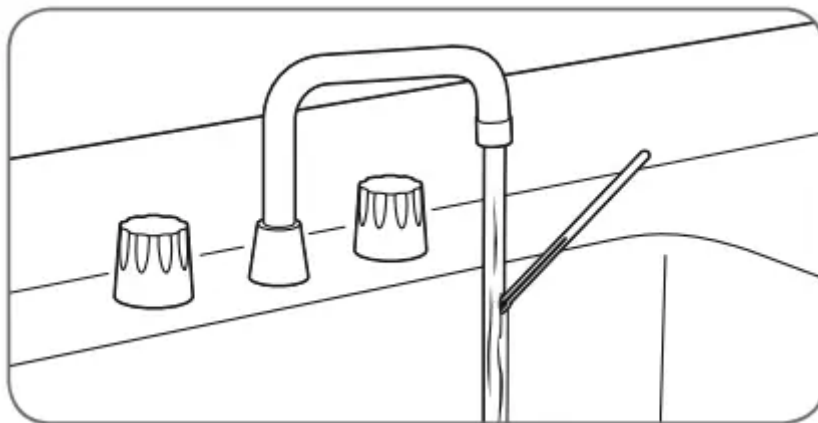

Turn on the hot water faucet and place a thermometer in the water stream.

NOTICE:

Water temperature at the faucet may vary depending on the season and the length of pipe from the water heater.

The remote control temperature range is between 100°F (38°C) and 120°F (49°C). To adjust the temperature to a desired setting, press the UP or DOWN adjustment button on the face of the remote control. The new temperature set point will show on the LED display.

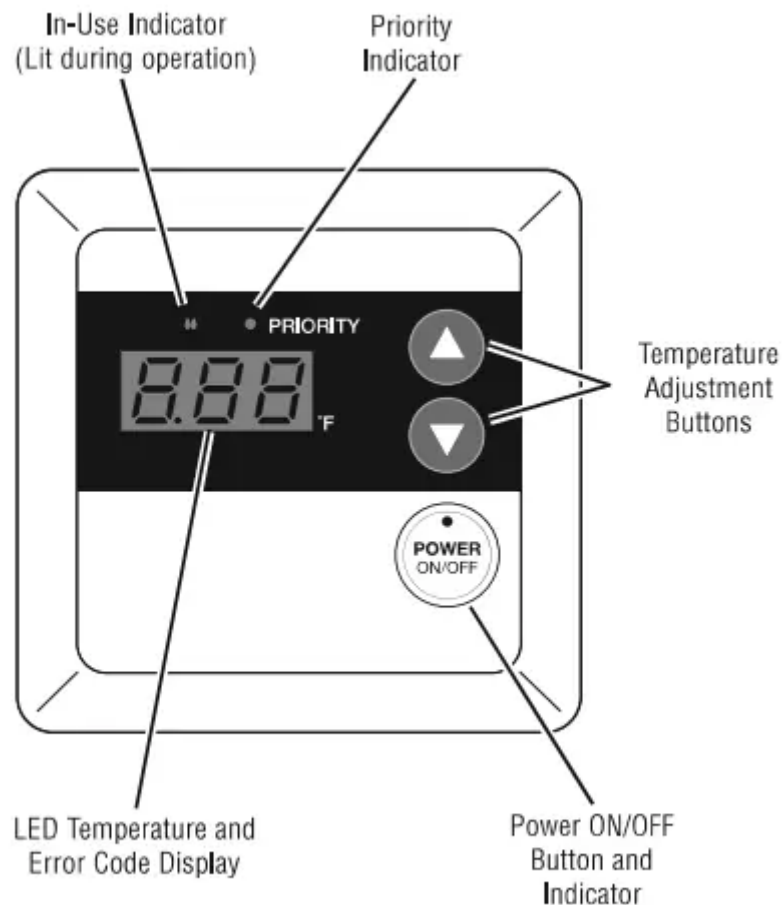

NOTICE:

The temperature set point on the standard remote control cannot be increased above 112°F (44°C) when a hot water faucet is in the open position. To achieve temperatures above 120°F (49°C) or below 85°F (29°C), contact a qualified service technician. Only factory-authorized remote control(s) should be used. The water heater may not operate with a small water flow. Increase the water flow and recheck. If it still does not operate with the hot water faucet completely open, increase the temperature setting on the remote control.

Water Heater Facts

DANGER:

Water temperatures above 125°F (52°C) will result in death and/or severe burns from scalding.

- The hottest-temperature water will be at the faucet closest to the water heater.
- Always remember to test the water temperature with your hand before use.
- Always supervise young children or others who are incapacitated.
- The water heater is equipped with a device that will shut off the gas supply to the burner if the water heater exceeds normal operating temperatures.

- Any water heater that has been subjected to fire, flood, physical damage, or been under water should be turned off at the manual gas shut-off valve and not used until it has been checked by qualified service personnel.

CARING FOR YOUR WATER HEATER

Water Heater Inspections

Venting System (Direct Vent Only)

The venting system should be inspected annually by a qualified service technician to ensure all of the vent sections are secure and airtight.

WARNING:

DO NOT operate the water heater if the vent system shows signs of leaking exhaust. Leaking exhaust could lead to death, personal injury, and/or product failure.

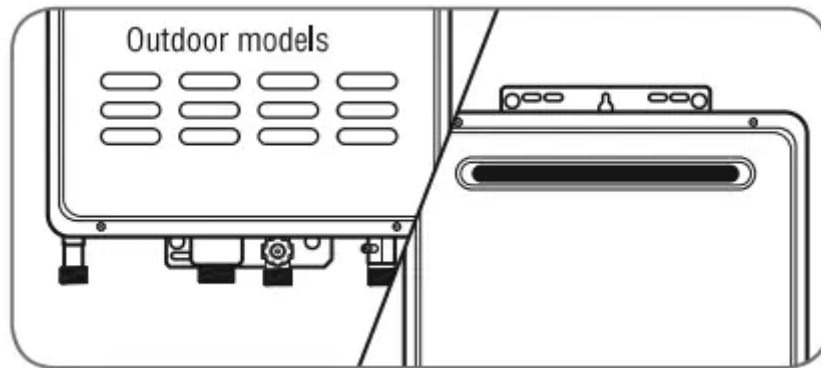

Check the air intake and vent outlet for blockage and/or debris.

Condensate Trap (Direct Vent Only)

CAUTION:

DO NOT operate without the condensate trap connected to the vent and routed to the proper drain. It could cause the system to malfunction or fail.

On a regular basis, inspect the condensate trap to ensure there is enough water in the trap and the condensate is draining properly.

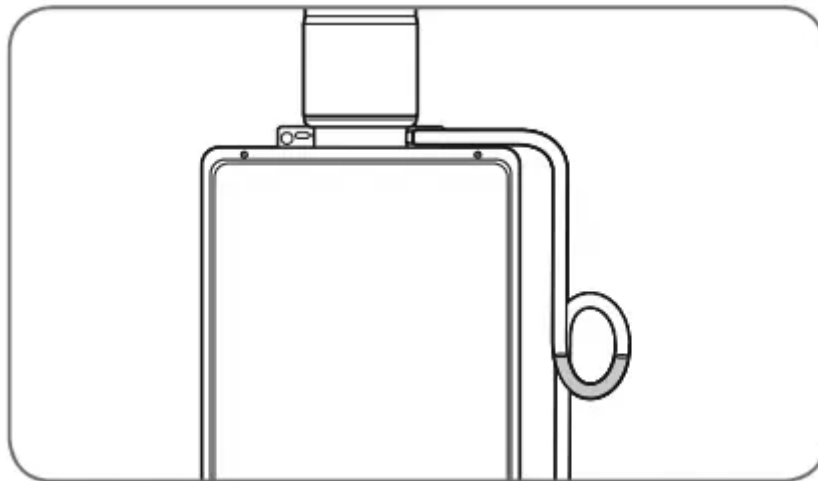

Ensure that condensate is disposed of per local codes and regulations.

Burner

It is recommended that the burner be inspected annually by a qualified service technician.

DANGER: Shock Hazard - Removing the front cover panel exposes you to live electricity. Electric shock will cause death or serious personal injury.

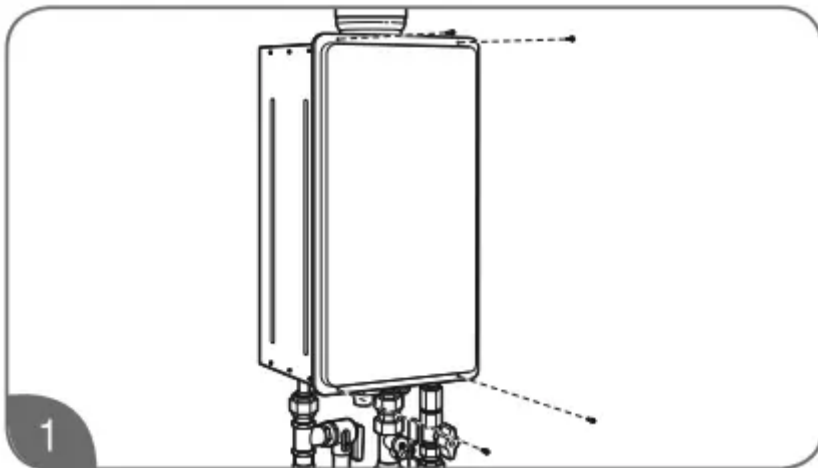

Remove 4 screws and the unit cover panel.

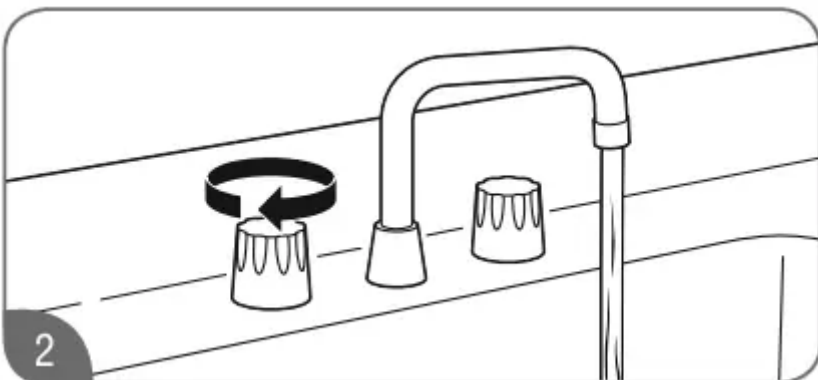

Turn on a hot water faucet.

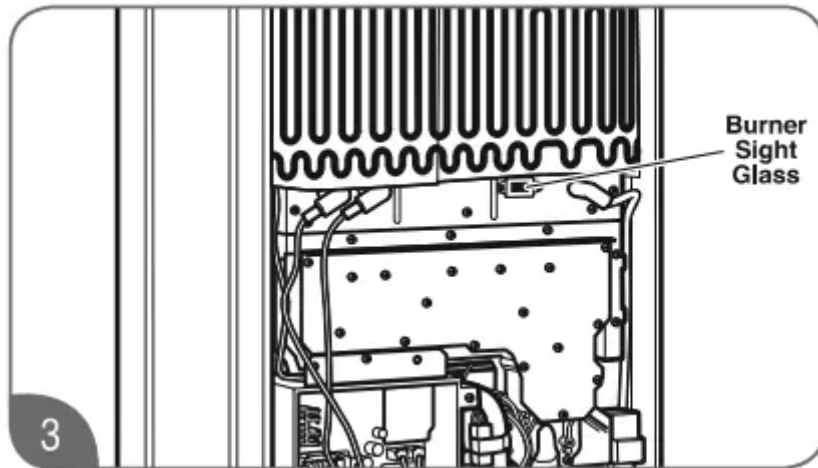

While the water heater is operating, inspect the main burner flames through the burner sight glass. The flames should be blue when the main burner is firing.

NOTICE: If the flames are not blue or you observe unusual burner operation, shut off the water heater and contact a qualified service technician.

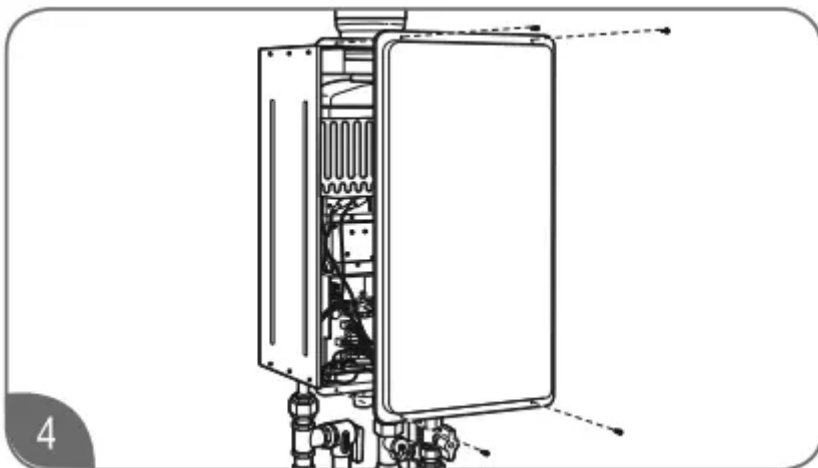

Turn off the hot water faucet and reinstall the unit cover panel.

Care and Cleaning

DANGER: Shock Hazard - Make certain power to the water heater is OFF before removing protective cover for any reason. Electric shock will cause death or serious personal injury.

WARNING: Combustible materials, such as clothing, cleaning materials, or flammable liquids, must not be placed against or next to the water heater. Fire or explosion can occur causing death, personal injury, and/or product damage.

All care and cleaning to and around the water heater should only be performed with the water heater turned off and the electrical power supply disconnected.

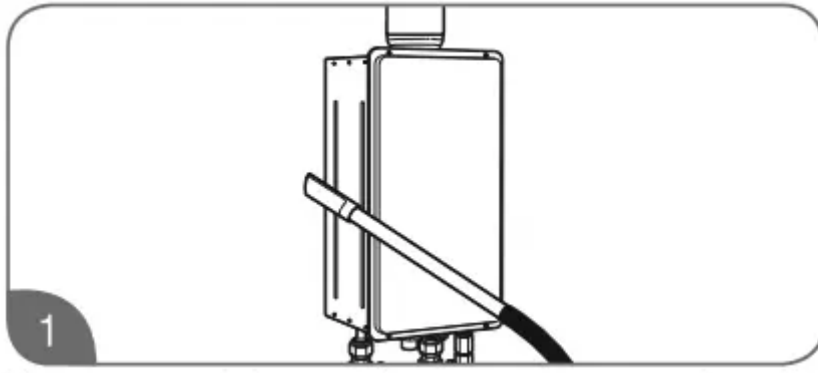

Vacuum around the water heater to remove any dust, dirt, and/or lint buildup.

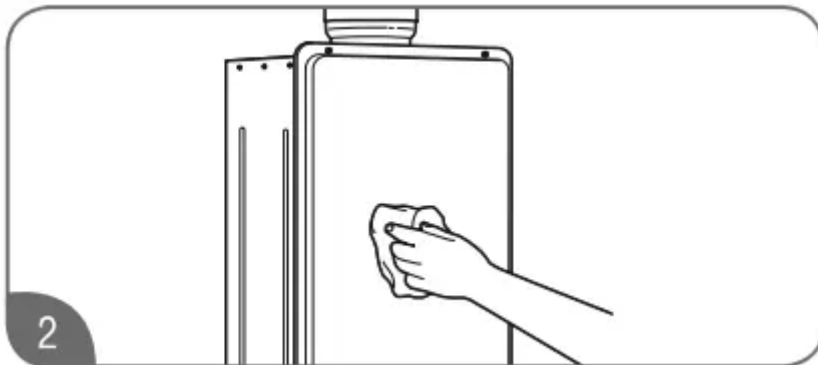

Clean the water heater and the remote control with a damp soft cloth and mild detergent. Gently wipe and completely dry all surfaces.

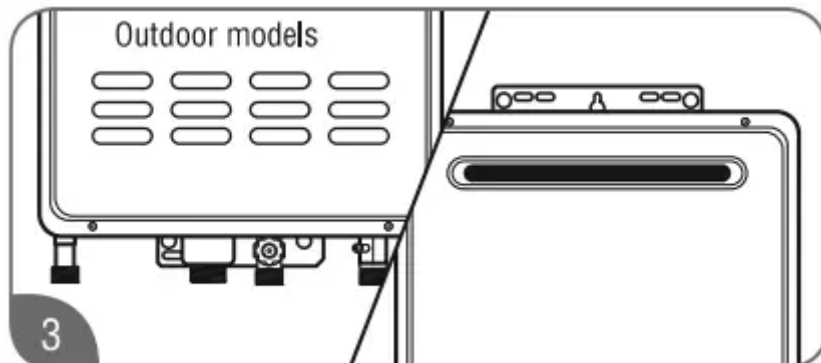

Check the air intake and vent outlet for blockage and/or debris.

NOTICE: The air intake requires a minimum of 12 in. (30 cm) of clearance between the air intake opening and any obstruction.

Clean the water filter monthly, as described below and on page 18.

Water Filter Cleaning

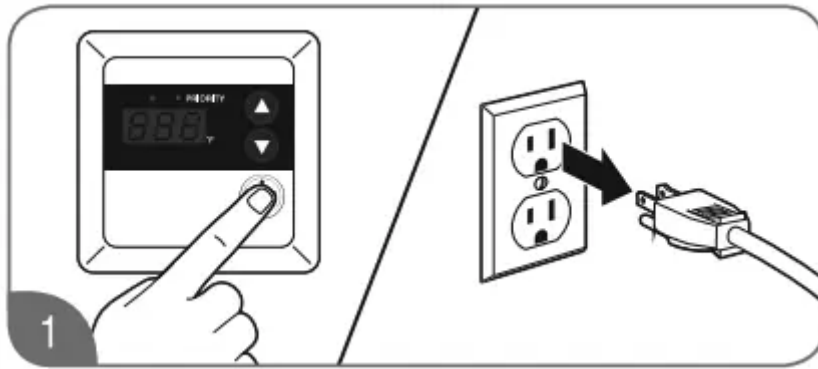

Turn off the water heater and disconnect the electrical power supply.

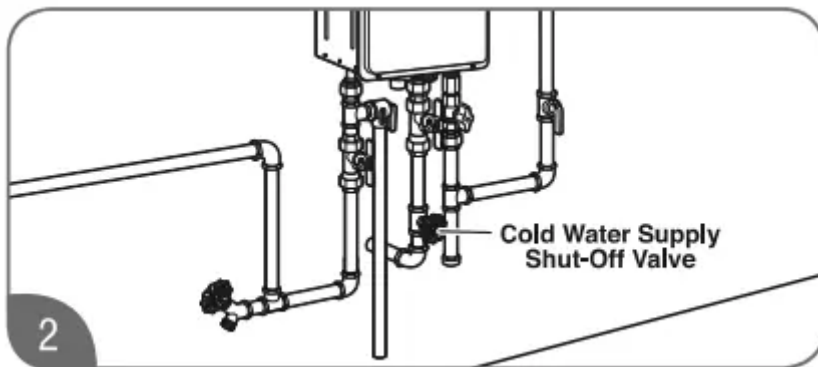

Turn off the water supply to the water heater.

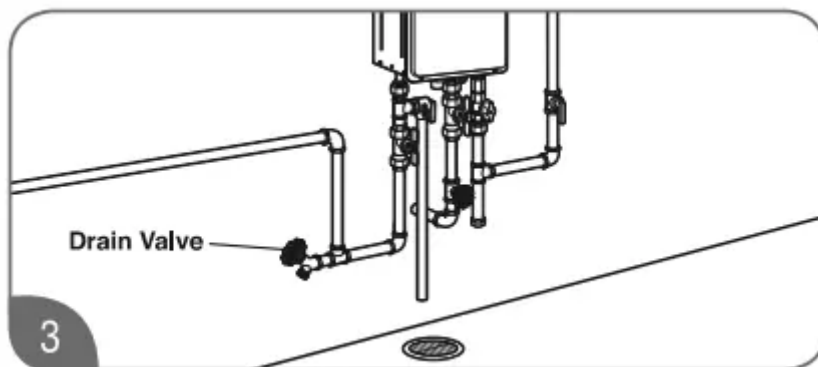

Drain the water heater. See page 20.

CAUTION: DO NOT tap or force the filter during removal. This can deform and/or damage the filter.

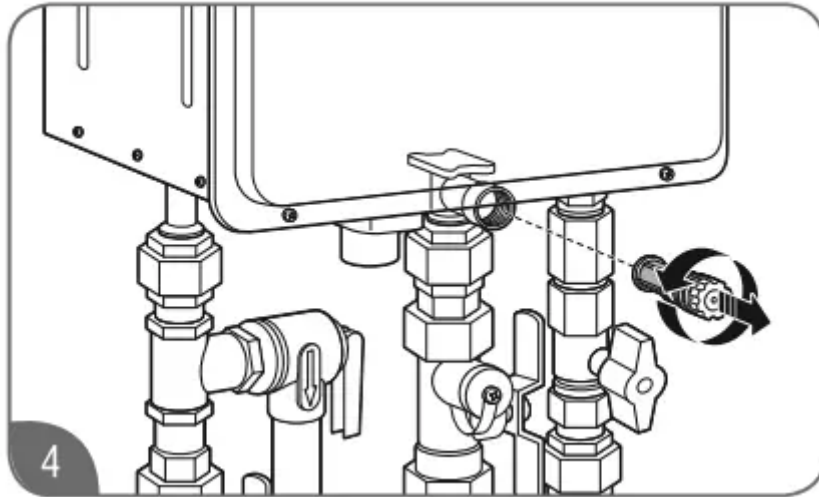

Unscrew the water filter from the base of the cold water inlet line and carefully slide it out of the line.

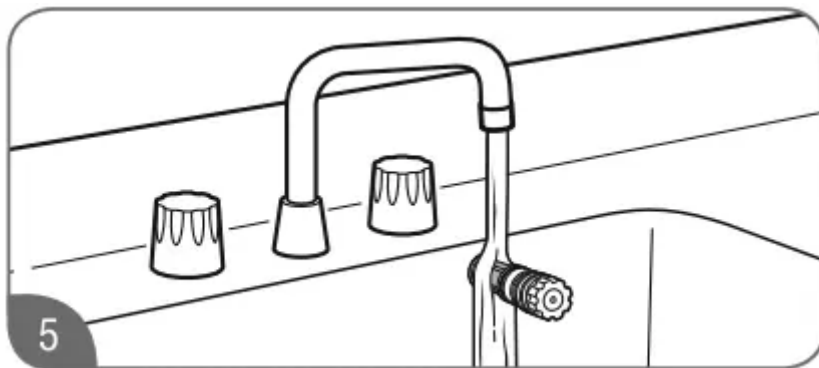

Clean the water filter under running water. To remove severe sediment and dirt, use a soft brush.

CAUTION: DO NOT overtighten the water filter. Overtightening can deform and/or damage the filter.

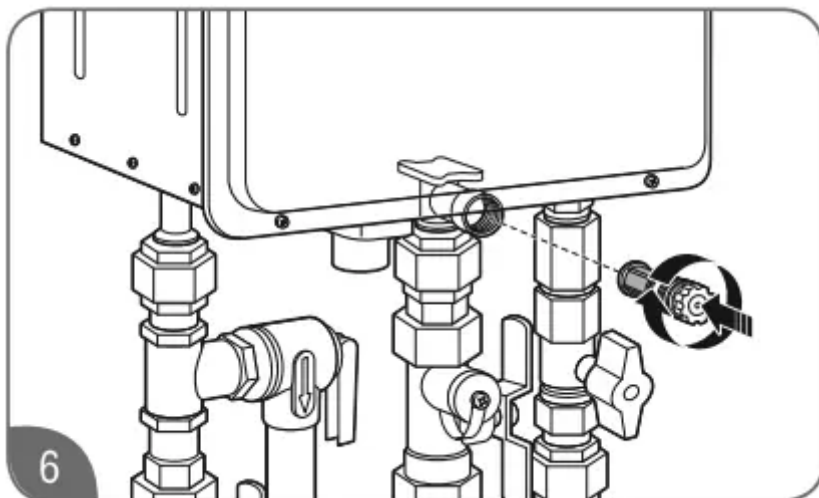

Replace the filter in the cold water inlet line and tighten until it is snug.

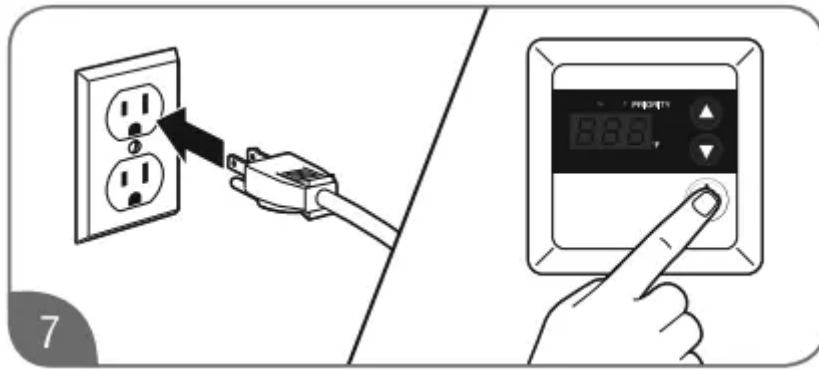

Turn on the water supply, reconnect the electrical supply, and turn on the water heater.

Preventive Maintenance

WARNING:

Failure to perform routine preventive maintenance can prevent the water heater from operating properly. Improper operation can cause carbon monoxide dangers, excessive water temperatures, and other potentially hazardous conditions resulting in death, personal injury, and/or product damage. Properly maintaining your water heater will ensure dependable, trouble-free service.

User Preventive Maintenance

Establish and follow a routine preventive maintenance program. The following suggested items should be included in your program.



Monthly check and clean the water filter. See “Water Filter Cleaning” on page 17.

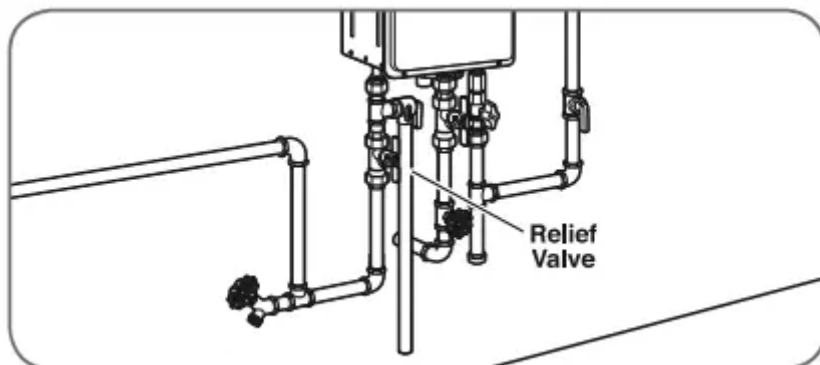

Annually check the operation of the pressure-relief valve. Lifting the lever handle on the pressure-relief valve opens the valve to flush hot water through the discharge line to the drain. After several gallons have drained, release the lever handle to close the valve and stop draining.

NOTICE:

If the pressure relief valve on the hot water heater discharges periodically, this may indicate a problem in the water system. Contact the water supplier or a plumbing contractor to correct the problem. **DO NOT** plug the relief valve outlet.

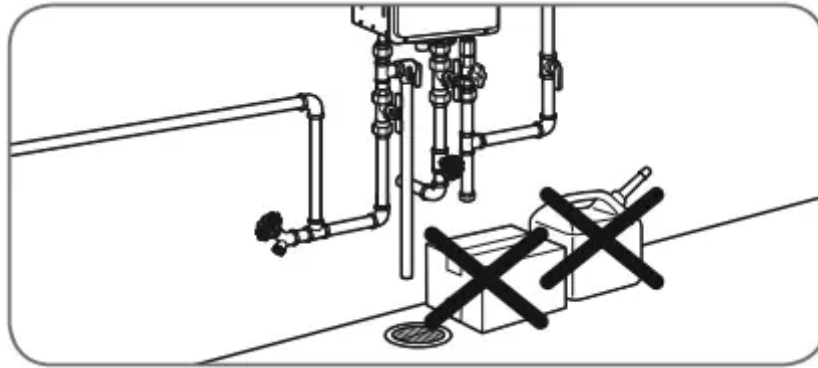

- Inspect and keep the area around the water heater clear and free of flammable materials, such as gasoline and other flammable vapors and liquids.
- Visually inspect the water heater for damage and/ or denting. If present, contact a service personnel to verify proper operation.
- Check for abnormal sound during normal operation (e.g., hissing or banging noises). Contact a qualified service technician or plumbing contractor.
- Check all gas and water pipes for leaks. See page 54.

NOTICE:

- DO NOT operate the water heater if you feel something is wrong with the unit.
- DO NOT allow children to operate or handle the unit.
- After inspections, maintenance, and/or cleaning, ensure proper operation by turning on a hot water faucet.

Professional Preventive Maintenance

It is recommended that a periodic inspection of the water heater burner, relief valve, air intake filter, water filter, and venting system be made by a qualified service technician.

WARNING:

Certain water conditions can damage the water heater and may cause defects, malfunctions or failures of the water heater that are not covered by the limited warranty. See page 46 for more detail.

Draining the Water Heater

WARNING:

Failure to follow these draining instructions can cause serious personal injury from scalding and/or product damage.

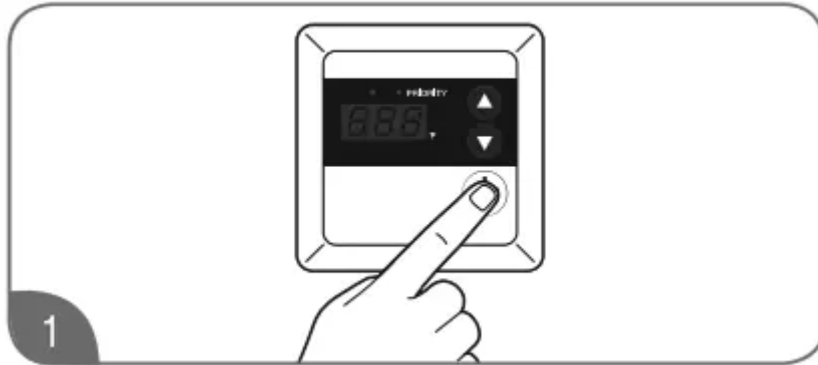

Turn off the water heater by pressing the POWER ON/OFF button on the control panel.

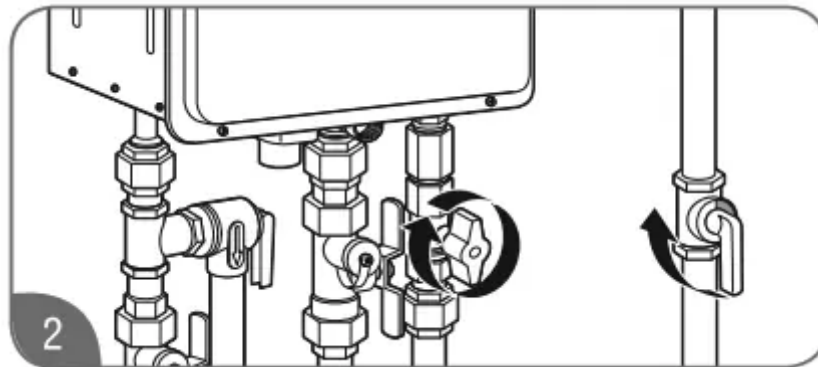

Close the gas shut-off valve(s).

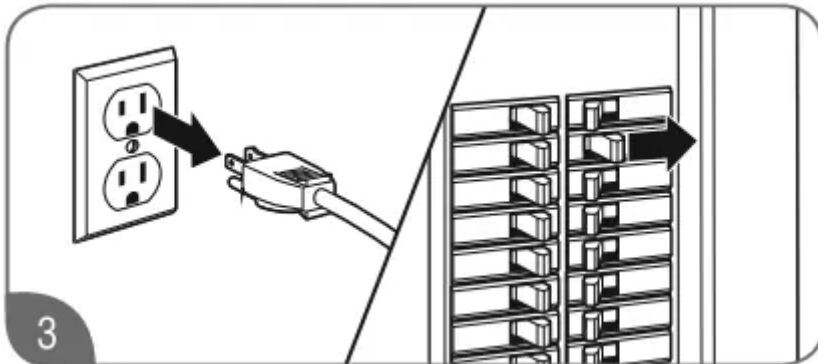

At least 10 seconds after Step 1, unplug the water heater or disconnect the power supply at the circuit breaker box.

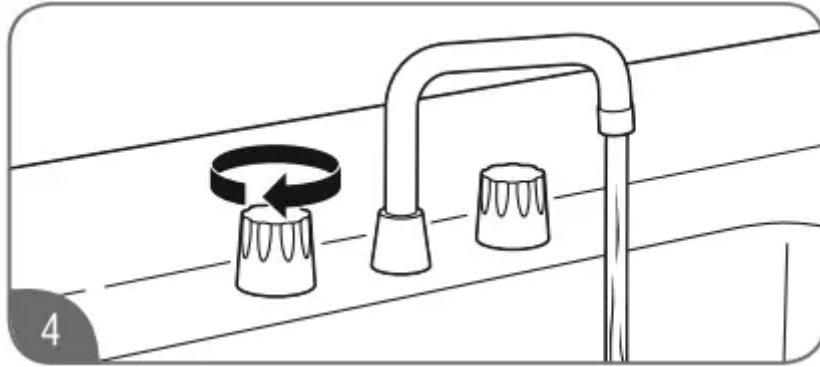

Open all hot water faucets. Run the water until it is COLD; then shut off the faucet.

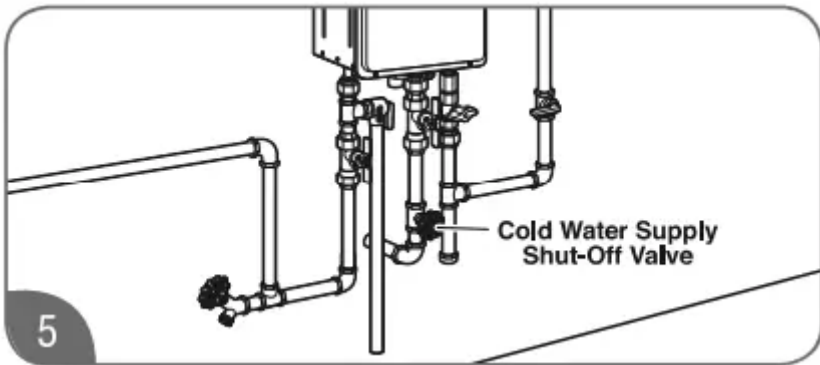

Close the water shut-off valve.

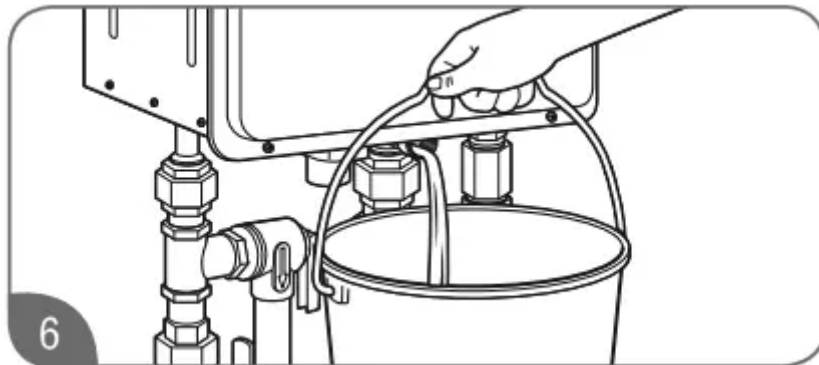

Using a suitable container to catch the water, remove the water filter from the base of the cold water inlet line.

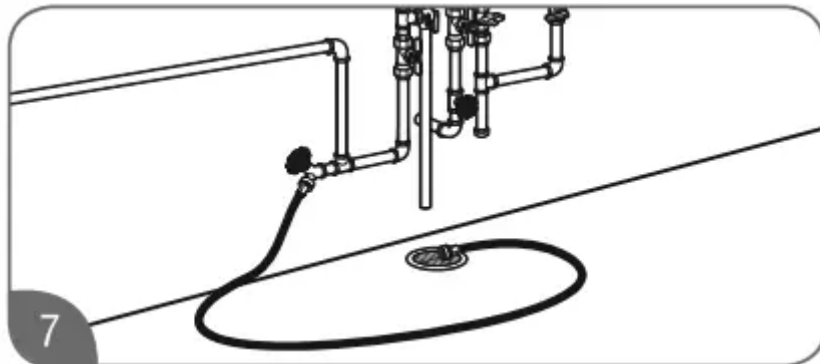

Connect a garden hose to the drain valve in the hot water outlet line and place the other end in a suitable drain. Open the drain valve until all the water has drained from the water heater. Leave water heater as is until placed back in service.

CAUTION:

Even when drained properly, a small amount of water will remain in the water heater. In cold weather conditions, this water can freeze. If this happens, allow the defrost protection on the water heater at least 30 minutes to melt the frozen water. The water heater will not work properly until this water is thawed.

To put the water heater back in service:

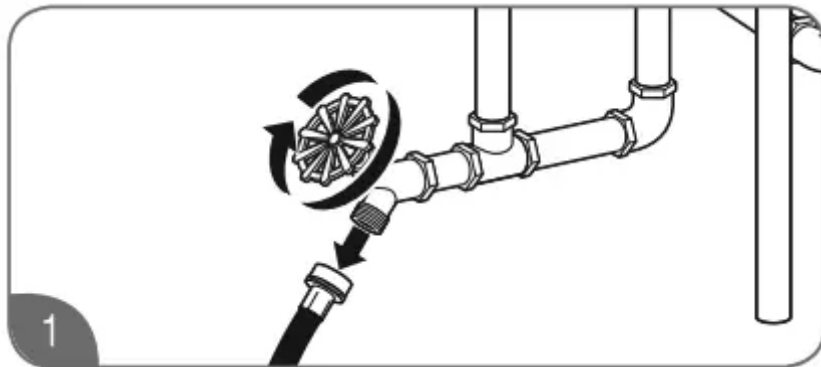

Disconnect drain hose. Make sure the drain valve is closed.

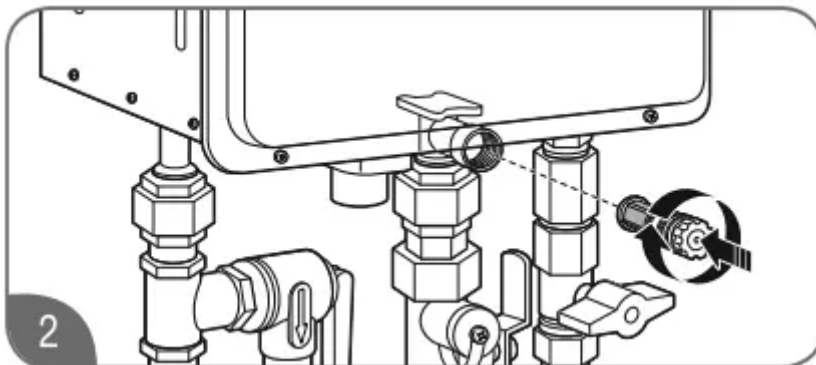

Reinstall the water filter in the base of the cold water inlet line.

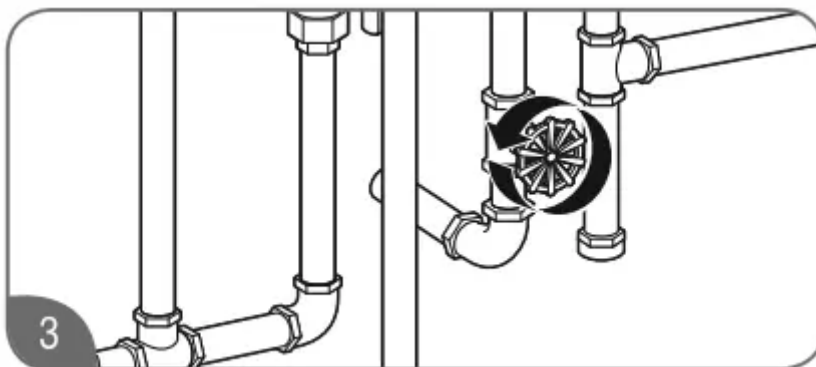

Open the water shut-off valve

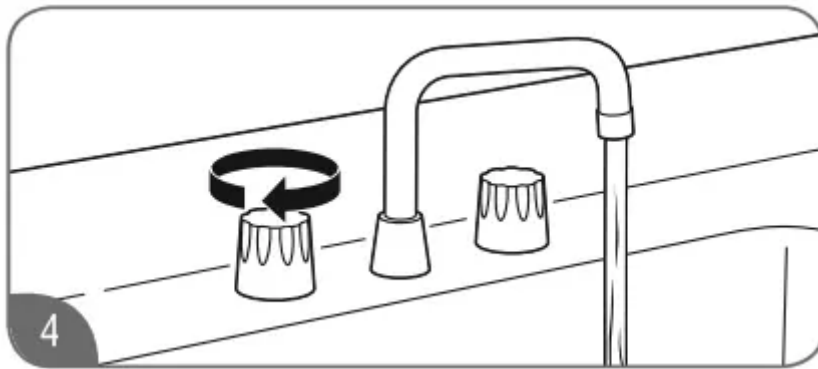

Open all hot water faucets and let run until all air has been purged from the lines.

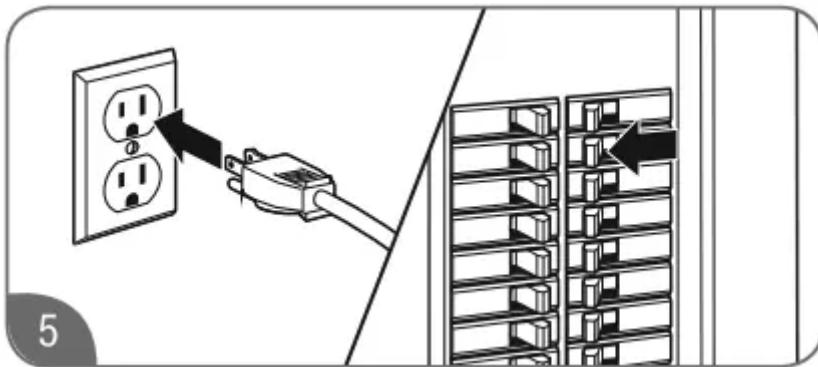

Plug in the power cord or reconnect the power supply at the circuit breaker box.

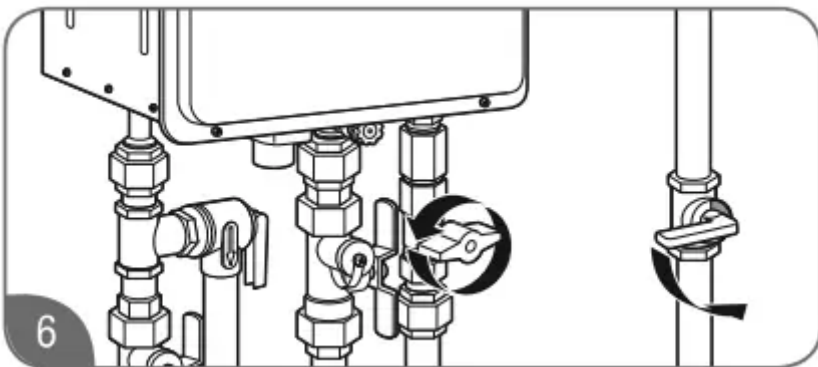

Open the gas shut off valve(s)

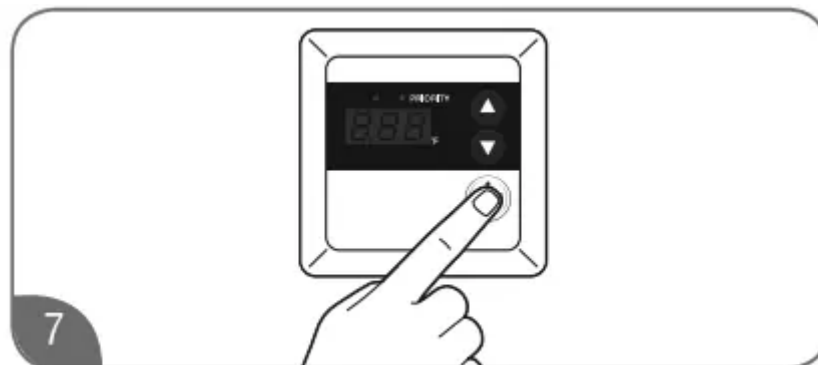

Press the POWER ON/OFF button on the control panel to restart the unit.



Preferred Drain Method

Isolator valve kits may be purchased from the manufacturer, distributor, or place of purchase. The kits include two full port isolation valves to be used in the inlet and outlet water lines. It is highly recommended to install isolator valve kits because these kits provide a means for full diagnostic testing and ease of system flushing.

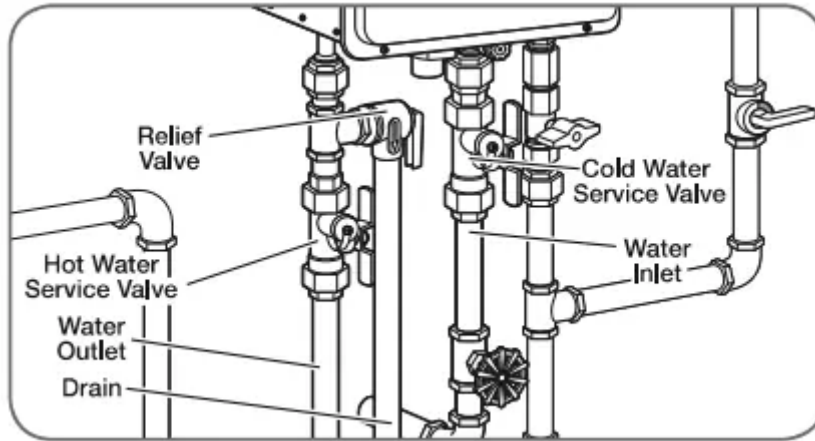

Freeze Protection

WARNING:

Failure to drain the water heater can cause serious personal injury from scalding and/or product damage.

Whenever the water heater may be exposed to freezing conditions, make sure to completely drain the water from the unit. See page 20.

Freezing conditions come from the ventilation system on direct-vent models and from exposure to cold air on outdoor models.

All of these water heaters are equipped with a freeze protection electric heater. This heater prevents freezing inside the water heater down to an ambient temperature of approximately -30°F (-34°C). These temperatures are all based on temperatures without wind.

The heater only protects the internal components of the water heater.

NOTICE:

Unplugging or disconnecting the power supply to the water heater will also disconnect the power to the heater.

External piping and valves require additional freeze protection. One method is to wrap insulation around the piping and valves.

Another method is to turn on a hot water faucet and leave a small amount of water running at a faucet. This will protect the water heater, piping, and valves from freezing.

Running Water Freeze Protection

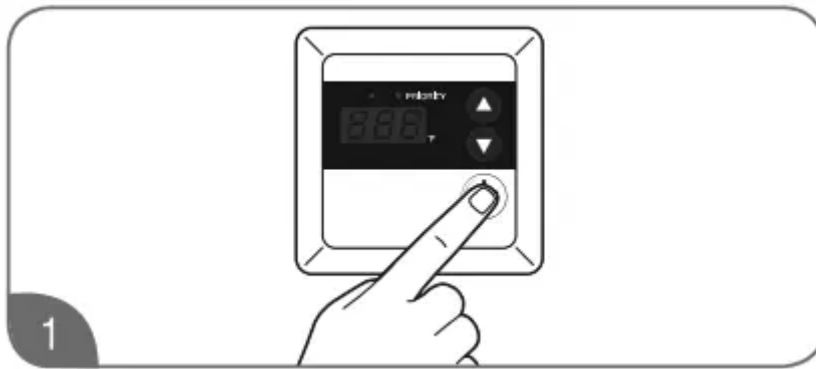

Turn off the water heater by pressing the POWER ON/OFF button on the control panel.

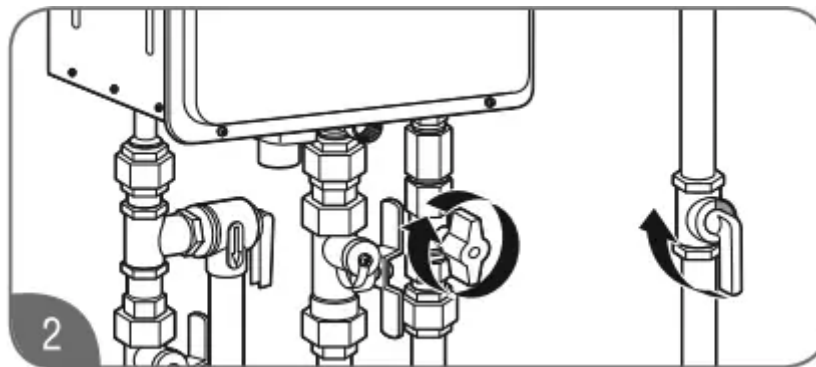

Close the gas shut off valve(s)

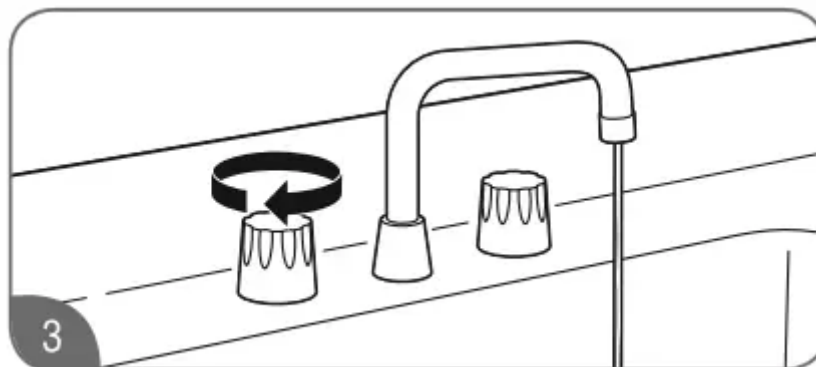

Open a hot water faucet slightly until the water stream is approximately 1/8 in. (0.3 cm). Be sure to check the flow periodically.

Vacation and Extended Shutdown

WARNING:

Failure to drain the water heater can cause serious personal injury from scalding and/or product damage.

If the water heater is to remain idle for an extended period of time, the power and water to the heater should be turned off.

The water heater and piping should be drained if they might be subjected to freezing temperatures. See “Freeze Protection” section on page 22. After an extended shutdown, the water heater’s operation and controls should be checked by a qualified service technician.

Troubleshooting Chart

The information in the following troubleshooting chart may help you diagnose and/or fix a problem you may be experiencing. Please review this chart before calling for service assistance.

DANGER: Shock Hazard - Make certain power to the water heater is OFF before removing protective cover for any reason. Electric shock will cause death or serious personal injury.

WARNING:

For Your Safety, DO NOT attempt repair of electrical wiring, gas piping remote control, burners, vent connectors, or other safety devices. Refer repairs to a qualified service technician.

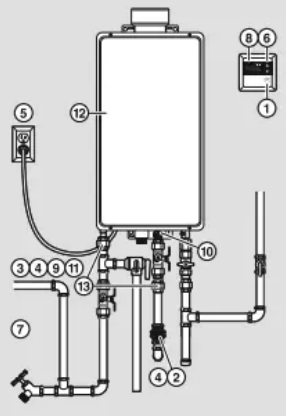

Problem	Possible Cause	Solution
<p data-bbox="172 302 464 376">Not enough or no hot water.</p> 	1. Unit is not ON.	1. Turn on the unit by pressing the POWER ON/OFF button.
	2. Water shut-off valve is not completely opened.	2. Check shut-off valve and open completely.
	3. Hot water faucet is not completely opened.	3. Open hot water faucet completely. (The main burner goes off when incoming water volume is inadequate.)
	4. Water piping is frozen.	4. Allow piping to thaw.
	5. Electrical power is disconnected or water supply is shut off.	<p data-bbox="949 925 1377 1048">5a. Plug in the power cord or reconnect the power supply at the circuit breaker box.</p> <p data-bbox="949 1077 1412 1238">5b. Completely open the water supply valve. (Inadequate water volume will cause the main burner to turn off.)</p>
	6. The temperature may be set too low.	6. Increase the temperature setting.
	7. Mixing valve malfunctions (if applicable).	7. Check and replace the mixing valve.
	8. Error code displayed on the remote control.	8. See “Service Error Code Chart” on page 25. If required, contact a qualified service technician.
	9. Not enough water demand.	9. Increase the hot water flow at the faucet.

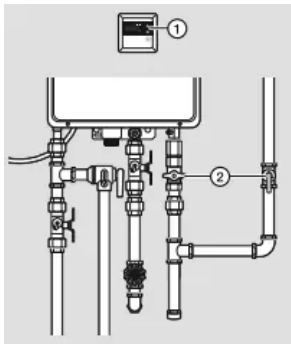
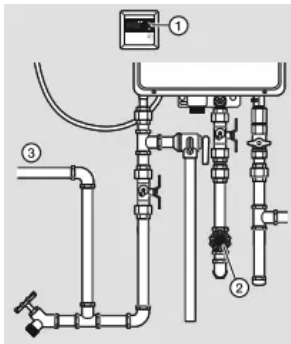

	10. Water filter is clogged or dirty.	10. Clean the water filter. (See page 17.)
	11. Fixture aerator is clogged or dirty.	11. Clean the aerator.
	12. Scale buildup in the heat exchanger.	12. Check for error code. If required, contact a qualified service technician.
	13. Hot and cold water lines reversed.	13. Reverse the water lines.
<p>Water not hot enough</p> 	1. The temperature may be set too low.	1. Increase the temperature setting at the remote control.
	2. The gas valve is not completely opened.	2. Check and completely open the gas valve.
	3. Gas supply pressure is low.	3. Contact your gas utility company or gas Contractor to verify the gas meter and gas Piping size.
	4. Bleed-over in one of the hot water fixtures.	4. Contact a dealer or a qualified service technician.
<p>Water too hot</p> 	1. Temperature is set too high.	1. Decrease the temperature setting at the remote control.
	2. Water shut-off valve is not completely	2. Check and completely open the water shut off valve.
	3. Small amount of water has been heated.	3. Increase the hot water flow at the faucet to allow more water to flow through the water heater.
	The post-purge cycle clears flue gases.	Normal operation.

Fan continues to rotate after the hot water faucet is closed.

Service Error Code Chart

Your water heater has an electronic diagnostic system built into it. When the water heater finds a problem, it displays an error code in the LED display on the remote control. The following chart lists the error codes along with their possible problem and solution. Using this chart may help you diagnose and/or fix a problem you may be experiencing. Please refer to this chart before calling for service assistance.

DANGER: Shock Hazard - Make certain power to the water heater is OFF before removing protective cover for any reason. Electric shock will cause death or serious personal injury.

WARNING:

For Your Safety, DO NOT attempt repair of electrical wiring, gas piping, remote control, burners, vent connectors, or other safety devices. Refer repairs to a qualified service technician.

When an error code is displayed:

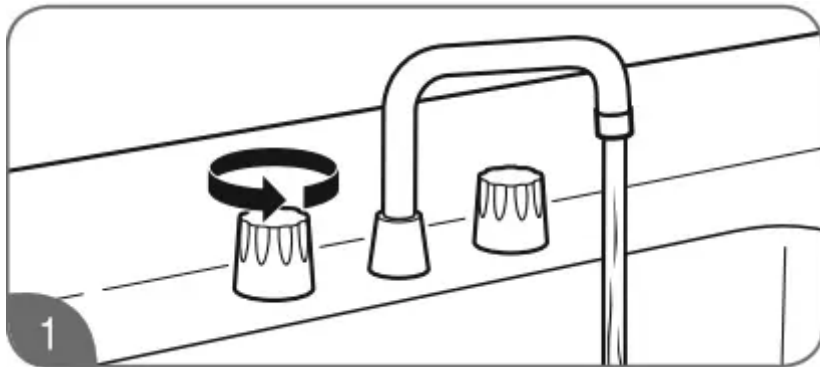

Turn off all the hot water faucets



Turn off the water heater by pressing the POWER ON/OFF button on the remote control.

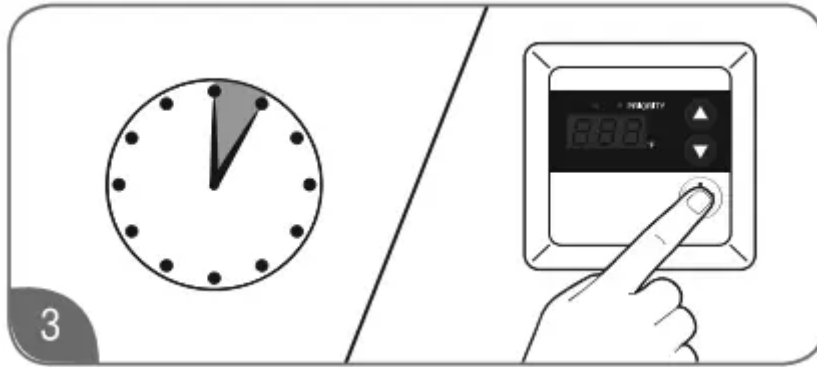

Wait about 5 minutes; then restart the water heater by pressing the POWER ON/OFF button.

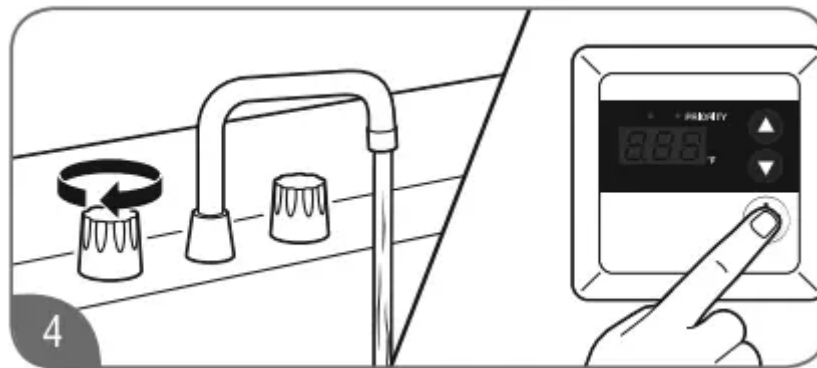

Turn on a hot water faucet and recheck the remote control display.

If the error code remains in the display:

1. Turn off the hot water faucet.
2. Turn off the water heater.
3. Unplug the water heater from power, wait about 30 seconds and plug back in.
4. Follow the error code chart information.
5. Restart the water heater, turn on a hot water faucet, and recheck the remote control display.

If the error code is still shown:

1. Turn off the hot water faucet.
2. Turn off the water heater.
3. Make note of the displayed error code and call for service assistance. See “Call for Assistance” section on page 26.

NOTICE:

If the displayed error code is not listed in the chart, immediately turn off the water heater and call for service assistance.

Error Code	Possible Cause	Solution
1L	Water heater has buildup of lime deposits.	Contact a dealer or qualified service technician.
05	Air intake or vent exhaust opening may be blocked.	Remove any blockage. (Air intake requires 12 in. [30 cm] of clearance.)
	The vent pipes on the vent termination may not be connected properly.	Contact a dealer or qualified service technician.
11	The gas shut-off valve is not fully opened.	Check shut-off valve and open completely.
12	Gas service has been interrupted.	Contact your gas utility company.
	LP gas is running low (LP models only).	Refill or replace your LP gas container.
13	If this code is still displayed after taking the numbered steps above.	Contact a dealer or qualified service technician.
14	Water heater is overheating.	Contact a dealer or qualified service technician.
15	The heat exchanger is too hot.	Check for blockage in the vent. Contact a dealer or qualified service technician.
31	Faulty inlet thermistor.	Contact a dealer or qualified service technician.
33	Faulty outlet thermistor.	Contact a dealer or qualified service technician.

61 or 99	Faulty blower motor.	Contact a dealer or qualified service technician.
65	Faulty water flow solenoid.	Contact a dealer or qualified service technician.
P1	Not enough water flow to operate the unit.	Increase the water flow from the fixtures.
88	Reminder of flushing the heat exchanger and/or replacing the water treatment filter.	Contact a dealer or qualified service technician.

Warning

This content is compiled from multiple sources and is provided for reference purposes only. It may not be complete or fully applicable to all situations. If you are unable to resolve your issue, please contact the product manufacturer or an authorized service provider for official support.

