

Connections and Setup

TV Buttons

If the batteries in your remote control are run down, you can use the buttons on your TV set. They have the following functions:

For models with below buttons on the set:



For models with below buttons on the set:



For models with only one button on the set:

	TV mode	In menus
▲	P ▲	▲
▼	P ▼	▼
➤	🔊+	▶
➤	🔊-	◀
⏻	Features (Long press) OK (Short press)	Features (Long press) OK (Short press)

Initial Setup

The first time you switch the set on, the Welcome screen appears, which guides you through the initial setup process. Follow the on-screen instructions to finish the initial setup process such as selecting the language, connecting to the network, scanning channels, and more. During each step, either make a choice or skip the step. If you skip a step, you can perform the setup later from the settings menu.

Part 1, Google setup

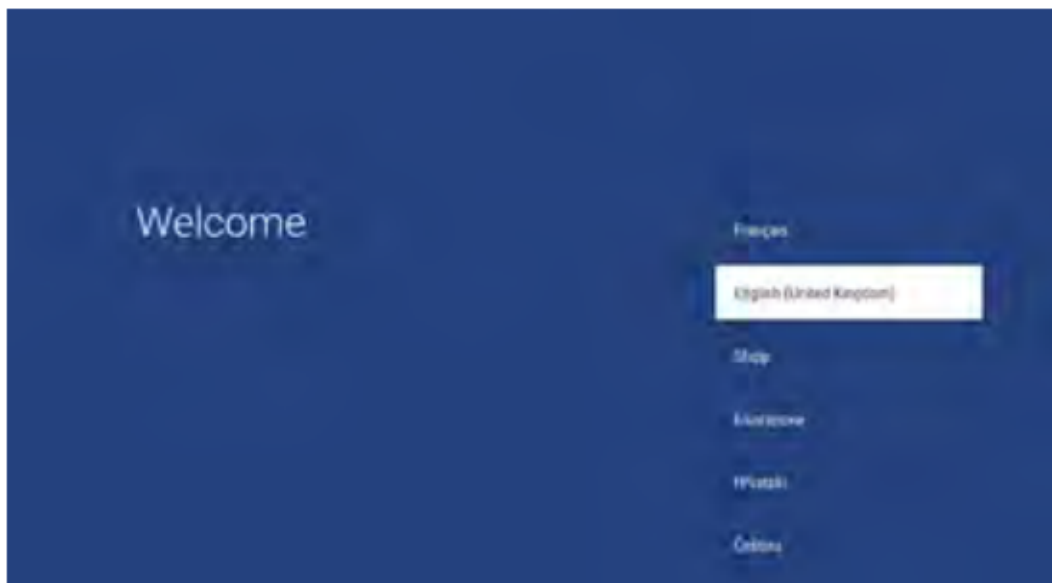

Do you have an Android phone or tablet?

Use an Android device (phone, tablet or other device) to set up TV with a few simple steps.

Yes

No

Select your Wi-Fi network

LEWFI

NANA/NANA_SG

HZ_SIK_JIK_SG

TP-LINK_VIP

TTTWR

TP-LINK_SL_20YJ3

TP-LINK_5

→ Skip

+ Other network...



Terms of Service & Privacy Policy

By installing you agree to the Google Terms of Service and Google Privacy Policy, and the Google Play Terms of Service.

This service may also receive and install updates and apps from Google and your device's manufacturer. Some apps may be downloaded and installed if you consent, and some may receive or allow their own processing of data.

Accept

[View Google Terms of Service](#)

[View Google Privacy Policy](#)

[View Google Play Terms of Service](#)





Part 2, TCL initial setup

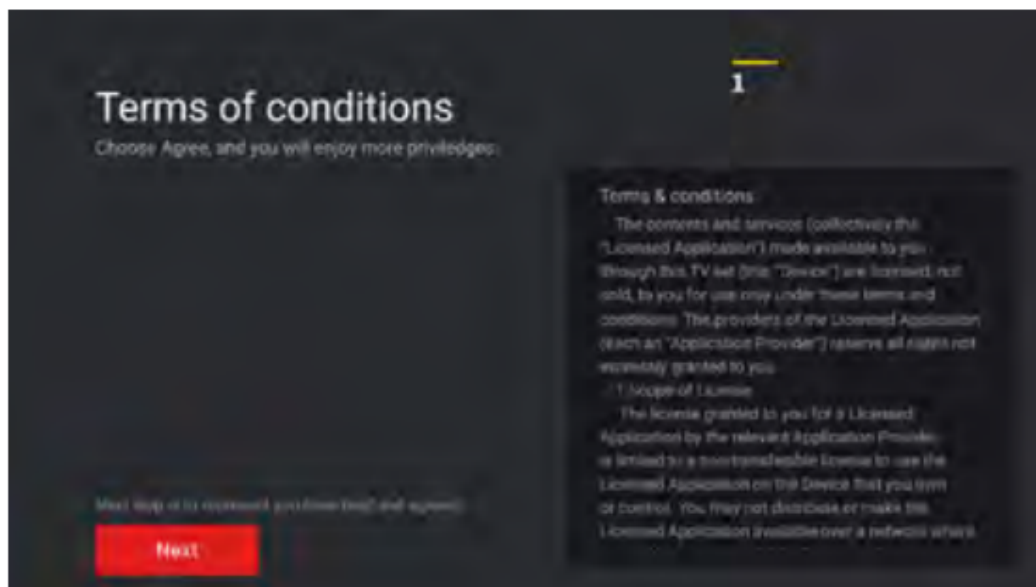

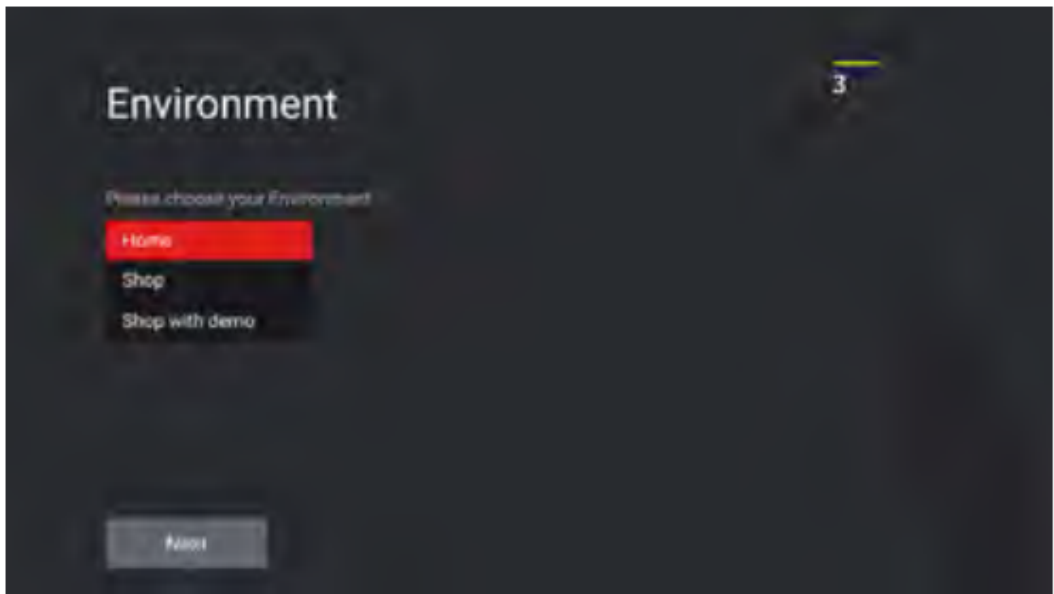
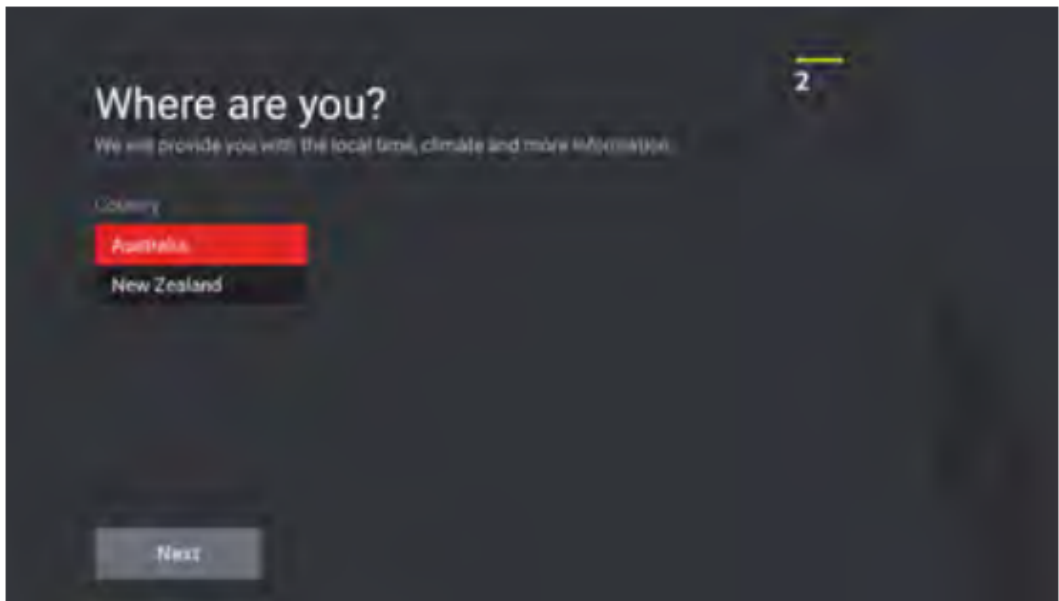

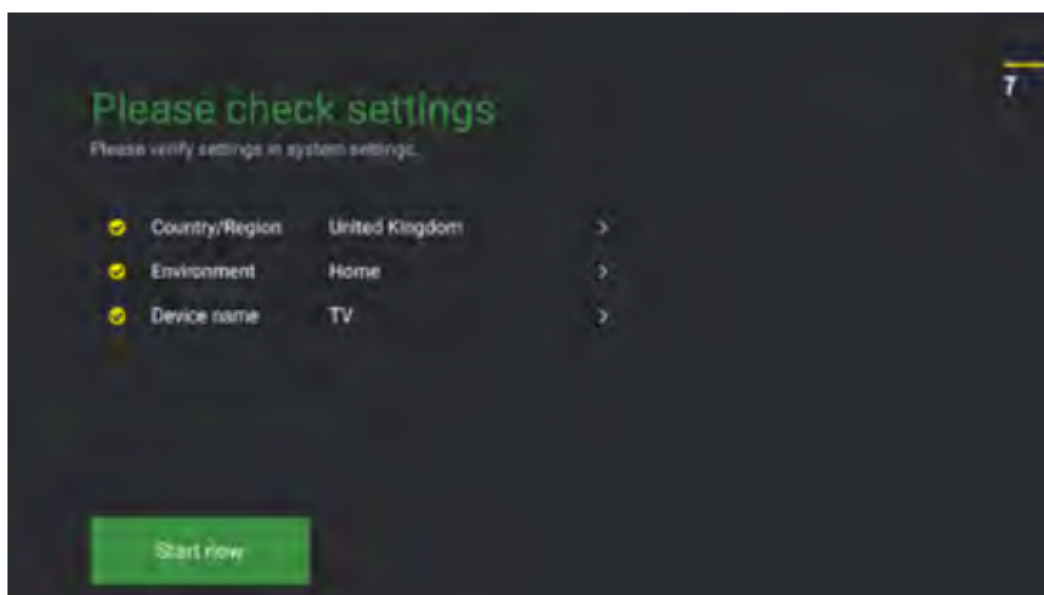
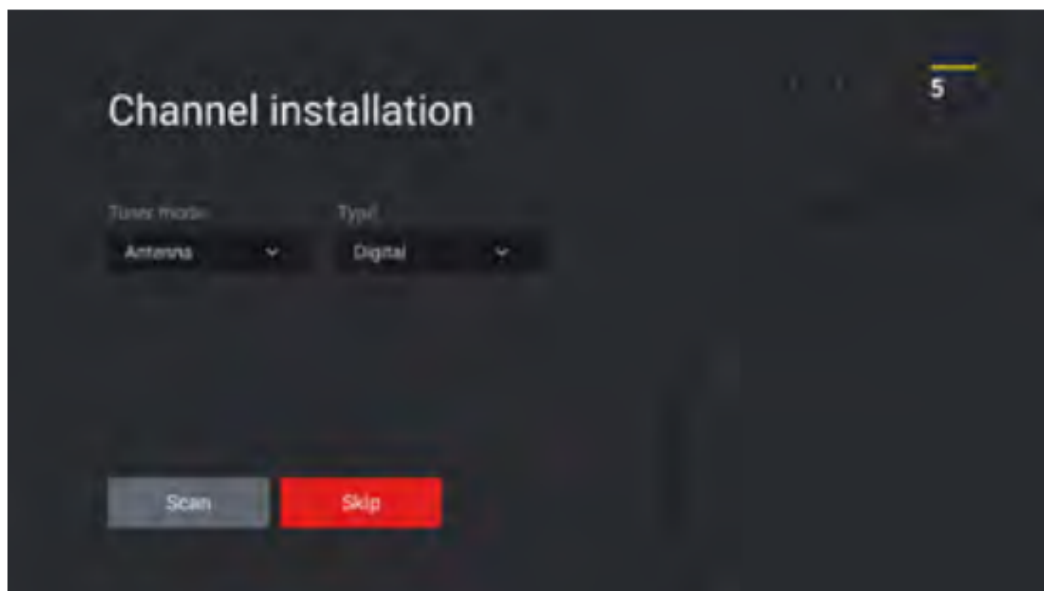

Sockets

USB 3.0 or USB2.0 or USB 2.0/SERVICE socket (input)

These sockets can be used to connect a USB device. Note: The number of USB sockets on the TV may vary according to TV model.

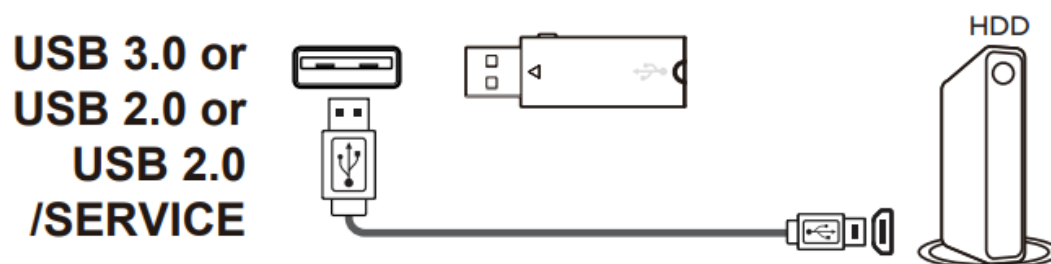

HDMI or HDMI(ARC) socket (input)

The HDMI (High-Definition Multimedia Interface) socket can be used to connect a Blu-ray player, PC with a compatible video card installed, certain DVD players or a high-definition compatible digital satellite decoder. This socket provides an uncompressed digital connection that carries both video and audio data by way of an integrated mini-plug cable.

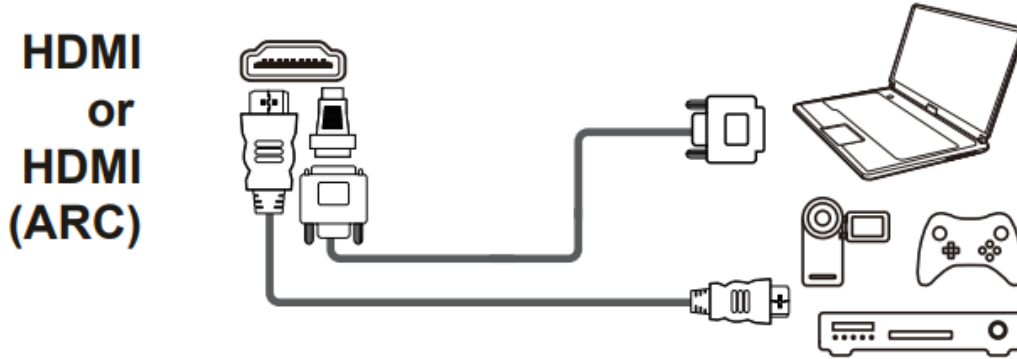

COMPONENT IN(YPBPR) socket (input)

These YPbPr sockets can be used to connect a device that has component video sockets, such as a DVD player. The component sockets can recognize if the device you're connecting to is Y Pb Pr compatible. The component sockets provide excellent picture quality because the video is separated into three independent parts.

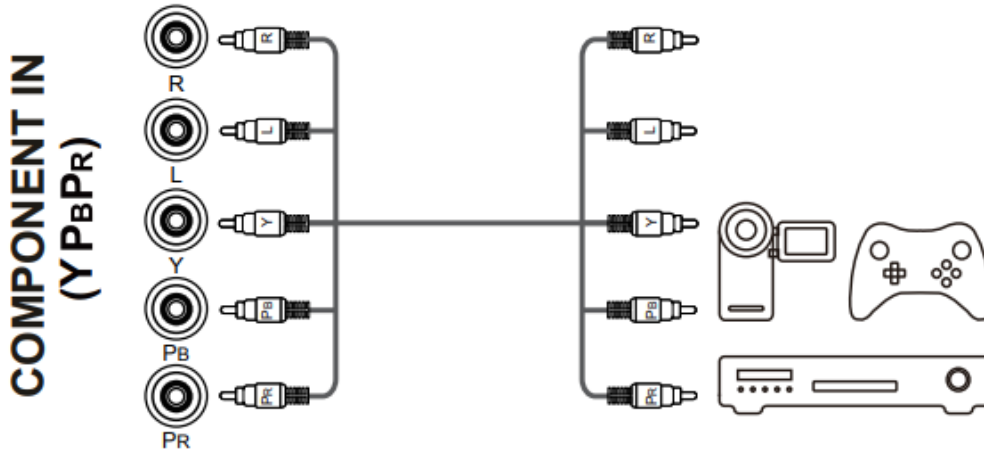

AV IN adapter socket

The AV IN adapter socket can be used to connect the attached AV adapter cable with VIDEO and AUDIO L & R IN sockets. The AV IN sockets can be used to connect a range of equipment, including video recorders, camcorders, decoders, satellite receivers, DVD players, or games consoles. The VIDEO IN socket provides composite video connection.



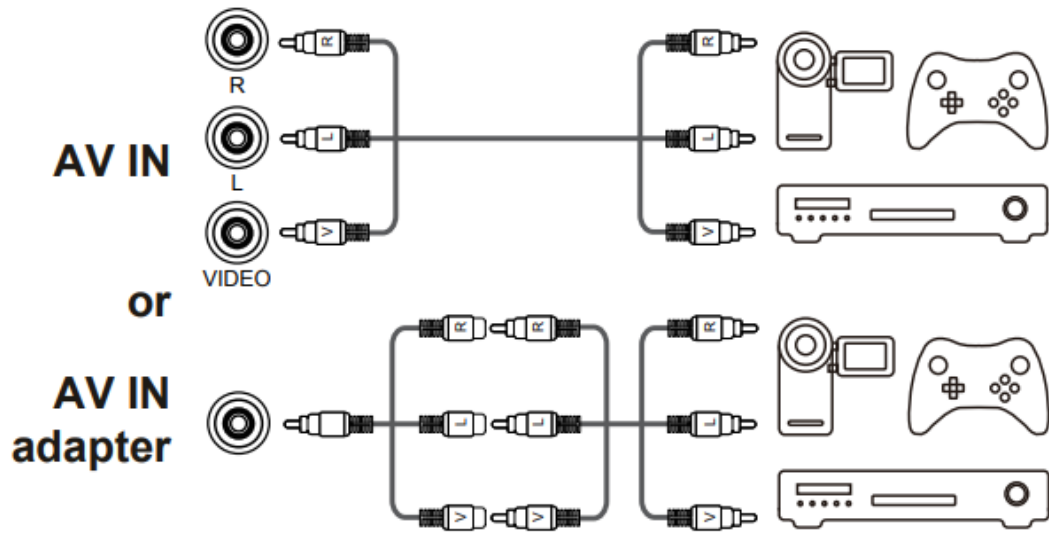

ANTENNA IN socket (input)

This socket can be used to connect an outside aerial.



LAN

RJ45 plug for connecting to external modem or network access equipment.

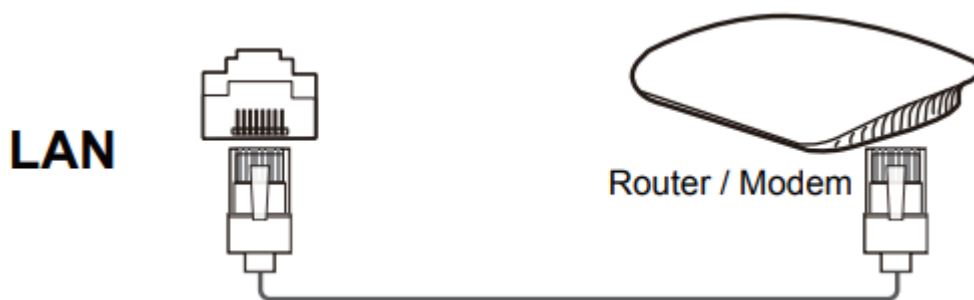

SPDIF socket (output)

The SPDIF socket can be used to connect a compatible digital audio receiver.





SPDIF

Headphone socket (output)

This socket can be used to connect headphones or stereo earphones.



Remote Control Functions

Most of your television's functions are available via the menus that appear on the screen. The remote control supplied with your set can be used to navigate through the menus and to configure all the general settings.





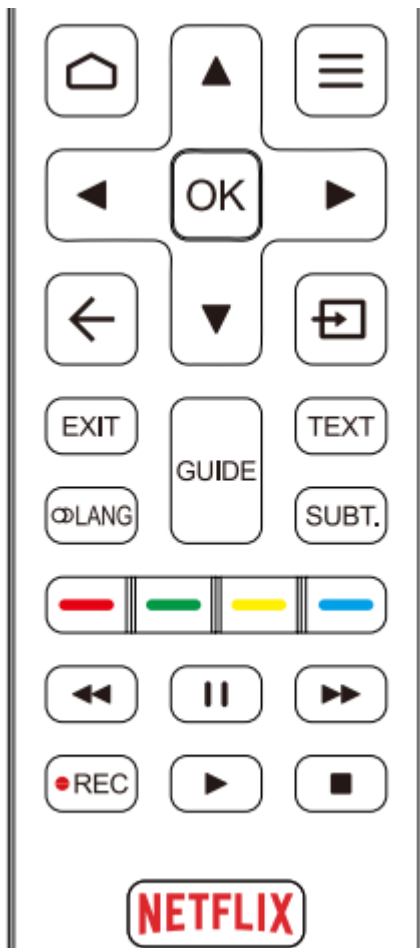

To switch the sound off and back on.



Standby / quit standby

Numeric buttons To enter channel numbers or a digit.



To access or exit T-Launcher.

LIST

To display the channel list.



To control the volume.





To display programme information, if available.



To display the Settings menu.

 To change channels.

 To access or exit the Smart TV homepage.

 To display the Option menu.

 Navigation direction buttons.

OK To confirm an entry or selection.

 To return to the previous menu or quit an App.

 To select input source.

EXIT To exit the Settings menu.

LANG To select an audio language available for selected digital TV programme.

GUIDE To toggle the Electronic Programme Guide on or off (only available for digital channels).

TEXT To toggle Teletext on or off.

SUBT. To select a subtitle language available for selected digital TV programme

Colour buttons To select tasks or Teletext pages; to be used for HbbTV function.

 To start fast reverse.

 To pause playback.

 To start fast forward

REC To record programmes under DTV source.

 To start playback.

 To stop playback

NETFLIX To access the NETFLIX application. (Not available for some models.)

Installing Batteries

1. Push to open the back cover as illustrated.
2. Insert two AAA batteries according to the polarities marked on the battery case.
3. Replace the back cover as illustrated

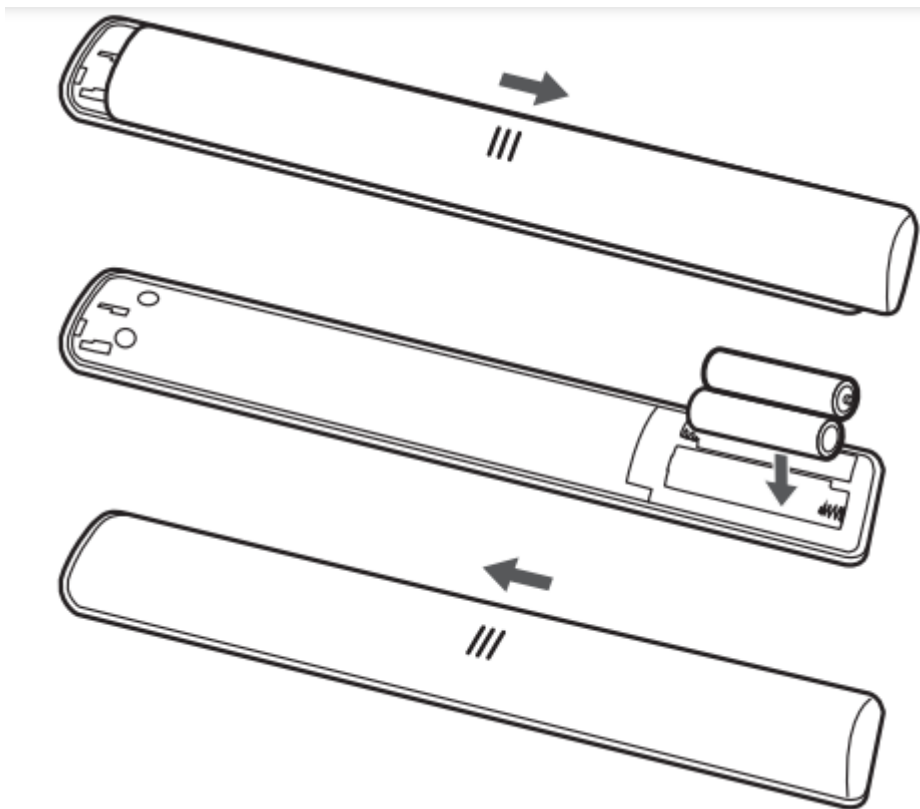

Exclusive Remote Control

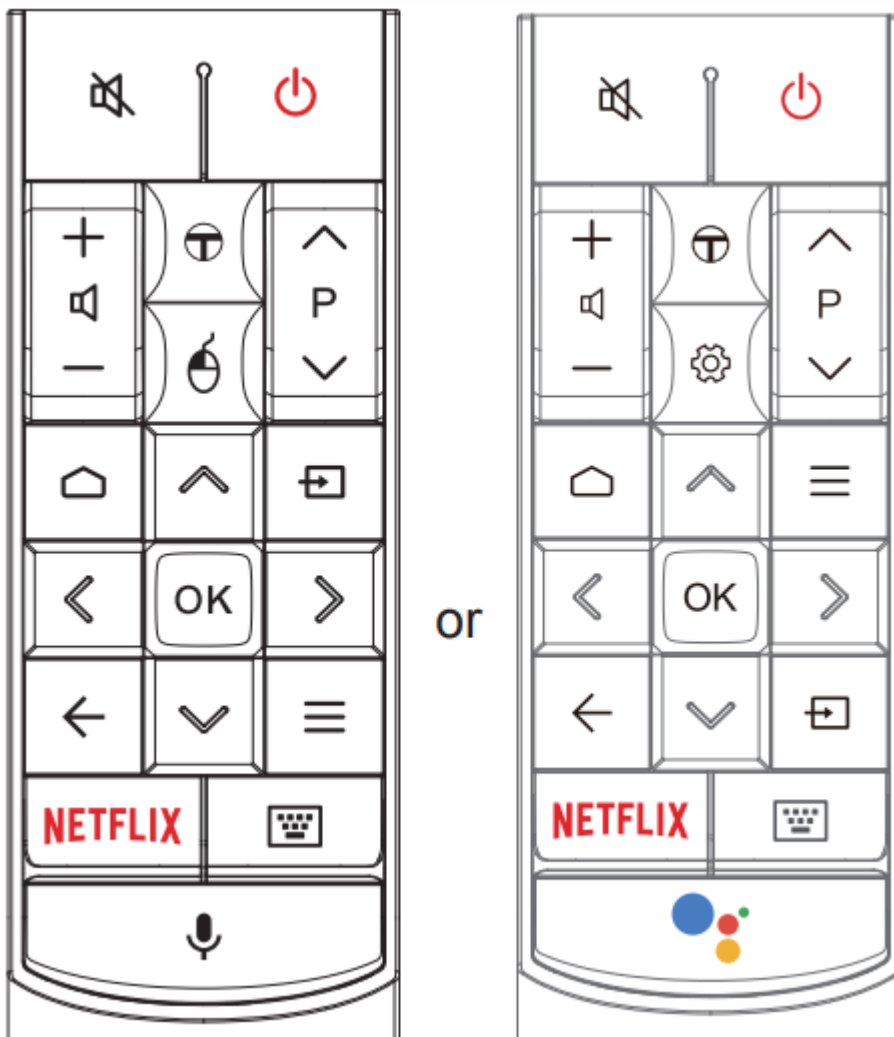

or



To switch the sound off and back on.



Standby / quit standby

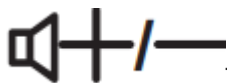

To control the volume.



To access or exit T-Launcher.





To turn on the mouse function.



To display the Settings menu.

 To change channels.

 To access or exit the Smart TV homepage.

 To select input source.

 Navigation direction buttons.

OK To confirm an entry or selection.

 To return to the previous menu or quit an App.

 To display the Option menu.

NETFLIX To access Netflix.

 To pop up the virtual remote control keyboard when available.

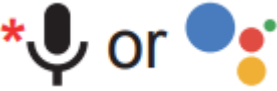
 To turn on the voice function. (Available only when the network connection is normal.)

How to use the remote control

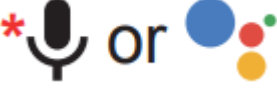
When using  or  button for the first time, you will be prompted to pair the remote with the TV. Please follow the on-screen guide for pairing instructions.

a. Keep the remote control and TV in 1 meter, press **OK** and  button on the

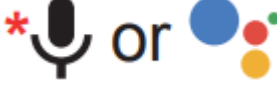
remote at the same time. You can use  or  button after activating successfully.

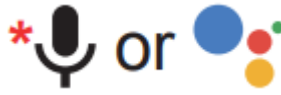

b. This voice search function from certain apps.

is only available for content search

c. Set languages in the TV settings to your local language or official language to enhance voice search successfully

Installing batteries

1. Hold the bottom part of the remote control, use a plastic coin-shaped object to twist the switch to the “Open” location as illustrated.
2. Pull out the battery cover.
3. Insert two AAA batteries according to the polarities marked on the battery case.
4. Replace the battery cover and use a plastic coin-shaped object to twist the switch to the “Close” location.

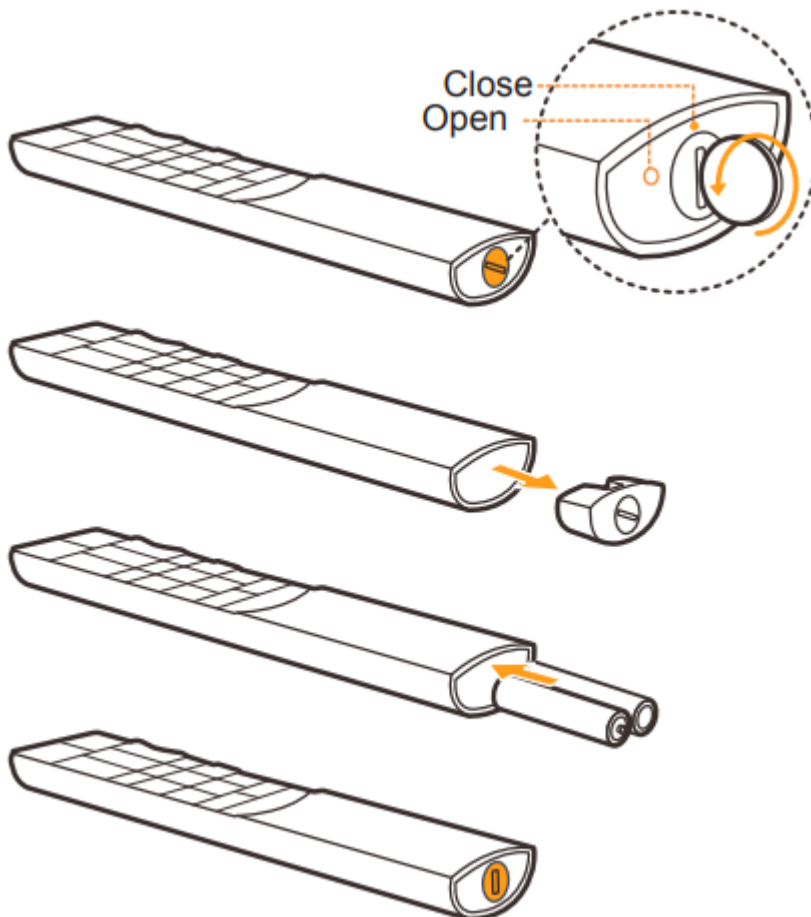

Network Connection

To connect to a wired network:

1. Ensure you have:

- An Ethernet cable long enough to reach your TV
- A router or modem with an available Ethernet port
- A high-speed internet connection
- An Ethernet (LAN) port on the back of the TV

2. Connect your Ethernet cable to the router and to the Ethernet port on the back of the TV.

3. Use the Network Settings to configure the TV.

Connecting to a wireless network

To connect to a wireless network

1. Ensure you have:

- A router broadcasting a high-speed wireless signal
- A high-speed internet connection

2. Use the Network Settings to configure the TV.

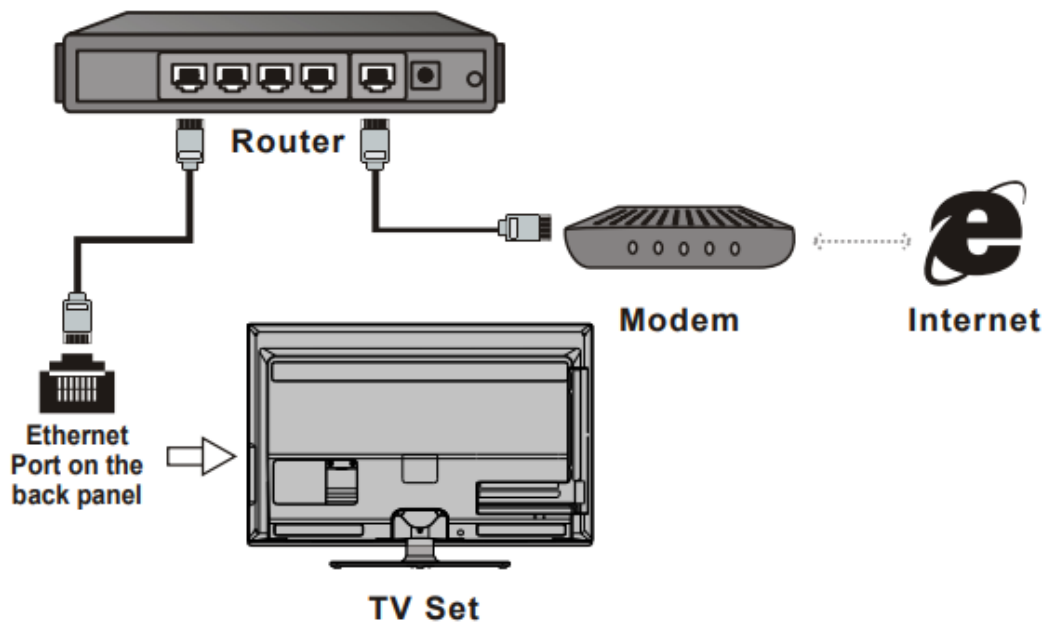

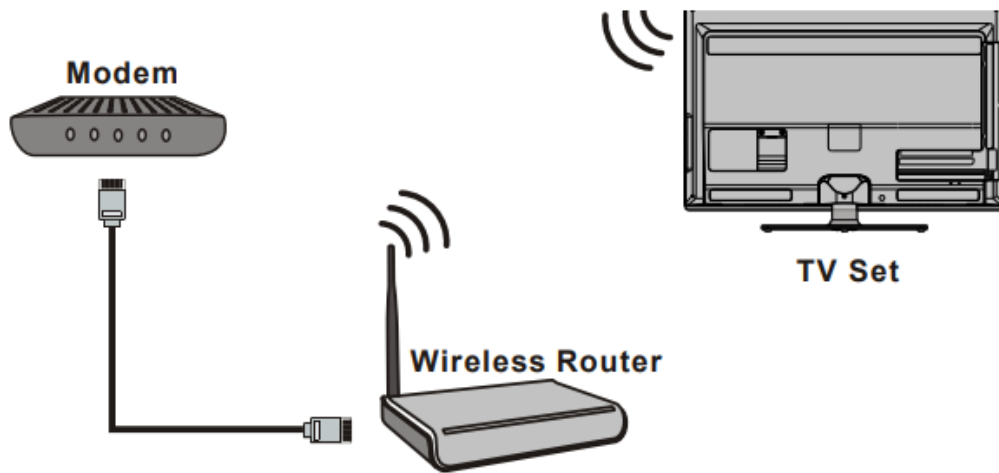

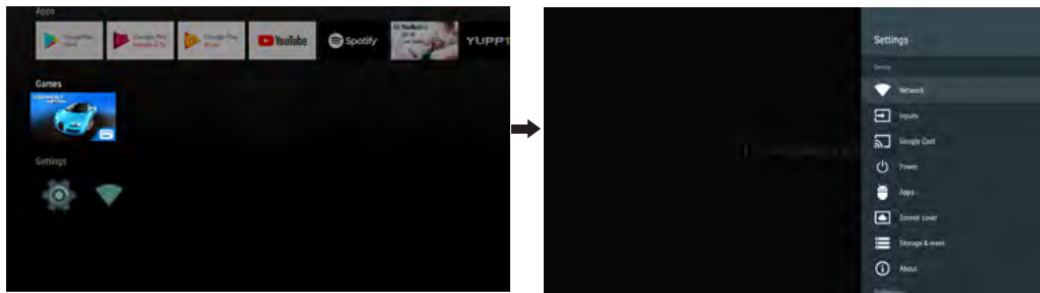

Network Settings

After you connect your home network to the TV, follow the steps below to configure the network settings of your TV. Note: the wireless network connection won't work if your TV is already connected to a wired network.



Connecting to a wireless network

1. Press  on the remote control. The Smart TV homepage is displayed.
2. Press ▲/▼ to move to the Settings area, select Settings and press OK to enter.
3. Move to the Device area, select Network and press OK to enter. The Network menu is displayed.
4. Select Wi-Fi and press OK to enter.
5. Set Wi-Fi to On. All available wireless networks will be displayed.
6. Press ▲/▼ to highlight the name of your wireless network and press OK.
7. Using the on-screen keyboard and the remote, enter your network's password, then highlight Enter on the onscreen keyboard and press OK. Once connected, the wireless network will be saved. Next time when you connect to the same network, you do not have to re-enter the password.

8. Press  to close the menu and return to the Smart TV homepage.

Connecting to a wired network

1. From the Network menu, select Ethernet and press OK to enter.
2. Press ▲/▼ to select Proxy settings and press OK.
3. Select MANUAL, using the on-screen keyboard and the remote, enter your network's proxy information step by step.
4. Press ▲/▼ to select IP settings and press OK.
5. Select DHCP or STATIC. If you select STATIC, you must enter your network's IP address, gateway, network prefix length, DNS1, and DNS2 step by step.
6. Press  to close the menu and return to the Smart TV homepage.

Detecting your network status

1. From the Network menu, select Network Detection and press OK to enter.
2. The Network Detection screen displays the connection method of your network connection.
3. Press  to close the menu and return to the Smart TV homepage

Switching on

Follow the instructions on this page on how to switch on your TV set and the remote control before going on to following pages describing how to use the channel set-up procedure.

1. Insert two AAA batteries in the remote control. Precautions on using batteries:
 - Only use the battery types specified.
 - Make sure you use the correct polarity.
 - Do not mix new and used batteries.
 - Do not use rechargeable batteries.
 - Do not expose batteries to excessive heat such as sunshine, fire or similar, throw them in a fire, recharge them or try to open them, as this could cause them to leak or explode.
 - Remove the batteries from the remote control if you are not using it for a long period of time.
 - Attention should be drawn to the environmental aspects of battery disposal.

2. Connect the power cable to a mains socket. (If the power cable is not connected to the television, please first connect the power cable to the television.) Your TV set should only be connected to an AC supply. It must not be connected to a DC supply. If the plug is detached from the cable, do not, under any circumstances, connect it to a mains socket, as there is a risk of electric shock.

3. Connect the outside aerial or cable network to the Antenna input socket at the back of the TV set. The aerial socket (75 OHM - VHF / UHF / cable) can be used for connecting an external aerial or other equipment fitted with a modulator (video recorder, satellite receiver, etc.). We recommend that you do not connect other equipment (video recorder, satellite receiver, etc.) to your TV set to begin with, so as not to complicate the set-up procedure with the additional steps involved. Connect them when you have finished setting up the channels.

4. When powered on, the TV will be turned on directly or be in standby mode. If the TV set is in standby mode, press the standby button on the remote control or on the TV set to turn on the TV.

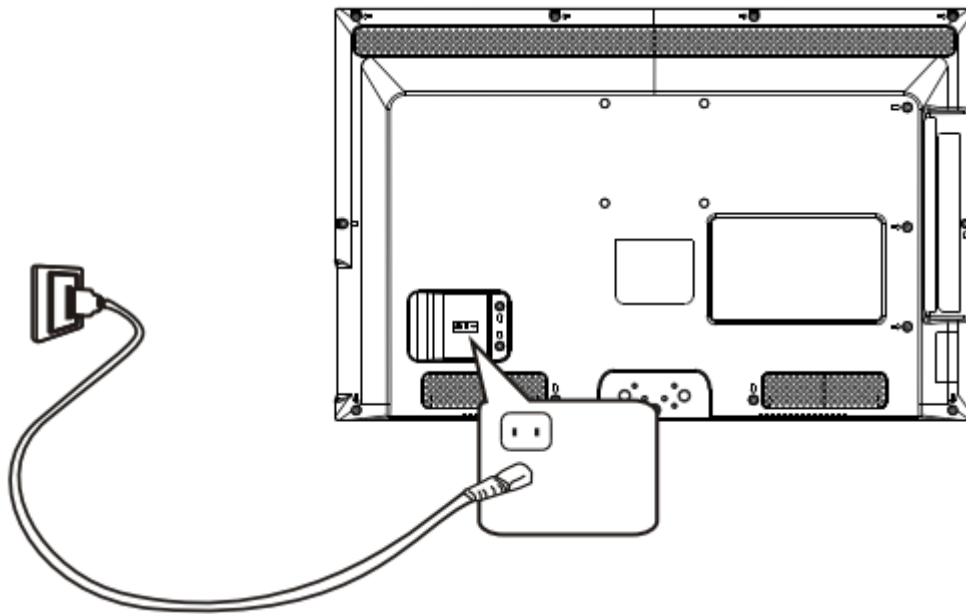

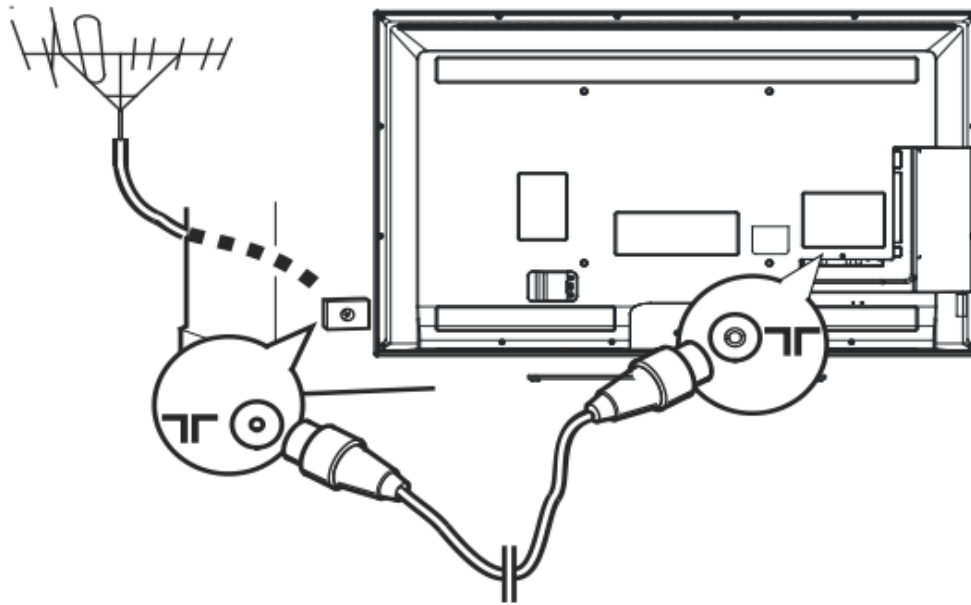

Switching off









To put the TV set into standby mode, press  on the remote control or on the TV, the TV set remains powered up, but with low energy consumption. To switch off the TV set, disconnect the mains plug from the mains outlet.

Basic TV Operations

Accessing Channels





Using the numeric buttons: press the corresponding numeric buttons on the remote control to access the channels.

Using the  buttons: press the  buttons on the remote control or the corresponding buttons on the TV set to scroll through the channels.

Using the LIST button: press the LIST button on the remote control to display the channel list and press /// and OK to select channels.



Watching Connected Devices

Press  on the remote control to display the source list. Press / to select

TV or other input sources and press OK to confirm. You can also press  on the remote control to display the homepage, press / to move to the Sources area, then press / and OK to select the input source.

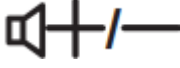
Adjusting Volume

Volume control: press the  buttons on the remote control or the corresponding buttons on the TV set to increase or decrease the volume.



Sound mute: press the  button to temporarily mute the sound. Press this button again or the  button to restore the sound.

Accessing Smart TV Homepage

Allows you to enjoy Internet Applications (Apps) and specially adapted Internet websites, and perform system settings for your TV. You can make controlling with the TV remote control.



- According to circumstances of the content provider, an application's updates or the application itself may be discontinued.
- Depending on your country's regulations, some applications may have limited service or not be supported.
- Changes in application content may be made without prior notice by the service provider.



1. Press  on the remote control to display the Smart TV homepage.
2. Press  and OK to enter the desired Apps, functions or settings.
3. Press  to return to the homepage.

4. To exit the homepage, use ▲/▼/◀/▶ to move to the source you'd like to choose, then press OK to enter.

Accessing T-Launcher

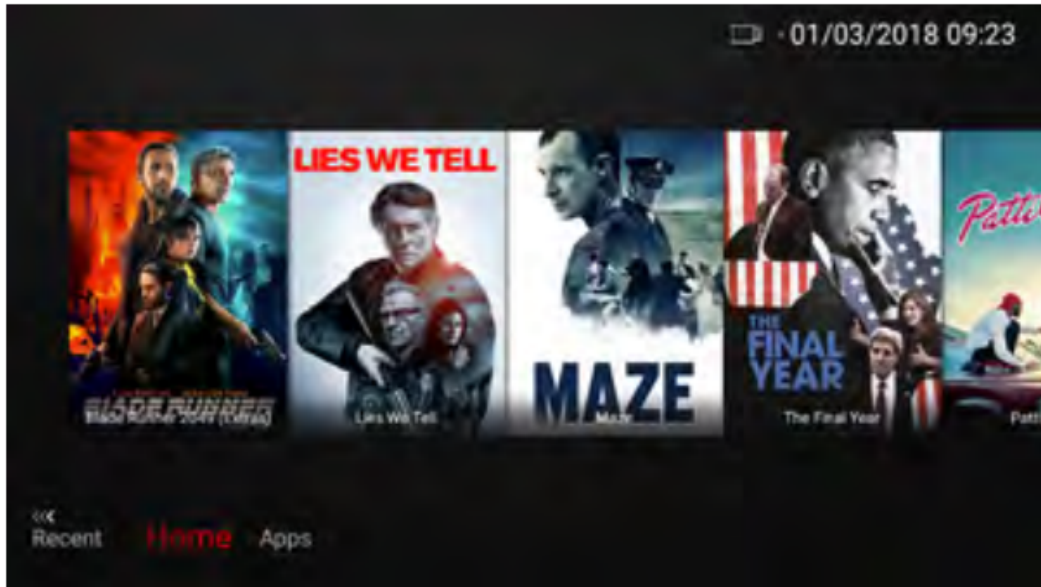
Allows you to enjoy Internet Applications (Apps)





1. Press  on the remote control to display the T-Launcher.
2. Press ▲/▼/◀/▶ and OK to enter the desired Apps.
3. Press  to return to the launcher.
4. Press  again to exit the T-Launcher.

Using Google Settings

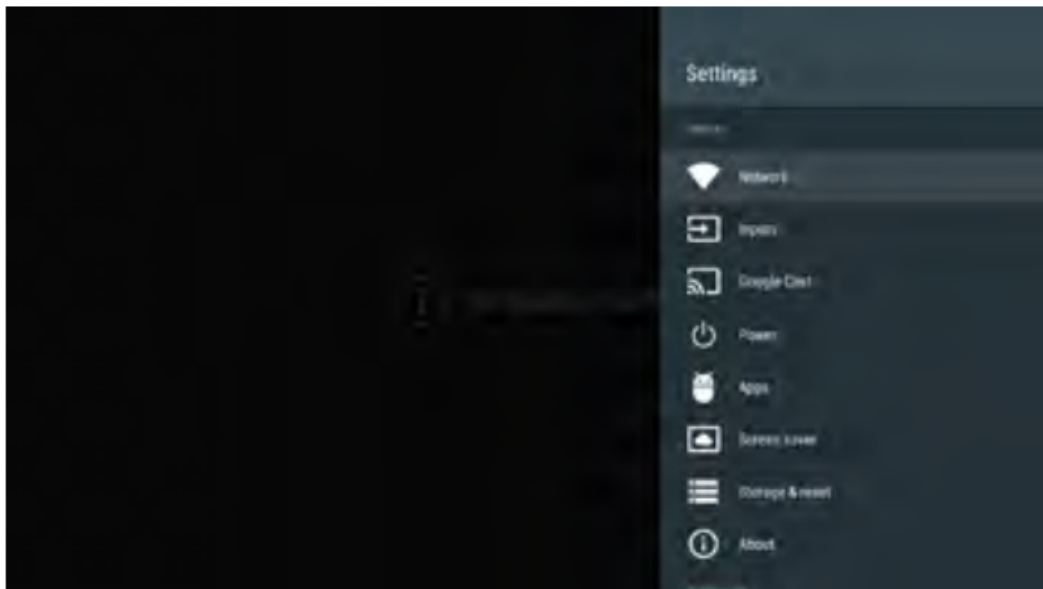
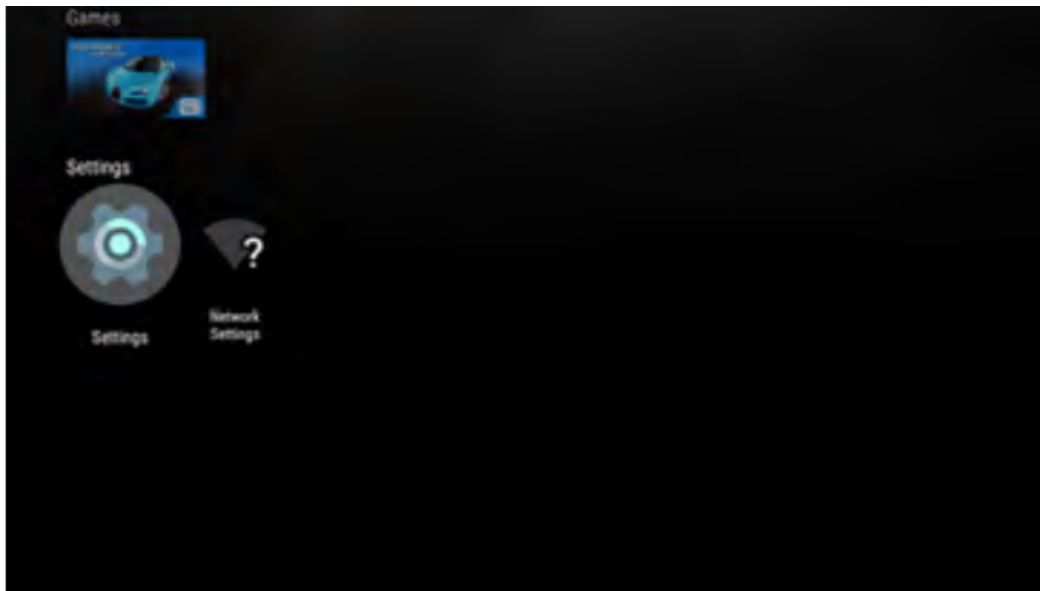
Allows you to not only adjust device settings, such as network, inputs, Google Cast and apps, etc., but also set preferences



1. Press  on the remote control to display the Smart TV homepage.
2. Press $\blacktriangle/\blacktriangledown/\blacktriangleleft/\blacktriangleright$ to select Settings and press OK to enter the Google settings.
3. Press $\blacktriangle/\blacktriangledown$ to choose the items and press OK to enter.
4. Press  to return to previous interface.
5. Press EXIT to close the menu.

Using Instant Power On

It enables you to turn on your TV within 5 seconds from standby mode.

1. Press  on the remote control to display the homepage, Press $\blacktriangle/\blacktriangledown/\blacktriangleleft/\blacktriangleright$ to select Settings > Device > Power > Instant power on and press OK.

2. Press ▲/▼ to select On and press OK to confirm.

3. Press  to return to the homepage

Using TV Settings menu

Allows you to adjust TV settings, such as picture and sound



1. Press  on the remote control to display the Settings menu.
2. Press ▲/▼ to select the desired item, then press OK/▶ to enter the corresponding submenu.

Using more of your TV

Installing Channels

This section describes how to search and store channels automatically. This may be done in any of the cases below:

- you have skipped the channel installation step in the initial setup;
- you are prompted that there are no channels in TV mode;
- you want to update your channels.

1. In TV mode, press  on the remote control and select Channel > Channel scan. Press OK/▶ to enter.
2. The TV installs and arranges channels according to your country or region. Press ▲/▼ to select Country/Region, and press OK/▶ to enter. Enter the default password

1234 or your own password in case you have changed the password in the System > Lock menu. Press ▲/▼ to select your country or region and press OK to confirm.

3. Press ▲/▼ to select Automatic search and press OK/▶ to enter.

4. Press ▲/▼ to select Channel type and press ◀/▶ to select Digital, Analogue or Digital&Analogue.

5. After configuration is completed, press ▼ to select Search and press OK to start scanning channels.

6. The channel search may take a few minutes. After the automatic search, channels

are arranged in a preset order. If you wish to hide or move channels, press  on the remote control, select Channel > Channel organizer and press OK/▶ to enter.

Using Subtitles

You can enable subtitles for each TV channel. Subtitles are broadcast via Teletext or DVB-T digital broadcasts. With digital broadcasts, you have the additional option of selecting a preferred subtitle language.

Turning on/off subtitles

1. Press  on the remote control, select Channel > Subtitle and press OK/▶ to enter.

2. Select the Subtitle option, press OK/▶ to enter, press ▲/▼ to select On or Off and press OK to confirm.

3. Press EXIT or  to close the menu.

Enabling subtitle languages on digital TV channels

1. Press  on the remote control, select Channel > Subtitle > Digital subtitle language 1st and press OK/▶ to enter.

2. Press ▲/▼ to select a subtitle language as your preferred language and press OK to confirm.



3. Press ▲/▼ to select Digital subtitle language 2nd and press OK/▶ to enter

4. Press ▲/▼ to select a secondary subtitle language and press OK to confirm.

5. Press EXIT or  to close the menu.



Shortcut operation: Press SUBT. on the remote control to directly select a subtitle language available for the selected digital TV programme.

Selecting a subtitle type on digital TV channels

1. Press  on the remote control, select Channel > Subtitle > Subtitle type and press OK/▶ to enter.
2. Press ▲/▼ to select a subtitle type and press OK to confirm. You can select Hearing impaired to display the hearing impaired subtitles with your selected language.
3. Press EXIT or  to close the menu.



Using Teletext

Selecting decoding page language

1. Press  on the remote control, select Channel > Teletext > Decoding page language and press OK/▶ to enter.
2. Press ▲/▼ to select a proper type of language in which Teletext will display and press OK to confirm.
3. Press EXIT or  to close the menu.

Digital Teletext language

On digital TV channels, depending on the broadcaster, you may be able to enjoy a service with multiple initial Teletext pages in different languages. This function allows you to select an available language as primary language, which relates to different initial Teletext pages.

1. Press  on the remote control, select Channel > Teletext > Digital teletext language and press OK/▶ to enter.
2. Press ▲/▼ to select a language and press OK to confirm.
3. Press EXIT or  to close the menu.

Network waking up

This function allows you to turn on your TV from standby mode via a network. To use this function, please make sure:

1. Your TV is connected to an effective home network;
2. The desired controller, such as a smartphone, is connected to the same network as your TV;



3. An App which supports network waking up function, has been installed into the controller;
4. Networked standby is set to On in the Network menu.

When the TV is in networked standby mode, you can use the App to wake up the TV remotely

T-Link

Use this function to search for CEC devices connected to the HDMI sockets in your TV and enable auto power on and auto standby between the TV and CEC devices.

Enabling or disabling T-Link

1. Press  on the remote control, select System > T-Link and press OK/▶ to enter.
2. Press ▲/▼ to select On or Off and press OK to confirm.
3. Press EXIT or  to close the menu.

Using Auto Power on

Enables the TV to automatically power on when you power on a CEC device (e.g. DVD) with the device's remote. Select On to enable this function.

Using Auto Standby

Enables all CEC devices to automatically go to the standby mode when you turn off the TV with the TV remote. Select On to enable this function.

Note: The CEC functions depend on the devices connected and it is possible that some devices may not interoperate correctly when connected to this TV. The user manual or the manufacturer of the problematic devices should be consulted for further information.

Time Shift

Allows you to pause, fast forward and rewind live TV, so you don't have to miss any part of your favourite programmes. Before you use the function, connect a USB drive to the TV first. For the first time, you should complete the disk setup for the USB drive.

1. Press  on the remote control and select Time Shift, then press OK/▶ to confirm.
2. Follow the directions on the screen to do the disk setup if you use time shift for the first time.

3. After the disk setup is done, time shift will start, and the time shift menu displays on the screen. For later use, press  and select Time Shift. press OK/▶ to display the time shift menu and operate according to the on-screen prompt.

4. Pressing  button stops the time shift and exits.

- When the time shift menu disappears and only the timing of the time shift remains on the screen, you can press OK to call out the time shift menu

- The bigger the USB drive free space for time shift, the bigger the recording length.

Quick Access of Time Shift: Insert a USB disk, press PAUSE  on the remote control, it will access Time Shift automatically.

HbbTV

HbbTV (Hybrid broadcast broadband TV) is a service offered by certain broadcasters and available only on some digital TV channels. HbbTV delivers interactive television over broadband Internet. These interactive features are added to and enrich the normal digital programmes, and include services such as digital teletext, electronic programme guide, games, voting, specific information related to the current programme, interactive advertising, information magazines, catch-up TV, etc. To use HbbTV please ensure your TV is connected to Internet and HbbTV is switched on.

Notes:

- HbbTV services are broadcast- or countrydependent and may be unavailable in your area.

- You cannot download files to your TV with HbbTV function.

- Application provider or broadcasting related conditions may cause an HbbTV application to be unavailable momentarily.

- To access HbbTV applications you must connect your TV to the Internet via a broadband link. HbbTV applications may not work correctly in case of network related issues.

HbbTV access

1. Press  on the remote control, select System > Advanced settings > HbbTV and press OK/▶ to enter.

2. Press ▲/▼ to select On and press OK to confirm.
3. When you tune to a digital TV channel that offers HbbTV, this will be signaled to you by an on-screen indication (generally a red button, but other colour buttons may also be used). Press the indicated colour button to open the interactive pages.
4. Use ▲/▼/◀/▶ and the colour buttons to navigate through the HbbTV pages and press OK to confirm.

HbbTV deactivation

To avoid disturbances that may be caused by HbbTV broadcasting tests, you can turn off the HbbTV function:

1. Press  on the remote control, select System > Advanced settings > HbbTV and press OK/▶ to enter.
2. Press ▲/▼ to select Off and press OK to confirm.

Google Cast

Google Cast™ lets you cast your favorite videos, games, and apps from your mobile device, in full quality, to your TV. Just one tap of the Cast button on your Android or iOS screen is all you need to supersize the things you love. Cast your content then continue browsing on your phone or tablet.



T-Cast

T-Cast lets you enjoy plenty of videos, rich of applications by scanning the QR code on the TV screen and downloading T-Cast.



PVR(Personal Video Recorder)

Allows you to record your favourite TV programmes. Before you use the function, connect a USB drive to the TV first.

1. Press  on the remote control and select PVR.
2. Press OK/▶ to enter and select Record. It starts to record automatically.
3. Press BLUE button on the remote control and use ▲/▼/◀/▶ to adjust the recording duration.
4. Press OK/ to stop recording manually, the recorded file will be saved. In normal operation, the recording will stop automatically when the recording duration expires.
5. In recording, the PVR mini pane will also show on the screen to indicate the recording progress.
6. To watch the recorded programme, exit PVR mode first, Press  and select PVR > PVR List, then select the related record file. Press OK to play. (It is the same if you record a digital radio programme)

Using EPG (Electronic Programme Guide)

EPG is an on-screen guide that displays scheduled digital TV programmes. You can navigate, select and view programmes.

Note: The DTV EPG does not require an internet connection. To use the DTV EPG, HbbTV must be set to Off. when HbbTV is set to ON, then it will enter the HbbTV EPG directly. Please refer to “ HbbTV ” part of this manual for assistance to set HbbTV to on or off.

1. Press GUIDE on the remote control, the Program Guide menu will appear, which allows you to get information about the current or next programme playing on each channel. Navigate through the different programmes using the ▲/▼/◀/▶ buttons on the remote control.
2. Use the related buttons shown at the bottom of the screen to view EPG.
 - Program filter: Programme guide filter for digital TV programmes.
 - Press to display the type list of the programme.
 - Navigate through the different types using the ▲/▼ buttons on the remote control.
 - Select one or more types, which you want to highlight from the type list, press OK to select or deselect. A checkmark will appear to the right of the type when selected.

- Custom schedule: Press ▲/▼ to select a programme, then press the RED button to set the schedule. Use the ▲/▼ buttons to select Schedule reminder or Schedule recording , then press OK to enter.
- Select date: Press the GREEN button to select date.
- Schedule list: Press the YELLOW button to view your schedule list.

3. Press GUIDE or EXIT to exit EPG.

Bluetooth Function

(* not available for some models) Bluetooth® is a wireless technology standard for exchanging data over short distance between Bluetooth devices. You can connect Bluetooth audio device, mouse or keyboard via the TV.

1. Press  on the remote control, move to the Settings area, select Settings and press OK to enter.
2. Move to the Remote & accessories area, select Add accessory and press OK to enter. The TV will search nearby Bluetooth devices automatically.
3. Select an available device, press OK and follow the guides on the screen to connect it.

The Bluetooth word mark and logos are registered trademarks owned by Bluetooth SIG, Inc. and any use of such marks by TCL is under license. Other trademarks and trade names are those of their respective owners.

Freeview Plus

Freeview Plus is a new television service which provides a state of the art EPG and seamless access to Catch Up TV from free-to-air networks with the simple press of a button. Freeview Plus provides an unrivalled user experience and places free to air television at the forefront of innovation, with services that include:

- A 7-day, easy-to-use EPG
- All available Catch Up TV on the TV screen
- Featured recommendations
- Ability to browse by genre and search programmes for the next 7 days
- A favourite function with reminders for live and Catch Up programmes

What you need

You need a high-speed (broadband) internet connection to the TV.

To launch Freeview Plus

When you are watching TV, you will briefly see a prompt at the top left of the screen. Press the corresponding colour key on the remote control to launch Freeview Plus. Follow the on-screen instructions and use the colour keys, arrow keys, and OK button to navigate.

*Freeview Plus uses HbbTV technology which combines broadcast and broadband. Internet connection is required. Data usage and conditions apply.

**Freeview Plus is available through out Australia but Catch Up services vary by region – please check web to see what’s available in your area.

***More information about Freeview Plus can be found on the web

Netflix settings

Netflix provides on-demand movies and TV shows delivered via the Internet. Netflix is available in certain countries. Unlimited membership is required. More information can be found at web

Note: you can directly access Netflix via clicking the Netflix button on the remote control.

Password in Parental Control

- The default password is 1234. You can change it to a new one.
- The super password is 0423. If you forget your code, enter the super password to override any existing codes.

Problems & Solutions

1. Fail to link to the network.

- Check if your TV is connected with the network;
- Reboot your TV;
- Consult your internet service provider, to confirm if access of your router is supported. Refer to the operation manual of your router.
- Make sure your TV is connected to a router, and make sure your router is powered on. Check that your router/modem has an internet connection, and that your Ethernet cables/wireless connection is OK. Test your connection with a computer to make sure it is OK. Should the problem persist, contact customer service.

2. The video could not be played smoothly.

- Videos from your USB flash drive --- It may result from data transmission, or its code flow is far beyond the supported formats of this TV set.
- Videos downloaded from internet, or online videos.

- a. It may be caused by the lower bandwidth of your network. A high network speed is required to handle online videos.
- b. Peak internet usage times may affect the bandwidth.
- c. Check if any other computers on the same network are also operating, as they may be using up bandwidth. Especially if they are downloading or playing online videos.
- d. The video may not be smooth itself, it is not the problem of your TV or network.

3. When two mobile hard disks are connected with the TV at the same time, they will not be recognized some times.

- All mobile hard disks consume a lot of power, which may result in power supply problems. We recommend inserting only one hard disk, or a low power consumption mobile hard disk.

4. The video from a mobile hard disk (USB) is playing with no sound.

- The audio format of the video in your mobile hard disk is not supported by the TV player.

5. Some videos fail to play.

- The formats of the videos may not be supported by the TV, especially videos shot by certain kinds of cameras, generally with their private protocol of formats, which are not compatible with your TV.

6. Video stops playing midway.

- Mistakes may occur when videos are copied or compressed, so they may automatically stop playing during playback.

7. What should I pay attention to, when I do SW updating

- No power cuts when SW updating;
- Avoid any operations with your remote control when SW updating;
- Depending on your internet connection speed, the software updating process may take some time.

8. There are no distinct changes of TV interface after SW updating.

- Under certain conditions, SW updating may not only update or add new functions but also improve the performance of the TV set, without distinct changes to the user interface. Also, there may be no changes to the user interface at all.

9. Voice search does not work.

- Check if your remote control has been successfully paired with your TV.
- Check if the language setting is correct.

- Check if Google server is available and stable.

Troubleshooting

No picture, no sound

1. Check if the fuse or circuit breaker is working.
2. Plug another electrical device into the outlet to make sure it is working or turned on.
3. Power plug is in a bad contact with the outlet.
4. Check the signal source.

No colour

1. Change the colour system.
2. Adjust the saturation.
3. Try another channel. Black-white programme may be received.

Remote control does not work

1. Change the batteries.
2. Batteries are not installed correctly.
3. Main power is not connected.

No picture, normal sound

1. Adjust the brightness and contrast.
2. Broadcasting failure may happen.

Normal picture, no sound

1. Press the VOLUME UP button to increase volume.
2. Volume is set to mute, press the Mute button to restore sound.
3. Change the sound system.
4. Broadcasting failure may happen.

Unorderly ripples on the picture

It is usually caused by local interference, such as cars, daylight lamps and hair driers. Adjust the antenna to minimize the interference.

Snowy dots and interference

If the antenna is located in the fringe area of a television signal where the signal is weak, the picture may be marred by dots. When the signal is extremely weak, it may be necessary to install a special antenna to improve the reception.

1. Adjust the position and orientation of the indoor/ outdoor antenna.
2. Check the connection of antenna.
3. Fine tune the channel.
4. Try another channel. Broadcasting failure may happen.

Ignition

Black spots or horizontal streaks appear, or the picture flutters or drifts. This is usually caused by interference from car ignition system, neon lamps, electric drills, or other electrical appliance.

Ghost

Ghosts are caused by the television signal following two paths. One is the direct path, the other is reflected from tall buildings, hills, or other objects. Changing the direction or position of the antenna may improve the reception.

Radio frequency interference

This interference produces moving ripples or diagonal streaks, and in some case, loss of contrast in the picture. Find out and remove the radio interference source.

*To bring you better visual experience, please remove all labels, if any, from TV front panel and screen before use.

*Figures and illustrations in this User Manual are provided for reference only and may differ from actual product appearance. Product design and specifications may be changed without notice.

Warning

This content is compiled from multiple sources and is provided for reference purposes only. It may not be complete or fully applicable to all situations. If you are unable to resolve your issue, please contact the product manufacturer or an authorized service provider for official support.