

PARTS AND ACCESSORIES

Remote

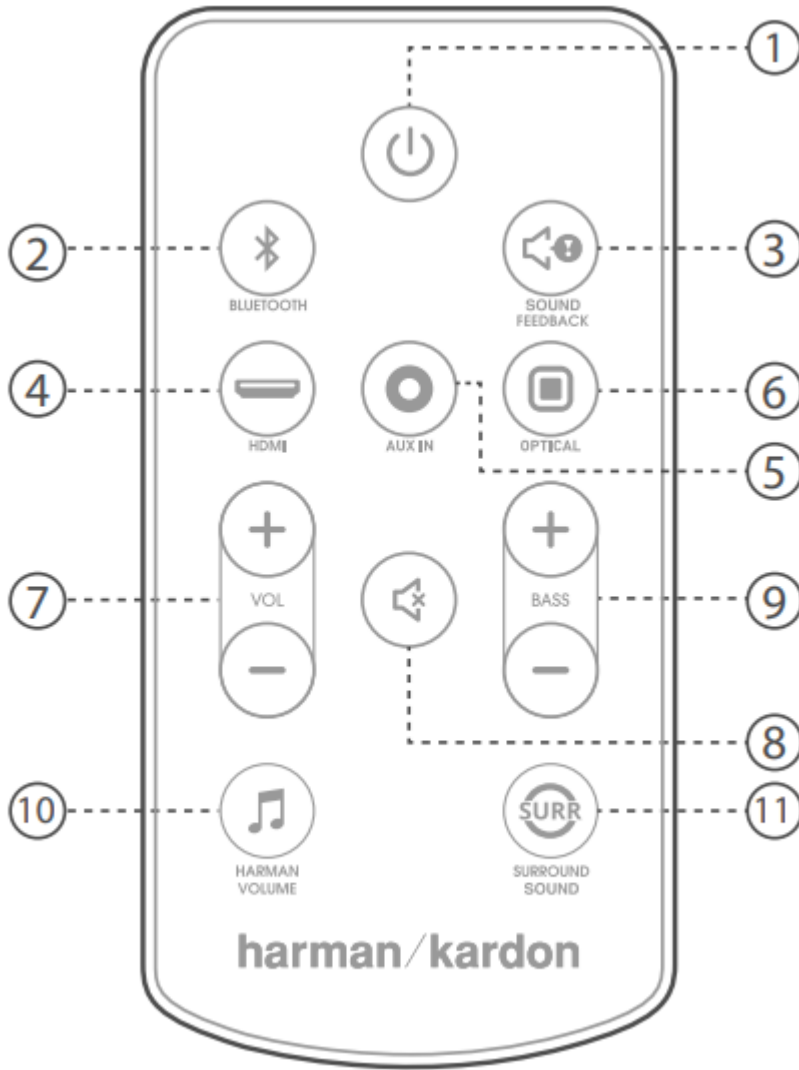

1) Power	6) Optical
2) Bluetooth	7) Vol +/-
3) Sound Feedback	8) Mute
4) HDMI	9) Bass +/-
5) AUX IN	10) Harman Vol
	11) Surround Sound



Soundbar

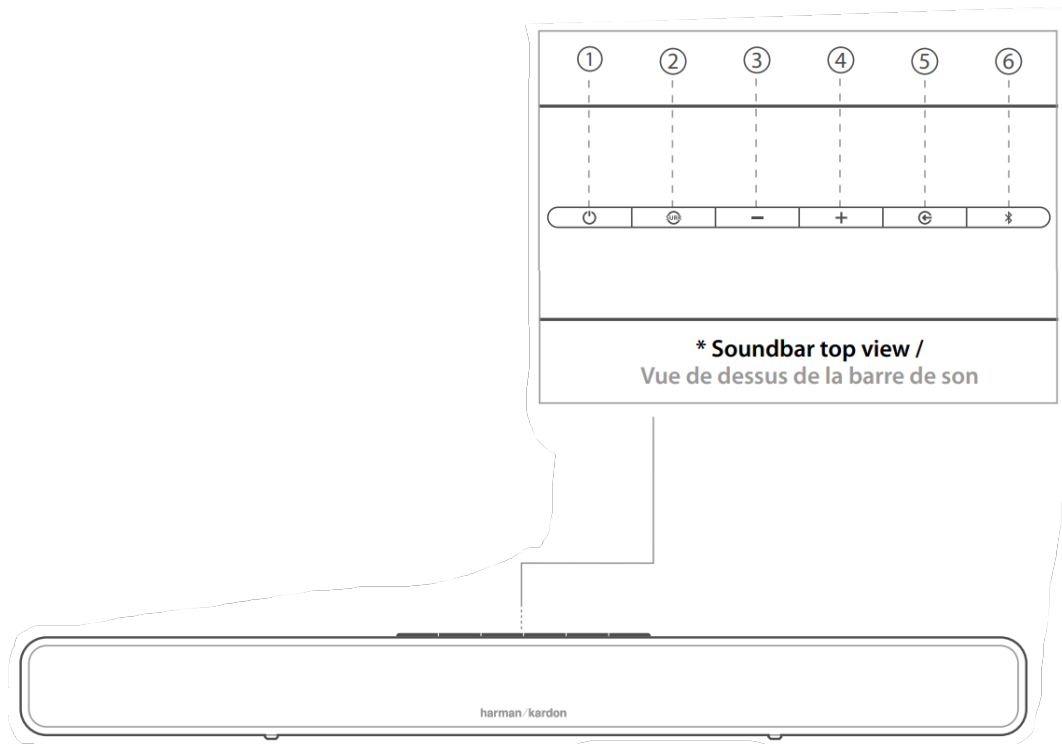

* Soundbar top view

- 1) Power on/Stand by
- 2) Surround mode
- 3) Volume -
- 4) Volume +
- 5) Source selection
- 6) Bluetooth source/Pairing

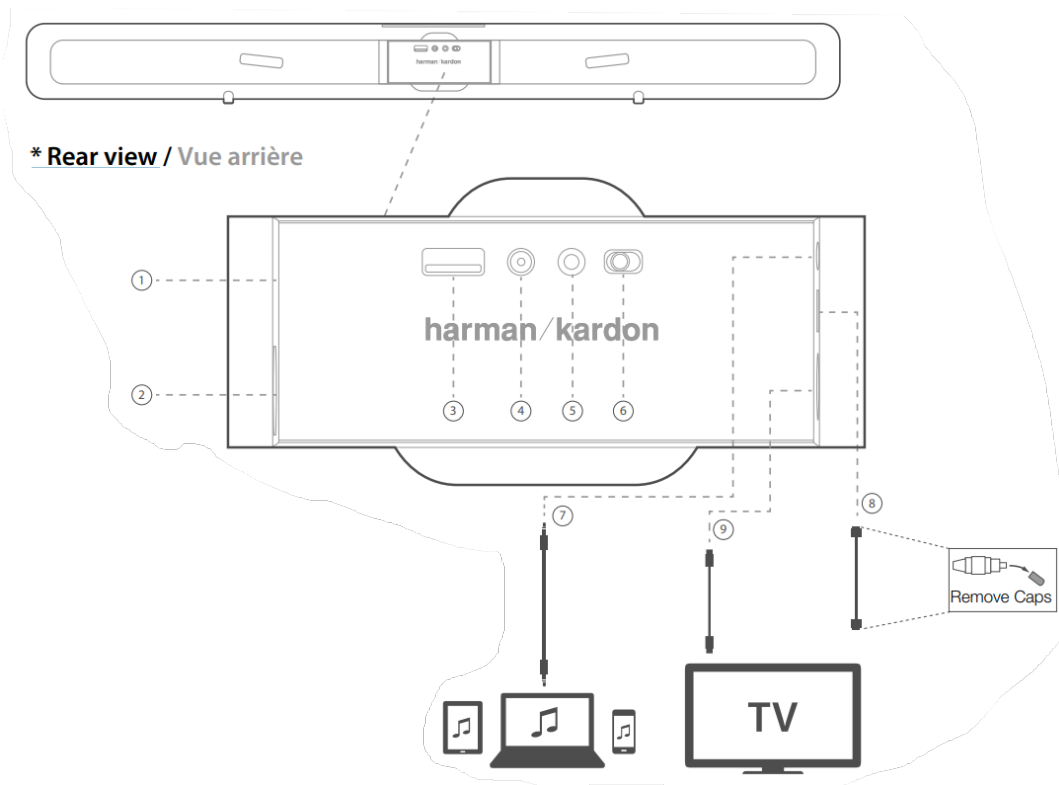

1) Power switch	6) Table/wall equalization (based on your installation)
2) Power input AC	7) Analog Audio in
3) USB (service only)	8) Optical Audio in
4) Wireless subwoofer pairing indicator	9) HDMI TV
5) Wireless subwoofer pairing button	



*** Rear view /
Vue arrière**

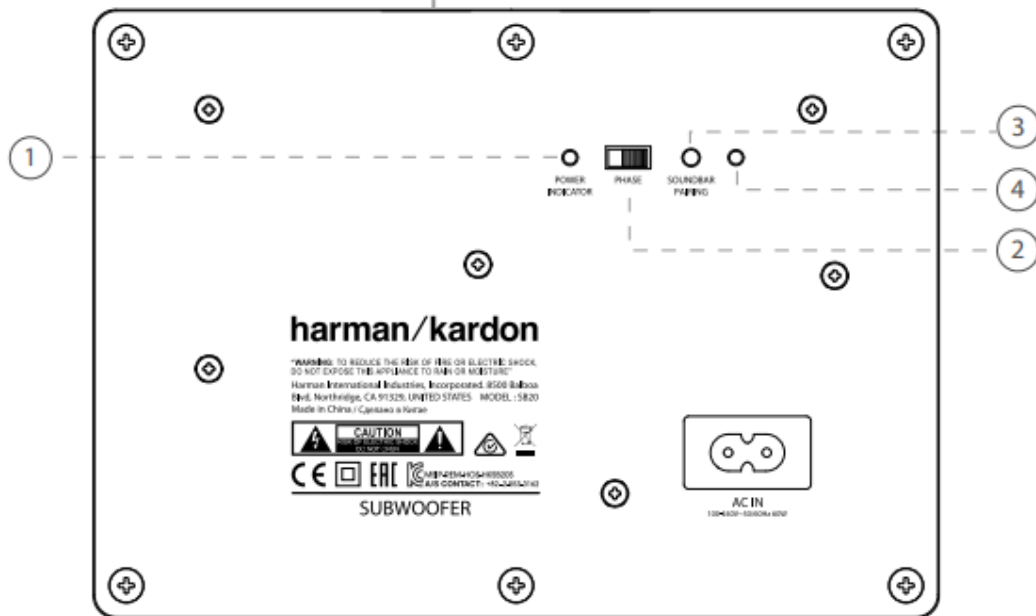
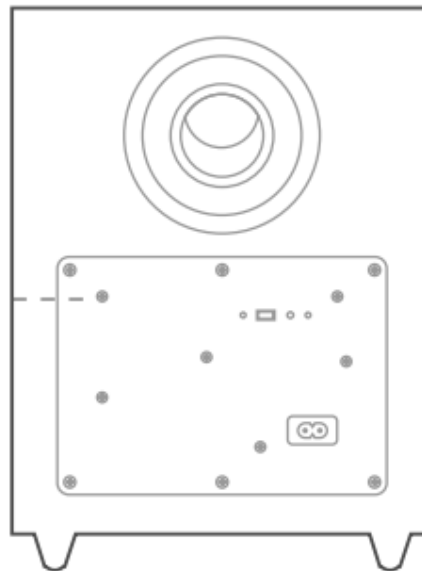



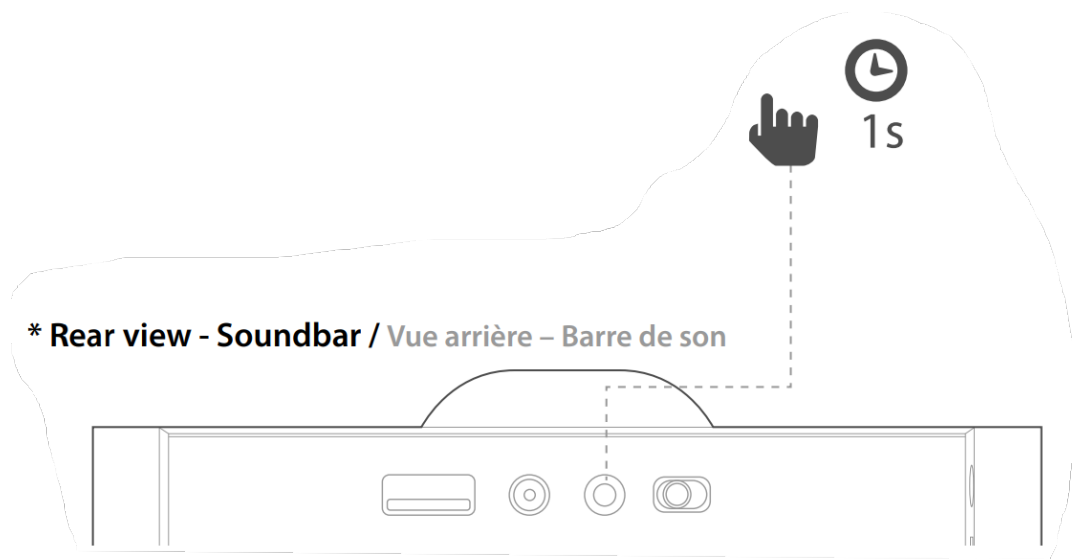

- 1) Power indicator
- 2) Phase adjustment
- 3) Wireless pairing button
- 4) Wireless pairing indicator

SUBWOOFER PARING



Press the pairing button on the back of the soundbar to enter the wireless pairing mode (white flashing LED)

	LED behavior
Pairing mode	 (Quick blinking)
Idle mode	 (Slow blinking)
Connected	
Standby Mode	 (Amber)

Press the pairing button on subwoofer for more than 1 second to pair the subwoofer to the soundbar.

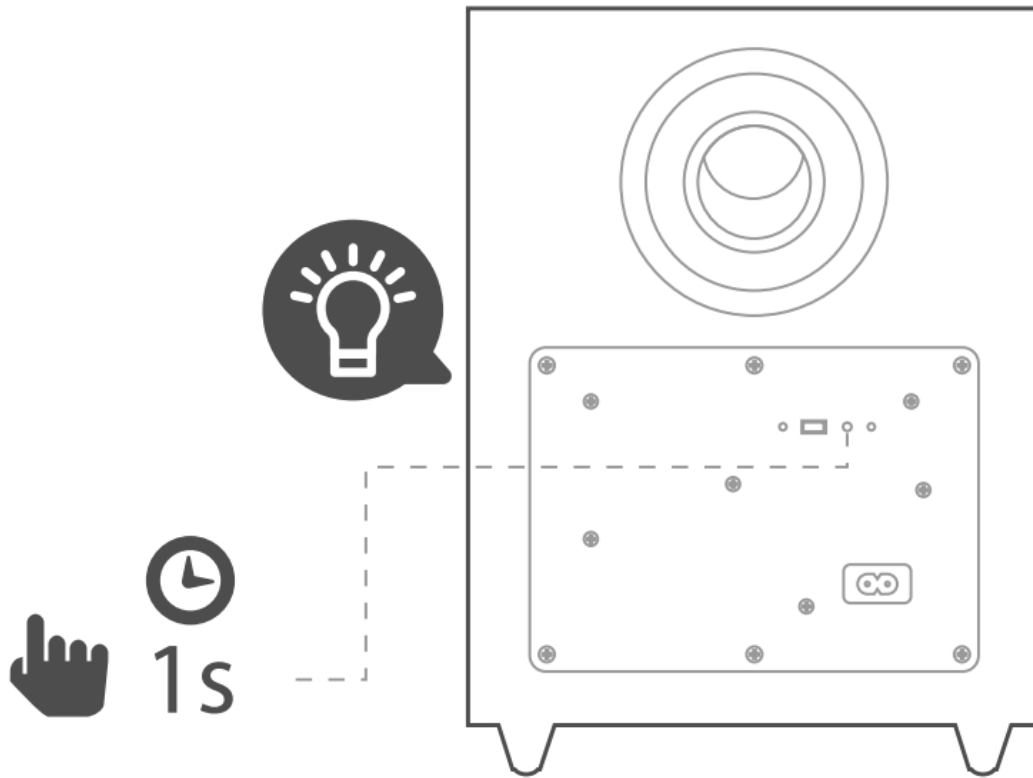

The LED will stop blinking and remain a solid white color when paired

Rear view - Soundbar

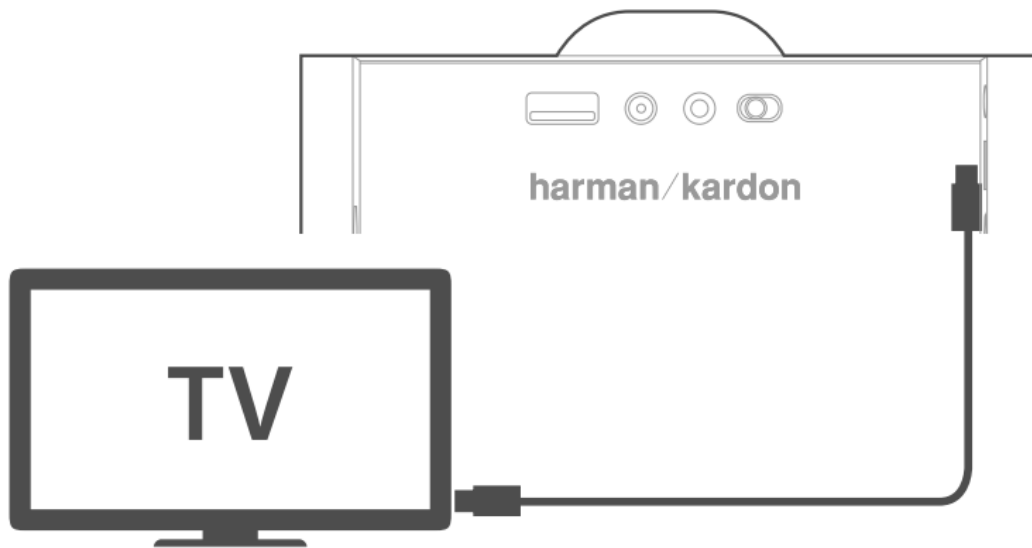

* HDMI(ARC)-equipped TV /



WALL MOUNT OPERATION

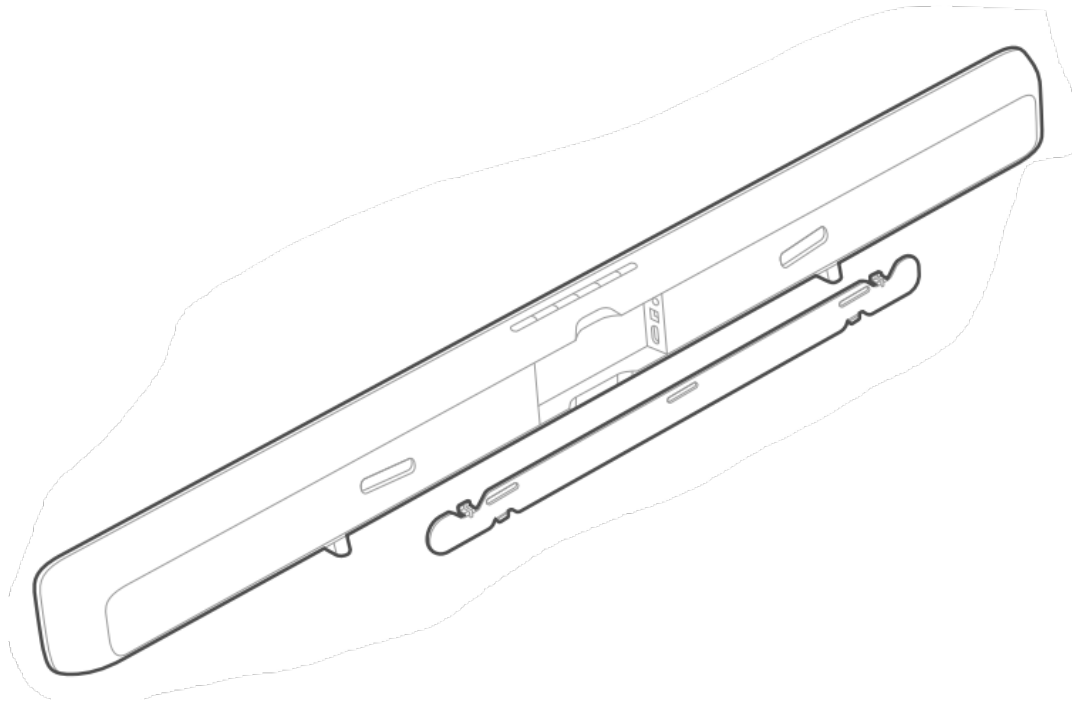

Slide slots in Soundbar t onto tabs on brackets

Rear view - Soundbar

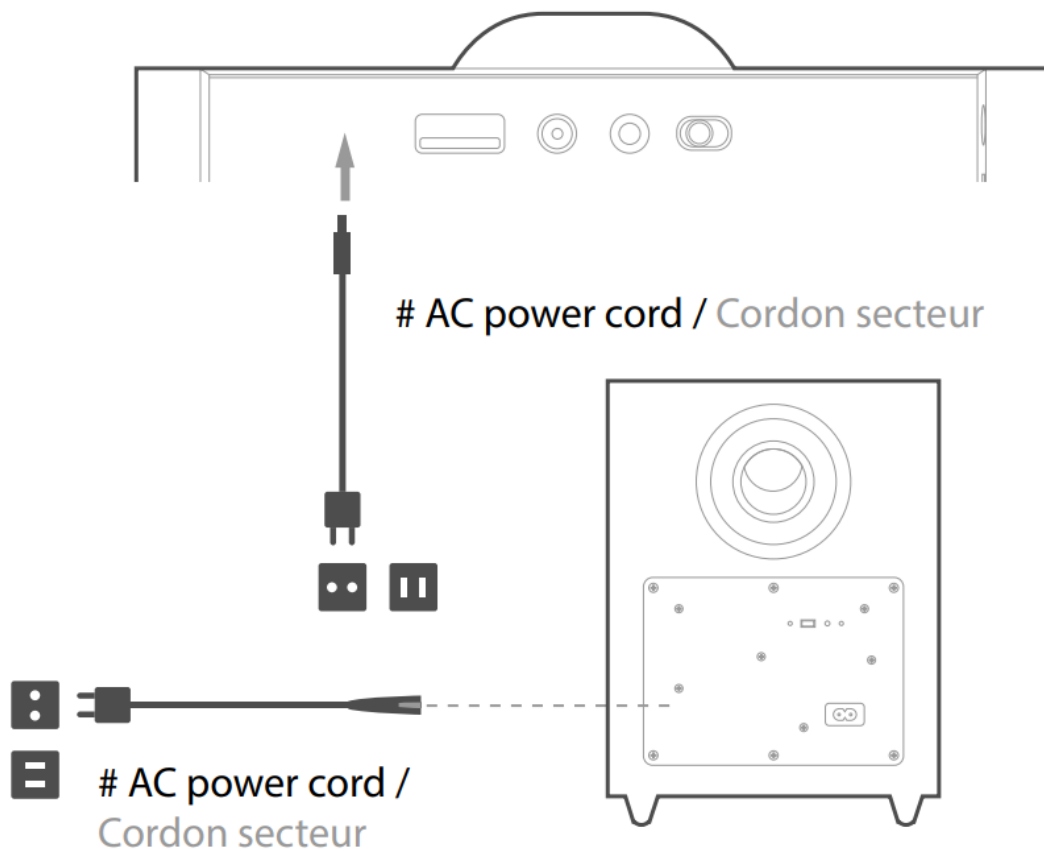

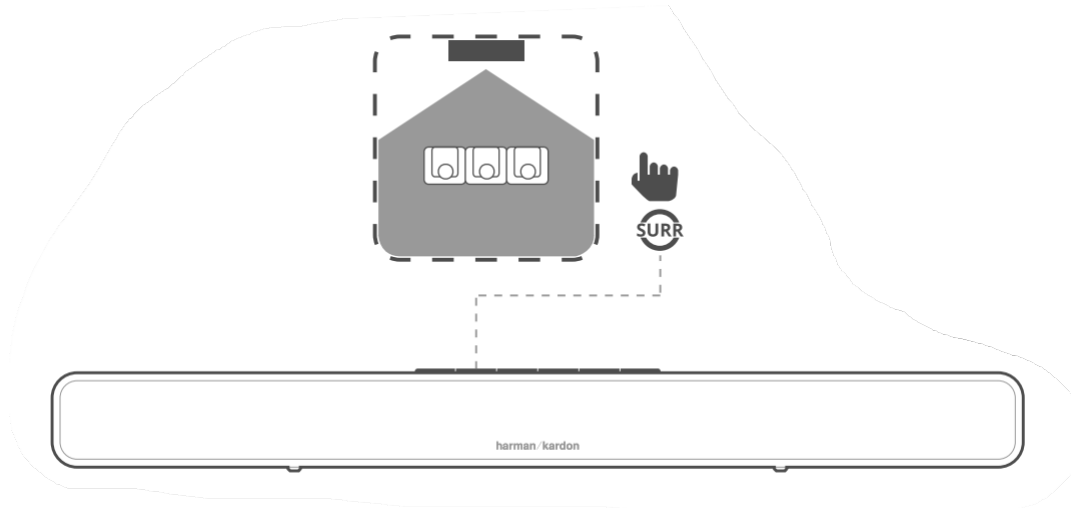

SURROUND SOUND

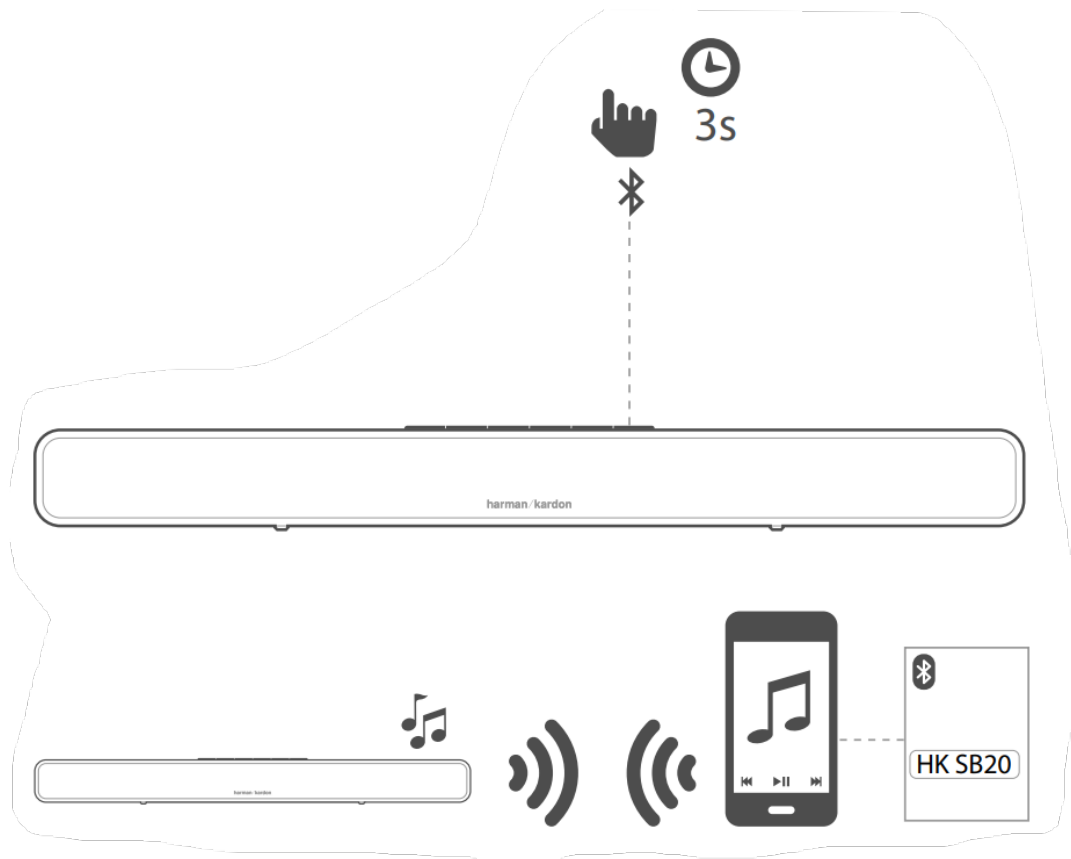

BLUETOOTH CONNECTION



	LED behavior
Connecting	 (Quick blinking)
Connected	
Not connected	 (Slow blinking)

SPECIFICATIONS

- Model Name: Harman Kardon SB 20
- Frequency response: 45Hz - 20kHz
- Maximum SPL: 100dB
- Total SB 20 amplifier power: 300W max
- Subwoofer Low-Frequency Transducer: 165mm (6.5") down-firing cone
- Subwoofer Controls: Phase
- Subwoofer Enclosure Type: Bass reflex
- Speaker Low-Frequency Transducer: 4 x 55mm (2.25")
- Speaker High-Frequency Transducer: 2 x 32mm (1.25")
- Outputs: 1 HDMI port with Audio Return Channel (ARC)
- Inputs: 1 stereo analog-audio, 1 optical digital
- Bluetooth® connectivity
- Dolby® Digital Decoding
- Soundbar Dimensions (L x W x H): 1008 x 54 x 97 mm
- Soundbar Weight: 2.3 kg
- Subwoofer Dimensions (L x W x H): 240 x 240 x 318 mm
- Subwoofer Weight: 5.1 kg

CAUTION: This equipment is a Class II or double insulated electrical appliance. It has been designed in such a way that it does not require a safety connection to electrical earth.

WARNING:



- Do not ingest the battery, Chemical Burn Hazard

- The remote control supplied with) This product contains a coin/button cell battery. If the coin/button cell battery is swallowed, it can cause severe internal burns in just 2 hours and can lead to death.
- Keep new and used batteries away from children.
- If the battery compartment does not close securely, stop using the product and keep it away from children.
- If you think batteries might have been swallowed or placed inside any part of the body, seek immediate medical attention.

CAUTION:

Danger of explosion if battery is incorrectly replaced. Replace only with the same or equivalent type.

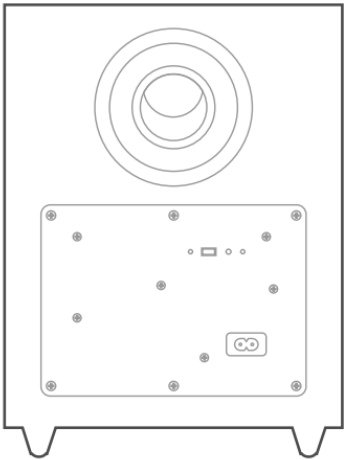
PACKAGE CONTENT

	
<p>Wireless subwoofer</p>	<p>Remote</p>
	
<p>Soundbar</p>	



Wall mount accessories

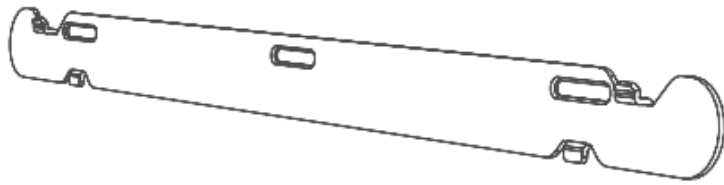

Optical cable



HDMI cable



Soundbar power cable



Subwoofer power cable



Warning

This content is compiled from multiple sources and is provided for reference purposes only. It may not be complete or fully applicable to all situations. If you are unable to resolve your issue, please contact the product manufacturer or an authorized service provider for official support.