

Advantium

What is Advantium?

Getting to know Advantium

The new Advantium oven uses breakthrough Speedcook technology to harness the power of light. The Advantium oven cooks the outside of foods much like conventional radiant heat, while also penetrating the surface so the inside cooks simultaneously. While radiant heat is the primary source of power, a “microwave boost” is added with certain foods. Foods cook evenly and fast, retaining their natural moisture

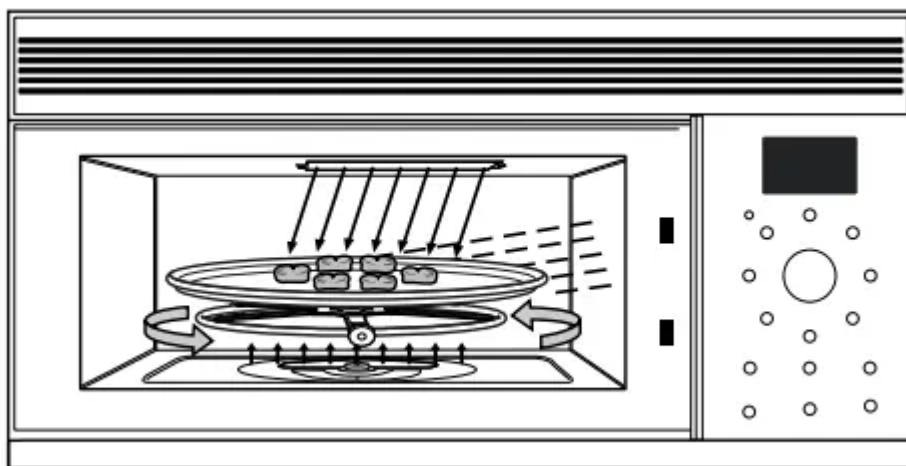

Turntable

- The oven rack (turntable) rotates to ensure even cooking.

Controls

- The oven control contains preset recipes.
- Turn and press dial makes menu selection easy.

Speedcooking

- A 500 watt halogen bulb and a 600 watt ceramic heater cook food from above
- One 375 watt ceramic heater cooks food from below.
- The convection fan ensures even heating.

Oven/Bake and Warming

- One 1100 watt heater cooks food from above.
- One 375 watt ceramic heater cooks food from below
- The convection fan ensures even heating.

Microwave

- A microwave “boost” is automatically added with certain foods.
- The oven can also be used as a 900 watt microwave oven.

Advantium Quick Start

Set the clock

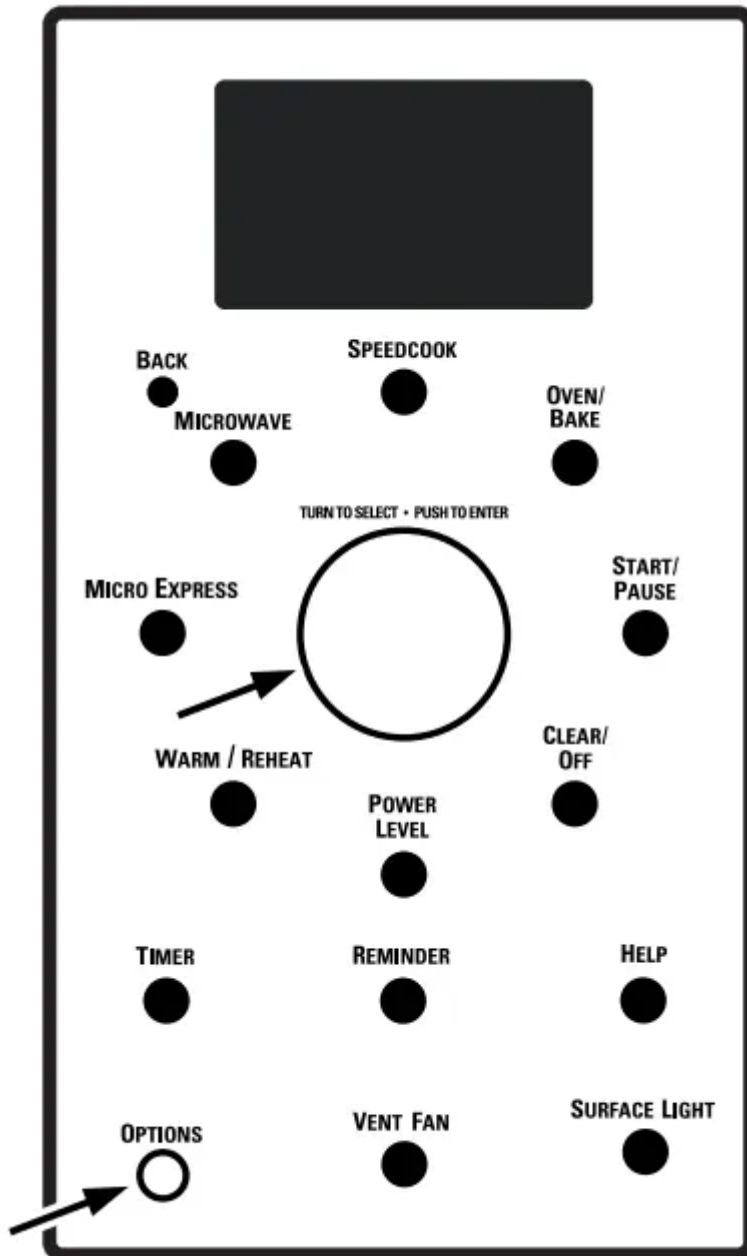

When you first plug in the oven or after a power outage:

1. Turn the selector dial to set the hour. Press the dial to enter.
2. Turn the dial to set the minute. Press the dial to enter.

3. Turn the dial to select AM or PM. Press the dial to enter.

To change the time:

1. Press the OPTIONS button.
2. Turn the dial to CLOCK. Press the dial to enter and follow the display directions to set

Begin speedcooking

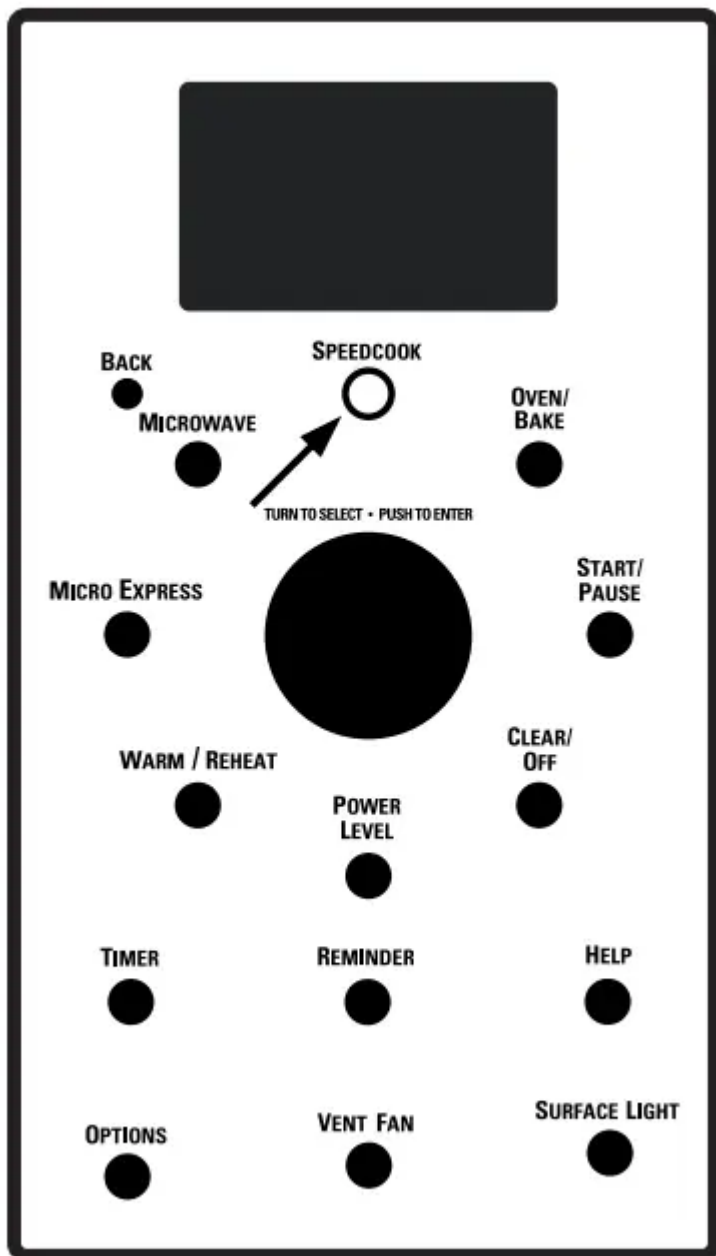

Step 1: Press the SPEEDCOOK button.

Step 2: Turn the dial until the display shows FOOD MENU. Press the dial to enter.

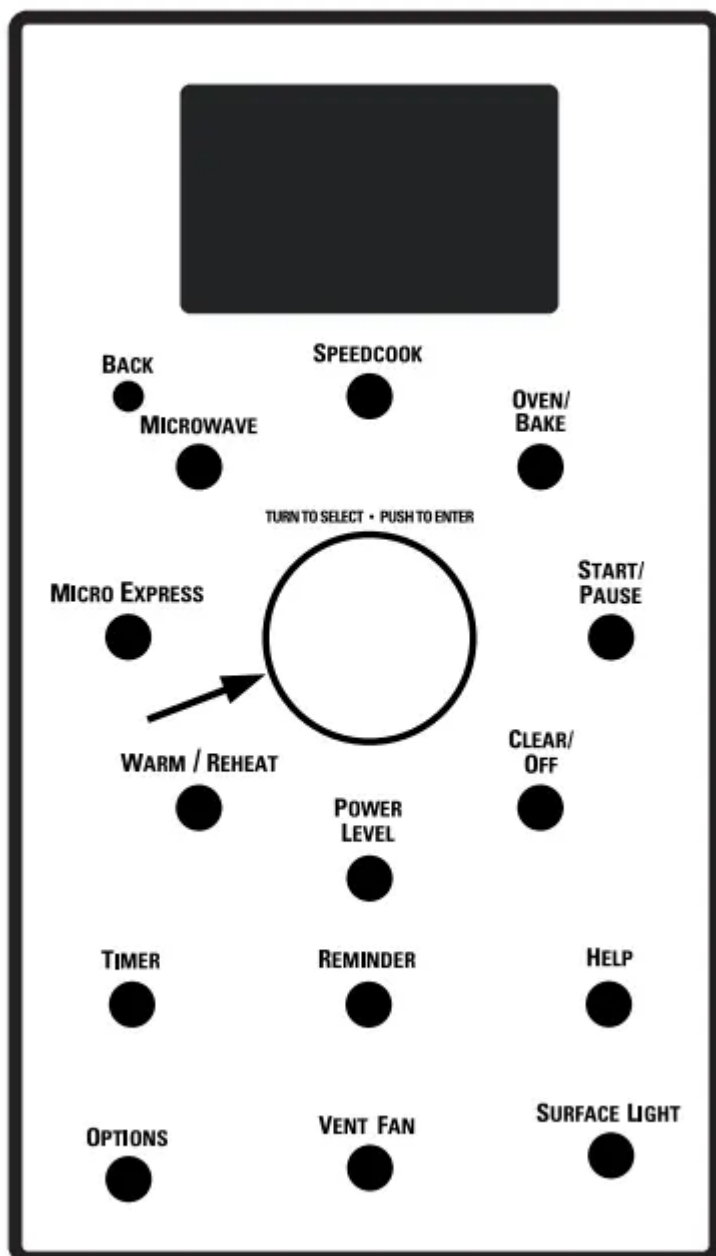

Step 3: Turn the dial to select the type of food you want. Press the dial to enter it.

Step 4: Turn the dial to select the specific food. Press the dial to enter it.

Step 5: Turn the dial to select the amount, size, and/or doneness (if required, the oven will prompt you). Press the dial after each selection.

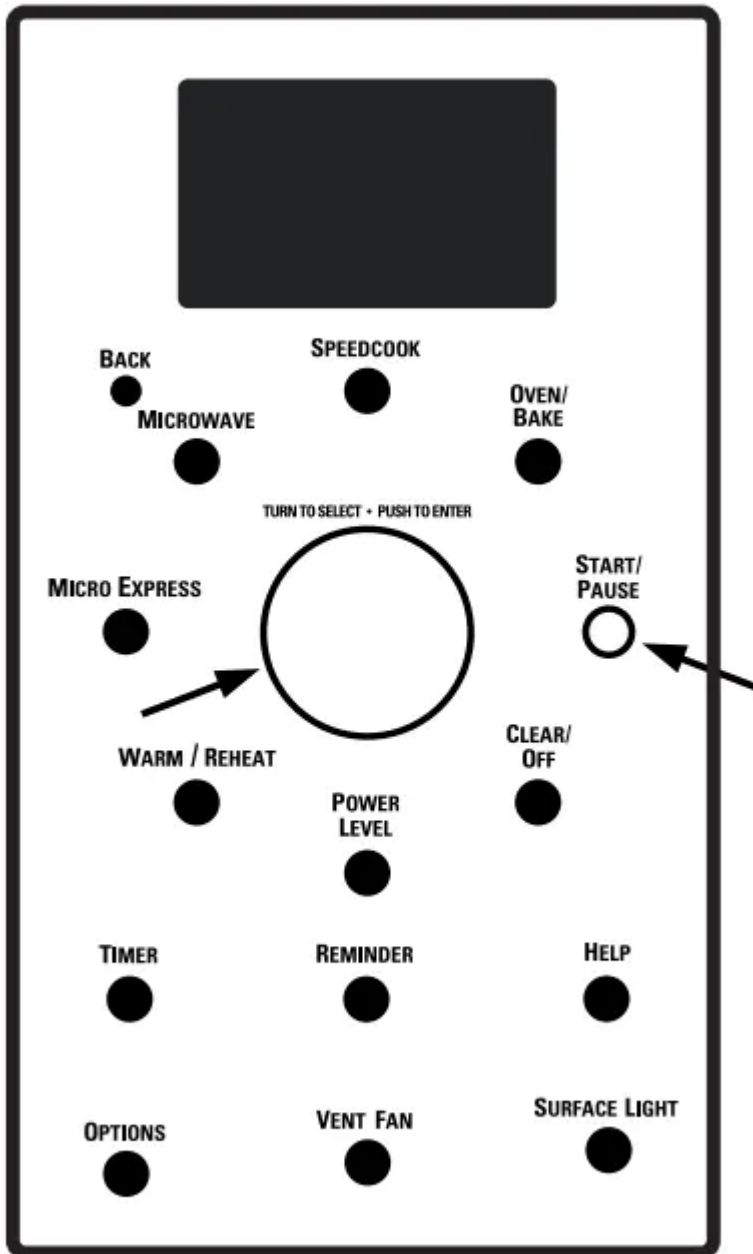

Step 6: After the last selection is made, the time and power levels will be displayed. This is followed a short time later by a cookware message and START?.

Step 7: Once the display shows START?, place the food in the oven and press the dial or start button to start cooking. Speedcooking does not require preheating

- Press CLEAR/OFF at any time to stop cooking.

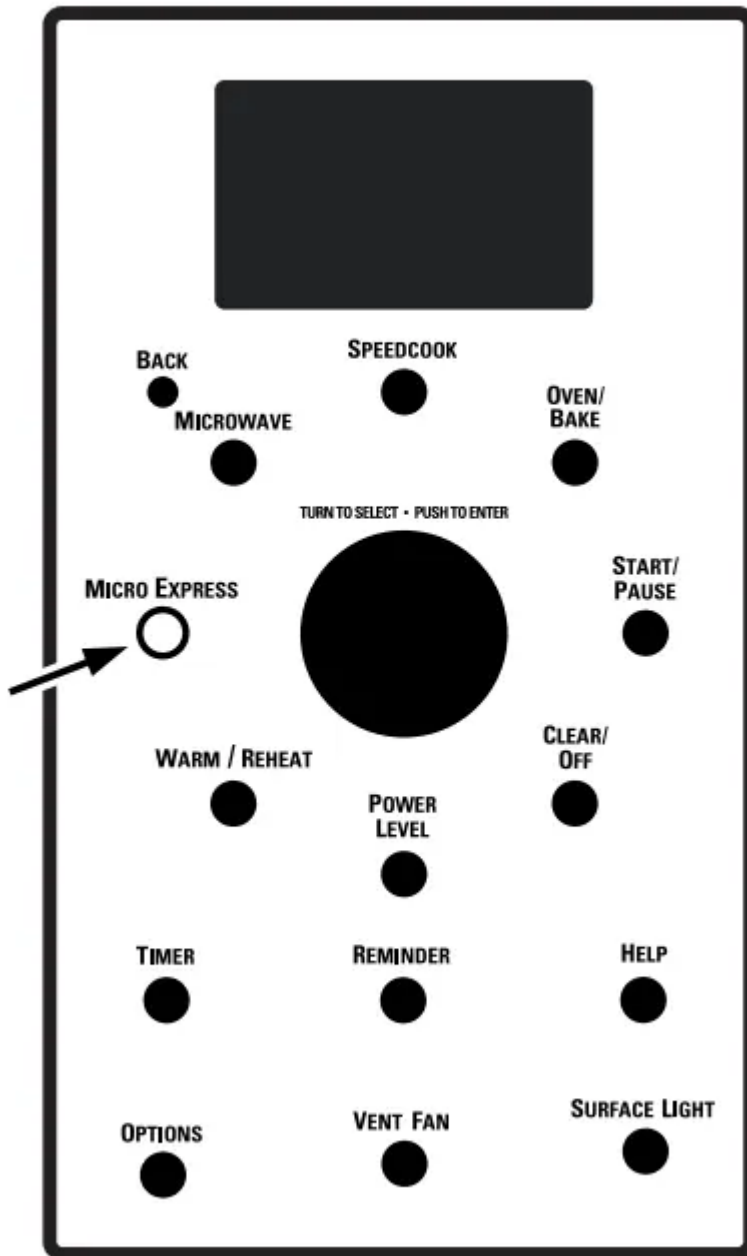

The oven rack (turntable) must always be in place when using the oven.



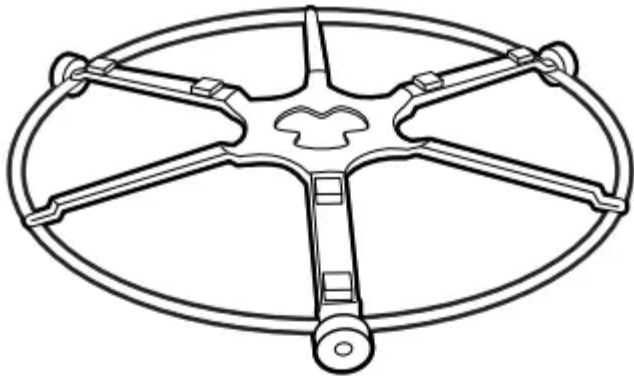

*The oven rack (turntable)
must always be in place
when using the oven.*

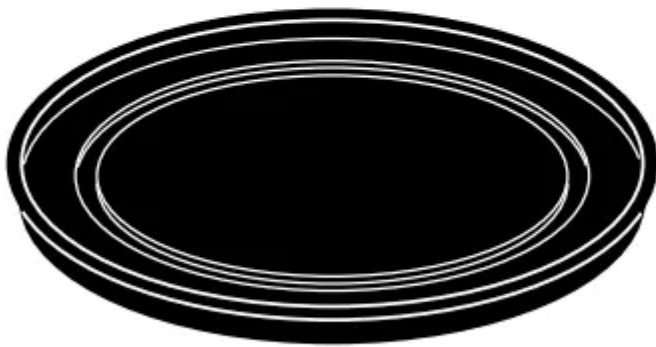

*Put food or non-metal,
oven-safe cookware directly
on the **black metal tray**
to speedcook.*

Put food or non-metal, oven-safe cookware directly on the black metal tray to speedcook.

Microwaving with Micro Express

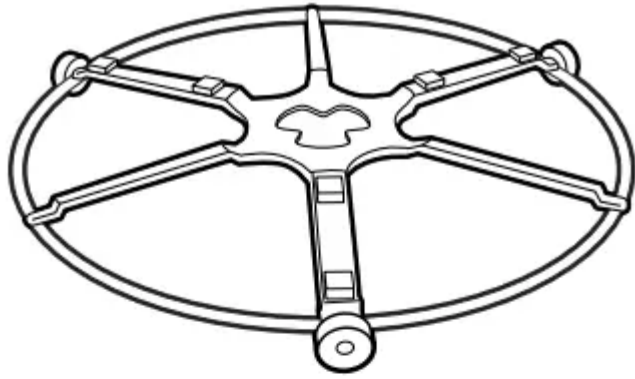

The oven rack (turntable, must always be in place when using the oven.

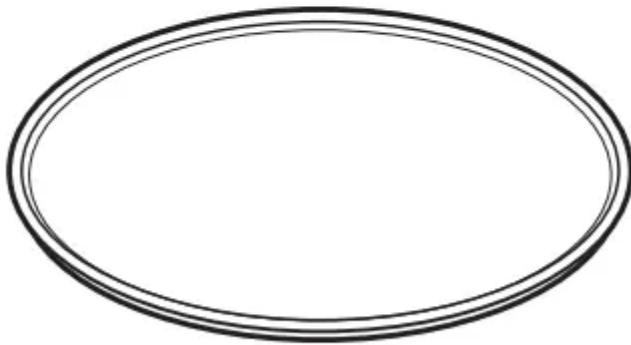

The glass microwave tray should always be in place when microwaving.

Press MICRO EXPRESS for 30 second increments of microwave cooking time.

The oven starts immediately. You may add or subtract time by turning the dial. You may also add time in 30 second increments by pressing MICRO EXPRESS.

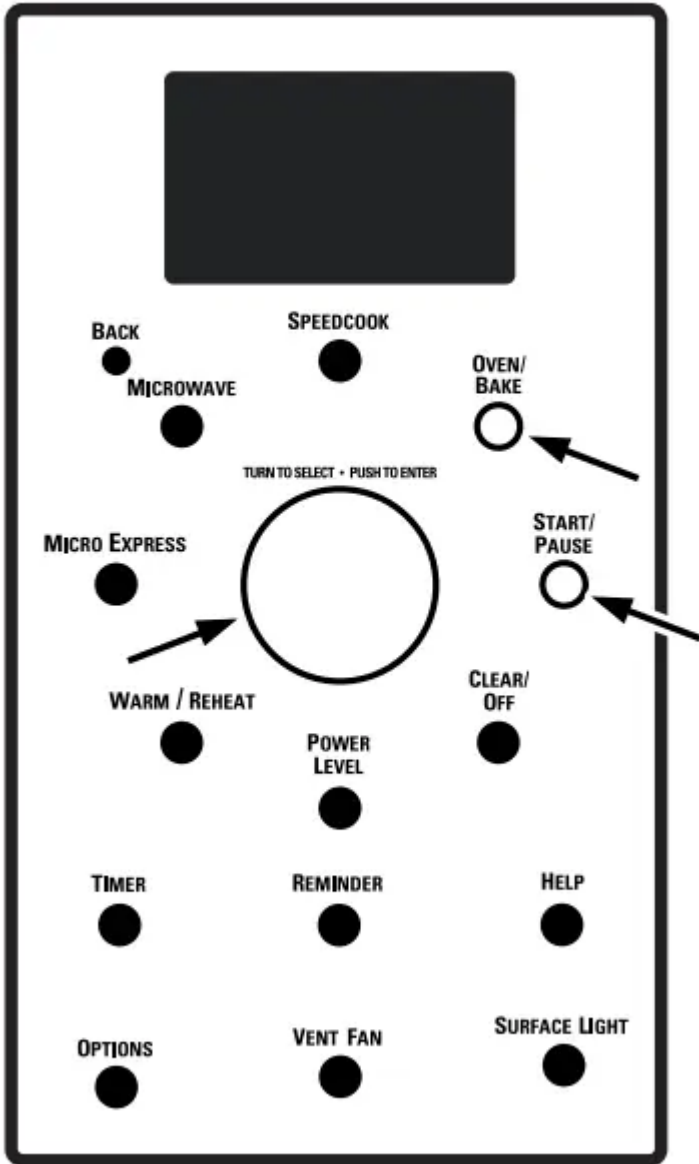

The oven rack (turntable) must always be in place when using the oven.



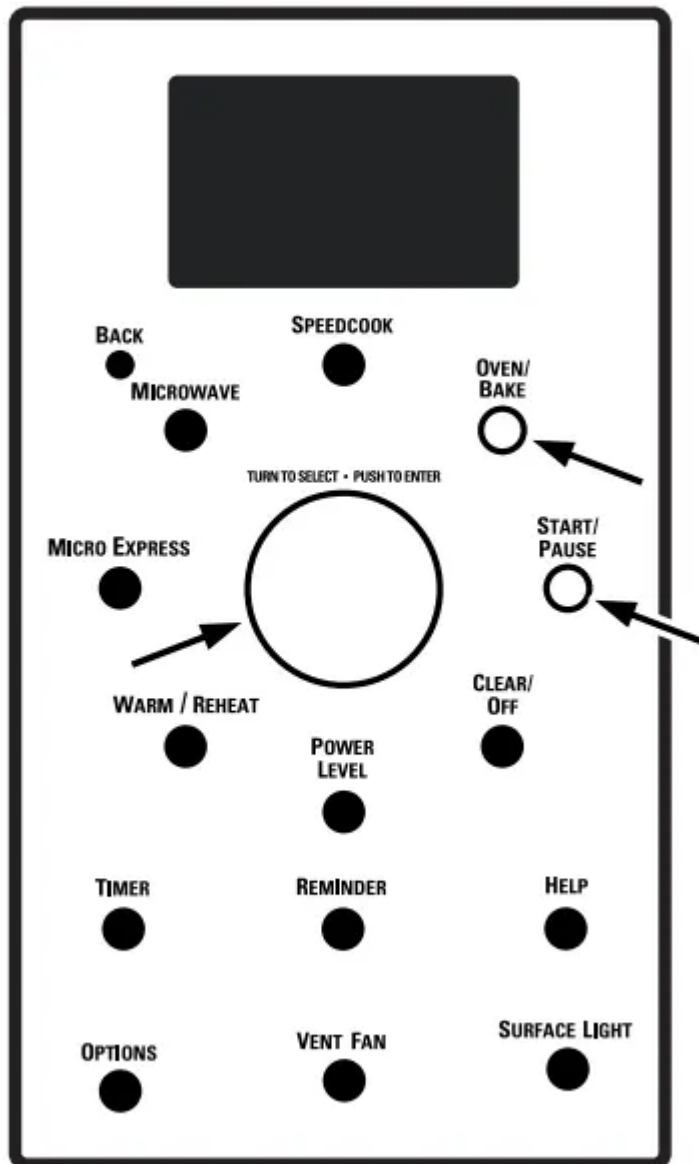

The glass microwave tray should always be in place when microwaving.
Using the Oven/Bake feature



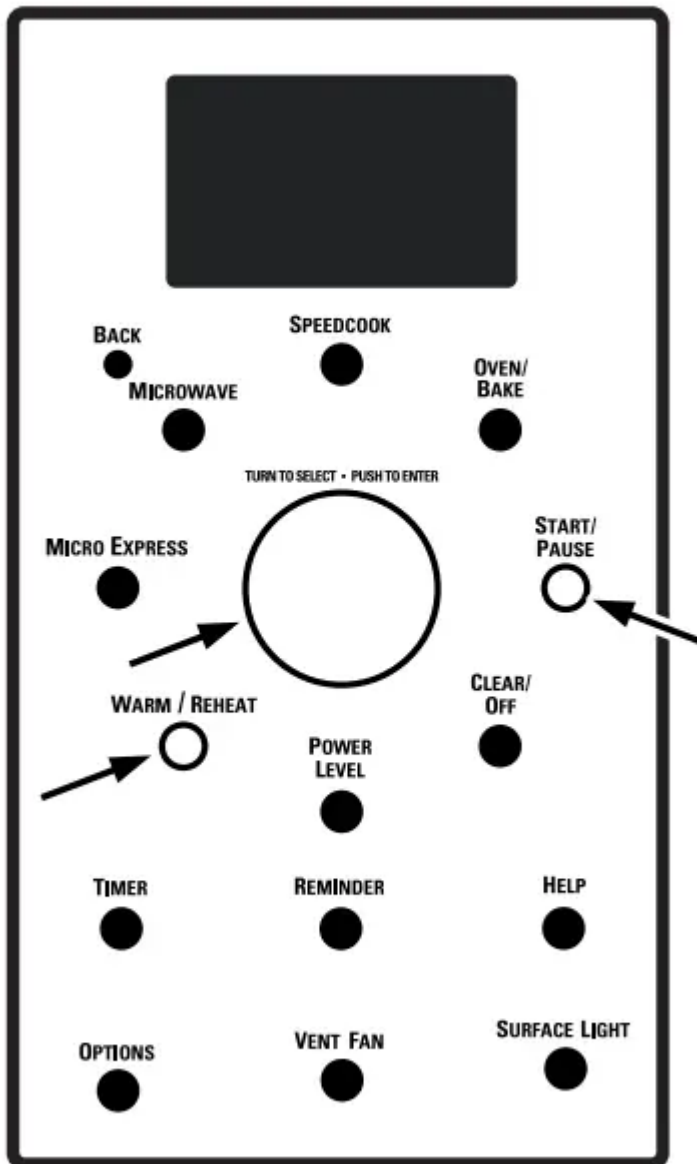

With Preheating

Step 1: Press the OVEN/BAKE button.

Step 2: Turn the dial to set the oven temperature and press dial to start preheating. Do not place the food in the oven.(You will be prompted to enter the cook time after the oven is preheated.)

Step 3: Press the START/PAUSE button to start preheating.

Step 4: When the oven is finished preheating, it will signal. If you do not open the door within 1 hour, the oven will turn off automatically. Open the oven door and, using caution, place the food in the oven.

Step 5: Close the oven door. Turn the dial to set the cook time and press START/PAUSE to start cooking. When cooking is complete, the oven will signal and turn off

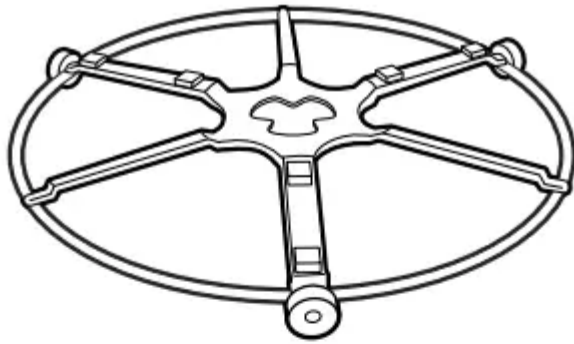

*The oven rack (turntable)
must always be in place
when using the oven.*

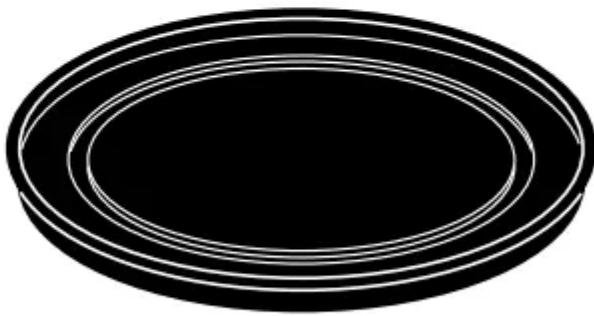

*Put food or oven-safe
cookware directly on the
black metal tray to bake.*

Cook times are shown in minutes and can be a maximum of 179 minutes. Time can be changed during cooking by turning the dial.

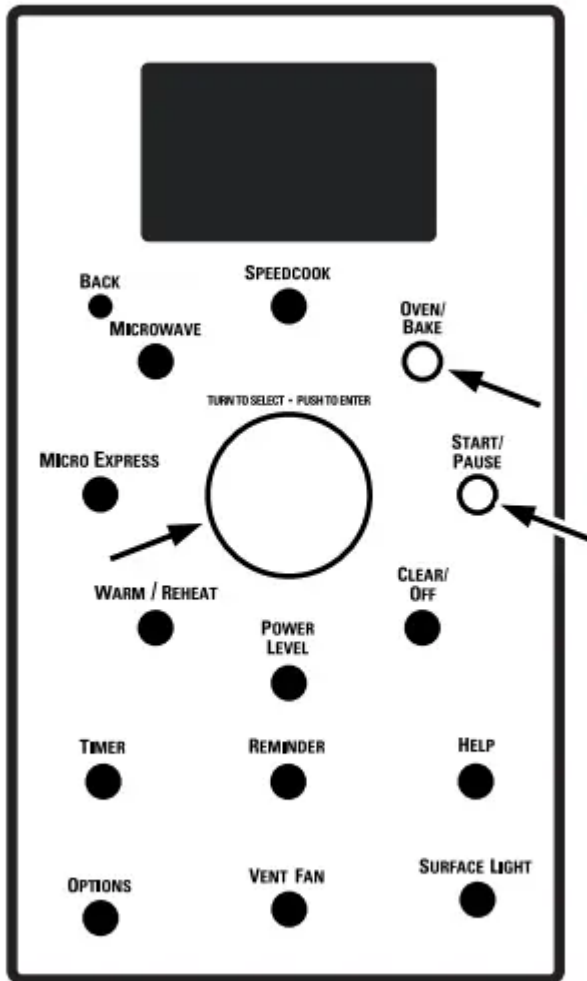

Without Preheating

Step 1: If your recipe does not require preheating, press the OVEN/BAKE button.

Step 2: Turn the dial to set the oven temperature and press to enter.

Step 3: To bypass preheating, press the dial again.

Step 4: Turn the dial to set the cook time and press to enter.

Step 5: Place the food in the oven, and press the START/PAUSE button to start the oven.

Cook times are shown in minutes and can be a maximum of 179 minutes. Time can be changed during cooking by turning the dial.

Using the Warming feature

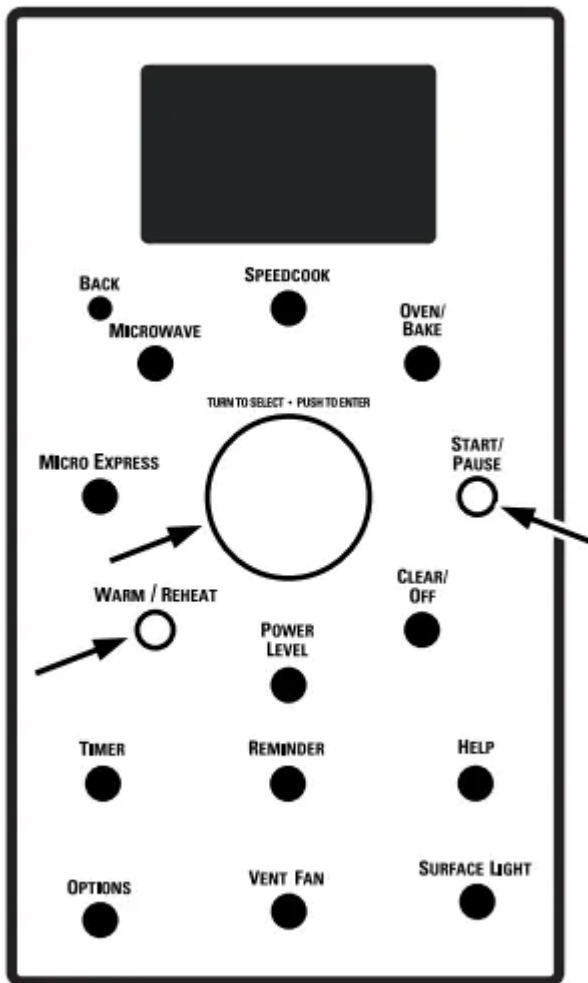

Step 1: Press the WARM/REHEAT button.

Step 2: Turn the dial to select WARMING. Press the dial to enter

Step 3: Turn the dial to select the oven temperature.

LOW.....140–160°F

MEDIUM160–195°F

HIGH195–230°F

Step 4: Turn the dial to select the level of moisture you want. Press the dial to enter.

Display prompts

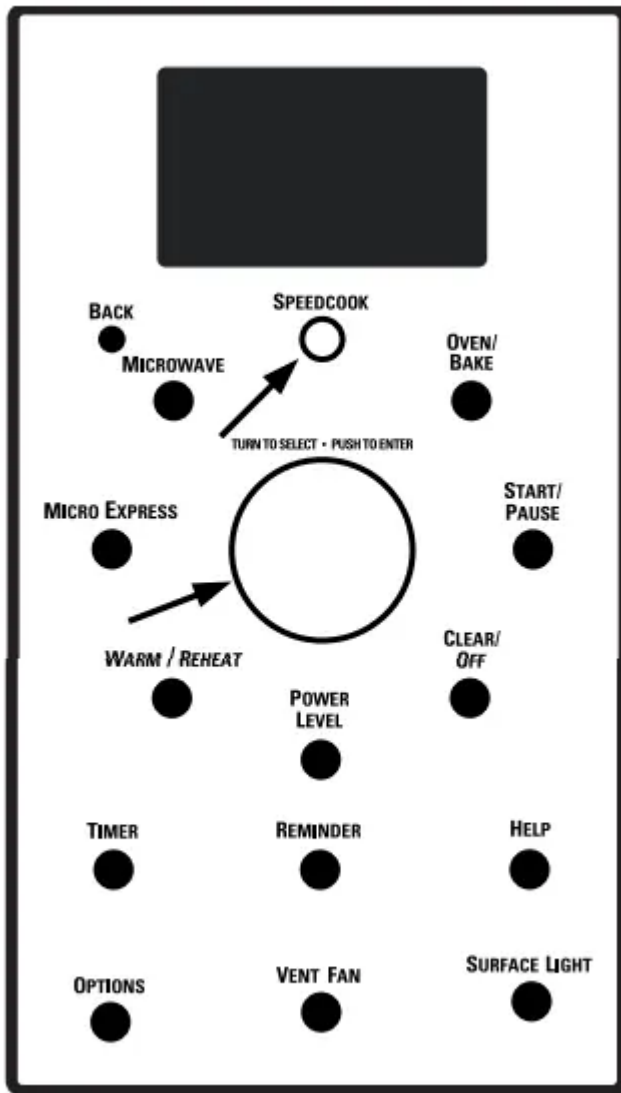

After pressing the SPEEDCOOK button, the oven will prompt you to make several selections, such as in the example below

1. Turn the dial until FOOD MENU appears. Press the dial to enter.
2. Turn the dial until CHICKEN appears. Press the dial to enter.

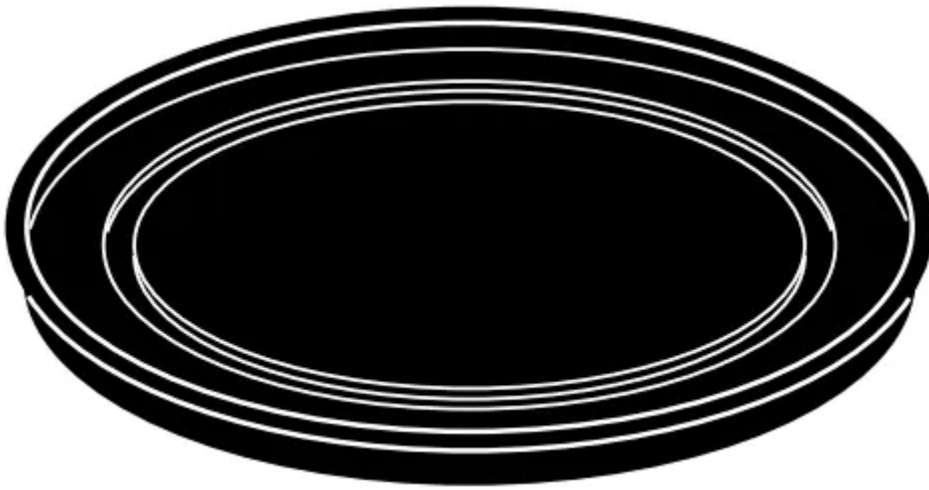

NOTE: When speedcooking, always use the black tray.

3. Turn the dial until

BONELESS BRST (boneless breast) appears. Press the dial to enter.

4. Turn the dial to Select SIZE:

Sm (3–4 oz)

Lg (5+ oz)

Press the dial to enter.

5. Turn the dial to

Select amount:

1–2 pieces

3–4 pieces

Press the dial to enter.

6. Use METAL TRAY is displayed.

Pre-set speedcook menu selections

After a cooking cycle has been completed, use the Resume feature to cook for additional time

To review settings during cooking, press the selector dial.

See the Cooking Guide packed with the oven for a complete list of pre-set speedcook menu selections.

Oven Features

Throughout this manual, features and appearance may vary from your model.

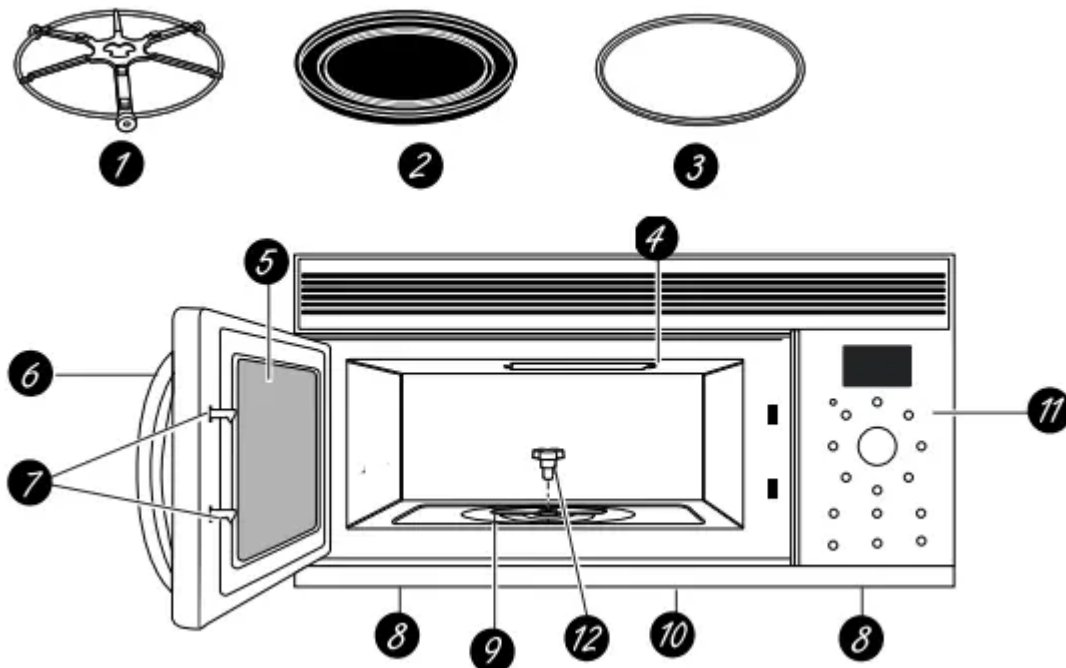

1. Oven Rack (Turntable)

The oven rack (turntable) must always be in place, on the oven floor, for all cooking. Be sure the oven rack (turntable) is seated securely over the hub in the center of the oven.

2. Black Metal Tray/Baking

Sheet Put food or appropriate cookware directly on the black metal tray and place on the oven rack(turntable) when using the speedcook, oven/bake or warming features.

3. Glass Microwave Tray

Center the tray on the oven rack (turntable) when using the microwave features. The tray will not lock onto the center hub. Place food or microwave-safe cookware directly on the tray.

4. Upper Heaters

Operate when using the speedcook, oven/bake or warming features.

5. Window

Allows food to be viewed while keeping microwaves confined in the oven.

6. Door Handle

Pull to open the door. The door must be securely latched for the oven to operate.

7. Door Latches

8. Vent Fan

Press the VENT FAN button to remove steam and other vapors from surface cooking.

9. Lower Ceramic Heater

Operates when using the speedcook, oven/bake or warming features.

10. Cooktop Light

Press the SURFACE LIGHT button to turn the cooktop light on and off.

11. Control Panel

The buttons used to operate the oven are located on the control panel.

12. Hub

The hub turns the oven rack. Make sure the hub is always firmly in place in the bottom of the oven.

Cooking controls

With your Advantium oven, you can cook with high-intensity halogen lights, ceramic heaters and/or conventional microwave energy.

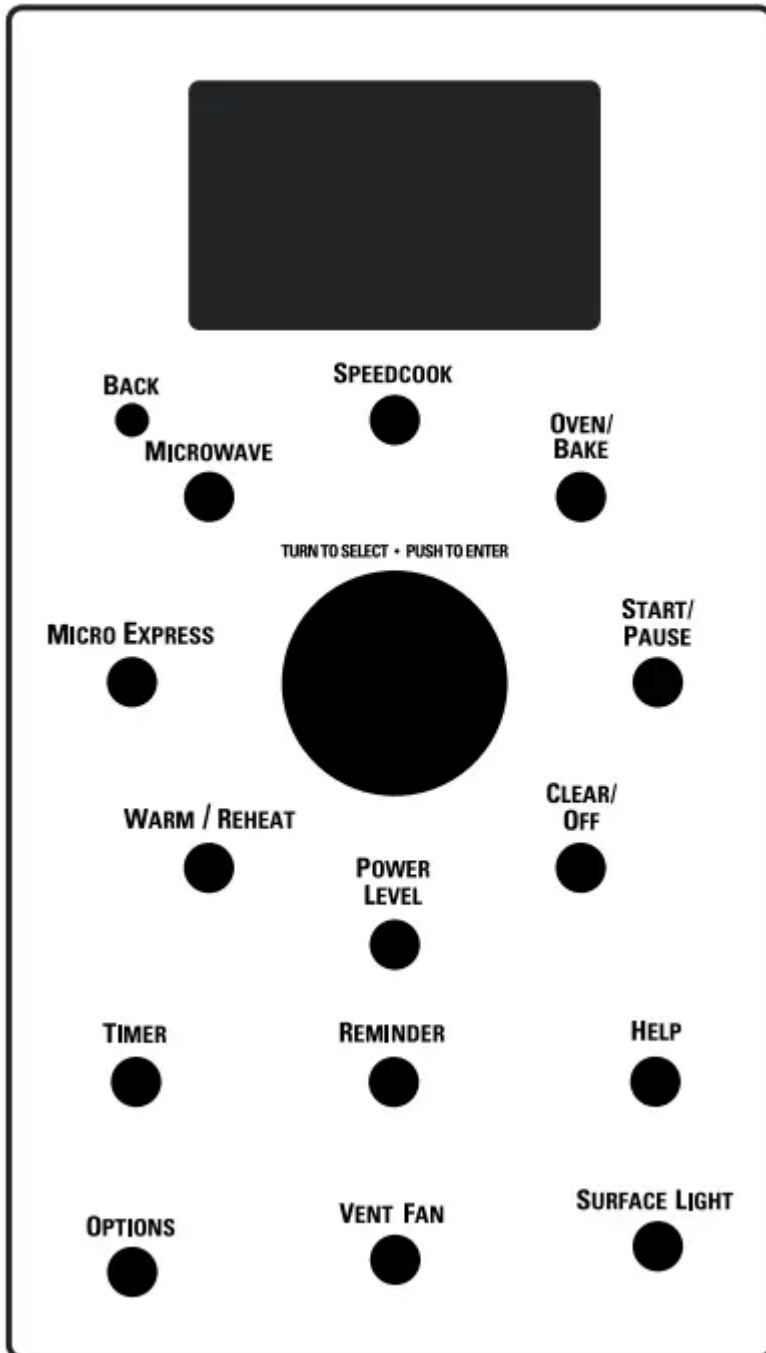

SPEEDCOOK

Press this button to access the speedcook menu or to set your own speedcook program. Press and hold for 3 seconds to repeat the last cooking selection.

SELECTOR DIAL–Turn to select, Push to enter First turn then press the dial to make selections. Also use the dial to increase (turn clockwise) or decrease (turn counterclockwise) cooking times or temperatures. **START/PAUSE** Press this button to start or pause any cooking function.

CLEAR/OFF

Press this button to cancel ALL oven programs except the clock, auto night light, timer and reminder.

POWER LEVEL

Press this button and turn/press the selector dial to change the speedcook or microwave power levels, or the oven/bake temperature before and during cooking.

TIMER

Press this button to set the minute timer.

MICROWAVE

Press this button to access the microwave menu or to set your own microwave program.

MICRO EXPRESS

Press for 30 seconds of microwave cooking time. Each time the button is pressed adds an additional 30 seconds to the remaining cooking time. The oven starts immediately.

BACK

On certain features, press this button to return to the previous step.

OVEN/BAKE

Press this button to bake foods using conventional oven cooking.

WARM/REHEAT

Press this button to operate the warming and reheating features. Keep hot, cooked foods at serving temperature, or reheat servings of previously cooked foods

VENT FAN

Press this button to remove steam and other vapors from surface cooking.

REMINDER

Can be used like an alarm clock and can be used at any time, even when the oven is operating. It can be set to beep at a certain time, up to 24 hours later.

OPTIONS

Press this button to set the Clock and access the Beeper Volume, Clock Display ON/OFF, Display Scroll Speed, Delayed Start and Night Light features.

HELP

Press this button to find out more about your oven's features.

SURFACE LIGHT

Press this button to turn the cooktop light on and off.

Speedcooking

Using speedcook features

CAUTION: When using speedcook programs, remember that the oven, door and dishes will be very hot!

Prior to the first use of your oven, the clock must be set. See the Advantium Quick Start section.

Before you begin, make sure the oven rack (turntable) is in place. Use the black metal tray (baking sheet), at all times when speedcooking

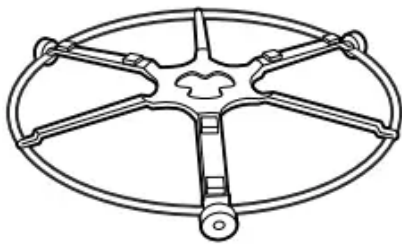

*The **oven rack (turntable)** must always be in place when using the oven.*

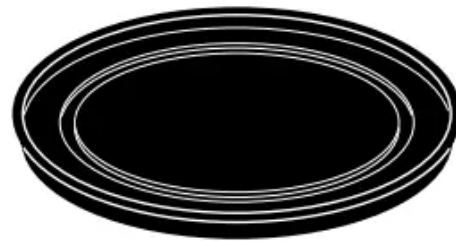

*Put food or non-metal, oven-safe cookware directly on the **black metal tray** to speedcook.*

To use a pre-set speedcook menu

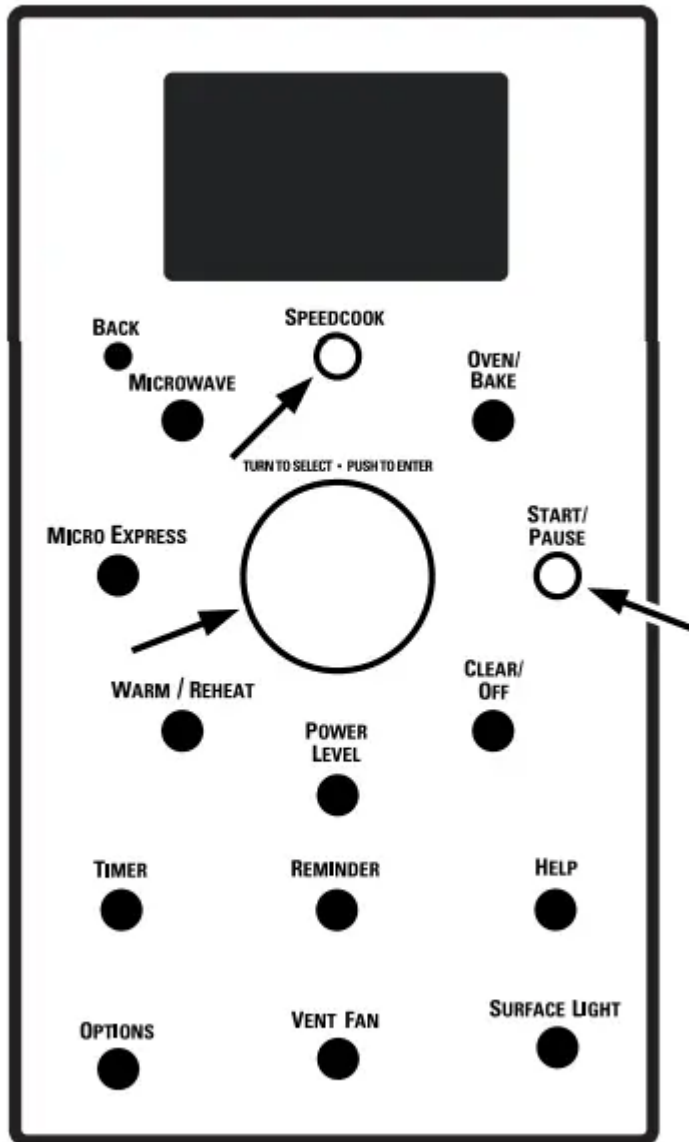

Advantium is already pre-set to cook over 100 popular dishes.

1. Press the speedcook button. If no selection is made within 15 seconds, the display will revert back to the time of day.
2. Turn the selector dial to FOOD MENU. Press the dial to enter.
3. Turn the selector dial to select the type of food category you want. Press the dial to enter.
4. Turn the selector dial to select the specific food (menu selection). Press the dial to enter.
5. Turn the selector dial to select amount, size and/or doneness (if required, the oven will prompt you.) Press the dial after each selection
6. Once the display shows: START? either press start or the selector dial to start cooking.

For certain foods, turn the food over when the oven signals TURN FOOD OVER. Press START to resume cooking.

For certain foods, the oven will signal CHECK for DONENESS,. Check to see if the food is done to your liking. The oven will continue to cook for several minutes. Take the food out when it is done to your liking.

To review settings during cooking, press the selector dial.

If you enter an undesired selection at any time, simply press the BACK button to return to the previous step, or press the CLEAR/OFF button and re-enter the desired selections.

- Early in a speedcook program, you will see OPTIMIZING COOK TIME in the display. The oven automatically senses the electrical voltage level in your home and adjusts the cooking time up or down for proper cooking.
- If the door is opened during cooking, the oven will stop and PAUSE will appear in the display. Close the door and press the START/PAUSE button to resume cooking
- At anytime during cooking you can turn the selector dial to change the cooking time. You can change power levels by pressing POWER LEVEL.
- To assure consistent cooking results, the oven may reduce power levels if the oven is hot at the beginning of a program.
- At the end of cooking, the automatic fan may continue to run for a short time to cool internal components.
- To cook for additional time after a cooking cycle has been completed, use the resume feature

Cooking tips for great tasting results

To ensure consistent and even browning when cooking foods directly on the black metal tray, arrange food as shown below.

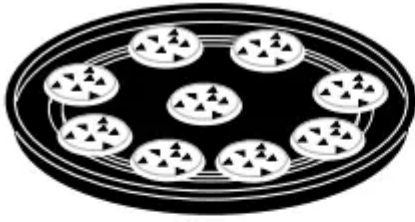

Circular pattern
(Example: biscuits, cookies, meats)



Spoke pattern
(Example: crescent rolls, breadsticks)

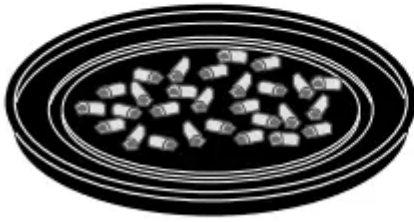

Single layer
(Example: appetizers)

Fresh meat, chicken, fish or seafood that has been frozen should be thawed before cooking (the microwave defrost feature can be used). For other frozen prepackaged foods, follow package directions.

Repeat last

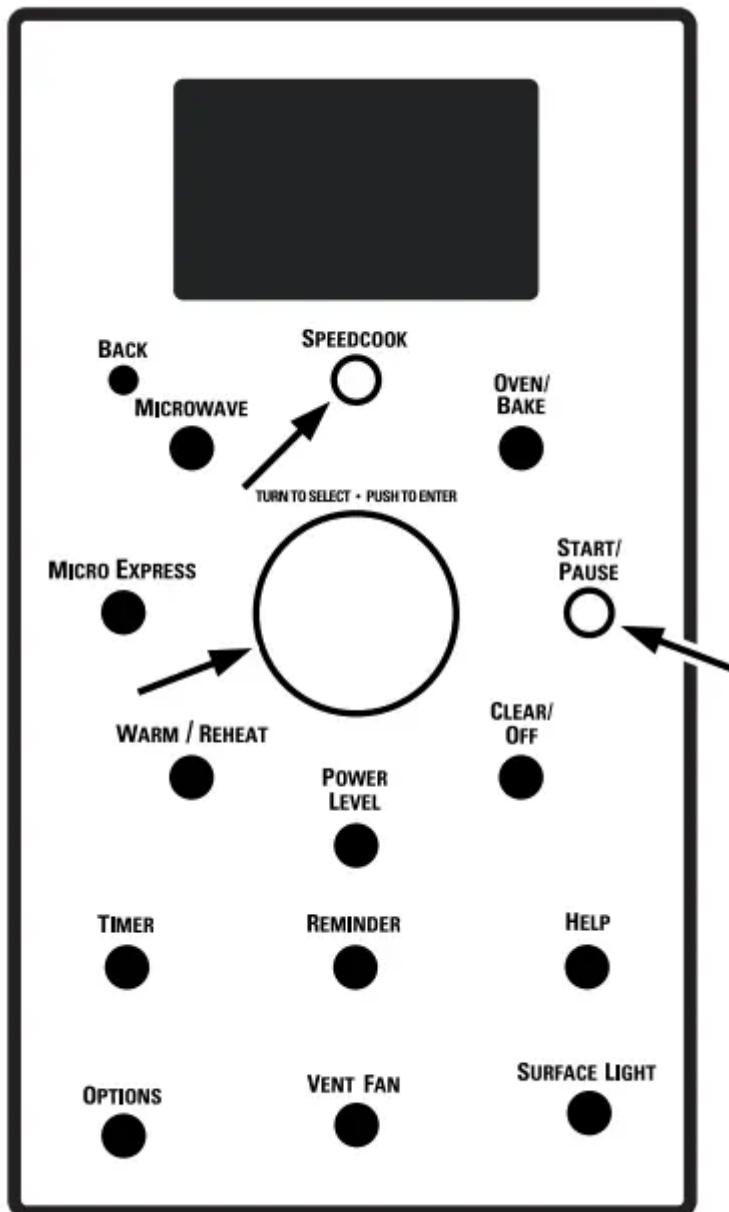

Use this time saving feature for cooking repetitive items like cookies or appetizers.

NOTE: The last program used is stored for two hours.

1. Press and hold the SPEEDCOOK button for about 3 seconds.
2. The last pre-set food will be displayed.
3. Press the START/PAUSE button or the selector dial to start cooking

Resume feature

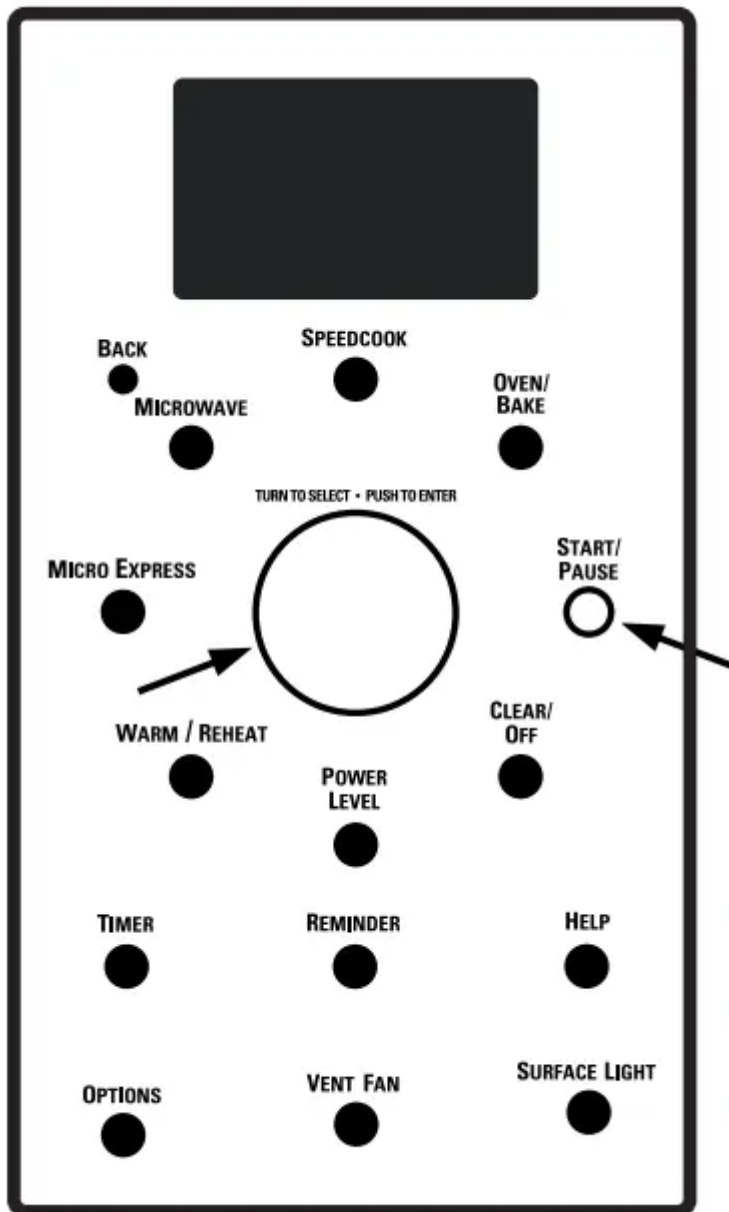

1. If your food needs to cook a bit longer, you can restart the oven by pressing the START button or selector dial.

2. RESUME COOKING will be displayed and the oven will restart immediately at 10% of the original time. The program stays in memory for 3 minutes. After that you will need to begin the program again. See To use a pre-set speedcook men

Speedcook power level

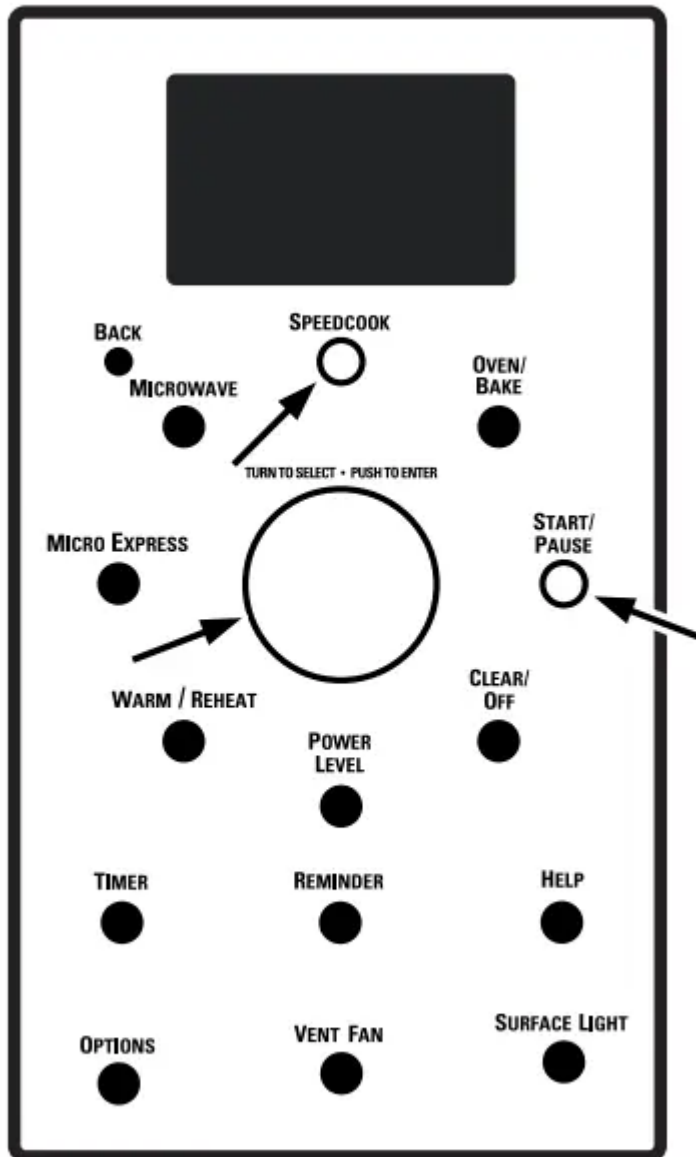

Advantium uses power from a high intensity halogen light, ceramic heaters and microwaves to cook food from the top, bottom and interior simultaneously to seal in moisture and flavor.

When using the pre-set speedcook recipes on the food menu, the power levels are already selected for you. However, these power levels can be adjusted before or during cooking. Also, the manual cook feature allows you to speedcook items not on the pre-set food menu by selecting your own cook time and power level settings.

Each power level gives you heater power and microwave energy for a certain percentage of the time.

UPPER POWER (U) controls both the upper heater and microwave power. A higher UPPER POWER setting will utilize more upper heater power, browning food faster on top. A lower UPPER POWER setting utilizes more microwave power, causing food to cook more evenly throughout.

Select a higher setting for foods such as pizza and baked goods. Select a lower setting for foods such as casseroles, meat and fish.

LOWER POWER (L) controls the lower heater. Select a higher setting to brown foods more on the bottom. Select a lower setting for less browning on the bottom.

1. Press the SPEEDCOOK button and turn the dial to select FOOD MENU or MANUAL COOK. Press the dial to enter.
2. Follow instructions from To use a pre-set speedcook menu or Manual Cook.
3. To change the power level when prompted by the display, turn the dial clockwise to increase or counterclockwise to decrease the upper power level. Press the dial to enter.
4. Turn the dial to change the lower power level. Press the dial to enter.
5. Press the START/PAUSE button or the selector dial to start cooking. If you do not want to change one of the settings, just press the dial to move to the next selection.

NOTE: Be careful when adjusting power levels so that you do not over- or undercook food.

Speedcook cookware

- Follow cookware suggestions on the oven display or in the Cookbook or Cooking Guide.
- Cookware will become hot. Oven mitts will be needed to handle the cookware.
- Place food or oven-safe cookware directly on the black tray when cooking.
- Use the black metal tray in the same way you would use a shallow baking pan or baking tray
- In addition to the cookware provided, you can use non-metal casserole dishes, pie plates and other heat-safe cookware. Place them directly on the black metal tray.
- Be sure to select a size that will rotate easily
- Place the black metal tray directly on the oven rack (turntable)

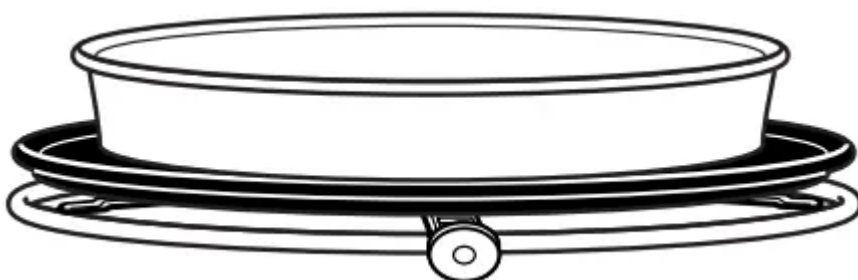

- Do not use cookware or coverings made of paper, plastic or foil when cooking during a speedcook cycle
- The black metal tray must be in place during the speedcook operations.

Manual speedcook

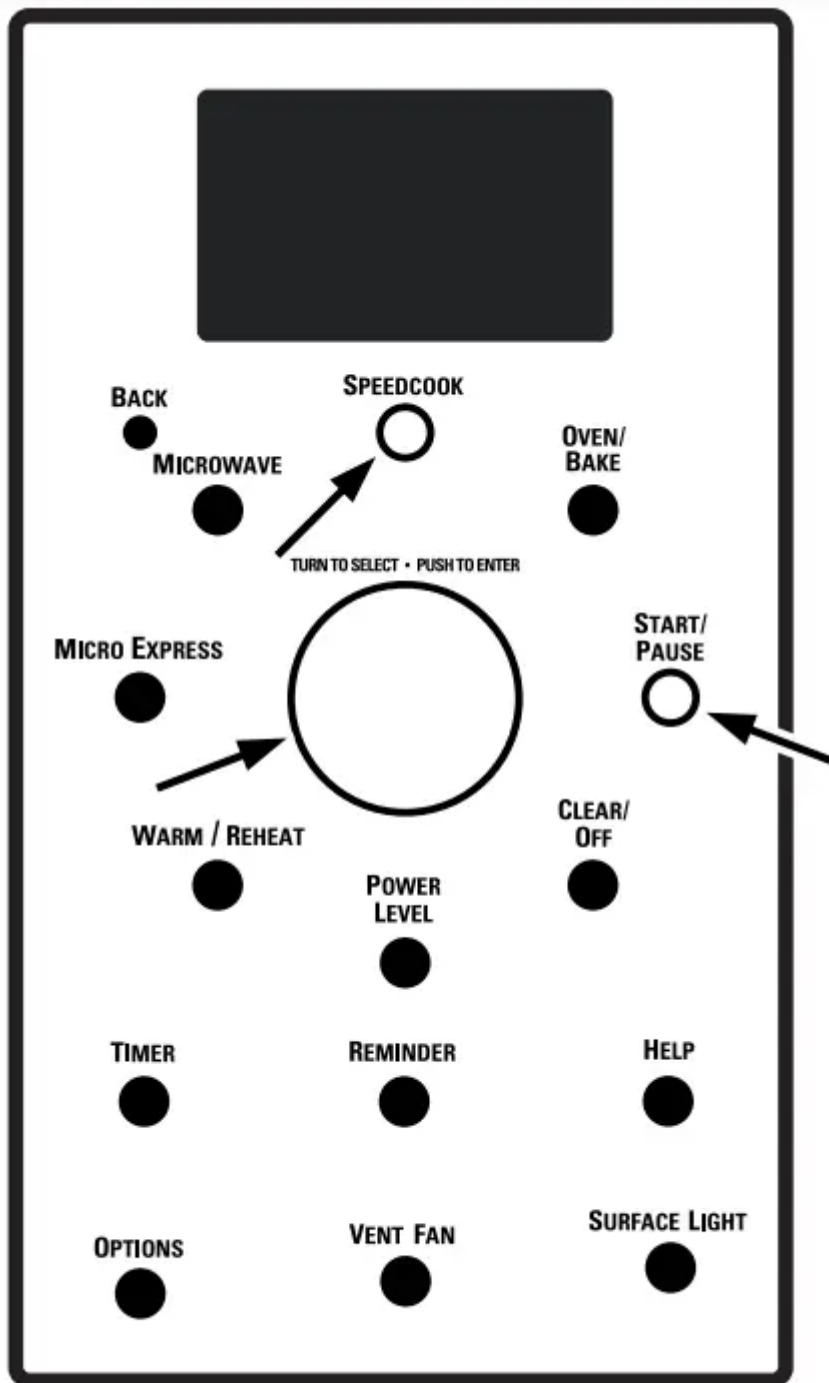

Advantium gives you the flexibility to cook your favorite dishes. If you want to cook a food item that is not among the pre-set selections, use manual speedcook.

1. Press the SPEEDCOOK button. If no entries are made within 15 seconds, the display will revert back to the time of day.
2. Turn the selector dial to MANUAL COOK.
3. Turn the selector dial to select the cooking time. Press the dial to enter.

The display will prompt you to select UPPER POWER and LOWER POWER.

4. Turn the dial clockwise to increase or counterclockwise to decrease the upper power level. Press the dial to enter.

5. Turn the dial to change the lower power level. Press the dial to enter.

6. Press the START/PAUSE button or press the selector dial to start cooking.

For power level and cooking time suggestions, use your cooking guide or cook book.

Speedcook recipe—to enter and save

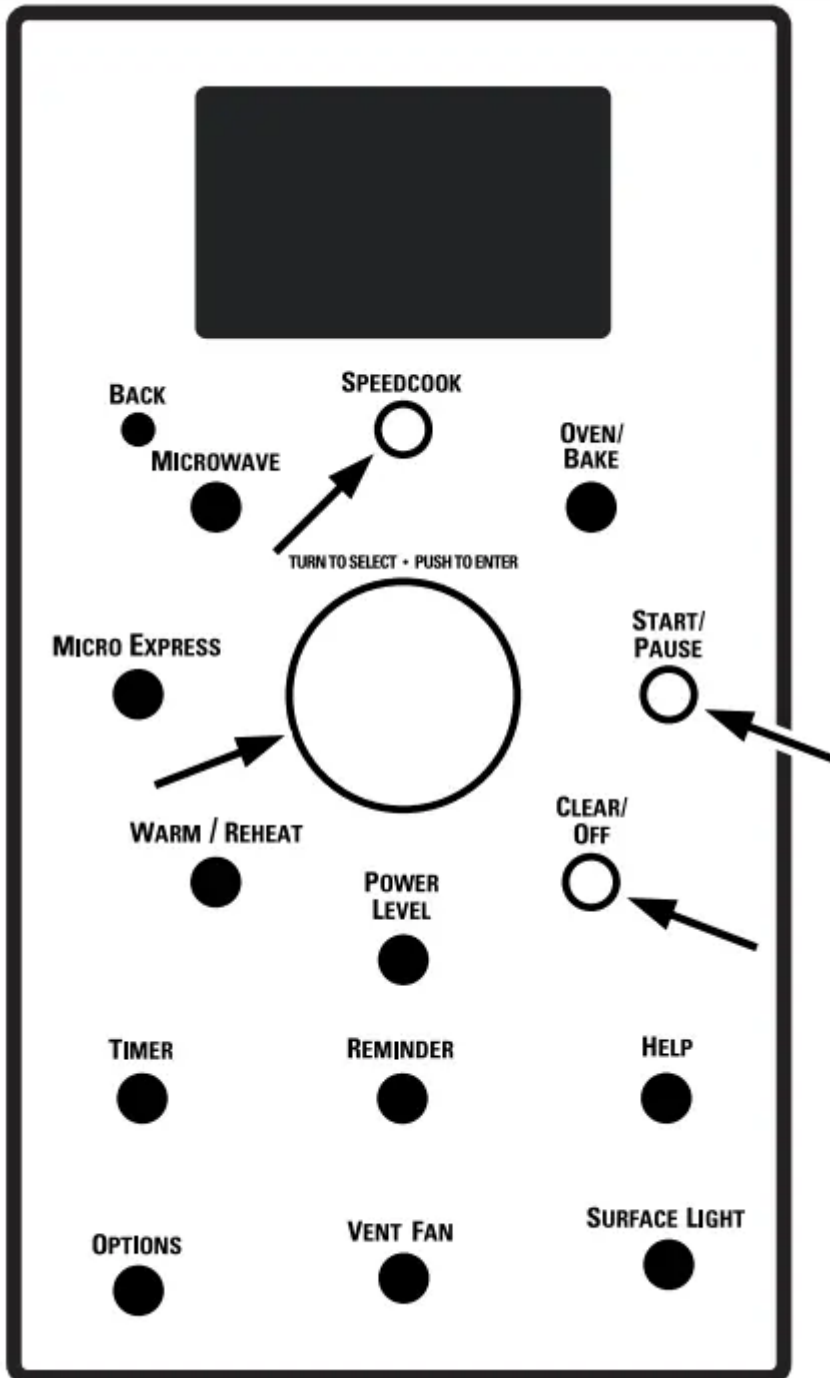

Create up to 30 of your own Speedcook recipes, or customize an existing custom recipe to suit your tastes. Once it's done, your food cooks just the way you want it every time!

1. Press the SPEEDCOOK button.
2. Turn the dial until MY RECIPES appears. Press the dial to enter.
3. Turn the dial until appears. Press the dial to enter.
4. SELECT COOK TIME appears. Turn the dial to select the cooking time. Press the dial to enter.

The display will prompt you to select UPPER POWER and LOWER POWER.

5. Turn the dial clockwise to increase or counterclockwise to decrease the upper power level. Press the dial to enter.
6. Turn the dial to change the lower power level. Press the dial to enter.
7. Spell out the food name by turning the selector dial to advance through the available characters. Press the dial to enter a character. When you have entered the entire name, press START/PAUSE. You may change previously entered characters by pressing the BACK button.
8. RECIPE ADDED appears. To begin cooking, press the START/ PAUSE button. To store the recipe without cooking, press the CLEAR/OFF button.

For power level and cooking time suggestions, use your cooking guide or cook book.

Speedcook recipe—to find and use

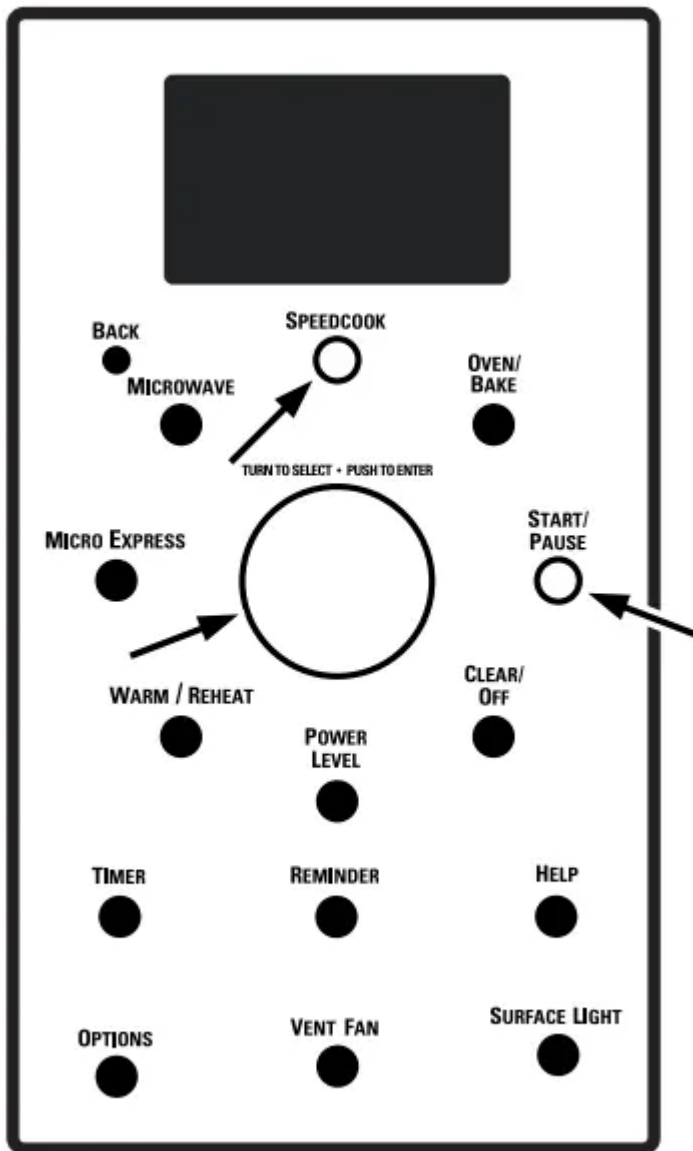

To find and use stored custom speedcook recipes:

1. Press the SPEEDCOOK button.
2. Turn dial to MY RECIPES and press to enter.
3. FOOD NAME and the recipe names you have previously entered will appear.
4. Turn dial until the recipe you want is displayed and press the dial to enter.
5. Press the START/PAUSE button or press the selector dial to start cooking.

Speedcook recipe—to adjust or change

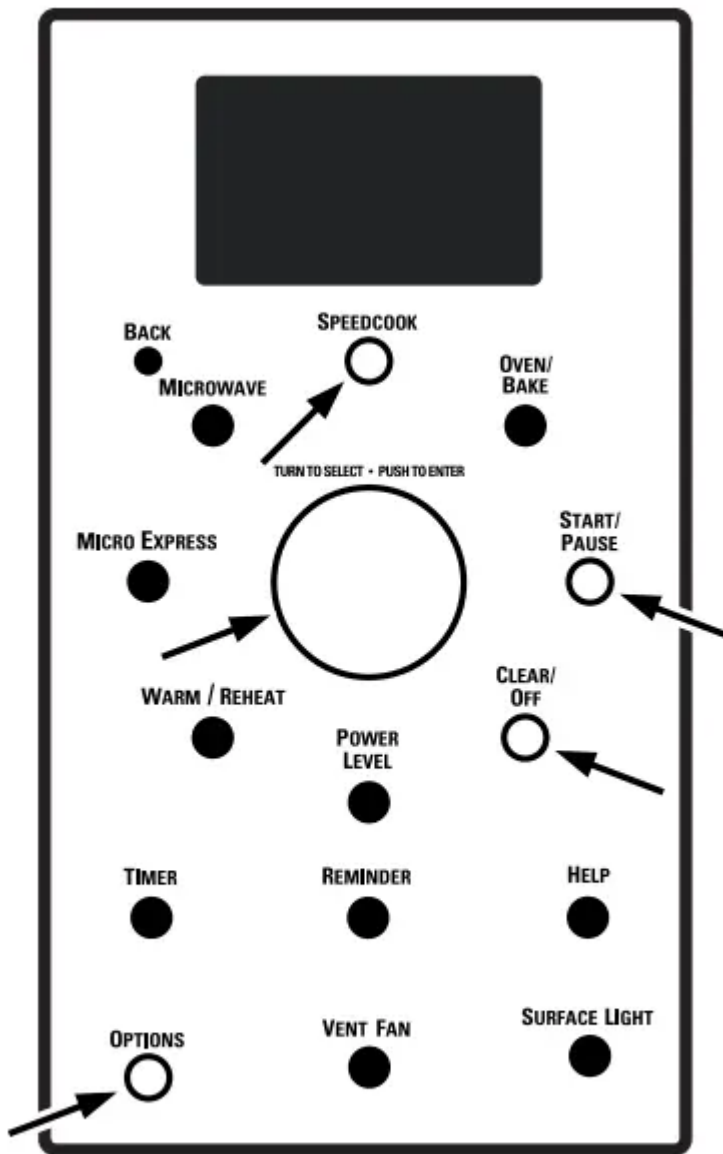

To adjust or change stored custom speedcook recipes:

1. Press the SPEEDCOOK button.
2. Turn the dial until MY RECIPES appears. Press the dial to enter.
3. Turn the dial to the recipe you want to change. Press the dial to enter.
4. Press the OPTIONS button.
5. Turn the dial to select CHANGE RECIPE. Press the dial to enter.
6. The display will prompt you to SELECT COOK TIME, then select UPPER POWER, LOWER POWER and FOOD NAME. Turn the dial and press to enter the appropriate settings.

(For more detailed instructions, follow steps 4 through 7 in the section Speedcook recipe—to enter and save.)

7. RECIPE ADDED appears. To begin cooking press the START/PAUSE button. To store the recipe without cooking, press the CLEAR/OFF button.

For power level and cooking time suggestions, use your cooking guide or cook book

Speedcook recipe—to delete

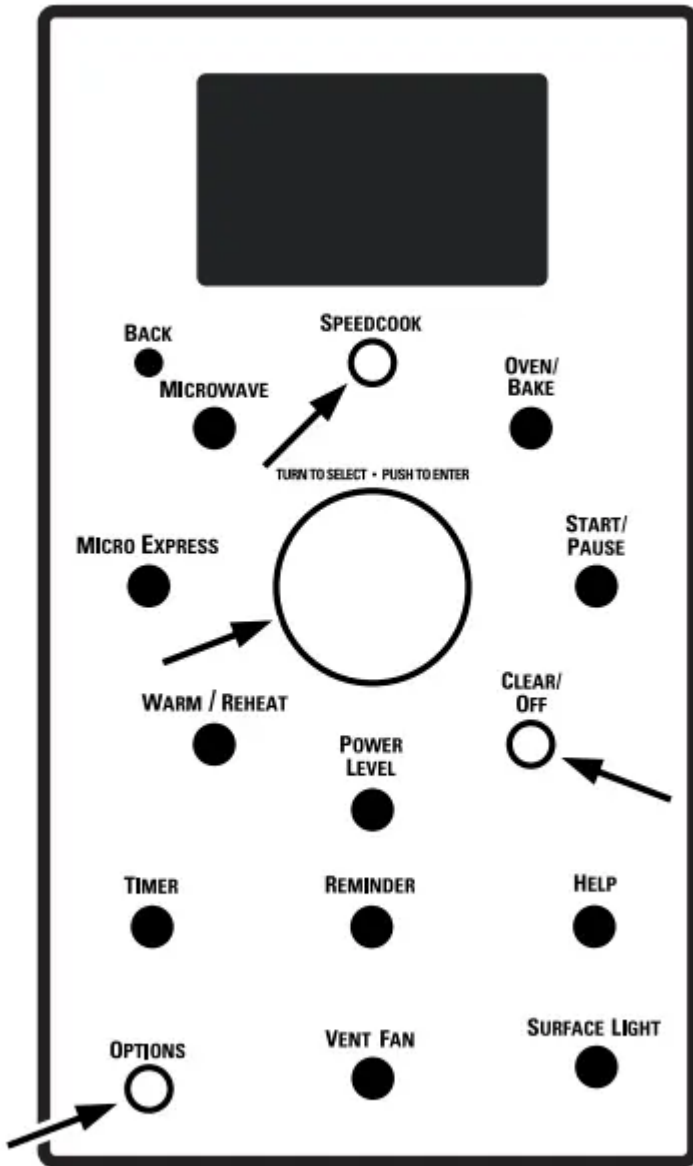

To delete stored custom speedcook recipes:

1. Press the SPEEDCOOK button.
2. Turn the dial until MY RECIPES appears and press the dial to enter.
3. Turn dial to the recipe you want to delete and press the dial to enter.
4. Press the OPTIONS button.

5. Turn the dial to select DELETE RECIPE, and press the dial to enter. This deletes the recipe. You may now enter and save a new recipe or press CLEAR/OFF to return to the clock display

Things that are normal during speedcooking

Cooking Times

- When speedcooking preprogrammed foods, you may see OPTIMIZING COOK TIME in the display several seconds after you press START. The oven automatically senses the electrical voltage level in your home and adjusts the cooking time up or down for proper cooking.

Fan/Vent

- The fan will come on during cooking. At the end of cooking, the automatic fan will continue to run for a short time, and the display will read Oven is Cooling. The fan will automatically shut off when the internal parts of the oven have cooled.
- The exhaust fan may come on automatically if the cooktop is in use
- The oven vent will emit warm air while the oven is on.

Lights

- When the oven is on, light may be visible around the door or outer case.
- The heaters will dim and cycle on and off during a speedcook cycle, sometimes even at full power levels. This is normal. The oven senses the heat level and adjusts automatically

Heaters

- No preheating is required. The oven begins cooking immediately.
- The door and inside of the oven will be very hot. Use caution when opening the door and removing food.
- Do not use cookware or coverings made of paper, plastic or foil when cooking during a speedcook cycle.
- When cooking for an extended period of time, the oven may automatically reduce the power levels to maintain the appropriate level of oven heat.

Sounds

- Clicks and a fan blowing are normal sounds during cooking. The relay board is turning components on and off.

Microwaving

Baking

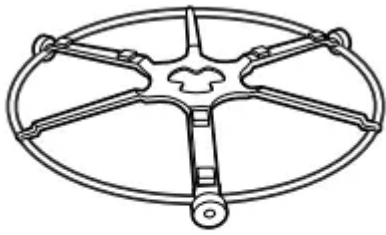

The oven rack (turntable) must always be in place when using the oven.



Put food or oven-safe cookware directly on the black metal tray to bake.

Baking allows you to cook foods the same way as a conventional oven, using a heating element to raise the temperature of the air inside the oven. Any oven temperature from 250°F to 450°F may be set. A fan gently circulates this heated air throughout the oven, over and around the food, producing golden brown exteriors and rich, moist interiors.

Because the heated air is kept constantly moving, not permitting a layer of cooler air to develop around the food, some foods cook slightly faster than in regular oven cooking.

Before you begin, make sure the oven rack (turntable) is in place. Use the black metal tray at all times when baking.

Caution: When baking, remember that the oven, door and dishes will be very hot!

Bake with preheat

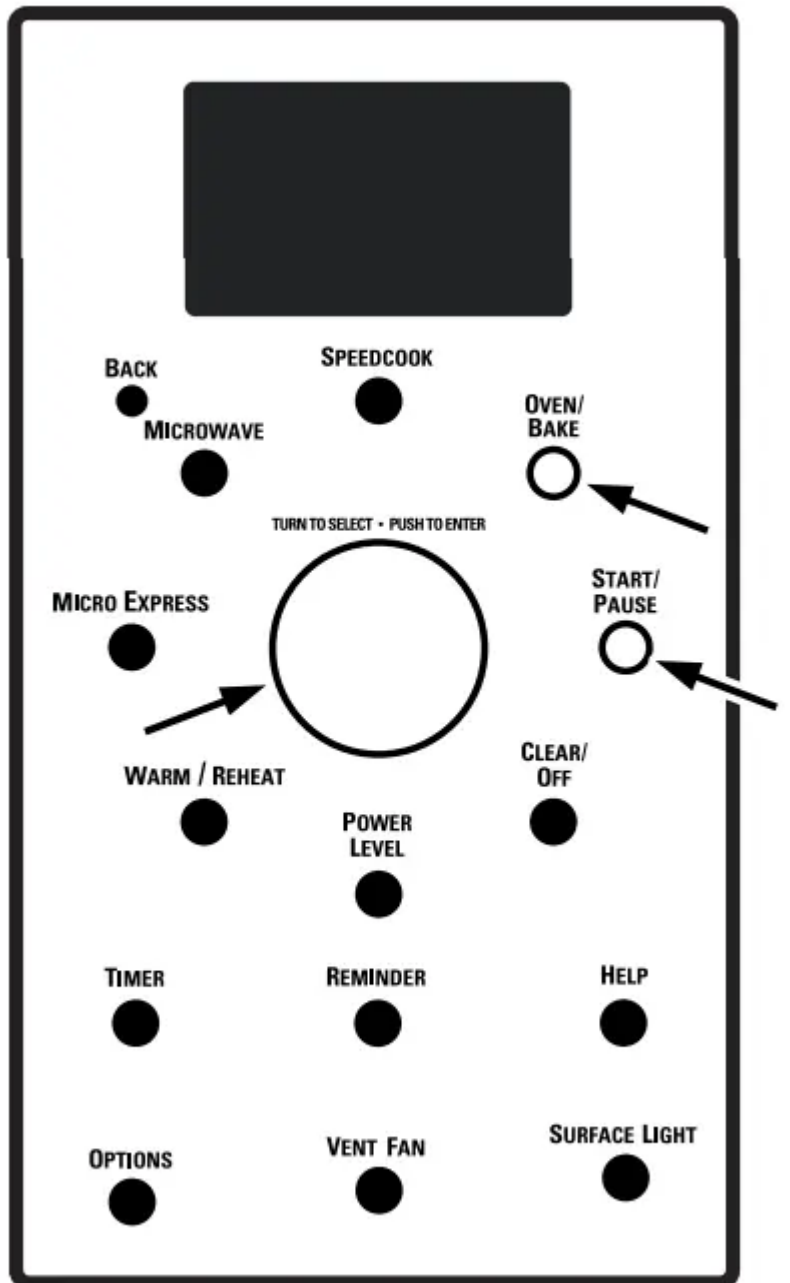

1. Press the oven/bake button.
2. When using the OVEN/BAKE mode to cook baked goods such as cakes, brownies, cookies, pies, rolls, etc., reduce the oven temperature 25°F–40°F from the recipe to prevent overbrowning of baked goods. Turn the dial to set the oven temperature and press dial to start preheating. Do not place the food in the oven. (You will be prompted to enter the cook time, after the oven is preheated.)
3. Press the start/pause button to start preheating.
4. When the oven is finished preheating, it will signal. If you do not open the door within 1 hour, the oven will turn off automatically. Open the oven door and, using caution, place the food in the oven.

5. Close the oven door. Turn the dial to set the cook time and press START/PAUSE to start cooking. When cooking is complete, the oven will signal and turn off.

You may change the oven temperature during preheating by pressing the power level button and turning the dial to select the new temperature.

If the oven door is opened during cooking, PAUSE will appear in the display. Close the door and press start/pause.

Cook times are shown in minutes and can be a maximum of 179 minutes. Time can be changed during cooking by turning the dial

Bake without preheat

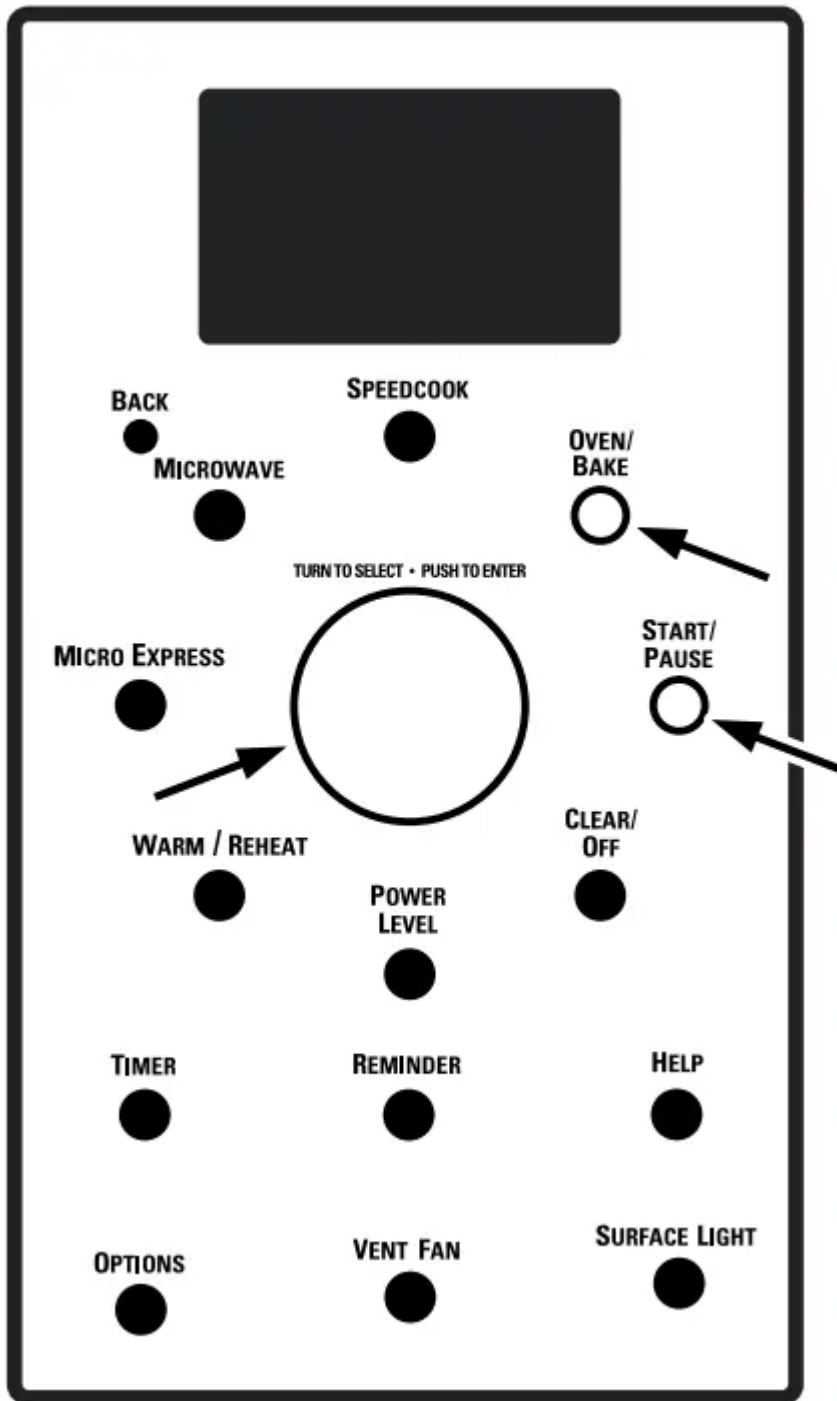

1. If your recipe does not require preheating, press the oven/bake button.
2. When using the OVEN/BAKE mode to cook baked goods such as cakes, brownies, cookies, pies, rolls, etc., reduce the oven temperature 25°F–40°F from the recipe to prevent overbrowning of baked goods. Turn the dial to set the oven temperature and press to enter.
3. To bypass preheating, press the dial again.
4. Turn the dial to set the cook time and press to enter.
5. Place the food in the oven, and press the Start/pause button to start the oven.

If the oven door is opened during cooking, PAUSE will appear in the display. Close the door and press start/pause.

Cook times are shown in minutes and can be a maximum of 179 minutes. Time can be changed during cooking by turning the dial

Warming

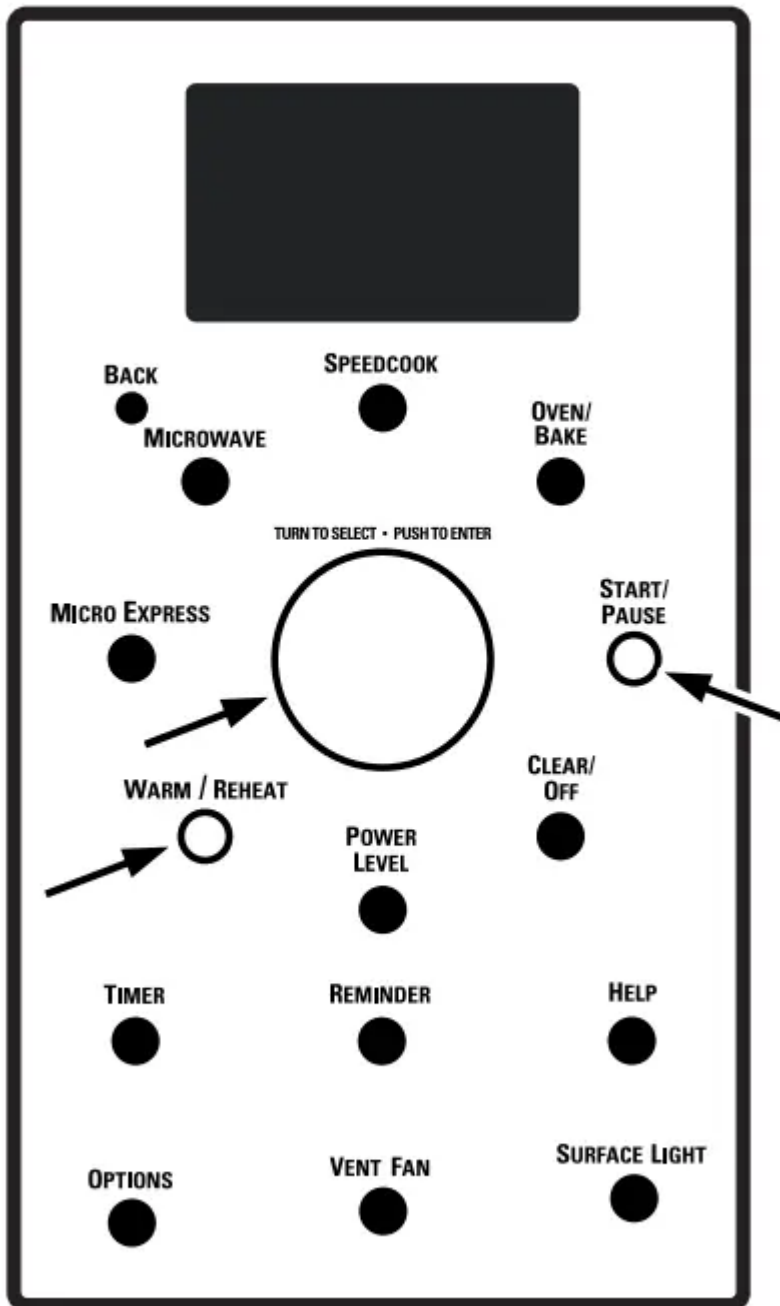

The warming feature will keep hot, cooked foods at serving temperature. Always start with hot food. Use cookware and utensils that can withstand temperatures up to 230°F.

1. Press the WARM/REHEAT button.
2. Turn the dial to select WARMING. Press the dial to enter.

3. Turn the dial to select the oven temperature.

LOW.....140–160°F

MEDIUM160–195°F

HIGH195–230°F

4. Turn the dial to select the level of moisture you want. Press the dial to enter.

If the oven door is opened during warming, PAUSE will appear in the display. Close the door and press START/PAUSE.

Temperature and Moisture Selection Chart

Food Type	Control Setting	Moisture Setting
<i>Bread, hard rolls</i>	<i>MEDIUM</i>	<i>CRISP</i>
<i>Bread, soft rolls</i>	<i>MEDIUM</i>	<i>MOIST</i>
<i>Casseroles</i>	<i>MEDIUM</i>	<i>MOIST</i>
<i>Fried foods</i>	<i>HIGH</i>	<i>CRISP</i>
<i>Meats* and fish</i>	<i>MEDIUM</i>	<i>CRISP</i>
<i>Pancakes, waffles</i>	<i>HIGH</i>	<i>CRISP</i>
<i>Pizza</i>	<i>HIGH</i>	<i>CRISP</i>
<i>Potatoes, baked</i>	<i>HIGH</i>	<i>CRISP</i>
<i>Potatoes, mashed</i>	<i>MEDIUM</i>	<i>MOIST</i>
<i>Poultry</i>	<i>HIGH</i>	<i>MOIST</i>
<i>Tortilla Chips</i>	<i>LOW</i>	<i>CRISP</i>
<i>Vegetables</i>	<i>MEDIUM</i>	<i>MOIST</i>

Tips for Crisp Foods:

- Leave food uncovered.
- Do not use plastic containers or plastic wrap.
- Preheat prior to use according to recommended times.

Tips for Moist Foods:

- Cover food with lid or aluminum foil
- Do not put water in the warming pan.
- Do not use plastic containers or plastic wrap.
- Preheat prior to use according to recommended times.

To Crisp Stale Items

- Place food or dishes directly on the black metal tray.
- Preheat on LOW setting and select CRISP.
- Check crispness after 45 minutes. Add time as needed.



Timed Reheat

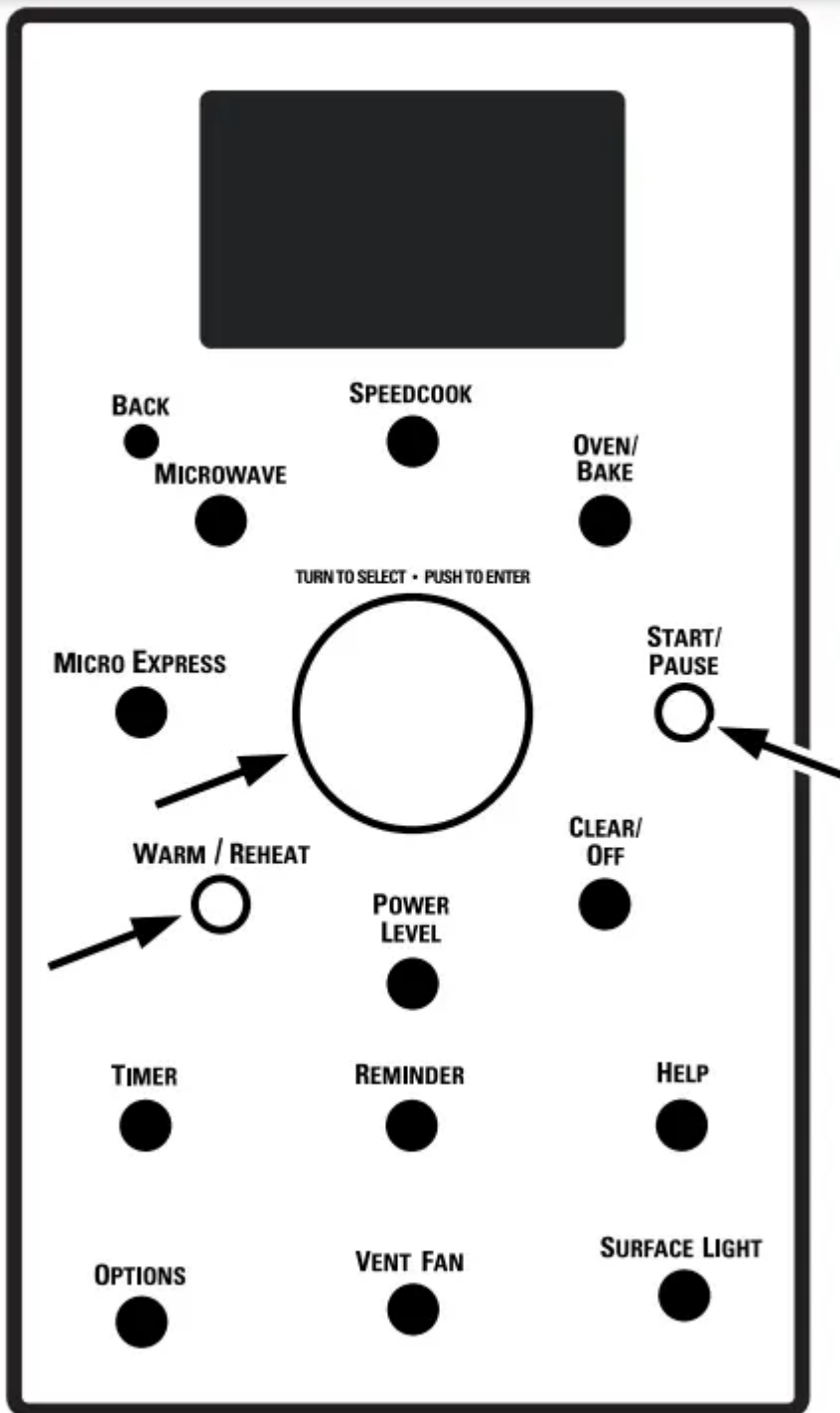

The Timed Reheat feature reheats servings of previously cooked foods or a plate of leftovers. Timed Reheat uses a combination of heaters and microwave power. A microwave-only reheat feature is also available in the MICROWAVE selections.

1. Press the WARM/REHEAT button.
2. Turn the dial to select REHEAT. Press the dial to enter.
3. Turn the dial to set the reheat time and press to enter.

4. Press the START/PAUSE button to start the oven.

If the oven door is opened during cooking, PAUSE will appear in the display. Close the door and press START/PAUSE.

After removing food from the oven, stir, if possible, to even out the temperature. If the food is not hot enough, reheat for more time. Reheated foods may have wide variations in temperature. Some areas of food may be extremely hot.

Place the food in a non-metallic container on the black metal tray. The cookware will get hot.

Use cookware and utensils that can withstand temperatures up to 275° F

Using the microwave features

Make sure the oven rack (turntable) and glass microwave tray are in place. Place food or microwavable container directly on the glass microwave tray to cook your food.

Center the tray on the oven rack (turntable). The tray will not lock onto the center hub

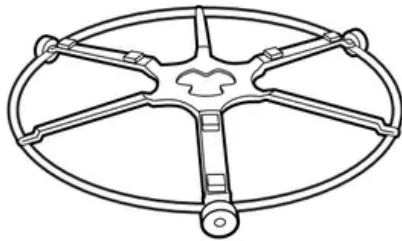

The oven rack (turntable) must always be in place when using the oven.

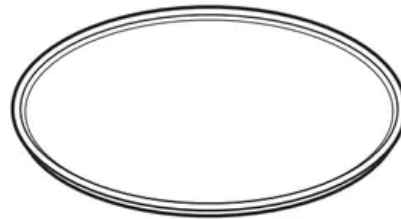

The glass microwave tray should always be in place when microwaving.

Cookware

- Make sure that cookware is suitable for microwaving.
- Place food or microwavable container directly on the glass microwave tray to cook your food.

MICROWAVE PRE-SET FOOD SELECTIONS:

- Bacon
- Beverage
- Defrost (Auto and Time)
- My Recipes
- Popcorn
- Reheat (one serving)
- Soup
- Time cook
- Vegetables (fresh, frozen, canned)

How to use pre-set microwave selections

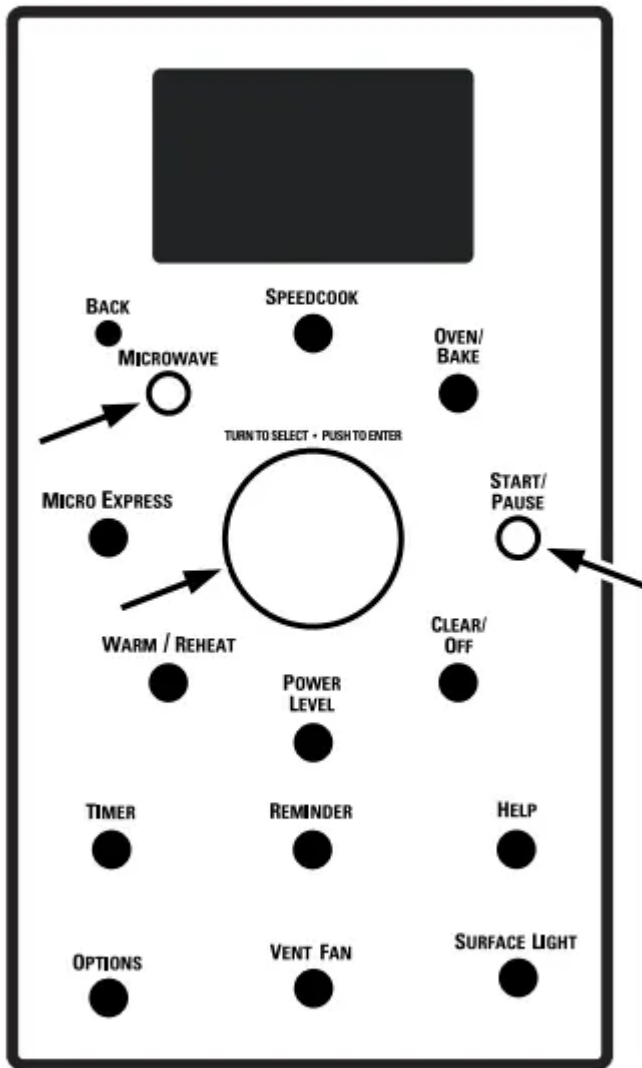

1. Press the MICROWAVE button. If no selection is made within 15 seconds, the display will revert back to the time of day.
2. Turn the dial to find the food you want to cook. Press the dial to enter.
3. If required, the oven will prompt you to select amount, weight or size. Turn the dial and press after each selection.
4. Press the dial or the START/ PAUSE button to start cooking. To review settings during cooking, press the selector dial.

If the door is opened during cooking, the oven will stop and PAUSE will appear in the display. Close the door and press START/ PAUSE to resume cooking.

If you enter an undesired selection at any time, simply press the BACK button to return to the previous step, or press the CLEAR/OFF button and re-enter the desired selections.

Time Cook

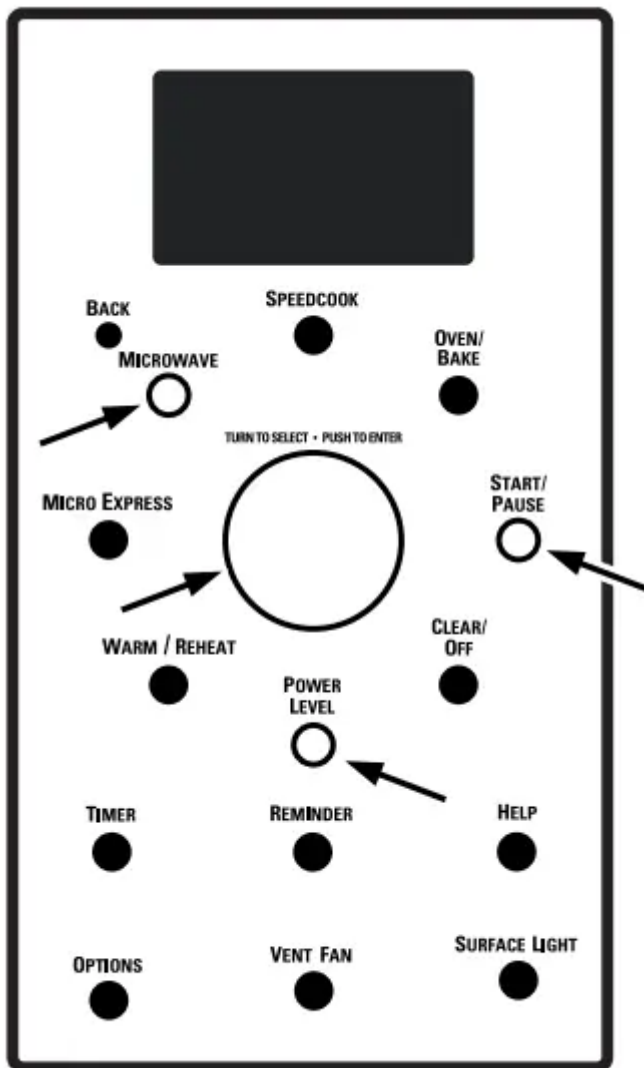

Use Time Cook to microwave food that is not in the recipe section.

- The power level is automatically set at high, but you can change it for more flexibility.

1. Press the MICROWAVE button.
2. Turn the dial to TIME COOK and press the dial to enter.
3. Turn the dial to set the time and press the dial to enter.
4. To change the power level if you don't want full power, press the POWER LEVEL button. Turn the dial to select. Press the dial to enter.
5. Press the dial or the START/ PAUSE button to start cooking. You may open the door during TIME COOK to check the food. Close the door and press START to resume cooking

Micro Express

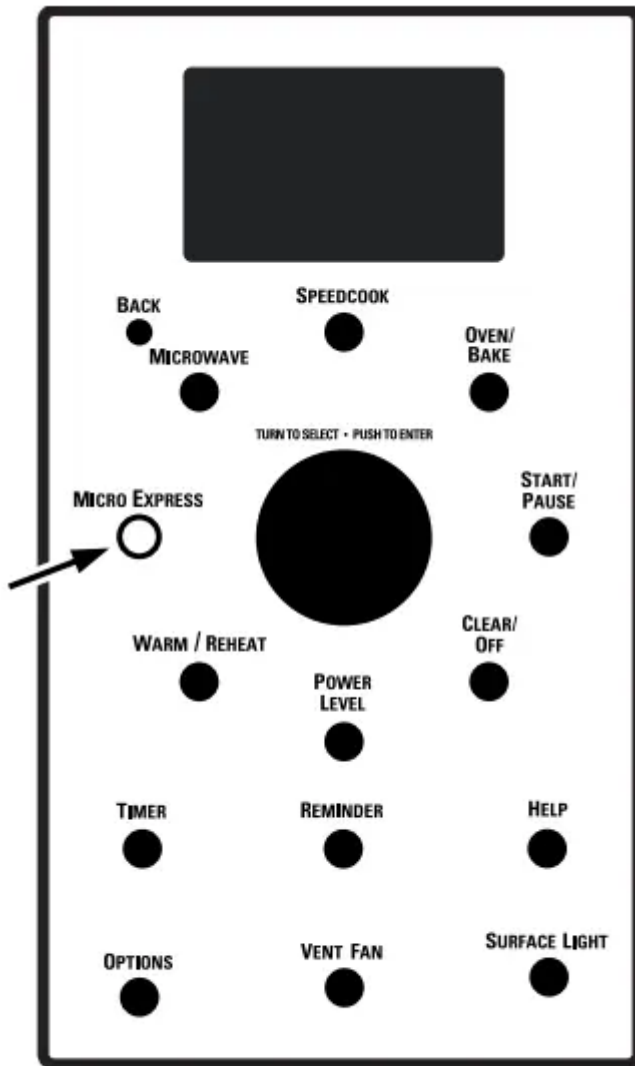

Press MICRO EXPRESS for 30 second increments of microwave cooking time. Oven starts immediately. You may add or subtract time by turning the dial.

You may also add time in 30 second increments by pressing MICRO EXPRESS again.

Microwave power level

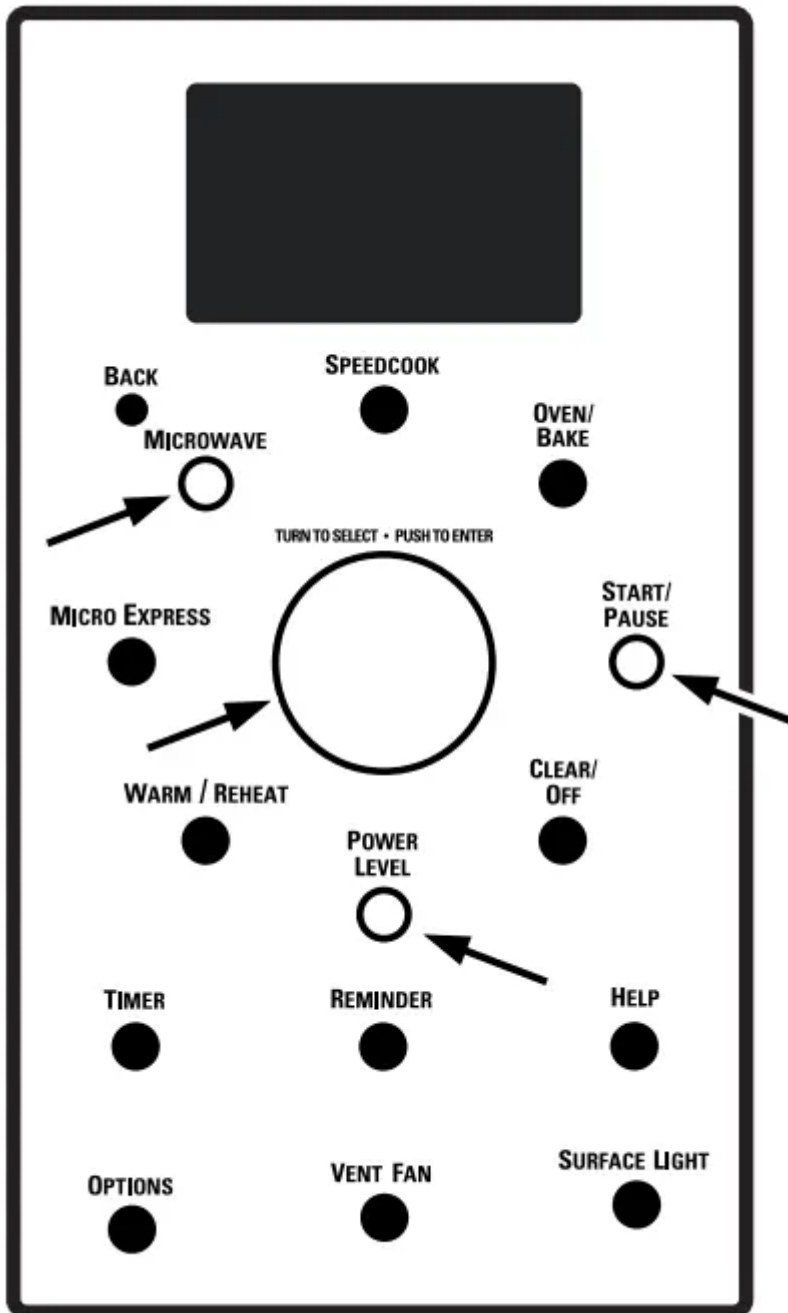

1. First, follow directions for TIME COOK, TIME DEFROST or MICRO EXPRESS.
2. Press the POWER LEVEL button.
3. Turn the dial clockwise to increase and counterclockwise to decrease the power level. Press the dial to enter.
4. Press the dial or the START/PAUSE button to start cooking.

- You can change the power level before or during a cooking program.

Here are some examples of uses for various power levels:

High 10: Fish, bacon, vegetables, boiling liquids.

Med-High 7: Gentle cooking of meat and poultry; baking casseroles and reheating.

Medium 5: Slow cooking and tenderizing for stews and less tender cuts of meat.

Low 2 or 3: Defrosting; simmering; delicate sauces.

Warm 1: Keeping

Cooking tips

- When cooking bacon, layer strips on a plate. Cover each layer with a paper towel.
- When cooking vegetables, use a microwave-safe casserole or bowl. Cover with a lid or vented plastic wrap.
- For frozen vegetables, follow the package instructions for adding water.
- For fresh vegetables, add two tablespoons of water for each serving.

Microwave recipe—to enter and save

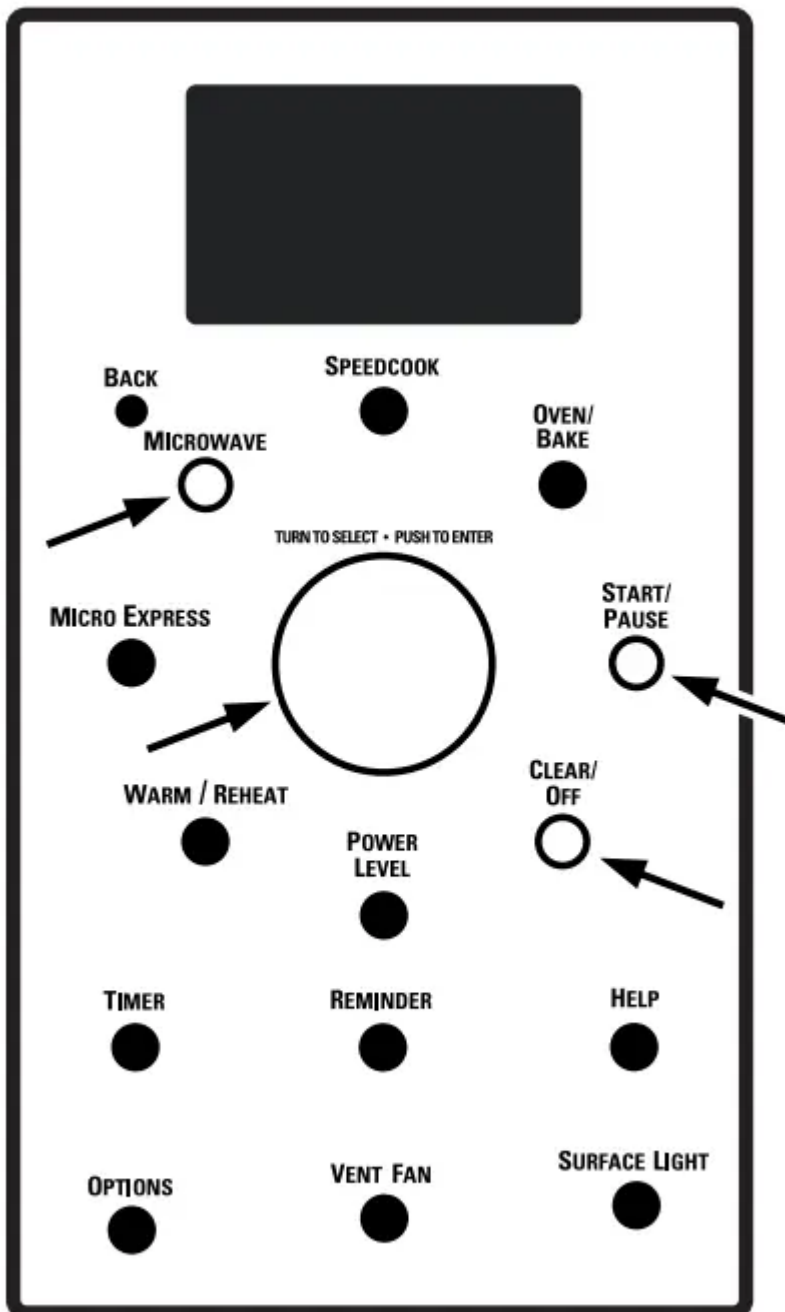

Create and store up to 10 of your own microwave recipes.

1. Press the MICROWAVE button.
2. Turn dial until MY RECIPES appears. Press the dial to enter.
3. Turn dial until appears. Press the dial to enter.
4. SELECT COOK TIME appears. Turn the dial to select the cooking time you want. Press the dial to enter.
5. Turn the dial to change the power level and press to enter.

6. Spell out the food name by turning the selector dial to advance through the available characters. Press the dial to enter a character. When you have entered the entire name, press START/PAUSE. You may change previously entered characters by pressing the BACK button.

7. RECIPE ADDED appears. To begin cooking, press the START/PAUSE button or press the CLEAR/OFF button to store the recipe without cooking

Microwave recipe—to find and use

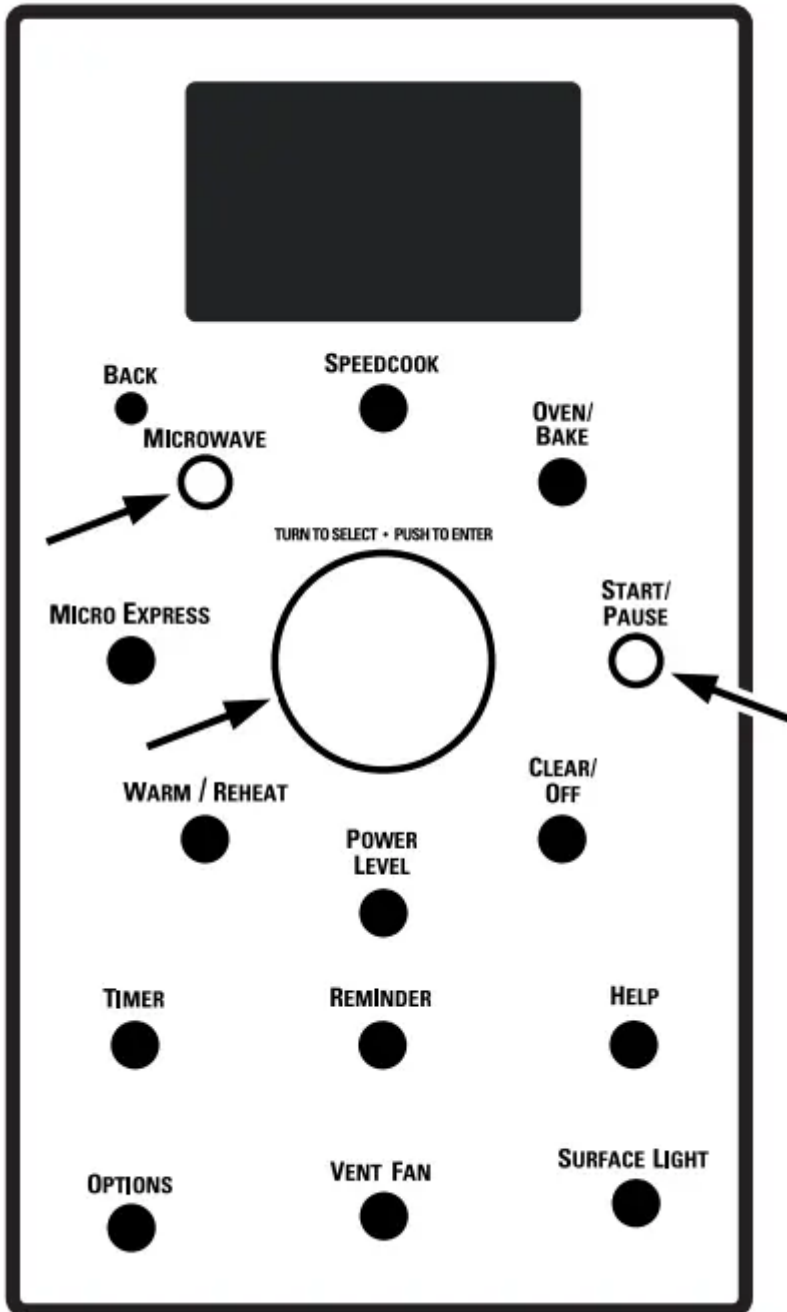

To find and use stored custom microwave recipes:

1. Press the MICROWAVE button.
2. Turn dial to MY RECIPES and press the dial to enter.



3. FOOD NAME and the recipe names you entered will appear.
4. Turn dial to your recipe and press the dial to enter.
5. Press the START/PAUSE button or the selector dial to start cooking.

Microwave recipe—to adjust or change

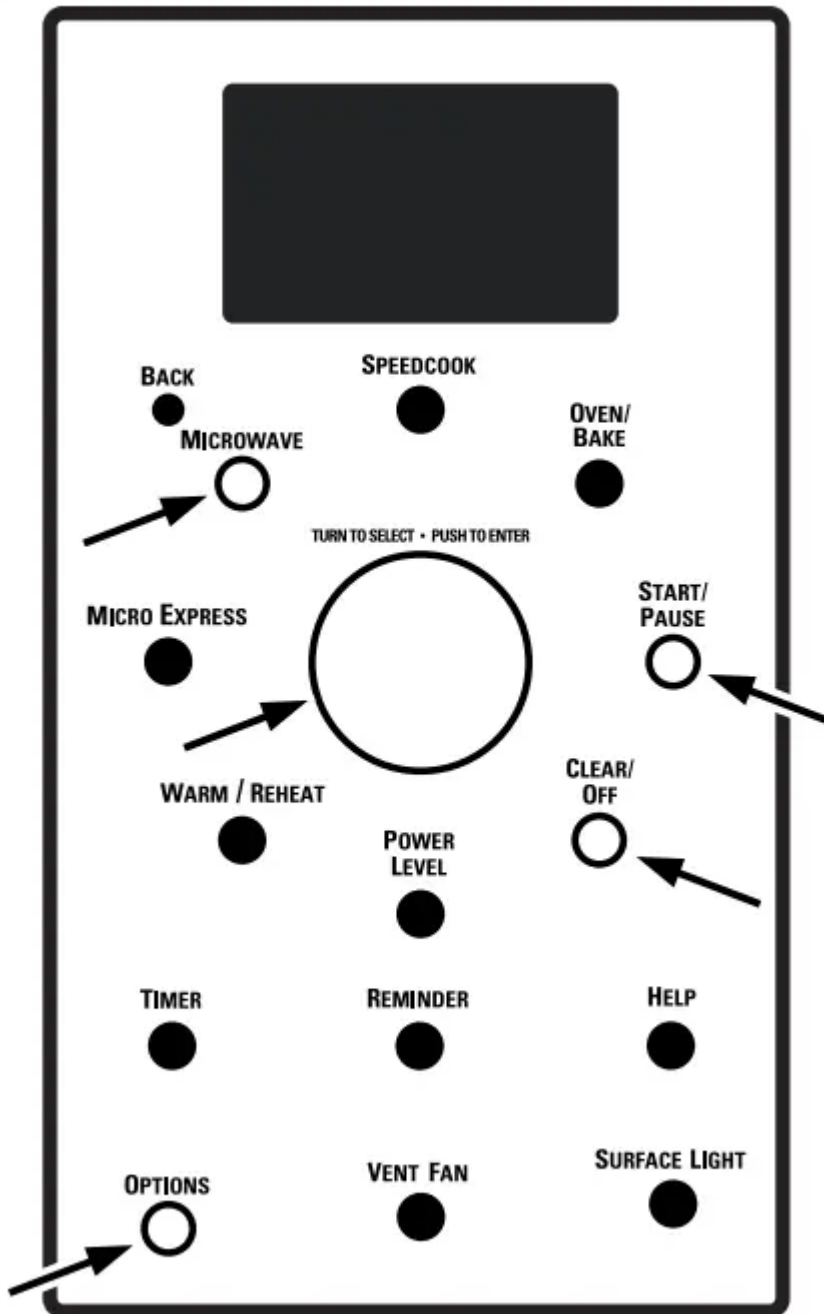

To adjust or change stored custom microwave recipes:

1. Press the MICROWAVE button.
2. Turn dial to MY RECIPES and press the dial to enter.
3. Turn the dial to the recipe you want to change. Press the dial to enter.



4. Press the OPTIONS button.
5. Turn the dial to select CHANGE RECIPE. Press the dial to enter
6. Turn the dial to select the cook time and press the dial to enter.
7. Turn the dial to select the POWER LEVEL and press the dial to enter.
8. RECIPE ADDED appears. To begin cooking, press the START/PAUSE button or press the CLEAR/OFF button to store the recipe without cooking.

Microwave recipe—to delete

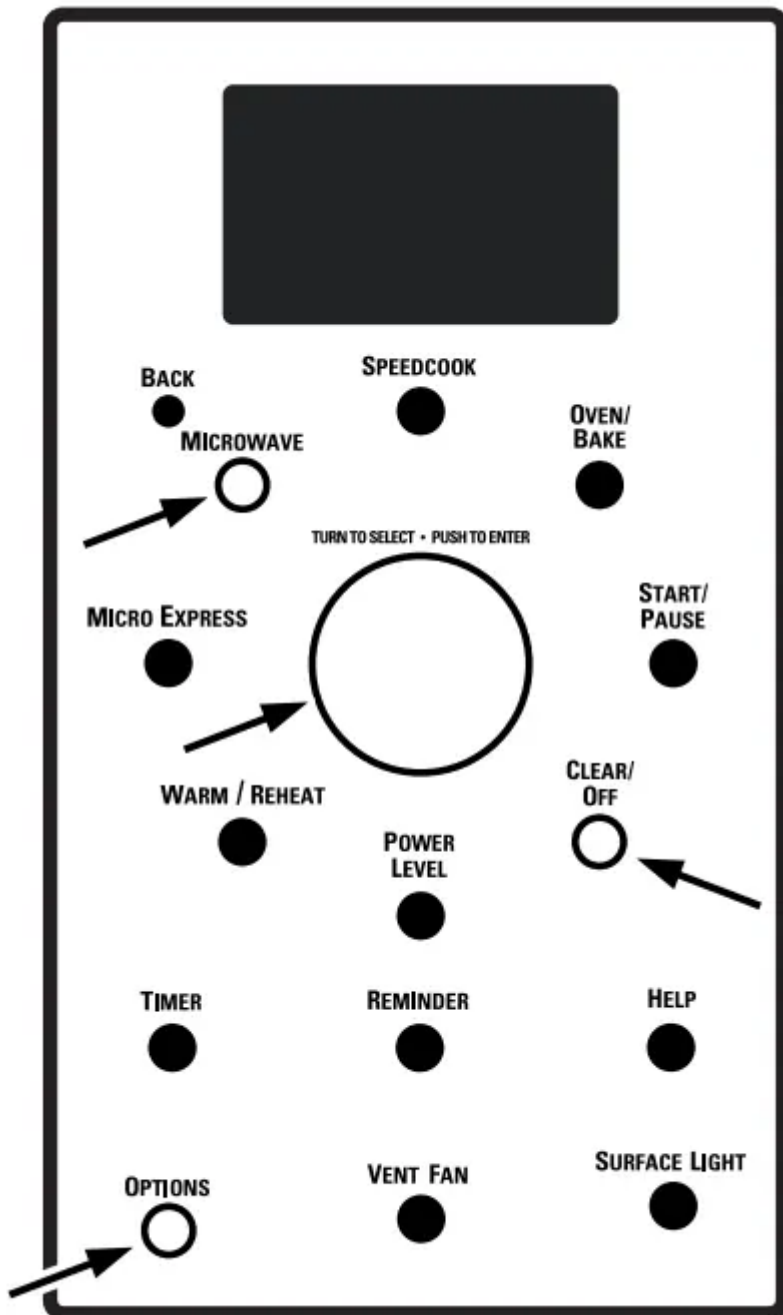

To delete stored custom microwave recipes:

1. Press the MICROWAVE button.
2. Turn dial to MY RECIPES and press the dial to enter.
3. Turn the dial to the recipe you want to delete. Press the dial to enter.
4. Press the OPTIONS button.
5. Turn the dial to select DELETE RECIPE, and press the dial to enter. This deletes the recipe. You may now enter and save a new recipe or press CLEAR/OFF to return to the clock display.

Auto defrost

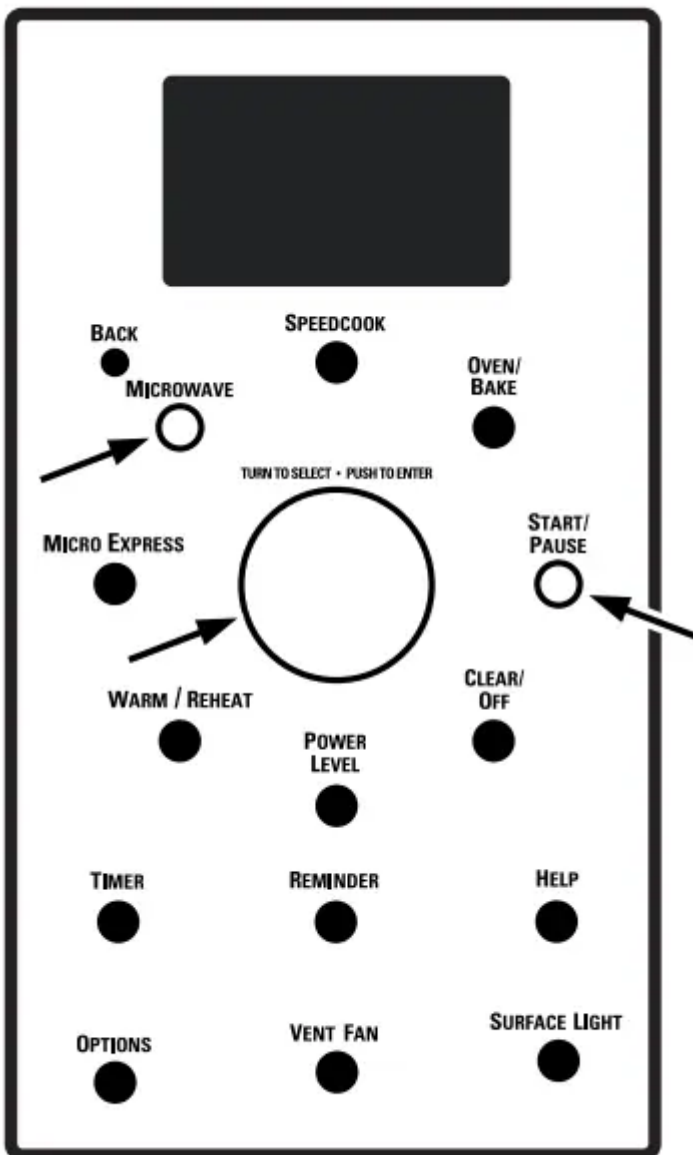

Auto Defrost automatically sets the defrosting times and power levels to give even defrosting results for meats, poultry and fish weighing up to six pounds.

1. Remove food from the package and place it on a microwave-safe dish.
2. Press the MICROWAVE button.

3. Turn the dial to DEFROST-AUTO. Press the dial to enter.
4. Turn the dial to the food weight, using the Conversion Guide at right. For example, dial 1.2 for 1.2 pounds (1 pound, 3 oz.) Press the dial to enter.
5. Press the dial or START/PAUSE button to start defrosting. 6. Turn the food over when the oven signals TURN FOOD OVER
 - Remove defrosted meat or shield warm areas with small pieces of foil for even defrosting.
 - After defrosting, most meats need to stand 5 minutes to complete defrosting. Large roasts should stand for about 30 minutes.

Conversion Guide

If the weight of food is stated in pounds and ounces, the ounces must be converted to tenths (.1) of a pound.

<i>Weight of Food in Ounces</i>	<i>Enter Food Weight (tenths of a pound)</i>
1-2	.1
3	.2
4-5	.3
6-7	.4
8	.5
9-10	.6
11	.7
12-13	.8
14-15	.9

Time defrost



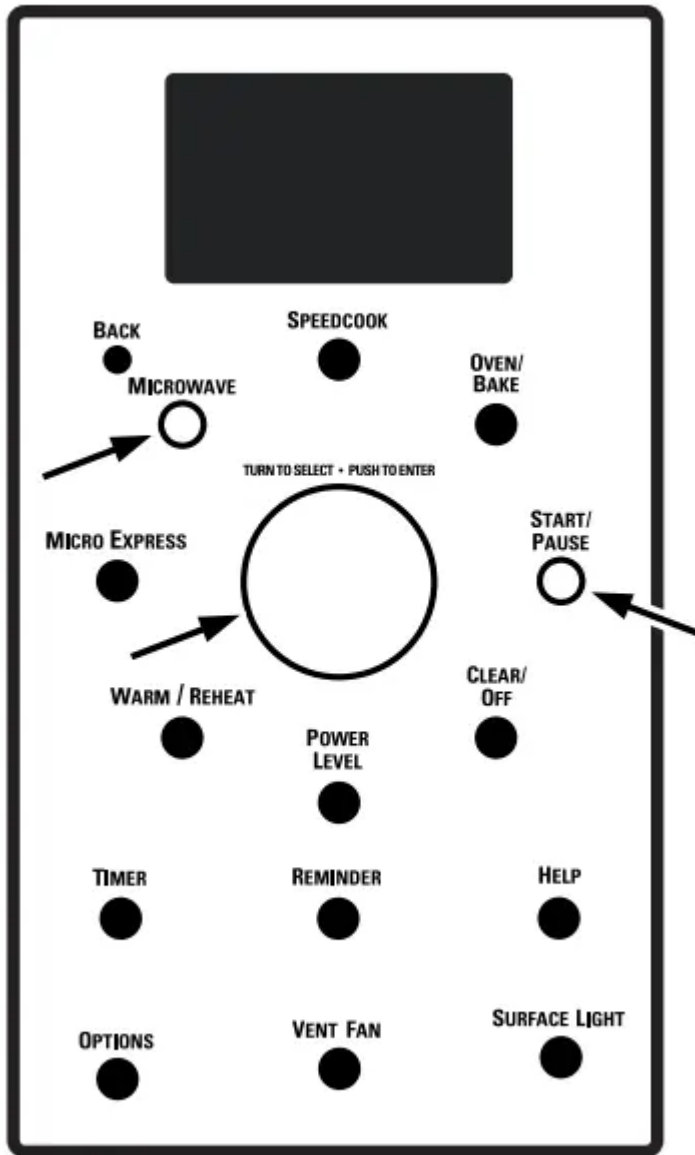

Use Time Defrost to defrost for a selected length of time.

1. Press the MICROWAVE button.
2. Turn the selector dial to DEFROST-TIME. Press the dial to enter.
3. Turn the dial to select the time you want. Press the dial to enter.
4. Press the dial or START/PAUSE button to start defrosting.
5. Turn the food over when the oven signals TURN FOOD OVER.

Power level is automatically set at 3, but can be changed. To change the power levels, see the Microwave Power Level section. You can defrost small items quickly by raising the power level after entering the time. Power level 7 cuts the total defrosting time in about half; power level 10 cuts the total time to about 1/3. When defrosting at high power levels, food will need more frequent attention than usual.

Defrosting tips

Use DEFROST-AUTO for meat, poultry and fish. Use DEFROST-TIME for most other frozen foods.

- Foods frozen in paper or plastic can be time defrosted in the package, but foods should be taken out of the package when using DEFROST-AUTO. Closed packages should be slit, pierced or vented after food has partially defrosted. Plastic storage containers should be partially uncovered.
- Family-size, prepackaged frozen dinners can be defrosted and microwaved. If the food is in a foil container, transfer it to a microwave-safe dish
- Foods that spoil easily should not be allowed to sit out for more than one hour after defrosting. Room temperature promotes the growth of harmful bacteria.
- For more even defrosting of larger foods, such as roasts, use DEFROST-AUTO. Be sure large meats are completely defrosted before cooking
- When defrosted, food should be cool but softened in all areas. If still slightly icy, return to the microwave very briefly, or let it stand a few minutes

Microwave sensor cooking

The sensor feature detects the increasing humidity released during cooking. The oven automatically adjusts the cooking time to various types and amounts of food.

Do not use the Sensor Features twice in succession on the same food portion—it may result in severely overcooked or burnt food. If food is undercooked after the first countdown, use TIME COOK for additional cooking time.

The proper containers and covers are essential for best sensor cooking.

- Always use microwave-safe containers and cover them with lids or vented plastic wrap. Never use tight sealing plastic containers—they can prevent steam from escaping and cause food to overcook.
- Be sure the outside of the cooking containers and the inside of the oven are dry before placing food in the oven. Beads of moisture turning into steam can mislead the sensor.
- Beverages are best heated uncovered.



Covered



Vented



*Dry off dishes so they don't
mislead the sensor.*

MICROWAVE SENSOR PROGRAMS:

- Beverage
- Popcorn – Prepackaged microwave popcorn, 1.5 oz. to 3.5 oz.
- Reheat – Single servings (4 to 6 oz.) of leftovers.
- Soup

To use all sensor programs

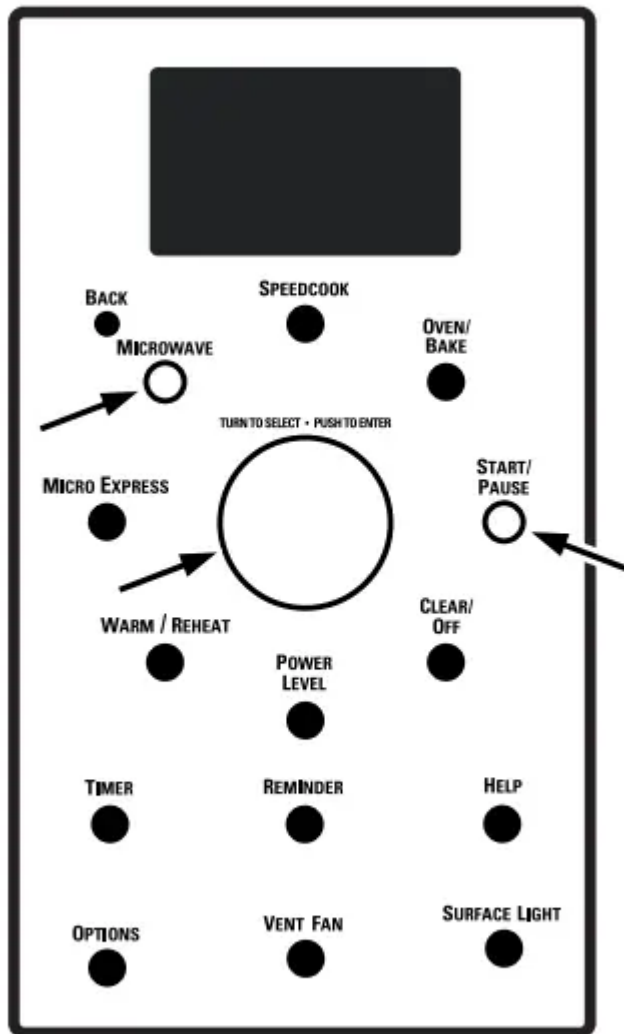

Advantium’s microwave mode features sensor cooking. The oven automatically senses when food is done and shuts itself off—eliminating the need to program cooktimes and power levels.

1. Press the MICROWAVE button.
2. Turn the dial to select the food you want. Press the dial to enter.
3. Press the dial or press the START/ PAUSE button to start cooking. Do not open the oven door until time is counting down in the display. If the door is opened, close it and press START/PAUSE immediately. If the food is not done enough, use TIME COOK in the microwave selector to cook for more time.

NOTE: Do not use the Sensor Features twice in succession on the same food portion—it may result in severely overcooked or burnt food.

- If you have been speedcooking or baking and the oven is already hot, it may indicate that it is too hot for sensor cooking. Of course, you can always continue with the non-sensor functions.

- To shorten or lengthen the cook time, wait until the time countdown shows in the display. Then turn the dial to add or subtract time.
- Drinks heated with the BEVERAGE feature may be very hot. Remove the container with care.
- If you open the door while sensor cooking, SENSOR ERROR will appear. Close the door, press START to begin again.

Notes about the Reheat program:

Reheated foods may have wide variations in temperature. Some areas may be extremely hot. For improved re

heating quality on crisper foods, use the TIMED REHEAT feature found by pressing WARM/REHEAT.

It is best to use TIME COOK and not REHEAT for these foods:

- Bread products
- Food that must be reheated uncovered.
- Foods that need to be stirred or turned.
- Foods calling for a dry look or crisp surface after reheating

Things that are normal

Interference

- TV/radio interference might be noticed while using the microwave. Similar to the interference caused by other small appliances, it does not indicate a problem with the microwave. Move the radio or TV as far away from the microwave as possible, or check the position of the TV/radio antenna.

Oven Heat

- Cookware may become hot because of heat transferred from the heated food. Oven mitts may be needed to handle the cookware
- Steam or vapor may escape from around the door.

Sounds

- You may hear a dull thumping sound while the oven is operating.

Other Advantium Features

“FOOD IS READY”

To remind you that you have food in the oven, the oven will display FOOD IS READY and beep once a minute until you either open the oven door or press the CLEAR/OFF button.

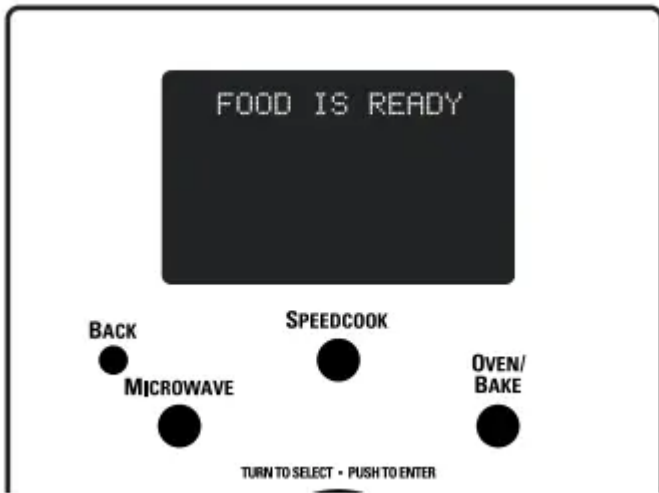

Features under the **OPTIONS** button



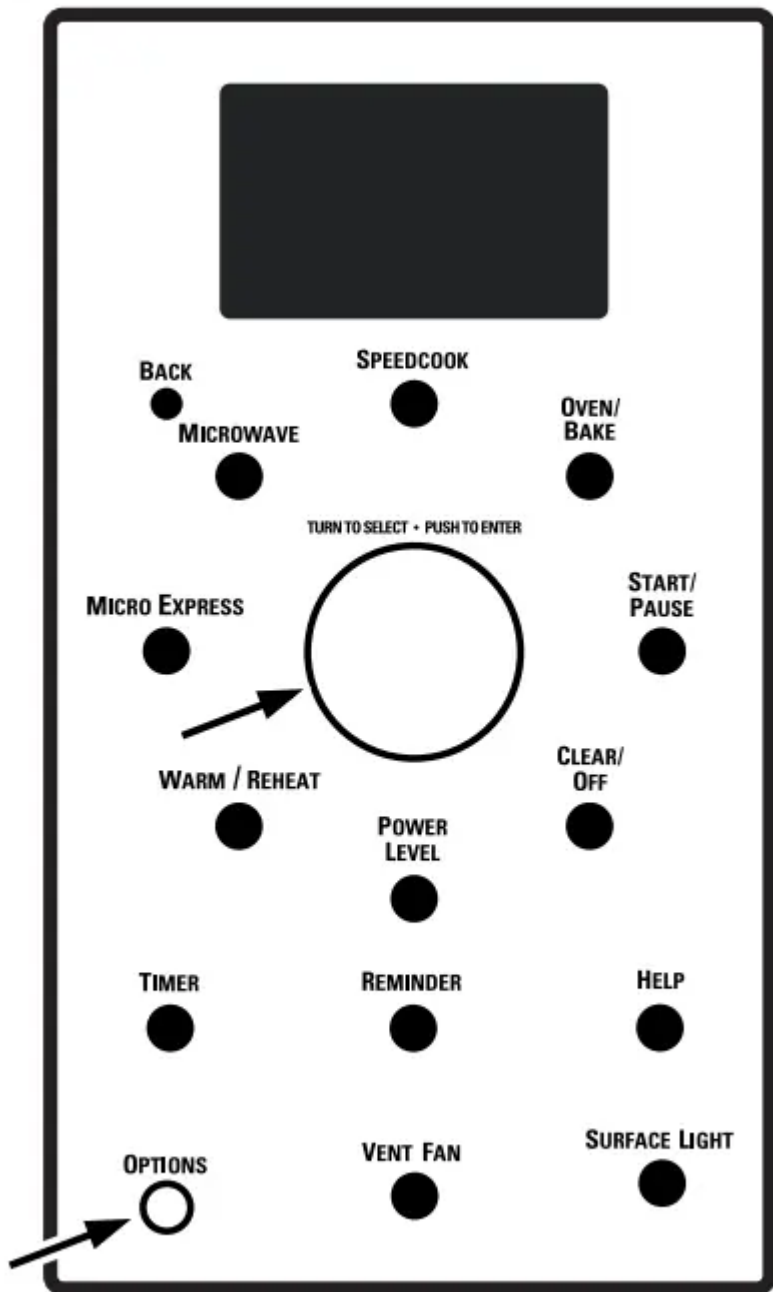

Clock:

The clock must be set before you can use your oven for the first time (see Quick Start for instructions).

1. To change the clock time, press the OPTIONS pad and turn the dial to CLOCK. Press the dial to enter.
2. Turn the dial to set hours. Press the dial to enter.
3. Turn the dial to set minutes. Press the dial to enter.
4. Turn the dial to select AM or PM. Press the dial to enter.

Clock Display ON/OFF:

Use this feature to turn your clock display on or off. Press the OPTIONS button, turn the dial to select CLOCK DISPLAY. Turn the dial to select ON or OFF. Press the dial to enter.

Auto Night Light:

Use this feature to program the onoff time for an automatic night light. Press the OPTIONS button, turn the dial to select NIGHT LIGHT, press the dial to enter and follow the display directions.

Beeper Volume:

Use this feature to adjust the volume of the beeper. You can even turn it off. Press the OPTIONS button, turn the dial to select BEEPER VOLUME, press the dial to enter and follow the display directions.

Scroll Speed:

Is the message scroll too slow or too fast? Change it! Press the OPTIONS button, turn the dial to select DISPLAY SPEED, press the dial to enter, and follow the display directions.

Delayed Start:

Delayed Start allows you to set the oven to delay cooking up to 24 hours. Press the OPTIONS button, turn the dial to select DELAYED START and press the dial to enter. Follow the display directions to set the Delayed Start time and feature you wish to delay

Review

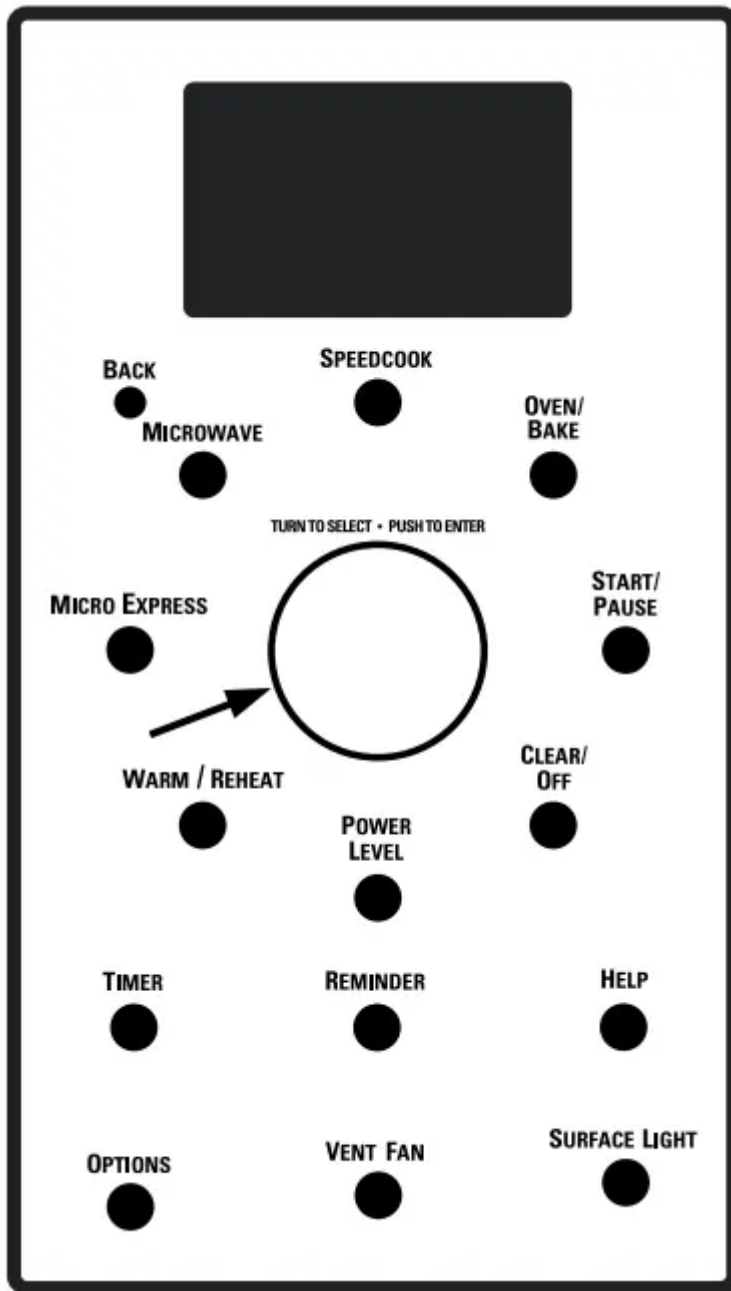

Use this feature to review the current cooking selections you have set.

Press the selector dial at any time during cooking.

Help

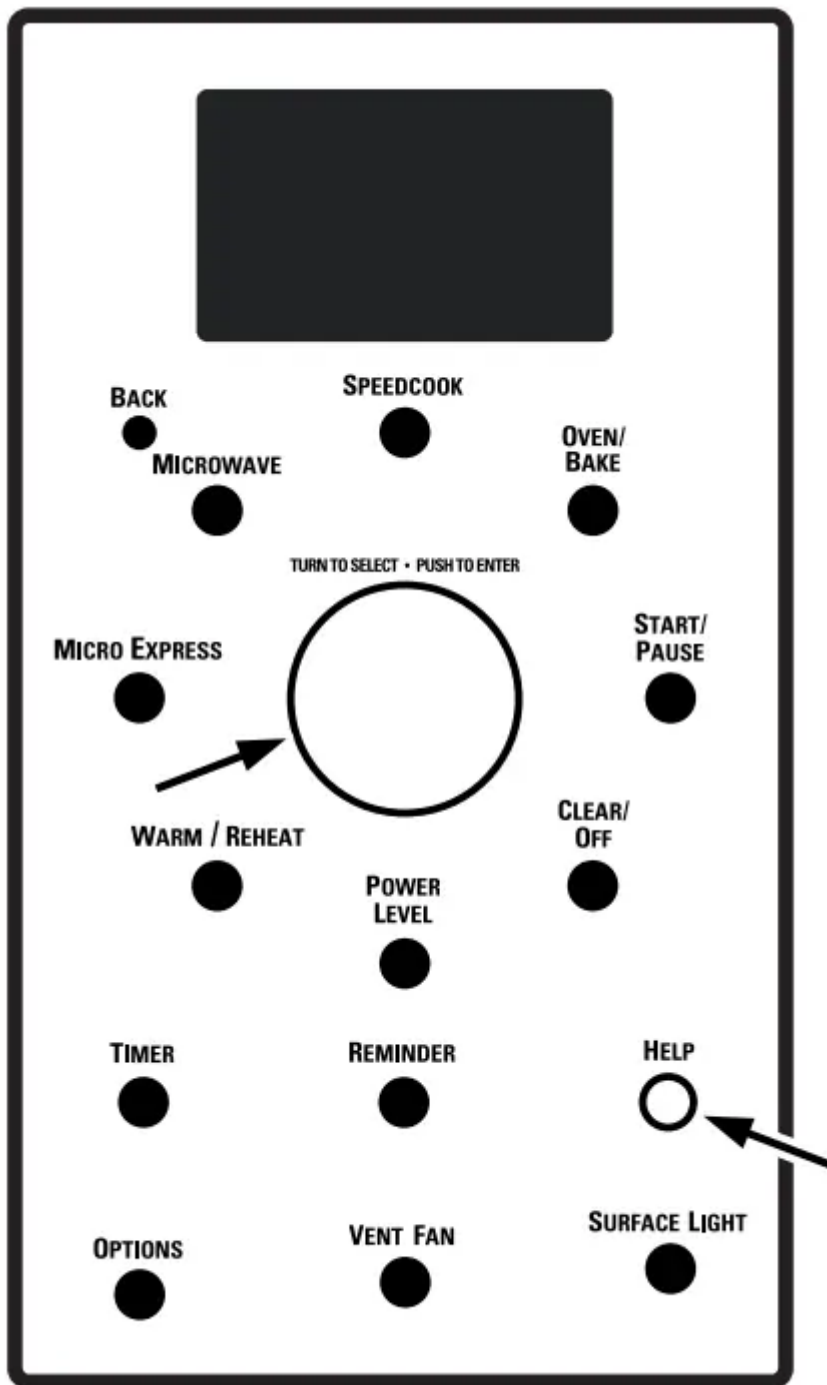

Use this feature to find out more about your oven and its features.

1. Press the HELP button.
2. Turn the dial to select the feature name. Press the dial to enter.

The display will show a description for the program you have chosen.

Child lockout

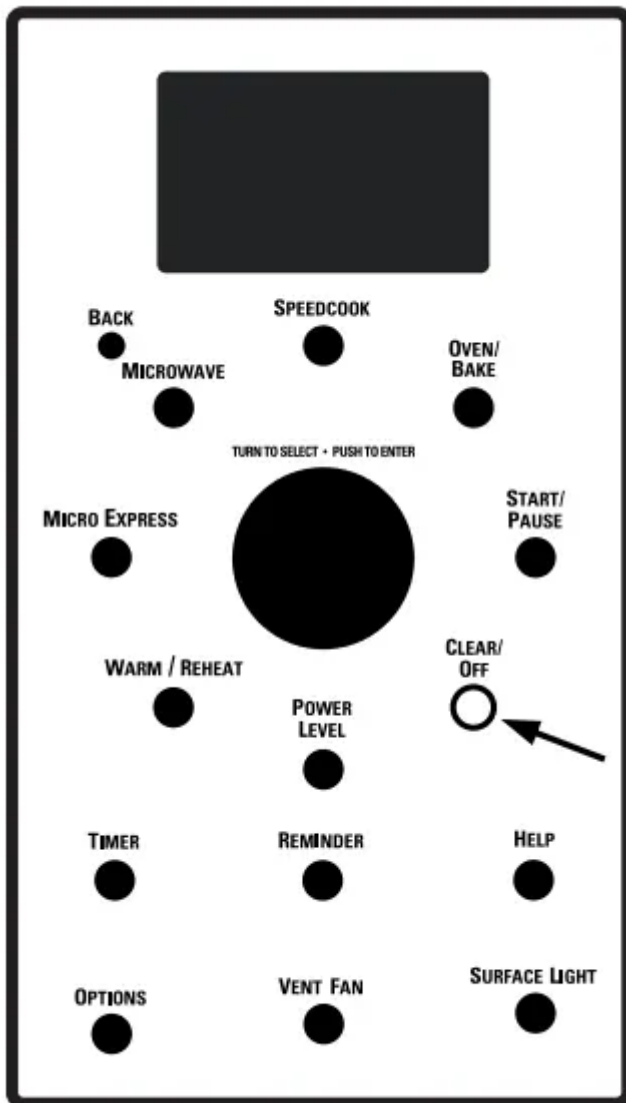

You may lock the control panel to prevent the oven from being accidentally started or used by children.

Press and hold CLEAR/OFF for about 3 seconds to lock and unlock

When the control panel is locked, Control Panel LOCKED will be displayed briefly anytime a button or dial is pressed.

Surface light

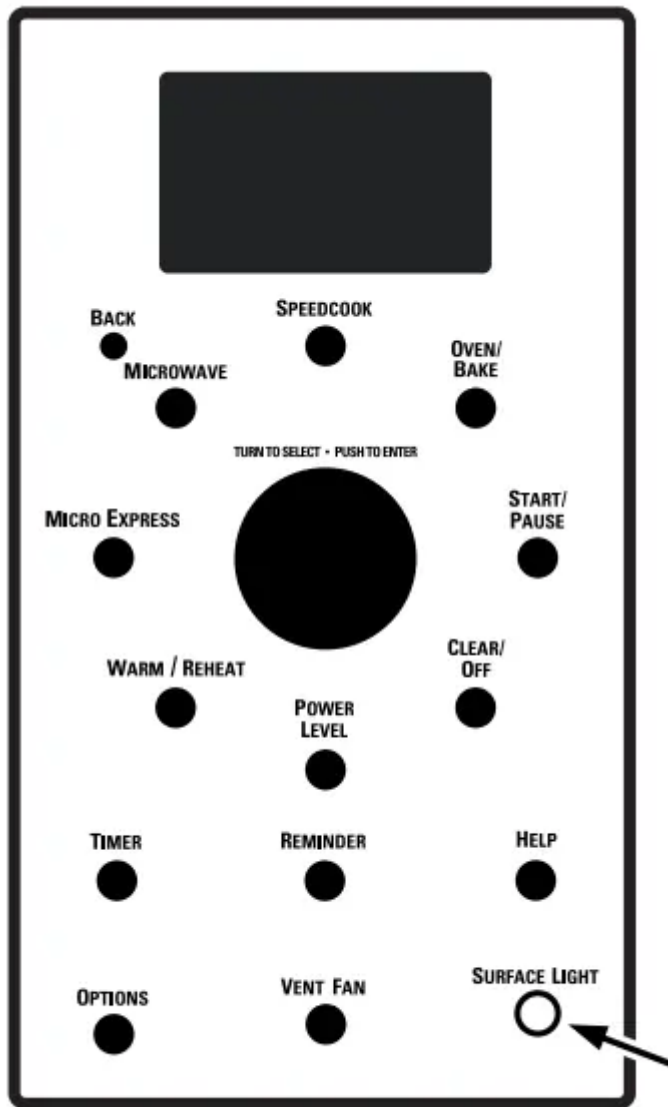

Use to light your cooktop.

Press the SURFACE LIGHT button to select the proper setting.

Continue pressing to change from bright to nightlight to off.

Vent fan

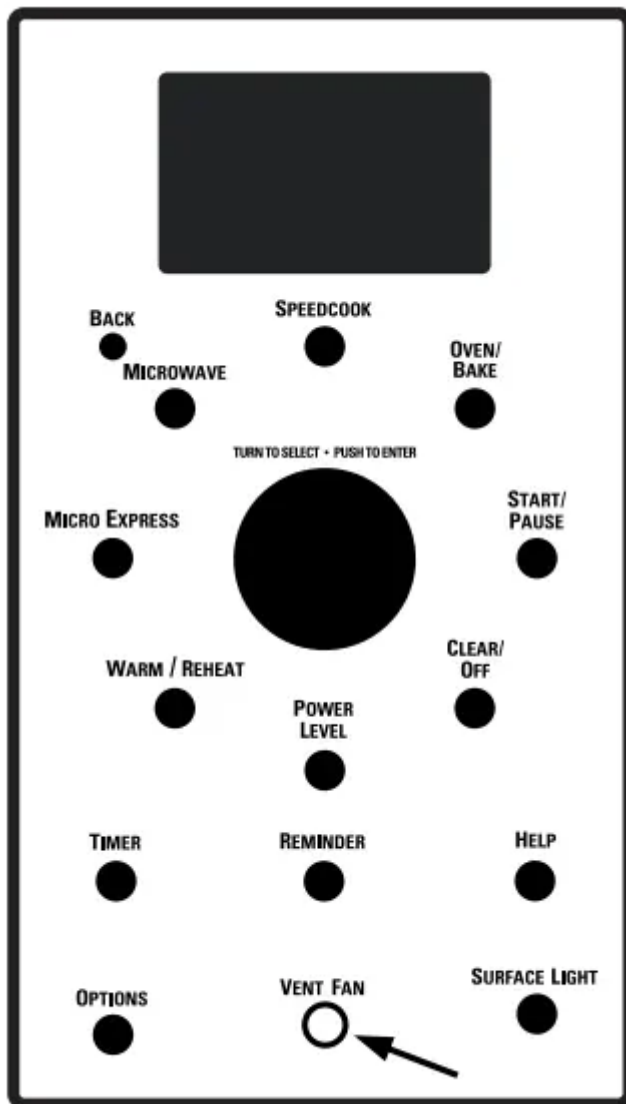

The vent fan removes steam and other vapors from surface cooking.

Press the VENT FAN button to select the fan speed.

Continue pressing to change from high to low to off.

Timer

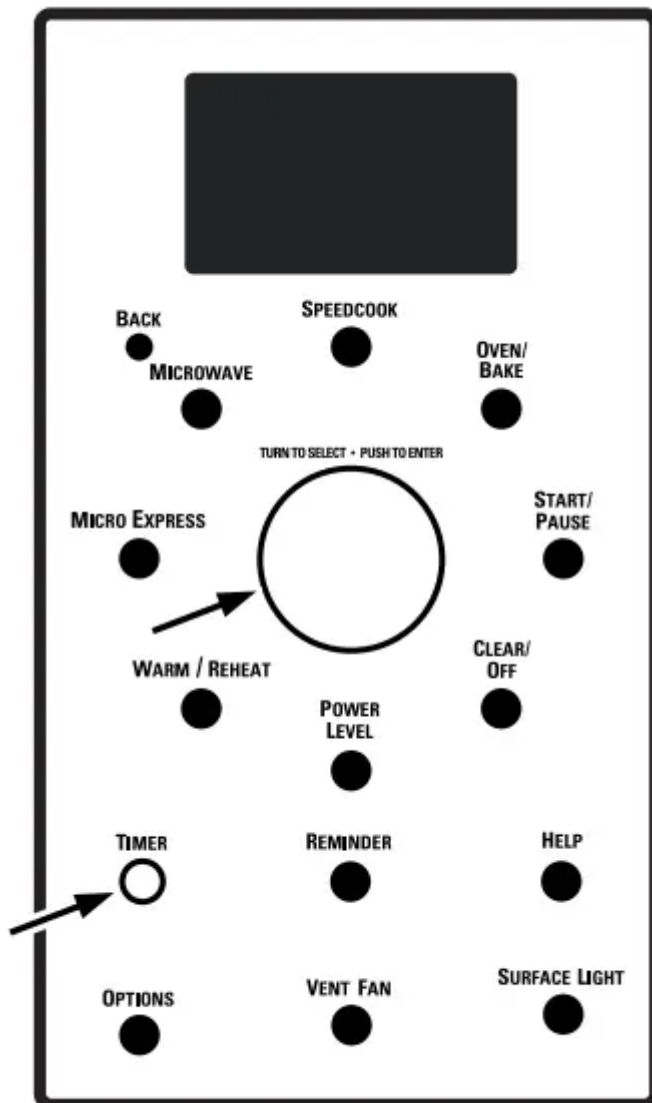

Use this feature anytime you need a general purpose timer. It can even be used while cooking in the oven.

1. Press the TIMER button.
2. Turn the dial to select the minutes. Press the dial to enter.
3. Turn the dial to select the seconds. Press the dial to enter.

To pause, press TIMER. To restart, press TIMER again.

To cancel, press and hold the TIMER button down for about 3 seconds.

Reminder

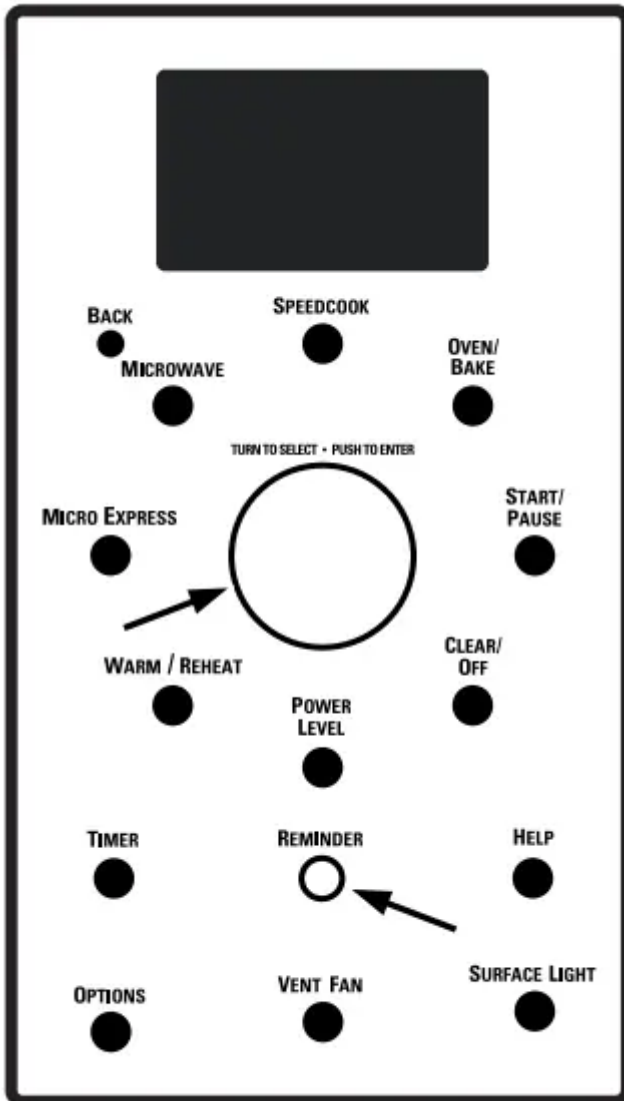

Use this feature like an alarm clock to help you keep up with things to do.

1. Press the REMINDER button and select reminder time. Follow the directions in the display:

A. Turn the dial to set hours. Press the dial to enter.

B. Turn the dial to set minutes. Press the dial to enter.

C. Turn the dial to select AM or PM. Press the dial to enter

To briefly display the reminder time, press the REMINDER button.

To cancel, press and hold the REMINDER button for about 3 seconds.

Automatic fan

An automatic fan feature protects the oven from too much heat rising from the cooktop below it and from too much heat inside the oven cavity.

It automatically turns on at low speed if it senses too much heat.

If you have turned the fan on you may find that you cannot turn it off. The fan will automatically turn off when the internal parts are cool. It may stay on for 30 minutes or more after the cooktop and oven controls are turned off.

Care and Cleaning

Helpful hints

An occasional thorough wiping with a solution of baking soda and water keeps the inside fresh.

Be certain the oven control is turned off before cleaning any part of this oven.



Walls, Floor, Inside Win

Some spatters can be removed with a paper towel, others may require a damp soapy cloth.

Remove greasy spatters with a damp sudsy cloth, then rinse with a damp cloth.

Do not spray or splash liquids directly into the heater areas. Do not use abrasive cleaners or sharp utensils on oven walls.

Never use a commercial oven cleaner on any part of your oven.

Do not clean the inside of the oven with metal scouring pads. Pieces can break off the pad, causing electrical shock.

Some food or liquids may fall into the heater areas. The heaters will cook most of the food away. Any remaining residue will not affect cooking.

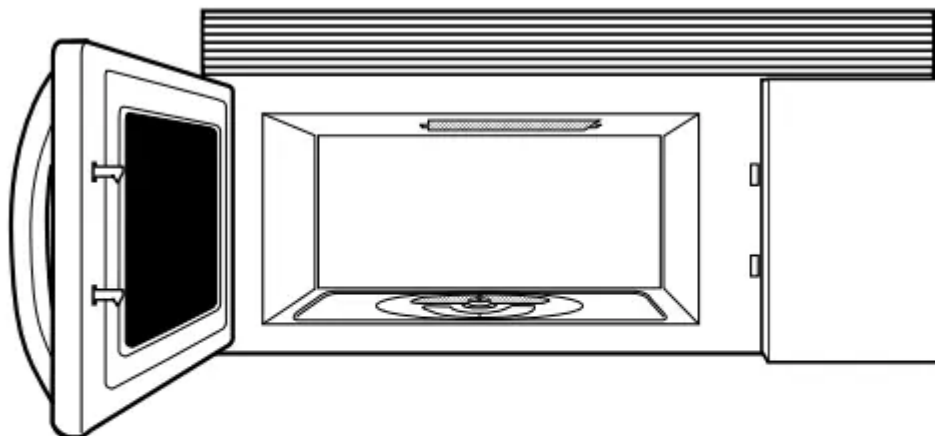

*Walls, Floor, Inside Window, Metal
and Plastic Parts on the Door*

Removable oven racks (turntable)

The area underneath the oven rack (turntable) should be cleaned frequently to avoid odors and smoking during a cooking cycle.

The oven rack (turntable) can be broken if dropped. Wash carefully in warm, sudsy water. Dry completely and replace.

To replace the oven rack (turntable), place its center over the hub in the center of the oven and turn it until it seats into place.

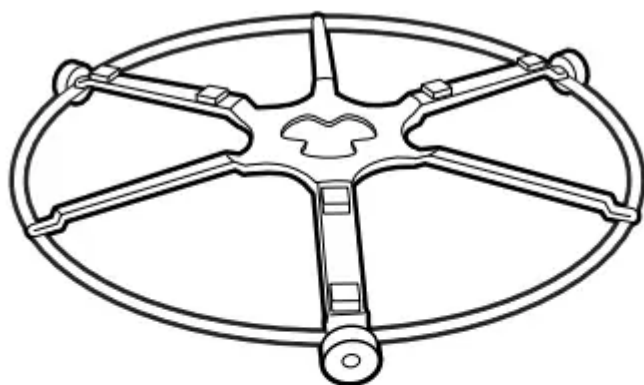

Oven Rack (Turntable)

*Do not use the oven without the
oven rack (turntable) in place.*

Baking sheets (cooking trays)

To prevent breakage, allow the trays to cool completely before cleaning. Wash carefully in warm, sudsy water or in the dishwasher.

A soap-filled scouring pad can also be used to clean the black metal tray. Do not use abrasives, as they may damage the finish.

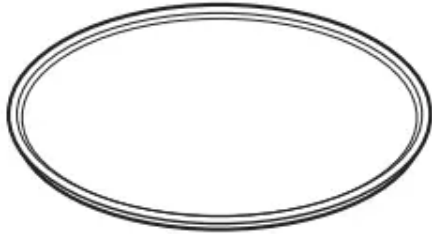

Glass microwave tray

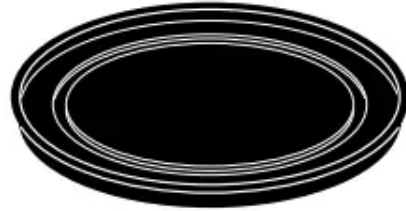

Black metal tray

How to clean the outside

We recommend against using cleaners with ammonia or alcohol, as they can damage the appearance of the microwave oven. If you choose to use a common household cleaner, first apply the cleaner directly to a clean cloth, then wipe the soiled area.

Case

Clean the outside of the microwave with a sudsy cloth. Rinse and then dry. Wipe the window clean with a damp cloth.

Control Panel

Wipe with a damp cloth. Dry thoroughly. Do not use cleaning sprays, large amounts of soap and water, abrasives or sharp objects on the panel—they can damage it. Some paper towels can also scratch the control panel.

Door Panel

Before cleaning the front door panel, make sure you know what type of panel you have. Refer to the eighth digit of the model number. “S” is stainless steel, “L” is CleanSteel and “B”, “W” or “C” are plastic colors.

Stainless Steel

The stainless steel panel can be cleaned with Stainless Steel Magic or a similar product using a clean, soft cloth. Apply stainless cleaner carefully to avoid the surrounding plastic parts. Do not use appliance wax, polish, bleach or products containing chlorine on Stainless Steel finishes.

CleanSteel

Use a clean, soft, light and lightly dampened cloth, then dry thoroughly. Do not use appliance wax, polish, bleach or products containing any chemical agent on the CleanSteel surfaces.

Plastic Color Panels

Use a clean, soft, lightly dampened cloth, then dry thoroughly.

Door Seal

It's important to keep the area clean where the door seals against the microwave. Use only mild, non-abrasive detergents applied with a clean sponge or soft cloth. Rinse well.

Bottom

Clean off the grease and dust on the bottom often. Use a solution of warm water and detergent.

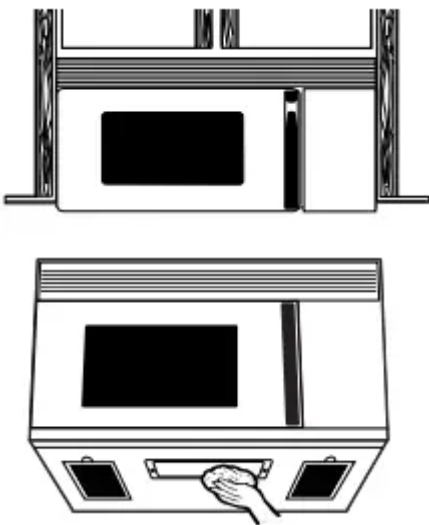

The vent fan

The vent fan has 2 metal reusable vent filters.

Ovens configured to recirculate air back into the room should also use a charcoal filter.

Charcoal Filter (on some models)

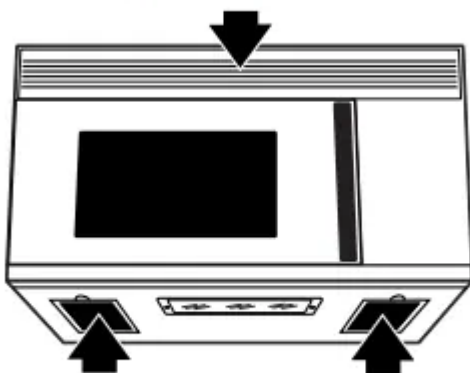

Reusable Vent Filters (on all models)

Cooktop light/ night light

1. To replace the cooktop light/ night light, first disconnect the power at the main fuse or circuit breaker panel. u
2. Remove the screw from the side of the light compartment cover and lower the cover until it stops.
3. Be sure the bulb to be replaced is cool before removing. Gently pull the bulb from the receptacle.

Replace with a 12 volt, 20-watt halogen bulb. Order WB36X10176 from your GE supplier.

4. Raise the light cover and replace the screw. Connect electrical power to the oven.

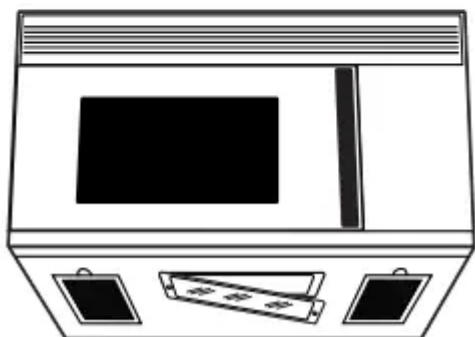
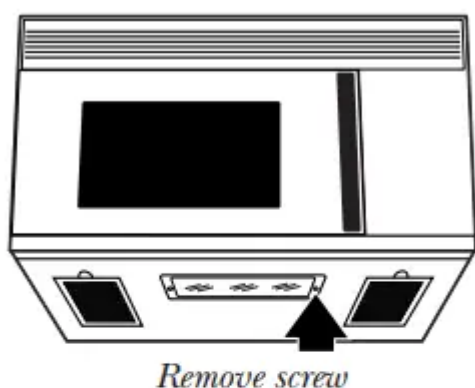

Reusable vent filters

The metal filters trap grease released by foods on the cooktop. They also prevent flames from foods on the cooktop from damaging the inside of the oven.

For this reason, the filters must always be in place when the hood is used. The vent filters should be cleaned once a month, or as needed

Removing and cleaning the filters

To remove, slide them to the rear using the tabs. Pull down and out. To clean the vent filters, soak them and then swish around in hot water and detergent. Don't use ammonia or ammonia products because they will darken the metal. Light brushing can be used to remove embedded dirt.

Rinse, shake and let dry before replacing.

To replace, slide the filters into the frame slots on the back of each opening. Press up and to the front to lock into place.

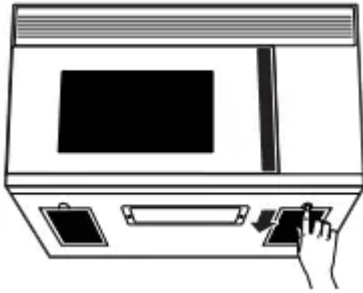

Charcoal filter (JX81A)

The charcoal filter cannot be cleaned. It must be replaced. Order Part No. WB2X9883 from your GE supplier. If the model is not vented to the outside, the air will be recirculated through a disposable charcoal filter that helps remove smoke and odors.

The charcoal filter should be replaced when it is noticeably dirty or discolored (usually after 6 to 12 months, depending on usage).

To remove the charcoal filter

To remove the charcoal filter, first disconnect power at the main fuse.

Remove the top grille by removing the 2 screws that hold it in place.

You may need to open the cabinet doors to remove the screws.

Slide the filter towards the front of the oven and remove it.

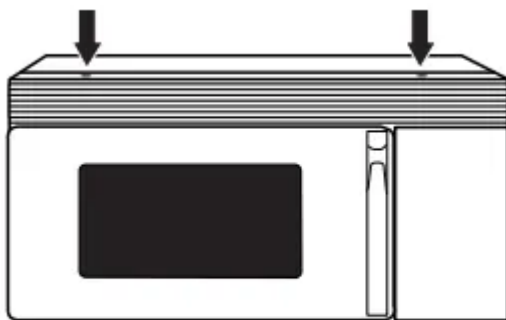

*Remove 2 grille screws to
remove the grille.*

To install the charcoal filter

To install a new filter, remove plastic and other outer wrapping from the new filter.

Insert the filter into the top opening of the oven as shown maneuvering it behind the plastic grille until it fits squarely into place.

It will rest at an angle behind the plastic grille on two side support tabs and in front of the right rear tab. Replace the grille and 2 screws. Reconnect power at the main fuse.

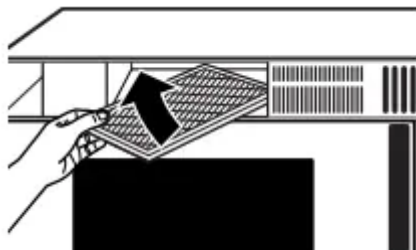

Optional kits

Available at extra cost from your GE supplier

- Filler Panel Kits
- JX40WH—White

JX41—Black When replacing a 36" range hood, filler panel kits fill in the additional width to provide a custom built-in appearance.

For installation between cabinets only; not for end-of-cabinet installation. Each kit contains two 3" wide filler panels.

Filter Kits

- JX81A—Recirculating Charcoal Filter Kit

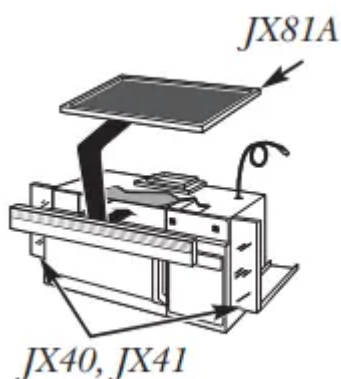

Filter kits are used when the oven cannot be vented to the outside.

Troubleshooting



Problem	Possible Causes	What To Do/Explanation
LIGHTS		
Light during a speedcook cycle dims and cycles on and off, even at full power levels	This is normal. Power level has been automatically reduced because the oven is hot.	<ul style="list-style-type: none"> • This is normal. The oven senses the heat level and adjusts automatically.
Light visible around the door and outer case while speedcooking	This is normal	<ul style="list-style-type: none"> • When the oven is on, light may be visible around the door and outer case.
FAN		
Fan continues to run after cooking stops	The oven is cooling.	<ul style="list-style-type: none"> • The fan will automatically shut off when the internal parts of the oven have cooled.
Oven vent emits warm air while oven is on	This is normal	
Fan comes on automatically when oven not in use	This is normal	<ul style="list-style-type: none"> • If the cooktop gets too hot, the vent fan comes on.
Fan comes on automatically when using the microwave	This is normal	<ul style="list-style-type: none"> • If the microwave is used after speedcook and the oven senses that it is too hot, the vent fan comes on to cool the oven.
COOKING		
The oven makes unusual sounds while cooking	Clicks and fans blowing components on and off.	<ul style="list-style-type: none"> • These sounds are normal.
Smoke comes out of the oven when I open the door	Food is high in fat Content Aerosol spray used on the pans.	<ul style="list-style-type: none"> • Smoke is normal when cooking fat foods. Use vegetable oil or olive on the meat itself instead of coating the entire pan. # Increase or decrease

		time for doneness or adjust the upper or lower lamps for browning.
Food is not fully cooked or browned at the end of a cooking program	Programmed times may not match the size or amount of food you are cooking.	<ul style="list-style-type: none"> • Increase or decrease time for doneness or adjust the upper or lower lamps for browning.

Questions? Use this problem solver



Problem	Possible Causes	What To Do/Explanation
DISPLAY		
The display is blank	The clock display has been turned off.	<ul style="list-style-type: none"> • Check the OPTIONS menu for clock display settings. Turn the display on.
“Control Panel LOCKED” appears in display	The control has been locked.	<ul style="list-style-type: none"> • Press and hold CLEAR/OFF for about 3 seconds to unlock the control
Control display is lighted yet oven will not start	Clock is not set.	<ul style="list-style-type: none"> • Set the clock.
	Door not securely closed	<ul style="list-style-type: none"> • Open the door and close securely
	START/PAUSE button. not pressed after entering i cooking selection.	<ul style="list-style-type: none"> • Press START/PAUSE.
	Another selection already entered in oven and CLEAR/OFF button not pressed to cancel it	<ul style="list-style-type: none"> • Press CLEAR/OFF.
	Size, quantity, or cooking time not entered after selecting VEGETABLES (FRESH, FROZEN, CANNED), BACON, DEFROST-TIME TIME COOK	<ul style="list-style-type: none"> • Make sure you have entered cooking time after selecting
	CLEAR/OFF was pressed accidentally	<ul style="list-style-type: none"> • Reset cooking program and press START/PAUSE.
	Food weight not entered after selecting DEFROST-AUTO.	<ul style="list-style-type: none"> • Make sure you have entered food weight

		after selecting DEFROST- AUTO.
OTHER PROBLEMS		•
The door and inside of the oven feels hot		<ul style="list-style-type: none"> • This is normal • Use oven mitts to remove food when when ready.
Floor of the oven is warm, even when the oven has not been used	The cooktop light is located below the oven floor. When the light is on the heat it produces may make the oven floor get warm.	<ul style="list-style-type: none"> • This is normal.
Oven will not start	A fuse in your home may be bore or the circuit breaker tripped.	<ul style="list-style-type: none"> • Replace fuse or reset circuit breaker.
	Power surge	<ul style="list-style-type: none"> • Unplug the oven, then plug it back in.
	Plug not fully inserted into wall outlet.	<ul style="list-style-type: none"> • Make sure the plug on the oven is fully inserted into wall outlet.
Glass microwave tray does not lock into center hub.		<ul style="list-style-type: none"> • This is normal. Center the tray on the oven rack (turntable)

Warning

This content is compiled from multiple sources and is provided for reference purposes only. It may not be complete or fully applicable to all situations. If you are unable to resolve your issue, please contact the product manufacturer or an authorized service provider for official support.