

Maintenance

Cleaning

Clean the microwave oven regularly to prevent impurities from building up on or inside the microwave oven. Also pay special attention to the door, door sealing, and turntable and roller ring (applicable models only).

If the door won't open or close smoothly, first check if the door seals have built up impurities. Use a soft cloth in soapy water to clean both the inner and outer sides of the microwave oven. Rinse and dry well.

To remove stubborn impurities with bad smells from inside the microwave oven

1. With an empty microwave oven, put a cup of diluted lemon juice on the centre of the turntable.
2. Heat the microwave oven for 10 minutes at max power.
3. When the cycle is complete, wait until the microwave oven cools down. Then, open the door and clean the cooking chamber.

CAUTION

- Keep the door and door sealing clean and ensure the door opens and closes smoothly. Otherwise, the microwave oven's lifecycle may be shortened.
- Take caution not to spill water into the microwave oven vents.
- Do not use any abrasive or chemical substances for cleaning.
- After each use of the microwave oven, use a mild detergent to clean the cooking chamber after waiting for the microwave oven to cool down.

Microwave oven features

Microwave oven

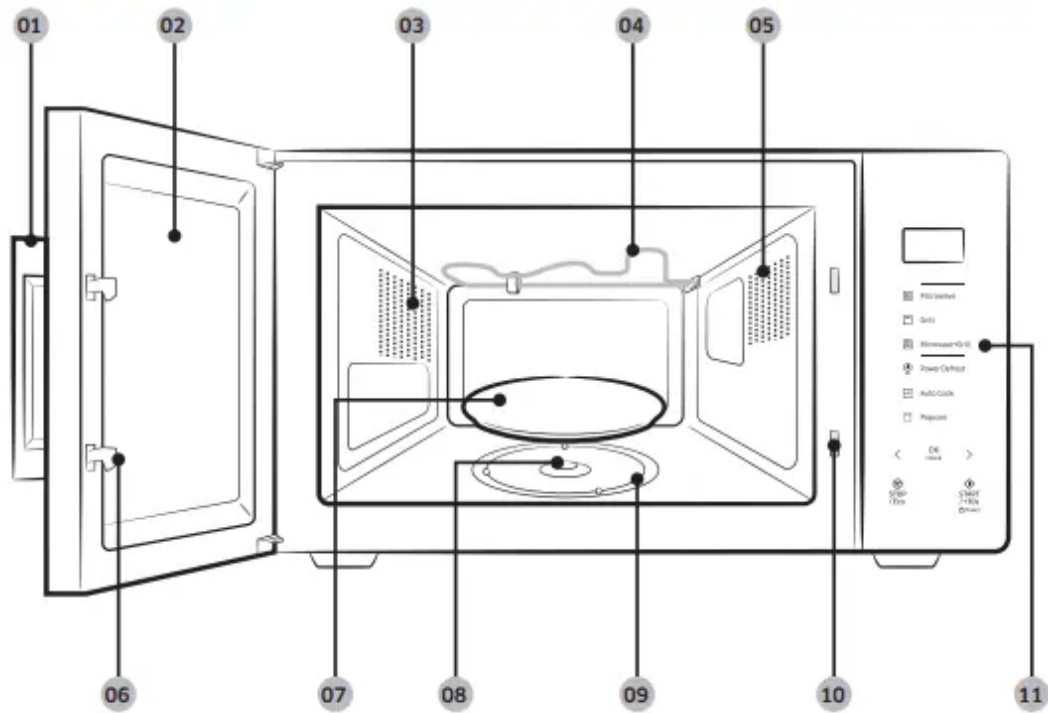

-
- | | | |
|----------------------------------|-------------------------|-----------------------------|
| 01 Door handle | 02 Door | 03 Ventilation holes |
| 04 Heating element | 05 Light | 06 Door latches |
| 07 Turntable | 08 Coupler | 09 Roller ring |
| 10 Safety interlock holes | 11 Control panel | |



- 01 Display
- 02 Microwave
- 03 Grill
- 04 Microwave+Grill
- 05 Power Defrost
- 06 Auto Cook
- 07 Popcorn
- 08 Decrease/Increase (Weight/Serving/Time)
- 09 OK (Clock)
- 10 STOP/Eco
- 11 START/+30s (Child Lock)



Microwave oven use

How a microwave oven works

Microwaves are high-frequency electromagnetic waves; the energy released enables food to be cooked or reheated without changing either the form or the colour.

You can use your microwave oven to:

- Defrost
- Reheat
- Cook

Cooking principle

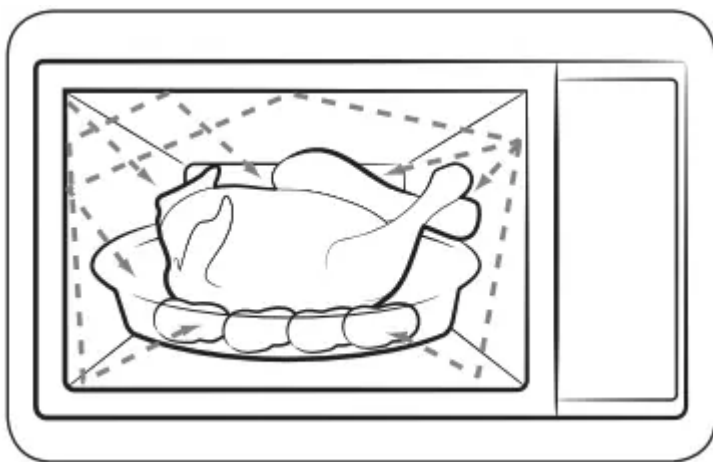

1. The microwaves generated by the magnetron reflected at cavity and are distributed uniformly as the food rotates on the turntable. The food is thus cooked evenly.
2. The microwaves are absorbed by the food up to a depth of about 1 inch (2.5 cm). Cooking then continues as the heat is dissipated within the food.
3. Cooking times vary according to the container used and the properties of the food:
 - Quantity and density
 - Water content
 - Initial temperature (refrigerated or not)

NOTE

As the centre of the food is cooked by heat dissipation, cooking continues even when you have taken the food out of the microwave oven. Standing times specified in recipes and in this booklet must therefore be respected to ensure:

- Even cooking of the food right to the centre.
- The same temperature throughout the food.

Checking that your microwave oven is operating correctly

The following simple procedure enables you to check that your microwave oven is working correctly at all times.

If you have any problems, see the “Troubleshooting” section on pages 40 to 44.

NOTE The microwave oven must be plugged into an appropriate wall socket. The turntable must be placed in the microwave oven. If a power level other than the maximum (100 % - 1000 W) is used, the water takes longer to boil.

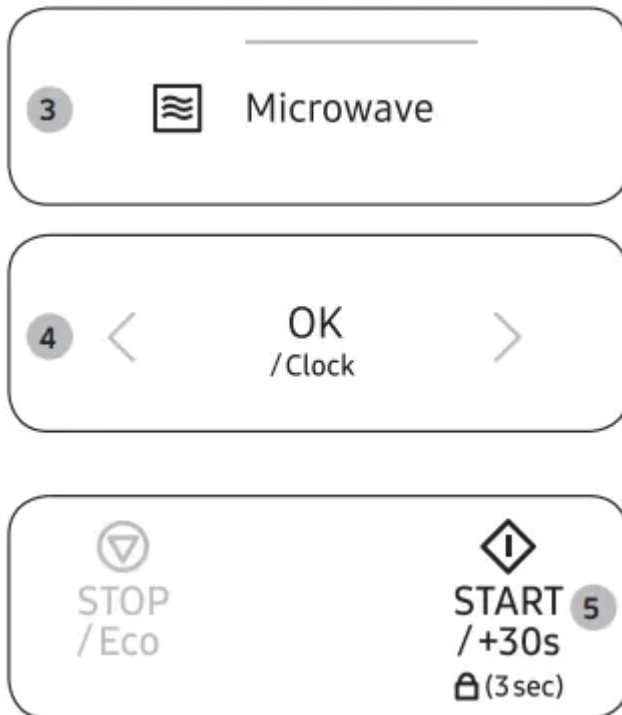

1. Pull the handle to open the microwave oven door.
2. Place a glass of water on the turntable, and then close the door.
3. Press Microwave.
4. The control panel display shows the corresponding power level (100 - 1000 W). Press the OK button for desired power level.
5. Press START/+30s repeatedly to set the time to 4 or 5 minutes.
6. The microwave oven heats the water for the set time. Check and make sure the water is boiling.

Cooking/Reheating

The following procedure explains how to cook or reheat food.

CAUTION Always check your cooking settings before leaving the microwave oven unattended.



1. Pull the handle to open the microwave oven door.
2. Place the food on the centre of the turntable, and then close the door.

CAUTION Do not operate the microwave oven when it is empty.

3. Press Microwave.

- The control panel display shows the corresponding icon () and the maximum power level (1000 W).



4. Press < or > (Decrease/Increase) to select the desired power level, and then press OK.
- Refer to the “Power levels and time variations” section on page 16 for the appropriate power level.



5. Press < or > (Decrease/Increase) to set the desired cooking time.
- The control panel display shows the cooking time.
6. Press START/+30s to start cooking.
- The light turns on and the turntable starts to rotate.

- When the cooking is complete, the microwave oven beeps 4 times and the control panel display shows the current time. Then, the end reminder signal beeps once every minute for 3 times.

Setting the time

When power is supplied, “88:88” and then “12:00” is automatically displayed on the display. Please set the current time.

- When you first install your microwave oven
- After a power failure

NOTE You must manually change the time to apply daylight saving time.

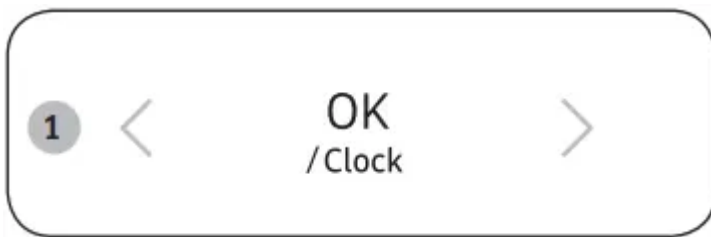

1. Press OK.



2. Press < or > (Decrease/Increase) to set the hour, and then press OK.

3. Press < or > (Decrease/Increase) to set the minute, and then press OK.

NOTE The control panel display shows the time when the microwave is not in use.

Power levels and time variations

The power level function enables you to adapt the amount of energy dissipated and thus the time required to cook or reheat your food, according to its type and quantity. You can choose between 11 power levels.

| | | | |
|------------|-----------------|-------------|---------------|
| 0 = PL:0 | (Deodorization) | 60 = PL:60 | (Simmer) |
| 10 = PL:10 | (Warm) | 70 = PL:70 | (Medium high) |
| 20 = PL:20 | (Defrost) | 80 = PL:80 | (Reheat) |
| 30 = PL:30 | (Low) | 90 = PL:90 | (Sauté) |
| 40 = PL:40 | (Medium low) | 100 = PL:Hi | (High) |
| 50 = PL:50 | (Medium) | | |

The cooking times given in recipes and in this booklet correspond to the specific power level indicated.

- The cooking time decreases If you select a higher power level.
- The cooking time increases If you select a lower power level.

Adjusting the cooking time

You can increase or decrease the cooking time while the microwave oven is cooking.

- Check how cooking is progressing at any time simply by opening the door, and then increase or decrease the cooking time if necessary.



Method 1

Press START/+30s to increase the cooking time by 30 seconds.

- Example: To add three minutes, press START/+30s six times.

NOTE You can only increase the cooking time.

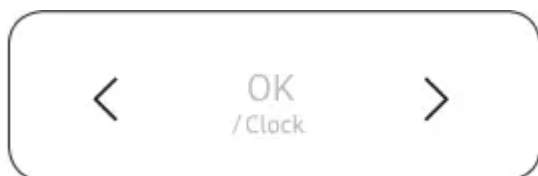

Method 2

Press < or > (Decrease/Increase) to adjust the cooking time.

Stopping the cooking

You can stop cooking at any time so that you can:

- Check the food
- Turn the food over or stir it
- Leave it to stand

To stop the cooking temporarily

1. Open the door or press STOP/Eco once.
 - Cooking stops temporarily.
2. To resume cooking, close the door and press START/+30s.

To stop the cooking completely

1. Open the door or press STOP/Eco once.
 - Cooking stops temporarily.
2. Press STOP/Eco button again.

Setting the energy save mode

The microwave oven has an energy save mode.



- Press STOP/Eco. The control panel display turns off.
- To cancel the energy save mode, open the door or press STOP/Eco. The control panel display shows the current time.

NOTE

Auto energy saving function

The product returns to standby status if there is no input for 25 minutes in the middle of setting or while the operation has been paused. Also, if you leave the door open, the interior lamp automatically turns off after 5 minutes.

Using Power Defrost

The defrost time and power level are set automatically. You simply select the programme and the weight.

CAUTION Use only containers that are microwave-safe.



1. Pull the handle to open the microwave oven door.
2. Place the food on the centre of the turntable, and then close the door.
3. Press Power Defrost.

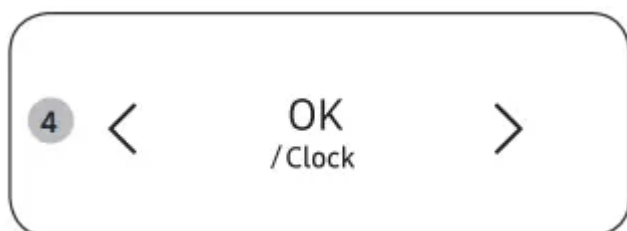

4. Press < or > (Decrease/Increase) to set the serving size (0.1 lb.-3.5 lbs.), and then press OK.



5. Press START/+30s to start defrosting.
 - When the microwave oven beeps, open the door and turn the food over.
6. Close the door, and then press START/+30s to resume defrosting.
 - When the defrosting is complete, the microwave oven beeps 4 times and the control panel display shows the current time. Then, the end reminder signal beeps once every minute for 3 times.

Using Auto Cook

Auto Cook has 37 pre-programmed cook settings. You do not need to set either the cooking times or the power level.

CAUTION Use only containers that are microwave-safe.



1. Pull the handle to open the microwave oven door.
2. Place the food on the centre of the turntable, and then close the door.
3. Press Auto Cook.



4. Press < or > (Decrease/Increase) to select the desired category, and then press OK.

- 1. Grill auto cook
- 2. Home Dessert
- 3. Auto Cook
- 4. Soften / melt

5. Press < or > (Decrease/Increase) to select the type of food, and then press OK.

- For more information, see the "Auto Cook programme description" section on pages 21 to 27.



6. Press < or > (Decrease/Increase) to select the serving size, and then press OK.

- For more information, see the "Auto Cook programme description" section on pages 21 to 27.
- Depending on the selected menu, you may have only one weight option available to select.
- You do not have to select a weight for Home Dessert.



7. Press START/+30s to start Auto Cook.

- The microwave oven cooks the food according to the selected preprogrammed setting.
- When the cooking is complete, the microwave oven beeps 4 times and the control panel display shows the current time. Then, the end reminder signal beeps once every minute for 3 times.

Grilling

The grill enables you to heat and brown food quickly, without using microwaves.

- Always use oven gloves when touching the cookware in the microwave oven, as they will be very hot.
- You can get better cooking and grilling results, if you use the grill rack.

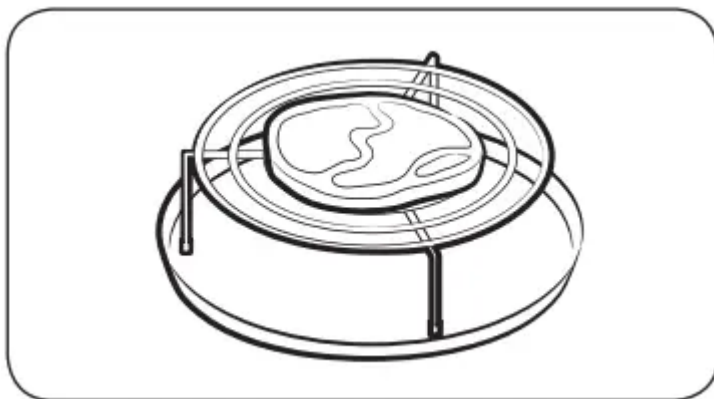

1. Pull the handle to open the microwave oven door.
2. Place the food on the grill rack, and then close the door.



3. Press Grill.

- The control panel display shows the corresponding icon ().
- You cannot set the temperature of the grill.



4. Press < or > (Decrease/Increase) to set the desired grilling time.
 - The maximum grilling time is 60 minutes.
5. Press START/+30s to start grilling.
 - When the grilling is complete, the microwave oven beeps 4 times and the control panel display shows the current time. Then, the end reminder signal beeps once every minute for 3 times.

Combining microwaves and grill

You can also combine microwave cooking with the grill, to cook quickly and brown at the same time.

CAUTION

- Always use microwave-safe and oven-proof cookware. Glass or ceramic dishes are ideal as they allow the microwaves to penetrate the food evenly.
- Always use oven gloves when touching the cookware in the microwave oven, as they will be very hot.
- You can improve cooking and grilling, if you use the grill rack.



1. Pull the handle to open the microwave oven door.

2. Place the food on the grill rack, and then close the door.
3. Press Microwave+Grill. • The control panel display shows the corresponding icon (🌀, 🍷).



4. Press < or > (Decrease/Increase) to set the desired cooking time.
 - The maximum cooking time is 60 minutes.
5. Press START/+30s to start cooking.
 - When the cooking is complete, the microwave oven beeps 4 times and the control panel display shows the current time. Then, the end reminder signal beeps once every minute for 3 times.

Using the crusty plate

This crusty plate allows you to brown food not only on the top with the grill, but also the bottom of the food turns crispy and brown due to the high temperature of the crusty plate. Several items which you can prepare on the crusty plate can be found in the chart (see next page). The crusty plate can also be used for bacon, eggs, sausages, etc.

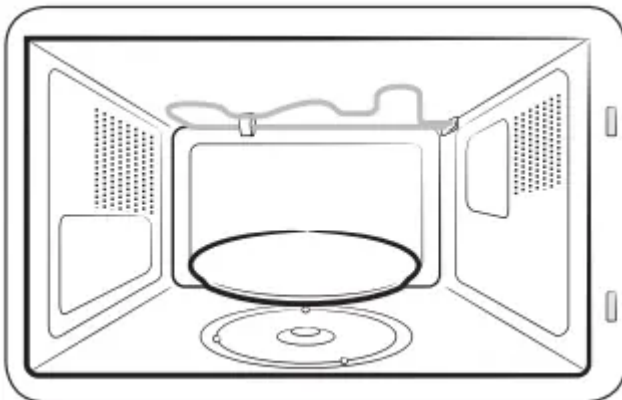

1. Place the crusty plate directly on the turntable and preheat it with highest Microwave-Grill-Combination by following the times and instructions in the chart.
2. Brush the plate with oil if you are cooking food, such as bacon and eggs, in order to brown the food nicely.

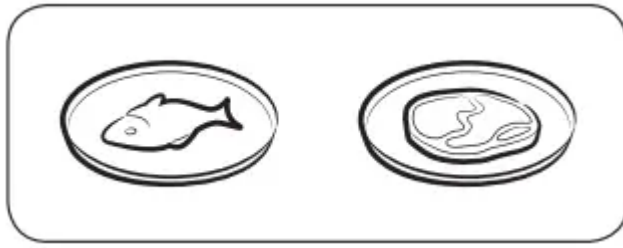

3. Place the food on the crusty plate.

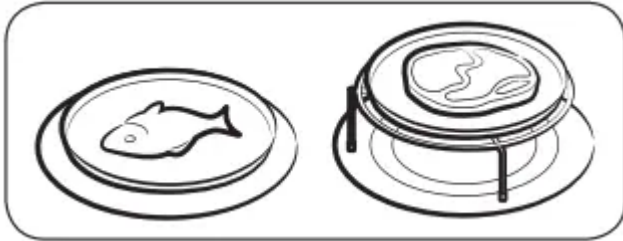

4. Place the crusty plate on the metal rack (or turntable) in the microwave.



5. Select the appropriate cooking time and power.

(Refer to the table on the side)

CAUTION

- Always use oven gloves to take out the crusty plate, as will become very hot.
- Do not place any objects on the crusty plate that are not heat-resistant.
- Never place the crusty plate in the oven without turntable.
- Please note that the crust plate is not dish washer-safe.

NOTE

- Please note that the crusty plate has a teflon layer which is not scratchresistant. Do not use any sharp objects like a knife to cut on the crusty plate.
- Clean the crusty plate with warm water and detergent and rinse off with clean water.
- Do not use a scrubbing brush or a hard sponge otherwise the top layer will be damaged.

Using Child Lock

Your microwave oven is fitted with a special child lock programme, which enables the microwave oven to be “locked” so that children or anyone unfamiliar with it cannot operate it accidentally.



- To activate Child Lock, press and hold START/+30s for 3 seconds.

- The control panel is locked, and the control panel display shows “L”.



- To deactivate Child Lock, press and hold START/+30s again for 3 seconds.

Switching the beeper off

You can switch the beeper off whenever you want.

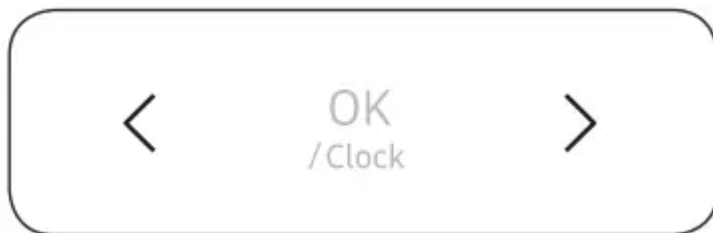

- To turn the beeping sound off, press < or > (Decrease/Increase) at the same time.
- To turn the beeping sound back on, press < or > (Decrease/Increase) at the same time again.

Troubleshooting and information code

Troubleshooting

If you have any of the problems listed below try the solutions given.

| Problem | Cause | Action |
|--|--|--|
| General | | |
| The buttons cannot be pressed properly. | Foreign matter may be caught between the buttons. | Remove the foreign matter and try again. |
| | For touch models: Moisture is on the exterior. | Wipe the moisture from the exterior. |
| | Child lock is activated. | Deactivate Child lock. |
| The time is not displayed. | The Eco (power-saving) function is set. | Turn off the Eco function. |
| The microwave oven does not work. | Power is not supplied. | Make sure power is supplied. |
| | The door is open. | Close the door and try again. |
| | The door open safety mechanisms are covered in foreign matter. | Remove the foreign matter and try again. |
| The microwave oven stops while in operation. | The user has opened the door to turn food over. | After turning over the food, press the START/+30s button again to start operation. |



| Problem | Cause | Action |
|---|--|---|
| The power turns off during operation. | The microwave oven has been cooking for an extended period of time. | After cooking for an extended period of time, let the microwave oven cool. |
| | The cooling fan is not working. | Listen for the sound of the cooling fan. |
| | Trying to operate the microwave oven without food inside. | Put food in the microwave oven. |
| | There is not sufficient ventilation space for the microwave oven. | There are intake/exhaust outlets on the front and rear of the microwave oven for ventilation. Keep the gaps specified in the product installation guide. |
| | Several power plugs are being used in the same socket. | Designate only one socket to be used for the microwave oven. |
| There is a popping sound during operation, and the microwave oven doesn't work. | Cooking sealed food or using a container with a lid may causes popping sounds. | Do not use sealed containers as they may burst during cooking due to expansion of the contents. |

| Problem | Cause | Action |
|---|---|--|
| The microwave oven exterior is too hot during operation. | There is not sufficient ventilation space for the microwave oven. | There are intake/exhaust outlets on the front and rear of the microwave oven for ventilation. Keep the gaps specified in the product installation guide. |
| | Objects are on top of the microwave oven. | Remove all objects on the top of the microwave oven. |
| The door cannot be opened properly. | Food residue is stuck between the door and microwave oven interior. | Clean the microwave oven and then open the door. |
| Heating including the Warm function does not work properly. | The microwave oven may not work, too much food is being cooked, or improper cookware is being used. | Put one cup of water in a microwave-safe container and run the microwave for 1-2 minutes to check whether the water is heated. Reduce the amount of food and start the function again. Use a cooking container with a flat bottom. |
| The thaw function does not work. | Too much food is being cooked. | Reduce the amount of food and start the function again. |
| The interior light is dim or does not turn on. | The door has been left open for a long time. | The interior light may automatically turn off when the Eco function operates. Close and reopen the door or press the STOP/Eco button. |
| | The interior light is covered by foreign matter. | Clean the inside of the microwave oven and check again. |

Troubleshooting and information code

| Problem | Cause | Action |
|--|---|--|
| A beeping sound occurs during cooking. | If the Auto Cook function is being used, this beeping sound means it's time to turn over the food during thawing. | After turning over the food, press the START/+30s button again to restart operation. |
| The microwave oven is not level. | The microwave oven is installed on an uneven surface. | Make sure the microwave oven is installed on flat, stable surface. |
| There are sparks during cooking. | Metal containers are used during the microwave oven/ thawing functions. | Do not use metal containers. |
| When power is connected, the microwave oven immediately starts to work. | The door is not properly closed. | Close the door and check again. |
| There is electricity coming from the microwave oven. | The power or power socket is not properly grounded. | Make sure the power and power socket are properly grounded. |
| <ol style="list-style-type: none"> 1. Water drips. 2. Steam emits through a door crack. 3. Water remains in the microwave oven. | There may be water or steam in some cases depending on the food. This is not an microwave oven malfunction. | Let the microwave oven cool and then wipe with a dry dish towel. |

| Problem | Cause | Action |
|---|--|--|
| The brightness inside the microwave oven varies. | Brightness changes depending on power output changes according to function. | Power output changes during cooking are not malfunctions. This is not an microwave oven malfunction. |
| Cooking is finished, but the cooling fan is still running. | To ventilate the microwave oven, the cooling fan continues to run for about 3 minutes after cooking is complete. | This is not an microwave oven malfunction. |
| Turntable | | |
| While turning, the turntable comes out of place or stops turning. | There is no roller ring, or the roller ring is not properly in place. | Install the roller ring and then try again. |
| The turntable drags while turning. | The roller ring is not properly in place, there is too much food, or the container is too large and touches the inside of the microwave. | Adjust the amount of food and do not use containers that are too large. |
| The turntable rattles while turning and is noisy. | Food residue is stuck to the bottom of the microwave oven. | Remove any food residue stuck to the bottom of the microwave oven. |

| Problem | Cause | Action |
|--|---|---|
| Grill | | |
| Smoke comes out during operation. | During initial operation, smoke may come from the heating elements when you first use the microwave oven. | This is not a malfunction, and if you run the microwave oven 2-3 times, it should stop. |
| | Food is on the heating elements. | Let the microwave oven cool and then remove the food from the heating elements. |
| | Food is too close to the grill. | Put the food a suitable distance away while cooking. |
| | Food is not properly prepared and/or arranged. | Make sure food is properly prepared and arranged. |
| Microwave oven | | |
| The microwave oven does not heat. | The door is open. | Close the door and try again. |
| Smoke comes out during preheating. | During initial operation, smoke may come from the heating elements when you first use the microwave oven. | This is not a malfunction, and if you run the microwave oven 2-3 times, it should stop. |
| | Food is on the heating elements. | Let the microwave oven cool and then remove the food from the heating elements. |
| There is a burning or plastic smell when using the | Plastic or non heat-resistant cookware is used. | Use glass cookware suitable for high temperatures. |

| | | |
|-----------------|--|--|
| microwave oven. | | |
|-----------------|--|--|

| Problem | Cause | Action |
|---|---|--|
| There is a bad smell coming from inside the microwave oven. | Food residue or plastic has melted and stuck to the interior. | Use the steam function and then wipe with a dry cloth. You can put a lemon slice inside and run the microwave oven to remove the odour more quickly. |
| The microwave oven does not cook properly. | The microwave oven door is frequently opened during cooking. | If you open the door often, the interior temperature will be lowered and this may affect the results of your cooking. |
| | The microwave oven controls are not correctly set. | Correctly set the microwave oven controls and try again. |
| | The grill or other accessories are not correctly inserted. | Correctly insert the accessories. |
| | The wrong type or size of cookware is used. | Use suitable cookware with flat bottoms. |

Information code

| Information code | Cause | Action |
|------------------|--|---|
| C-d0 | Control buttons are pressed over 10 seconds. | Clean the keys and check if there is water on the surface around key. If it occurs again, turn off the microwave oven over 30 seconds and try setting again. If it appears again, call your local SAMSUNG Customer Care Centre. |

NOTE if the suggested solution does not solve the problem, contact your local SAMSUNG Customer Care Centre.

Warning

This content is compiled from multiple sources and is provided for reference purposes only. It may not be complete or fully applicable to all situations. If you are unable to resolve your issue, please contact the product manufacturer or an authorized service provider for official support.

