

## CONTROL PANEL

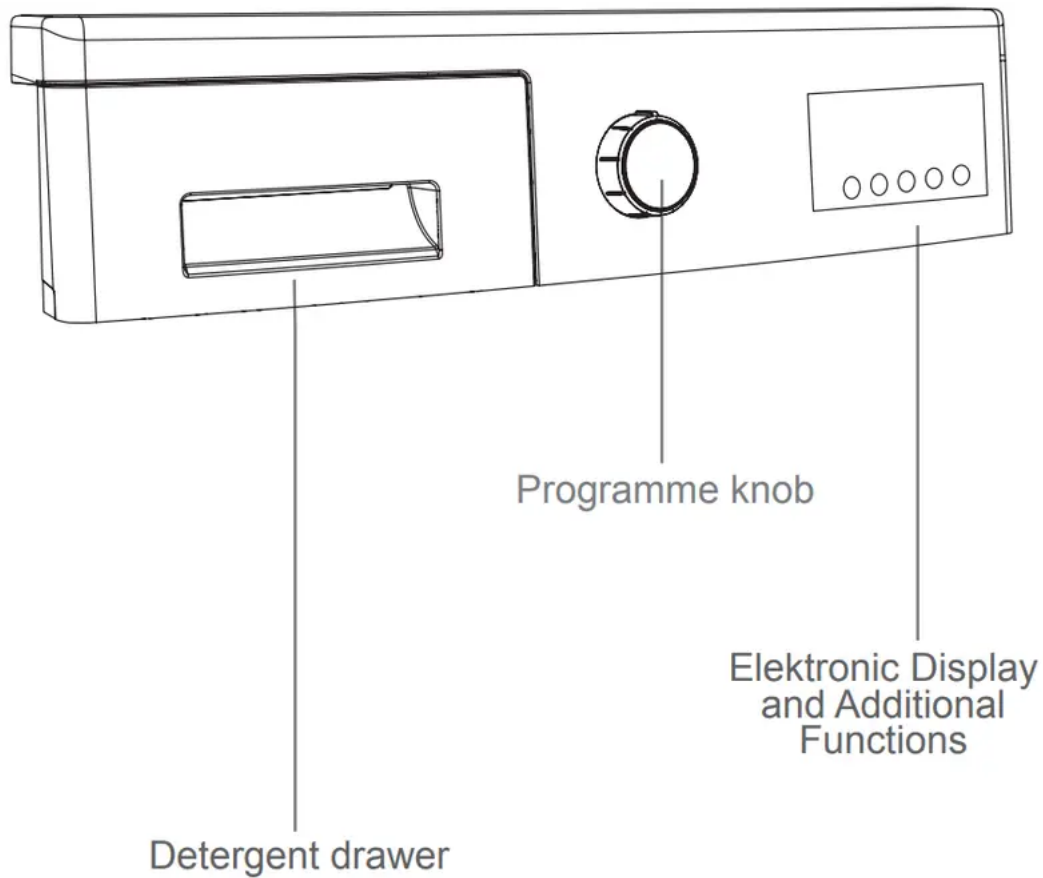

## DETERGENT DRAWER

You can use the liquid level determination plate when you want to wash your laundry with liquid detergent. You can use your liquid detergents in all programs without prewashing. Place the liquid detergent apparatus in the second compartment (which is available inside the machine) of the detergent drawer (\*) and set the detergent amount. (Use the recommended amount of liquid detergent by detergent producers). Do not exceed the MAX level, use only for liquid detergent, do not use this apparatus for powder detergent and take it out.)

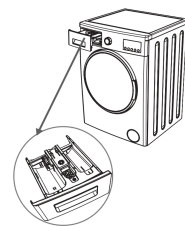

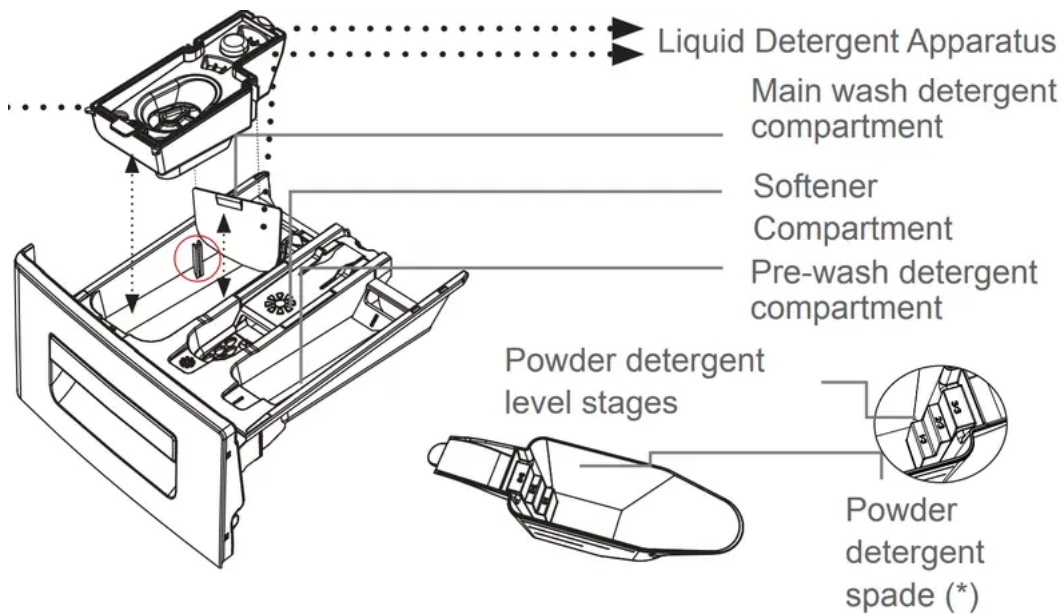

## SECTIONS

### ***Main wash detergent compartment:***

In this compartment, only materials like detergent (liquid or powder), lime preventer and such can be used.

You can find the liquid detergent apparatus inside your machine at first installation.

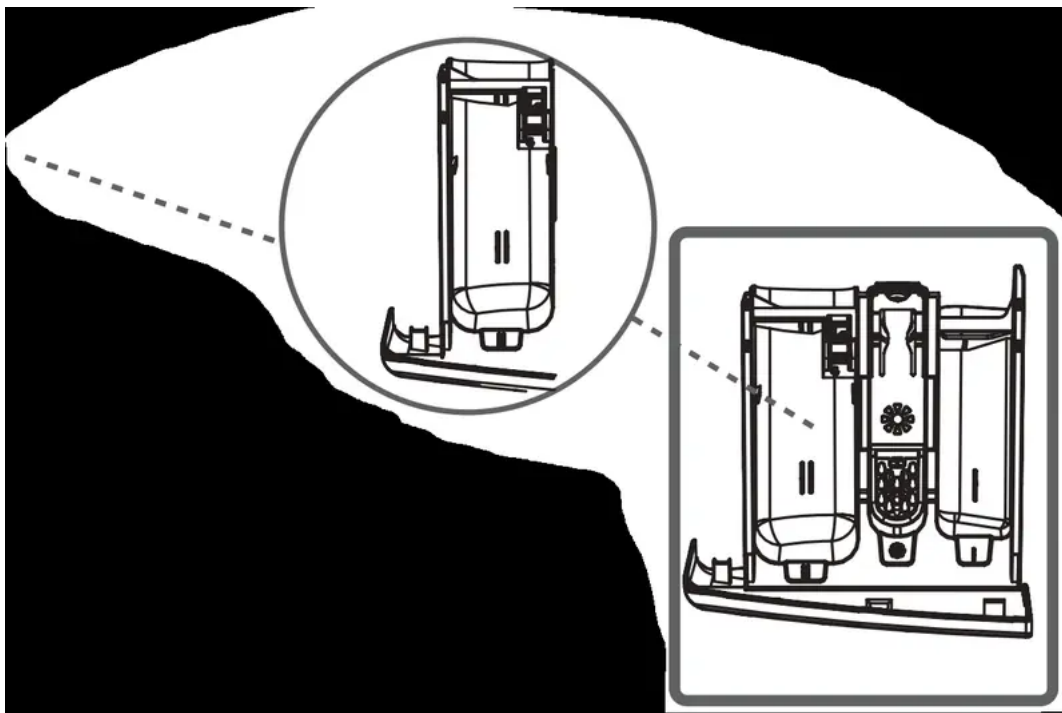

### ***Fabric conditioner, starch, detergent compartment:***

You can use softener for your laundry recommended amount and type by the producer is recommended). Sometimes the fabric conditioners you use for your laundry may remain in this compartment. The reason for this is that the conditioner is not vicious. To prevent this situation,

more viscous liquid softeners are recommended to be used or the softener could be thinned and then used.

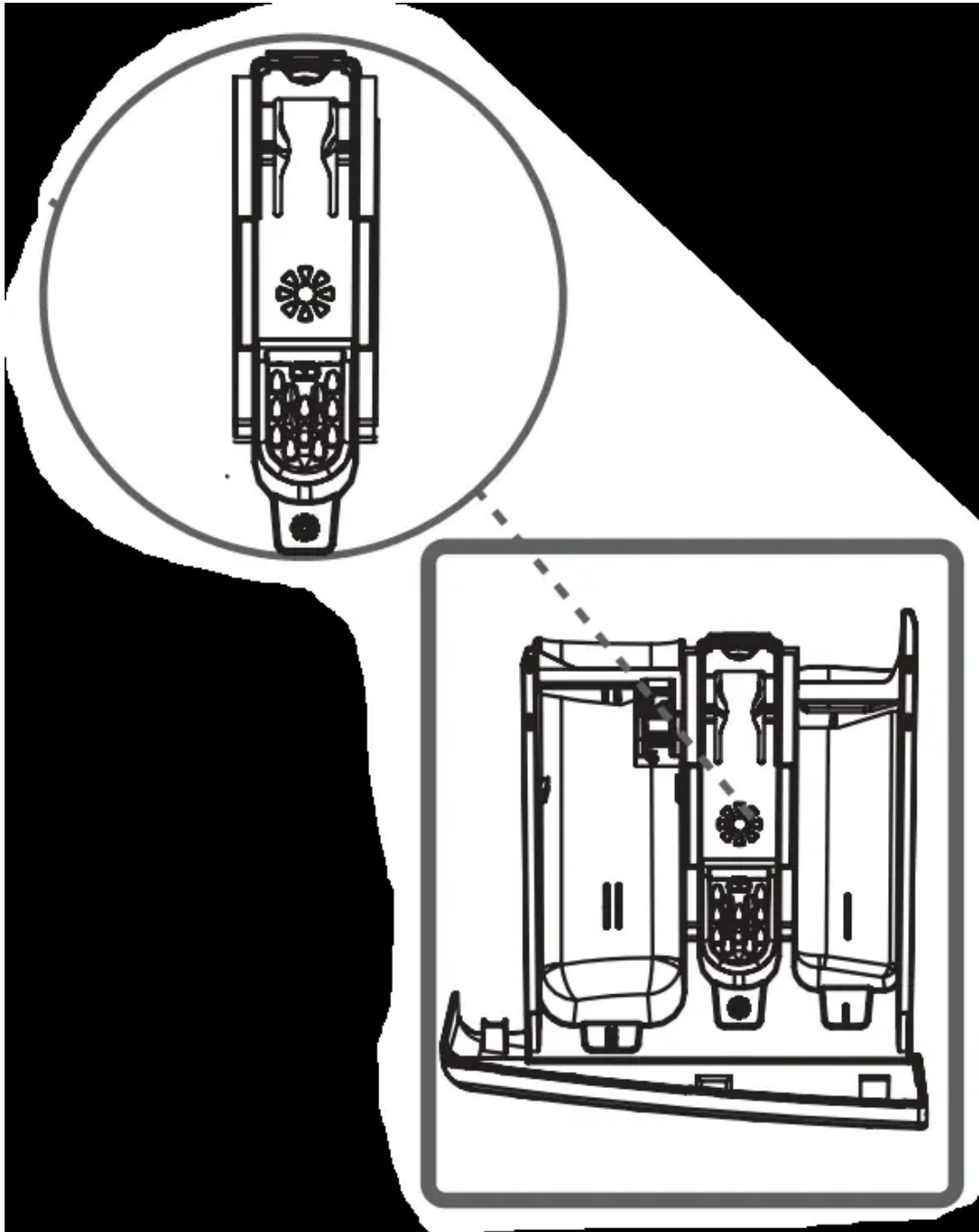

***Pre-wash detergent compartment:***

This compartment must only be used when the pre-wash feature is selected.

Pre-wash feature is recommended for very dirty laundry.



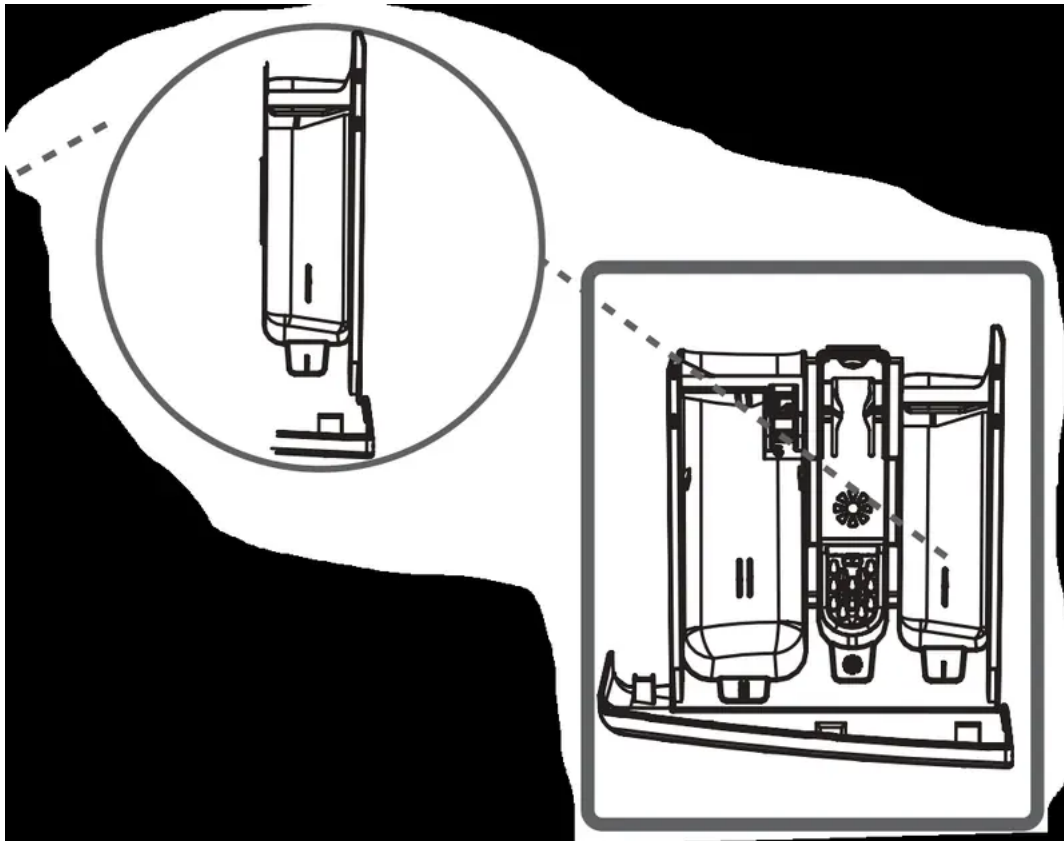

## PROGRAM KNOB

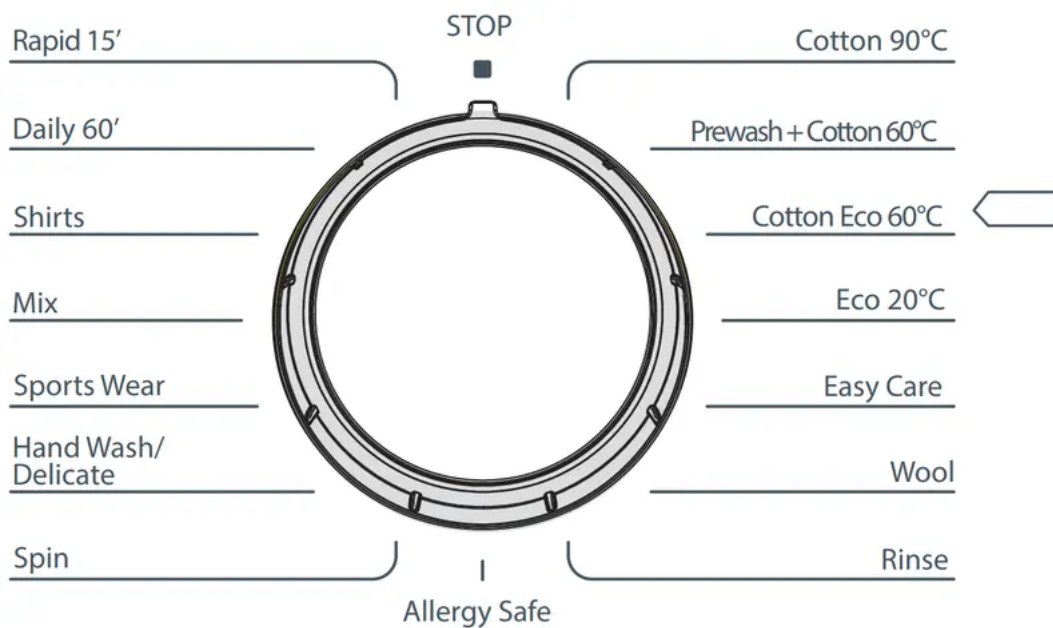

- You can select the programme you want to wash your laundry in through programme knob.
- You may set the programme selection operation by rotating the programme knob in both directions.
- Ensure that the programme knob is exactly on the programme you want to select.

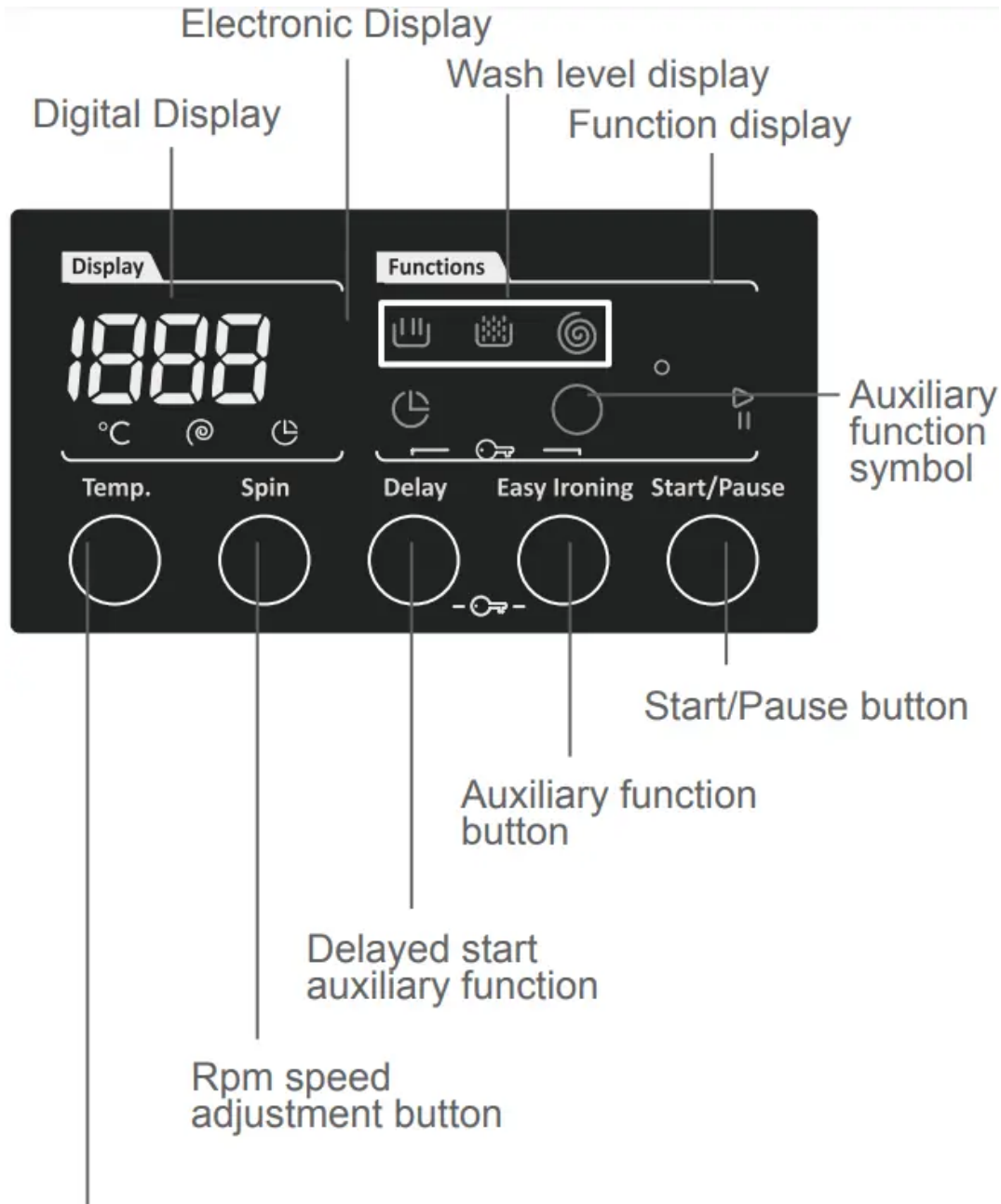

## ELECTRONIC DISPLAY





### Water Temperature Adjustment Button

On the electronic display, you may view washing water temperature, spinning revolution speed of your machine, when your machine will finish washing, the auxiliary functions you have selected and at what stage the programme you have chosen is (  → prewash/wash,  → rinsing,  → spinning).

Furthermore, electronic display will warn you by means of fault symbols on the display when a fault occurs on your machine and notify you of the completion of the washing programme by revealing expression of “END” on the display as soon as the washing programme you have selected has finished as well.

## PREPARATION FOR LAUNDERING

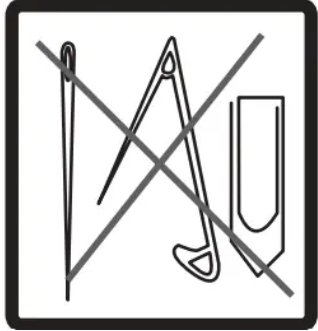
<ul style="list-style-type: none"><li>• Your laundry has product labels on them that specify their specifications. Wash or dry your laundry according to the specifications on the product label.</li></ul>	
<ul style="list-style-type: none"><li>• Separate your laundries according to their types (cotton, synthetic, sensitive, wool etc.), their temperatures (cold, 30°, 40°, 60°, 90°) and degree of contamination (slightly stained, stained, highly stained).</li></ul>	
<ul style="list-style-type: none"><li>• Never wash your coloured and white laundry together.</li></ul>	
<ul style="list-style-type: none"><li>• Wash your coloured laundries separately in the first washing as they may bleed.</li></ul>	
<ul style="list-style-type: none"><li>• Ensure that there are no metallic materials on your laundries or in the pockets; if so, take them up.</li></ul>	

**CAUTION: WARNING:** Faults that will emerge in case of penetration of foreign substances into your machine are not included within the scope of warranty.

- Zip up and button up your laundries.



- Remove the metallic or plastic hooks of tulle curtains or curtains or place them in a washing net or bag and then muzzle them.













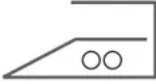
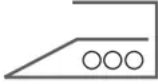
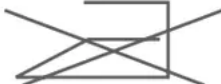

- Reverse textiles such as pants, knitwear, t-shirt and sweat suit.



- Wash socks, handkerchiefs and suchlike small laundries in a washing net.



		
Whitening available	No whitening	Normal washing
		
Ironing temperature is maximum 150°C	Ironing temperature is maximum 200°C	No ironing
		
Dry cleaning available	No dry cleaning	Leave on a flat place
		
Hang when wet	Dry by hanging	Drying by twirling is not allowed
		
Dry cleaning in gas oil, pure alcohol and R113 is allowed	Perchloroethylene R11, R13, Petroleum	Perchloroethylene R11, R13, Gas oil

- Open the door of your machine.
- Spread your laundries in your machine.



**NOTE:** Note: Maximum loading capacity may vary based on the laundry type you will wash, degree of contamination and the programme you have chosen. Do not exceed maximum dry loading capacity indicated in the programme table for washing programmes.

You can take the following table of weights as an example.

LAUNDRY TYPE	WEIGHT (gr)
Towel	200
Linen	500
Bathrobe	1200
Quilt cover	700
Pillow slip	200
Underwear	100
Tablecloth	250

- Put each item of laundry separately.
- Ensure that no laundry is stuck between the cover and bellow seal when closing the door of your machine.
- Push the door of your machine until hearing the locking sound to close it.

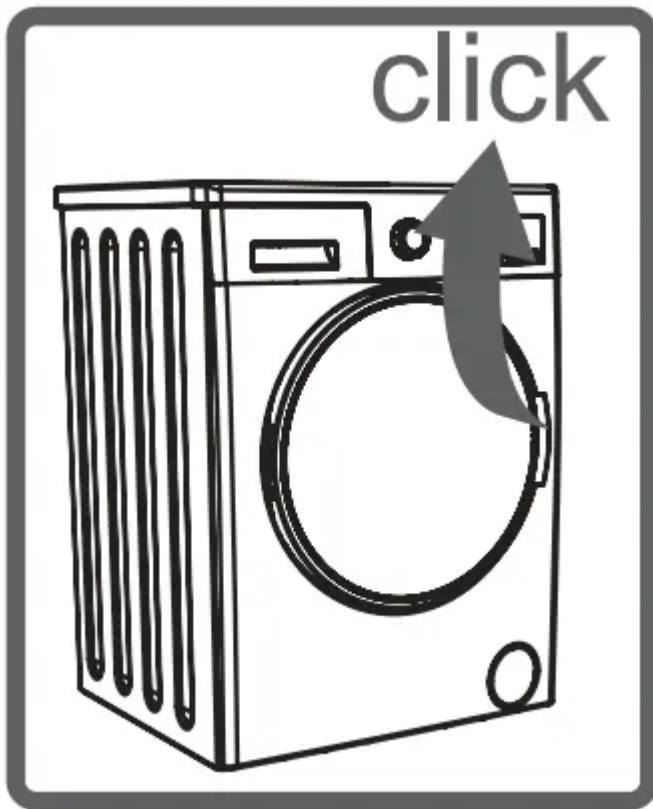

- Close the door of your machine properly, otherwise your machine will not start the washing operation.

## ADDING DETERGENT

- The amount of detergent you will put in your machine will depend on the following criteria:
- Your detergent utilization will be based on the degree of contamination of your laundries. Do not prewash your less stained laundries and put your slight amount of detergent in the 2nd compartment of the detergent drawer.
- For your much stained laundries, select a programme including prewashing, and put  $\frac{1}{4}$  of the detergent you will put in the detergent drawer in the 1st compartment of the detergent drawer while putting the remaining  $\frac{3}{4}$  of it into 2nd compartment.
- Use detergents produced for automatic washing machine in your machine. The amount of detergent you will use for your laundries is printed on the detergent package.
- The higher the degree of hardness of the water the more detergent you will use.
- The amount of the detergent you will use will increase as the amount of your laundries increase.
- Put the softener in the softener compartment in the detergent drawer. Do not exceed the MAX level. Otherwise, softener will flow into washing water through flushing.

- Softeners with high density are required to be thinned to a degree before being put in the drawer. Because high-density softener will clog the flush and avoid the flow of the softener.
- You can use your liquid detergents in all programs without prewashing. For this, fit liquid detergent level plate in the accessories bag or the liquid detergent apparatus (\*) into 2nd compartment of the detergent drawer and set the amount of liquid detergent according to the levels on this plate. Remember to detach the liquid detergent plate.

## OPERATING YOUR MACHINE

- Plug your machine in.
- Open the water faucet.

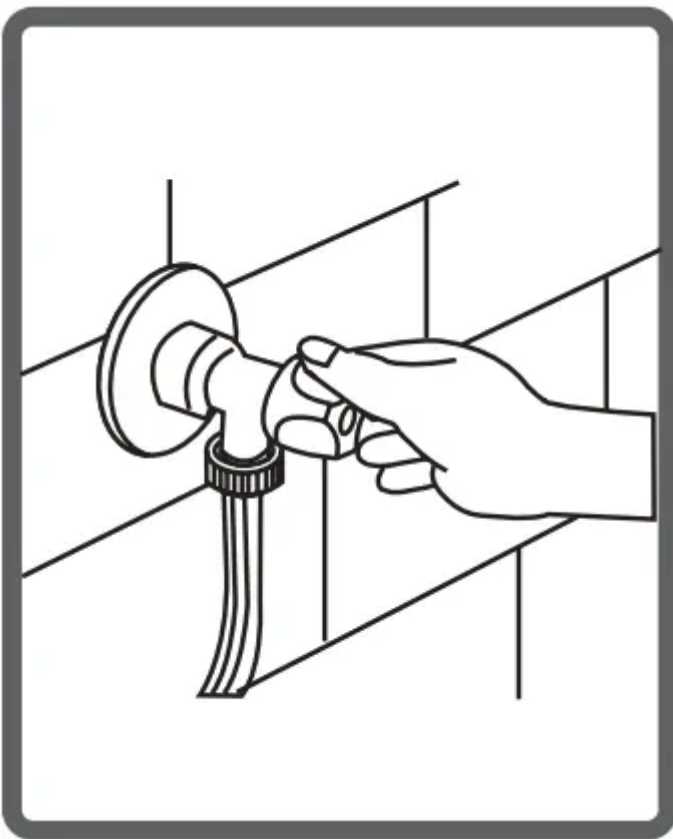

- Open the machine door.
- Spread your laundries in your machine.
- Push the door of your machine until hearing the locking sound to close it.

### Selecting programme

Select the convenient programme for your laundries on the programme table.

### AUXILIARY FUNCTIONS

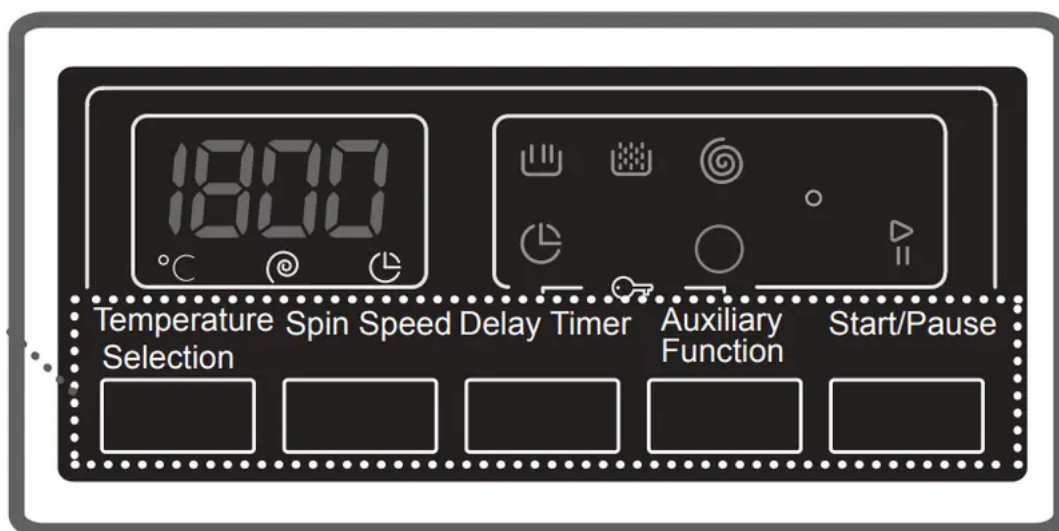

Before starting the programme, you can optionally select an auxiliary function.

- Press on the button of auxiliary function you would like to select.
- If auxiliary function symbol on electronic display flashes continuously, the auxiliary function you have selected will be activated.
- If auxiliary function symbol on electronic display blinks, the auxiliary function you have selected will not be activated.

**Reason for non-activation:**

- The auxiliary function you want to use in the washing programme you have selected is not applicable.
- Your machine has passed over the stage, during which the auxiliary function you would like to select would be implemented.
- It is not compatible with an auxiliary function you have selected previously.

**HALF-LOAD DETECTION SYSTEM**

Your machine features a half-load detection system.

In case you put approximately half or less amount of laundries of maximum laundry capacity in your machine, your machine will run so as to save washing time, water consumption and energy in some programmes. When the halfload function is active, the machine can complete the programme you have set in a shorter time.

**TWINJET SYSTEM(\*)**

Detergent water in your machine will be circulated with 2 water injection mechanisms and a mixing system via twinjet system.

Circulated detergent water will be injected over your laundries, which allows a better washing performance.



Twinjet system will help you wash higher amount of laundries in a shorter time with a better washing performance, guaranteeing less energy and water consumption.

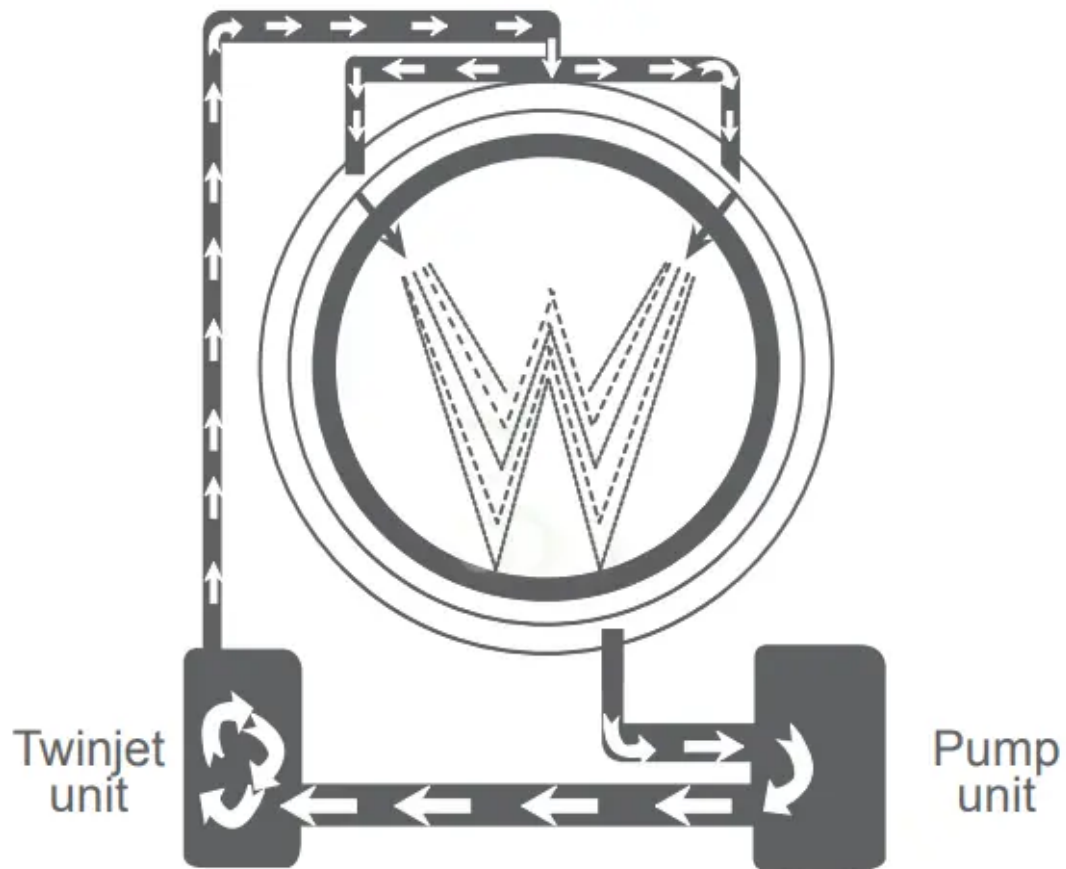

## AUXILIARY FUNCTIONS

### 1- Temperature selection

You can select the washing water temperature with the washing water temperature adjustment button.

Whenever you select a new programme, the maximum washing water temperature is shown on the washing water temperature display.

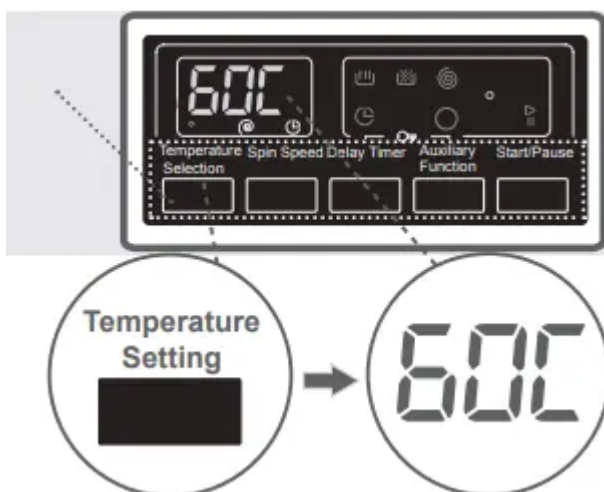

You can gradually decrease the washing water temperature between the maximum temperature and cold washing (--) by pressing washing water temperature adjustment button.

If you have missed the washing water temperature you wanted, you can return to the intended temperature by continuously pressing the washing water temperature adjustment button.

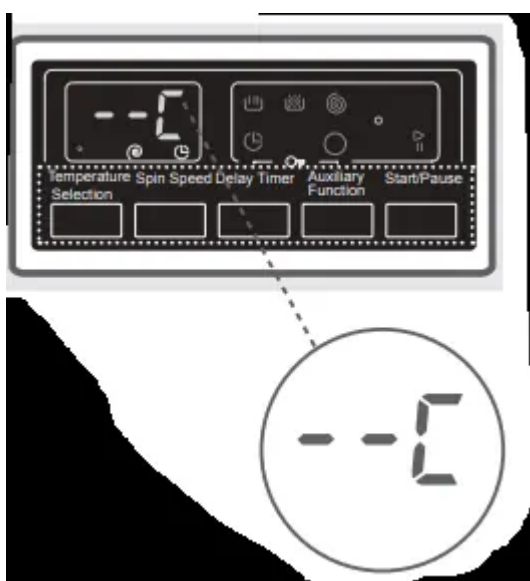

## 2- Spin speed selection

You can set the spin revolution for your laundries via revolution speed setting button.

When you select a new programme, the maximum spin revolution speed of the programme you have selected will be viewed on the display of revolution speed.

You can gradually reduce the revolution speed between cancel spinning (--) options through the maximum spin revolution of the programme selected by pressing revolution speed setting button.

If you have skipped the spinning revolution you want to set, you can re-switch to the revolution by keeping the revolution setting button pressed.

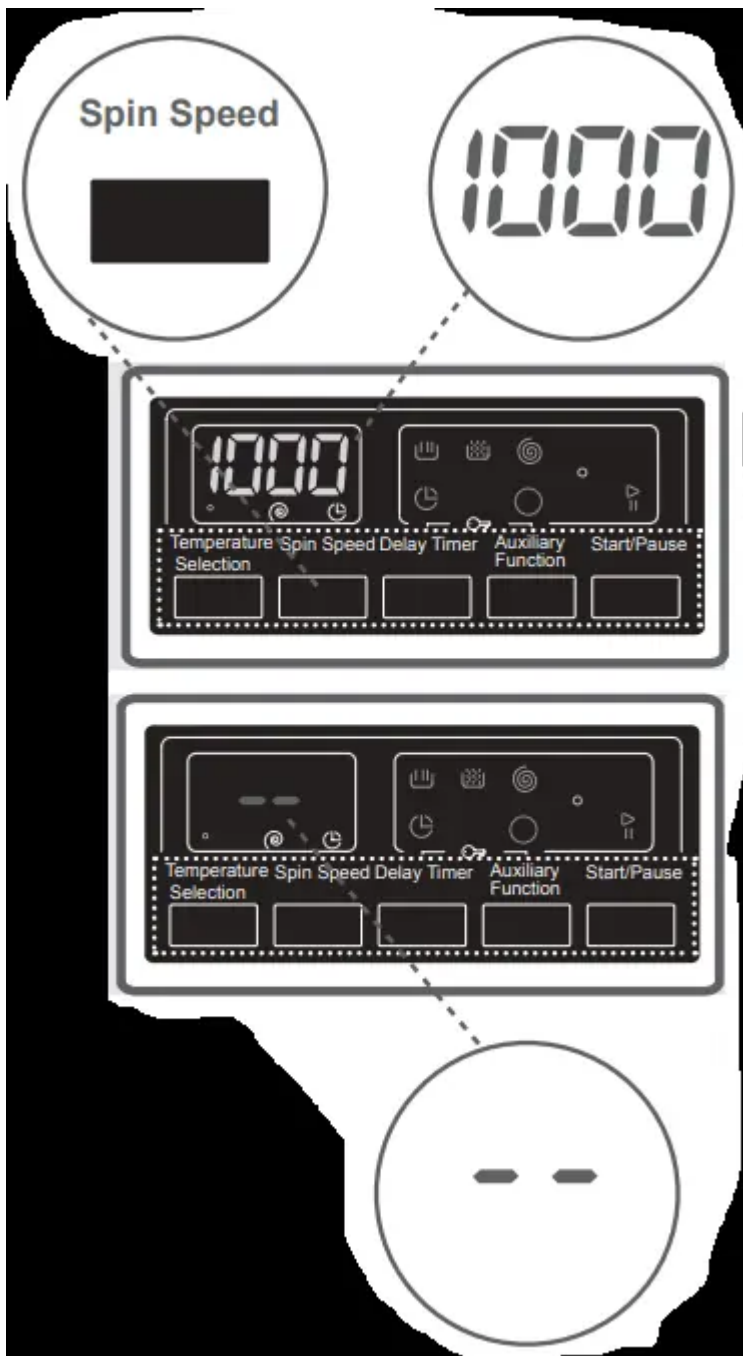

### 3- Delay timer

By using this auxiliary function, you can set the time when your machine start washing. This time can vary from an hour to 23 hours.

#### ***To use auxiliary function of delay timer:***

- Press time delay button once. - Expression of "1 h" will appear on the display. - Symbol



will flash on electronic display.

- Press on time delay button until the time, on which you want washing operation to be started.

- To activate the time delay you have selected in the programme, you may press on any auxiliary function button you like except “Start/Standby” button.
- If you have skipped the time delay you want to set, you can go back to the time desired by keeping pressed on time delay button.
- If you want to cancel the time delay, you are required to press the time delay button

once.  symbol will no longer flash on electronic display.

- To run time delay function, your machine is required to be operated by pressing on Start/ Pause button.

#### 4- Easy ironing(\*)

You can enable your laundries to be taken out less wrinkled as the washing operation is completed by employing this auxiliary function.

When you press on the easy ironing auxiliary function, the  symbol on the electronic display will flash.

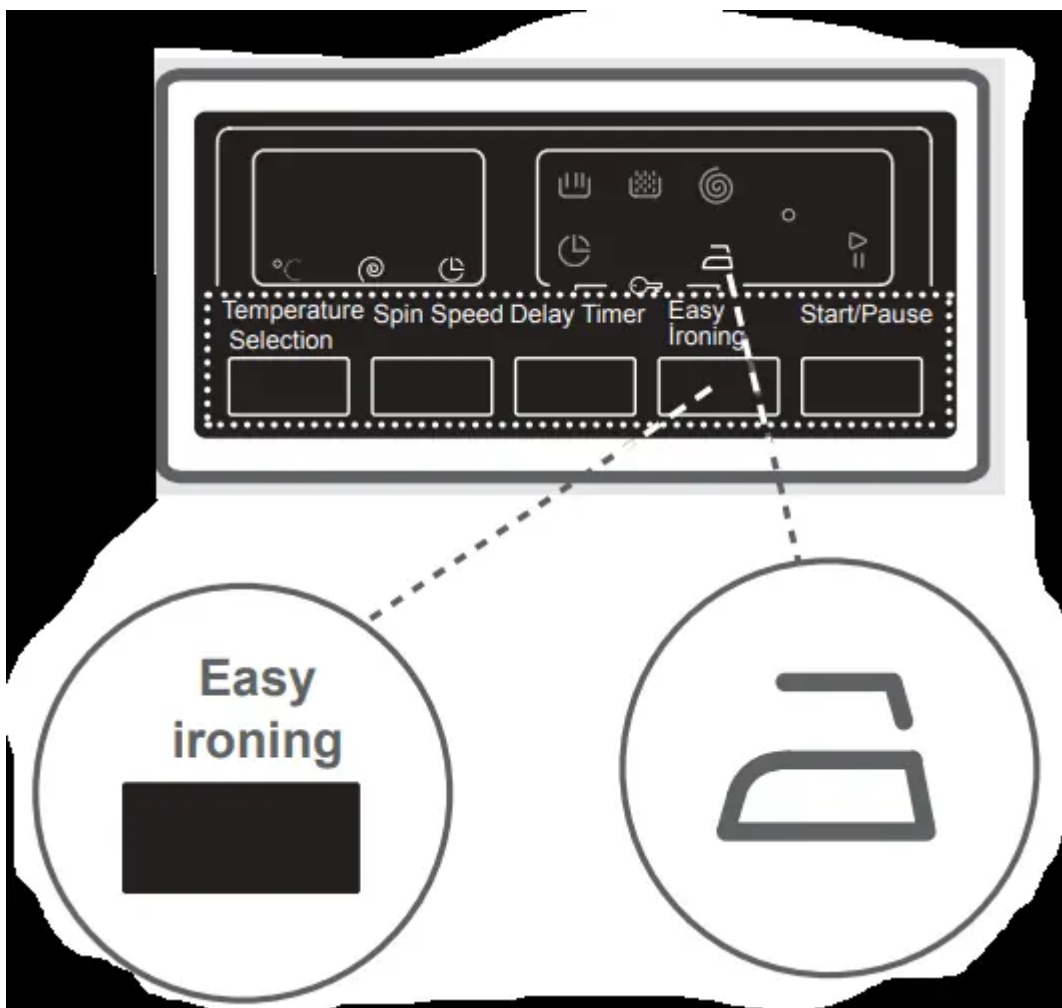

#### 5- Anti-allergic(\*)

In the programmes where this auxiliary function is active, your machine will perform an extra rinsing operation on your laundries prior to latest rinsing operation.



When you press on the Anti allergic auxiliary function, the symbol on the electronic display will flash.

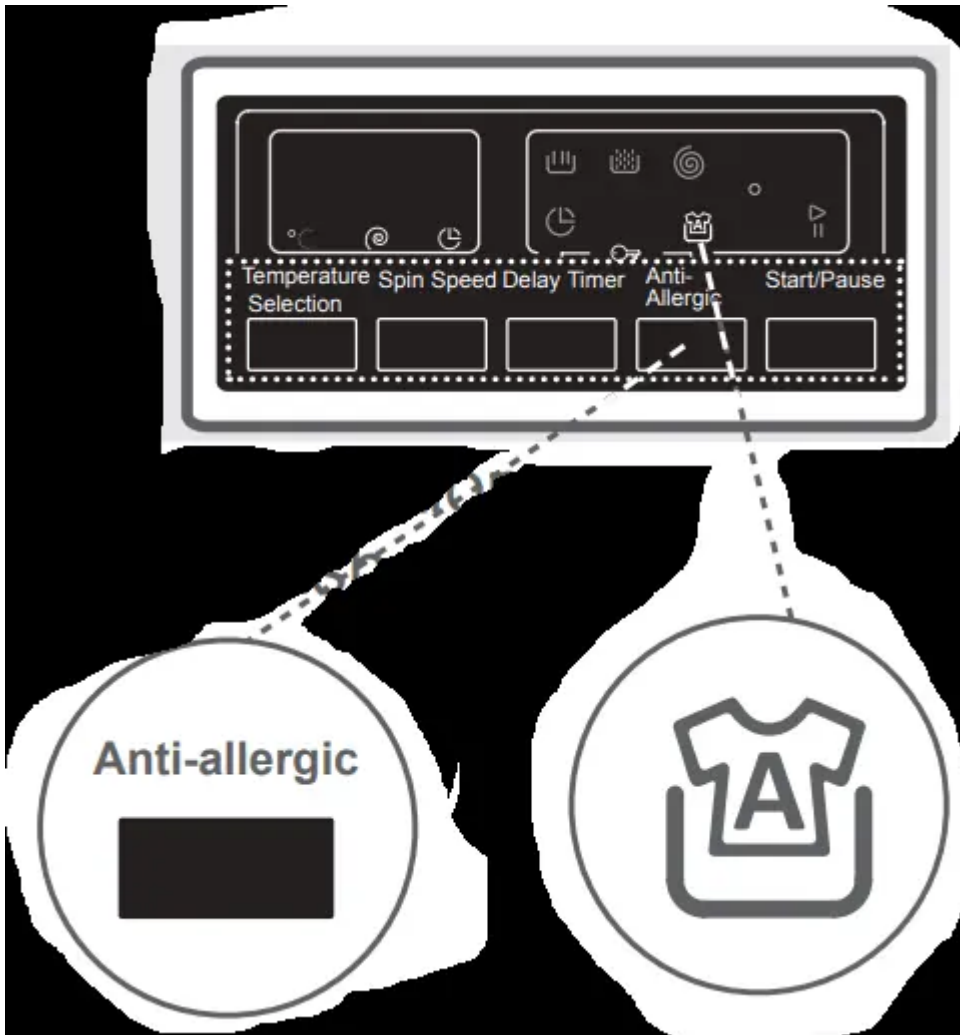

### 6- Rapid wash(\*)

This auxiliary function will enable the washing duration of your laundries that are not very dirty to be shortened.

In case you put half or less than half of the laundry capacity of the washing programme you have selected in your machine, your machine will detect this thanks to automatic half-load detection system and the programme you have selected will wash your laundries in a shorter time to consume less energy and water.



If your machine detects half load, the  symbol will automatically flash on electronic display.

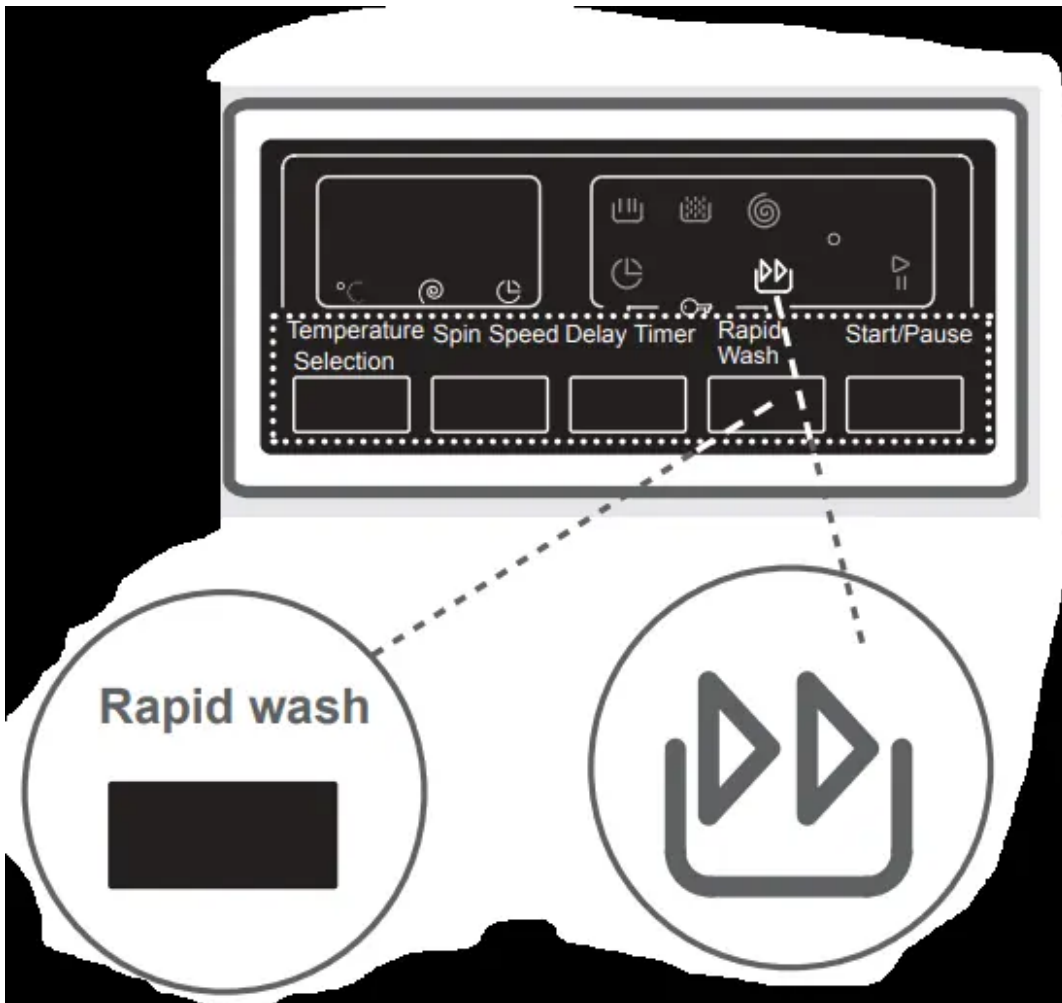

### 7- Pre-wash(\*)

You can expose your very dirty laundries to prewashing operation prior to main washing by using this additional function.

When you use this function, you should put detergent in the pre-washing compartment of the detergent drawer.

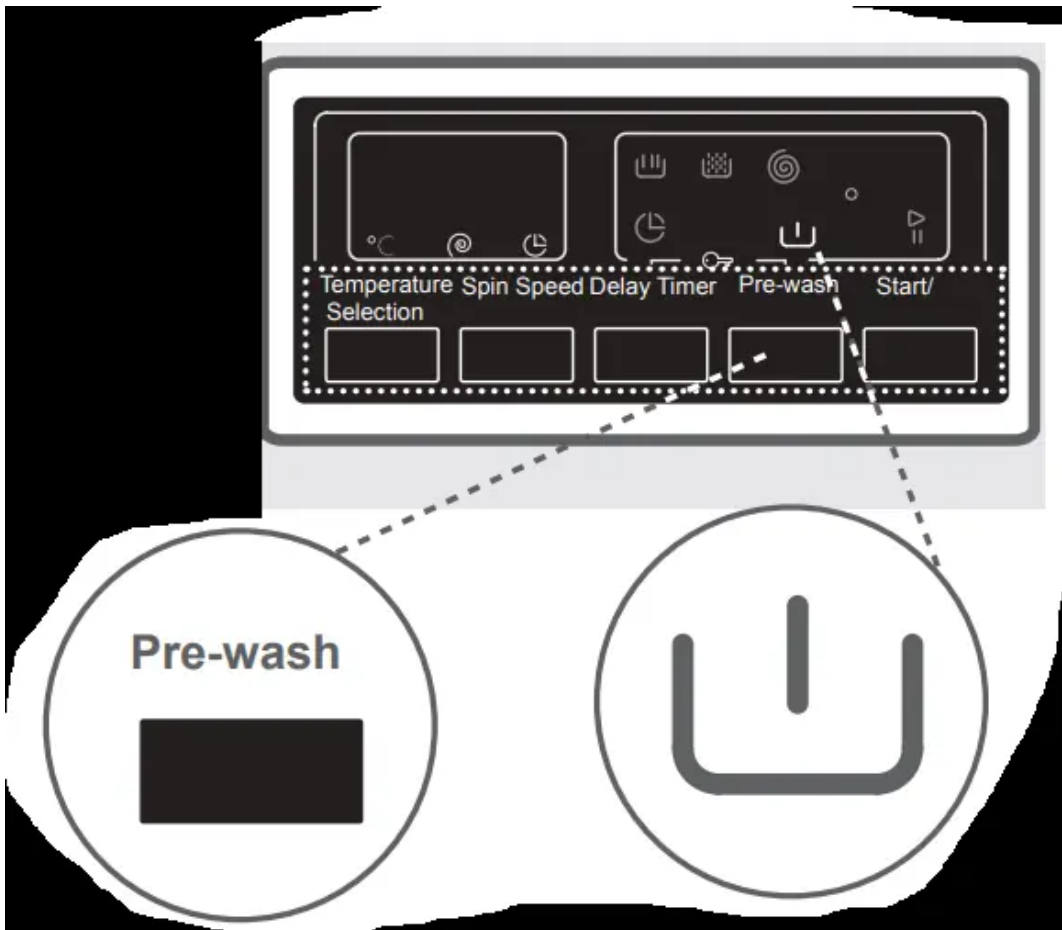

### 8- Extra Rinse(\*)

You can make additional rinse operation on your laundry by using this additional function.

You may make the programme active by pressing the extra rinsing auxiliary function button when



the led light of the symbol turns on.

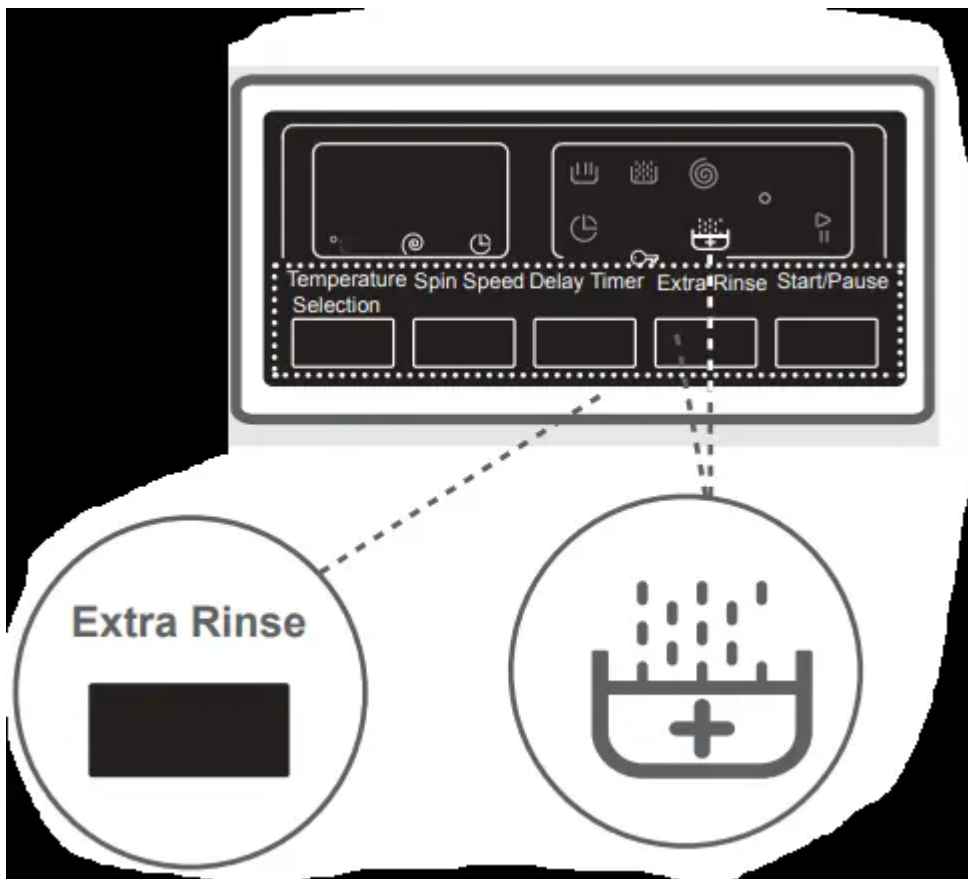

### 9- Start/Pause button

By pressing on the Start/Pause button, you may start the programme you have selected or suspend a running programme. If you switch your machine to the standby mode, the Start/Standby led on the electronic display will blink.

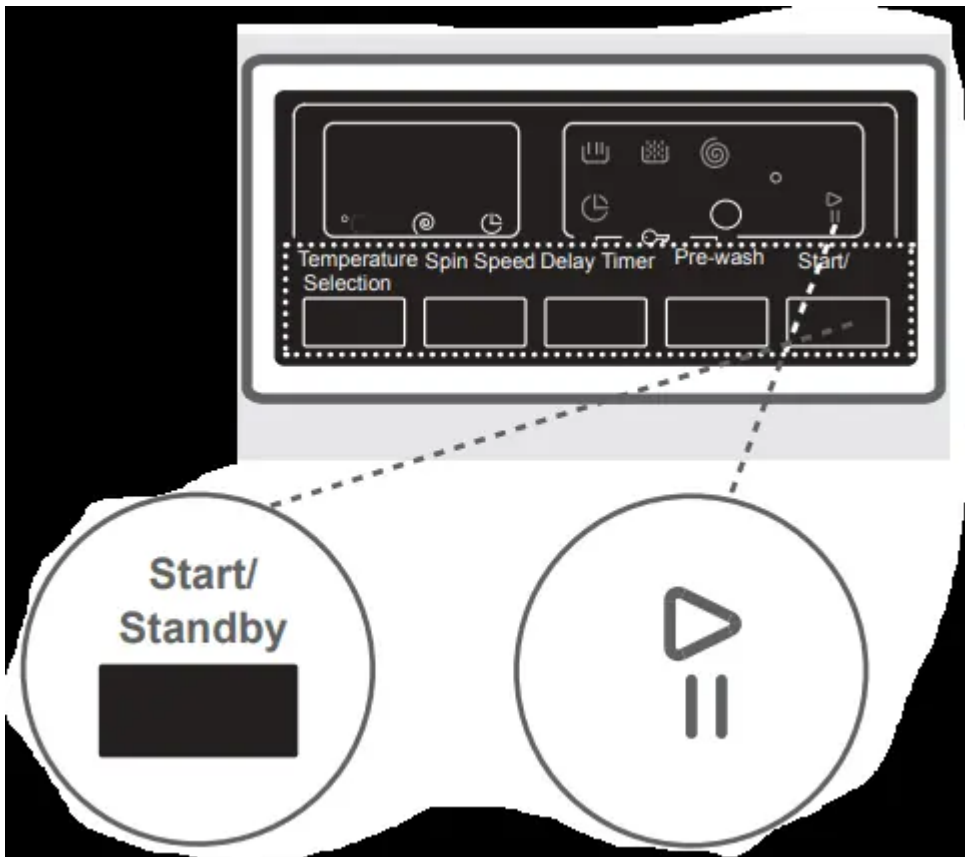

## CHILD LOCK

To avoid programme flow from being affected if programme buttons are pressed or programme button is turned when performing washing operation in your machine, child lock is available.

Child lock will be activated in case pressed on both auxiliary functions 3 and 4 at the same time for more than 3 seconds.

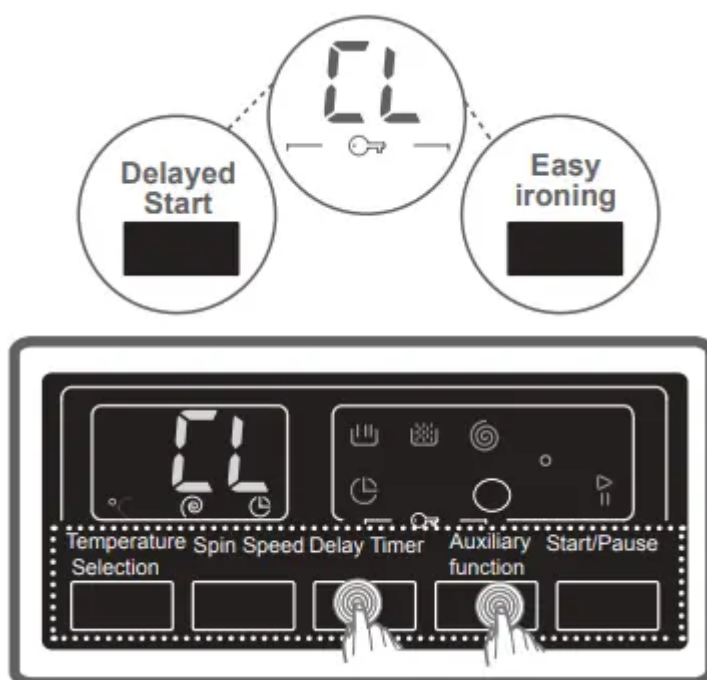

"CL" symbol will flash on the electronic display when activated.

If pressed any button while childlock is active, the "CL" symbol will blink on the electronic display.

If while the child lock is engaged and any programme is running, the programme knob is switched to "O" and another programme is selected, the programme previously selected continues from where it left.

To deactivate it, it will be sufficient to press on the same buttons for more than 3 seconds. When the child lock is deactivated, the "CL" symbol on the electronic display will go off.

## CANCELLING PROGRAMME

If you want to cancel any programme running:

1. Switch the programme knob to position "O".
2. Your machine will stop the washing operation and the programme will be cancelled.
3. To get rid of the water accumulated in the machine switch the programme knob to any programme.
4. Your machine will perform the necessary discharge operation and cancel the programme.
5. You can run your machine by selecting a new programme.

## FINISHING PROGRAMME

Your machine will stop by itself as soon as the programme you have selected finishes.

- The expression of "END" will flash on the electronic display

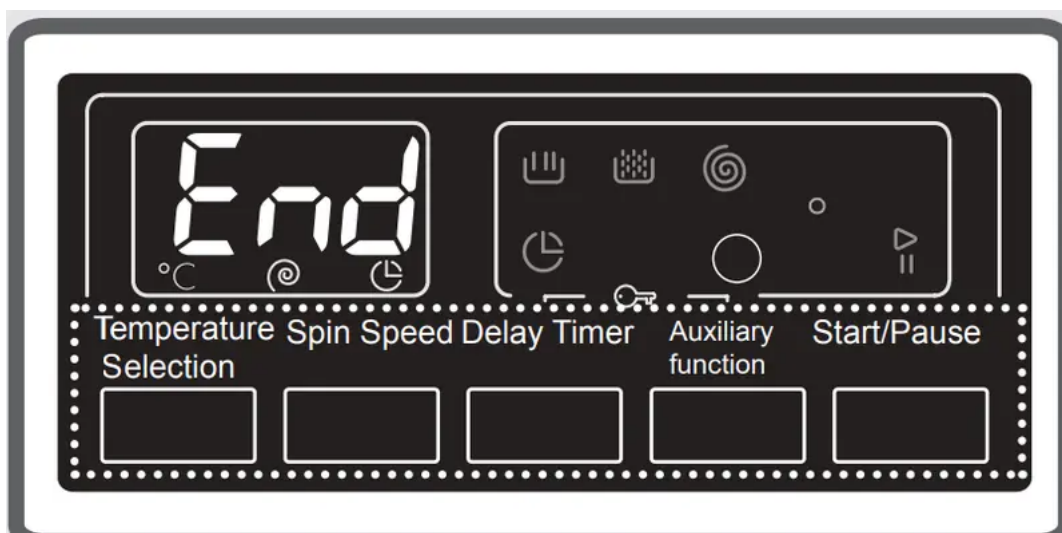

- You can open the machine's door and remove the laundry.
- Leave the door of your machine open to allow the inner part of your machine to dry after removing your laundries.

- Switch the programme knob to position “O”.
- Unplug your machine.
- Turn the water faucet off.

## MAINTENANCE AND CLEANING

### WARNING

- Unplug your machine before starting the maintenance and cleaning of your machine.
- Turn the tap water off before starting the maintenance and cleaning of your machine.

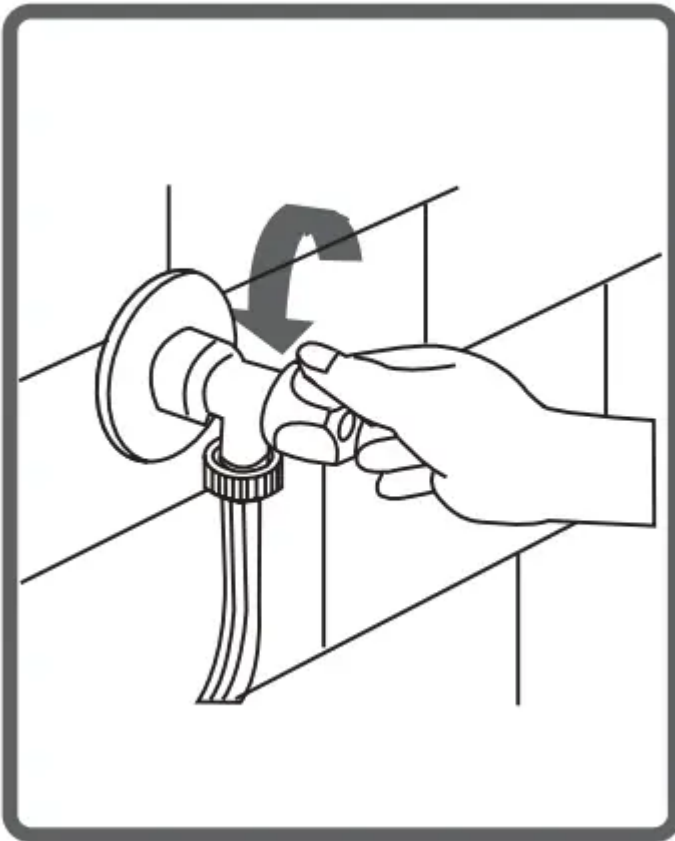

**CAUTION:** Your machine's parts might be damaged if cleaners with solvent agents are used.

Do not use cleaning materials with solvent agents.

### WATER INLET FILTERS

Filters to avoid dirt and foreign substances in the water from penetrating into the machine are available both on the side of faucet and on the ends of water valves along the water inlet hose of your machine.

If your machine cannot intake sufficient amount of water despite water faucet being open, these filters should be cleaned.

It is recommended that you clean your pump filter once in 2 months.)

- Detach the water inlet hoses.
- Remove the filters on water inlet valves using pliers and then clean it with a brush in water.
- Disassemble the filters on the side of faucet side of water inlet hoses manually and clean it.
- Having the filters cleaned, you can fit them in the same way reversely.

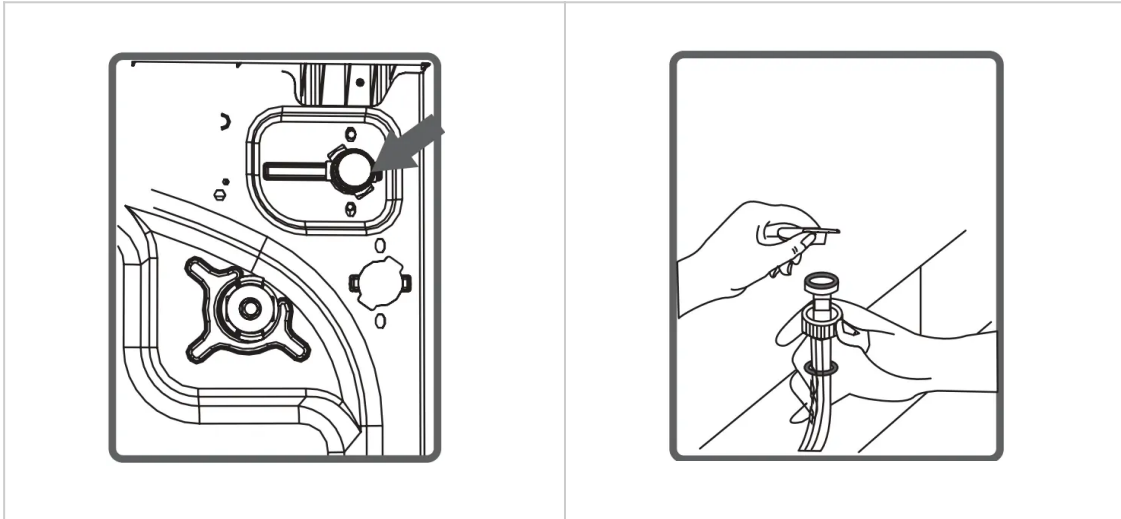

**CAUTION:**

- Filters of water inlet valves may be clogged due to contaminated water faucet or lack of necessary maintenance or valves may be broken down, causing water leaking into your machine continuously.
- The breakdowns that may arise due to these reasons are out of the scope of warranty.

**PUMP FILTER**

A filter system which avoids threads remaining from your laundries and tiny materials from entering into the pump during water discharging operation carried out by your machine after completing washing so prolonging the lifecycle of your pump is available. It is recommended that you clean your pump filter once in 2 months. To clean pump filter:

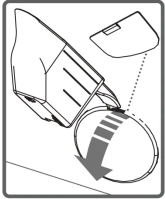
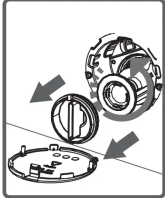
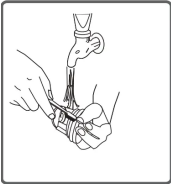
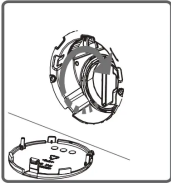
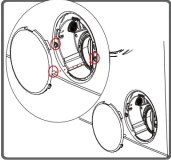
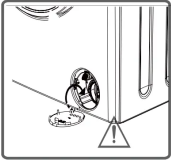

<ul style="list-style-type: none"> <li>• To open the pump cover, you can use the powder detergent spade (*) or liquid detergent level plate coming out of your machine.</li> <li>• Fit the end point of the plastic part to the gap of the pump cover and push it back. This will open the cover.</li> </ul>	
<ul style="list-style-type: none"> <li>• Before opening the filter cover, settle a vessel in front of the filter cover to prevent the water remained in the machine from flowing on the ground.</li> <li>• Loosen the filter cover in counter-clockwise and then empty water.</li> <li>• <b>Note:</b> You may have to empty the water collection vessel several times according to the amount of water in the machine.</li> </ul>	
<ul style="list-style-type: none"> <li>• Clean the foreign materials in the filter with a brush.</li> </ul>	
<ul style="list-style-type: none"> <li>• After cleaning the filter, fit the filter cover and tighten it by rotating it in clockwise direction.</li> </ul>	
<ul style="list-style-type: none"> <li>• While closing the pump cover, ensure that the parts on the inner side of the cover to match the holes on the front panel side.</li> </ul>	
<ul style="list-style-type: none"> <li>• You can reattach the pump cover in the reverse order that you removed it.</li> </ul>	

**WARNING!** As water in the pump may be hot, wait until it cools down.

## DETERGENT DRAWER

Your detergents may deposit residue in detergent drawer and housing of detergent drawer over time.

To clean the residue formed, disassemble the detergent drawer in particular periods. It is recommended that you clean your pump filter every 2 months.

To eject the detergent drawer:

- Pull the detergent drawer up to the end
- Keep on pulling by depressing on the section shown below in the detergent drawer and keep pulling and then unsettle the detergent drawer.

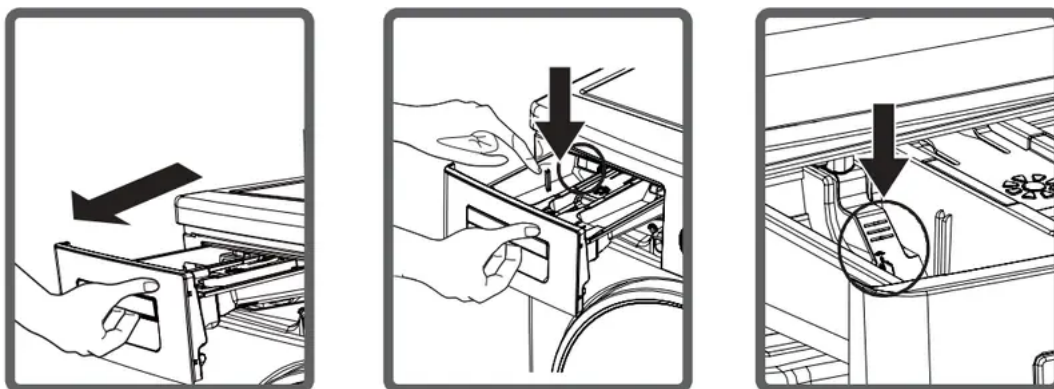

- Flush it using a brush.
- Collect residues in the housing of the detergent drawer without dropping them inside the machine.
- Assemble the detergent drawer after drying it using a towel or dry cloth.
- **Do not wash your detergent drawer in dishwasher.**

## Liquid Detergent Apparatus (\*)

Take out the liquid detergent level apparatus for cleaning and maintenance purposes as shown in the picture and clean well detergent residues. Put the apparatus back into its place. Make sure no residues are left inside.

(\*)Machinery specifications may vary depending on the product purchased.

## FLUSH STOPPER / BODY / DRUM

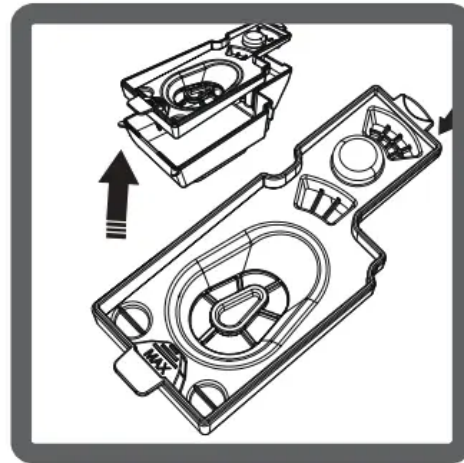
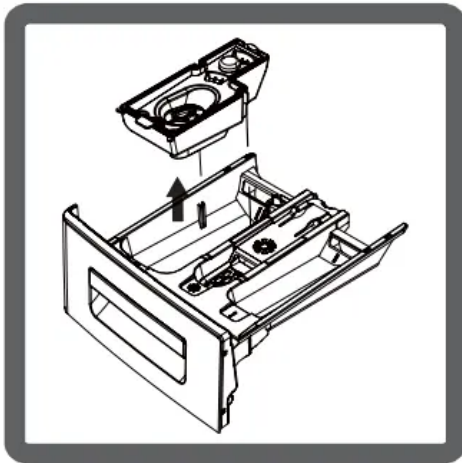

### Flush stopper

Disassemble the detergent drawer. Disassemble the flush stopper and clean the softener residues completely. Refit the flush stopper after cleaning it. Check whether it has settled properly

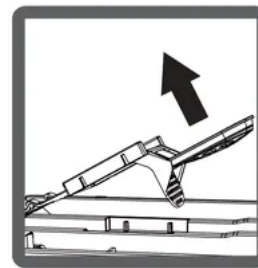

### Body

Clean the outer body of your machine with warm water and a non-inflammable cleaning agent that will not abrade the body of your machine. After rinsing with some water, dry it using a soft and dry cloth.

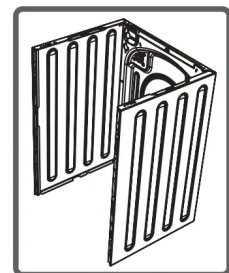

### Drum

Do not leave metallic objects such as needles, paper clips, coins etc. in your machine. This objects lead to formation of rust stains in the drum. To clean such rust stains, use a nonchlorine cleaning agent and follow the instructions of manufacturers of the cleaning agent. Never use wire wool or similar hard objects for cleaning rust stains.

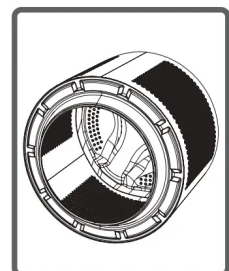

## TROUBLESHOOTING

All repairing operations required for your machine should be carried out by our authorised service. If your machine requires a repair or if you cannot remove the fault by the help of the information provided as follows:

- Unplug your machine.
- Turn the water faucet off.

FAULT	POSSIBLE CAUSE	TROUBLESHOOTING
Your machine does not start.	It is not plugged.	Plug machine in.
	Fuses out of order.	Replace the fuses.
	Electricity cut-off.	Check mains power.
	Start/Pause button not pressed.	Press on Start/ Pause button.
	Programme dial 'stop' position.	Switch the programme button to the desired position.
	The machine door is not completely closed.	Close the machine door.
Your machine does not intake water.	Water tap is turned off.	Turn your faucet on.
	Water inlet hose may be twisted.	Check water inlet hose and untwist.
	Water inlet hose clogged.	Clean water inlet hose filters. (*)
	Valve inlet filter clogged.	Clean the valve inlet filters. (*)
	The machine door not completely closed.	Close the machine door.
Your machine does not discharge water.	Discharging hose clogged or twisted.	Check the discharging hose, then either clean or untwist.
	Pump filter clogged.	Clean the pump filter. (*)
	Laundries settled in the machine non-homogeneously.	Spread your laundry in the machine evenly.
Your machine vibrates.	The feet of your machine have not been adjusted.	Adjust the feet on your machine. (**)
		Disassemble the safety stays of your machine. (**)

FAULT	POSSIBLE CAUSE	TROUBLESHOOTING
	Safety stays fitted for transportation not disassembled.	
	Less amount of laundry in the appliance.	This will not block operation of your machine.
	Your machine is overloaded with laundry or laundry settled unevenly.	Do not put in laundry more than the amount recommended and settle the laundry in the machine evenly
	Your machine rests on a hard surface.	Prevent your machine from resting on hard surfaces.
Excessive foam is formed in the detergent drawer.	Excessive amount of detergent used.	Press on Start/Pause button. To eliminate foam formation, mix a spoon of softener with half litres of water, and pour the mixture in the detergent drawer. After 5-10 minutes, Press on Start/ Pause button again. In your next washing operation, Adjust the detergent dose accordingly.
	Wrong detergent used.	Use detergents produced only for automatic washing machines in your machine.
Unsatisfactory washing result.	The contamination degree of your laundries does not match the programme you have chosen.	Select the programme appropriate for the contamination degree of your laundries. (See programme table)

FAULT	POSSIBLE CAUSE	TROUBLESHOOTING
	Amount of detergent used insufficient.	Adjust the amount of detergent based on the amount and contamination degree of your laundries.
	Laundries in excess of maximum capacity put in your machine.	Load your machine with laundries, amount of which will not exceed maximum laundry capacity.
Unsatisfactory washing result.	Water being hard. (Contaminated, lime water etc.)	Adjust the amount of detergent based on the instruction of detergent manufacturer.
	Laundries distributed in your machine non-homogenously.	Spread your laundries in the machine properly and homogeneously.
As soon as the machine is loaded with water, water discharges.	The end of water discharging hose is too low for the machine.	Set the water discharging hose on appropriate height. (**)
No water appears in the drum during washing.	No fault. Water is in the unseen part of the drum.	<hr/>
Laundries have detergent residues on them.	Non-dissolving particles of some detergents may stick to your laundries as white spots.	Perform an Extra rinse by setting your machine to "Rinsing" programme, or clean the spots using a brush after your laundries dry.
Grey spots appear on the laundries.	The reason for such spots may be oil, cream or ointment.	Apply the maximum amount of detergent instructed by the detergent manufacturer in the next washing operation.

FAULT	POSSIBLE CAUSE	TROUBLESHOOTING
Spinning operation is not performed or runs late.	No fault. Unbalanced load control system has been activated.	<p>Unbalanced load control system will try to spread your laundries homogeneously.</p> <p>Spinning operation will begin after your laundry is spread. Place the laundry in the machine in a balanced fashion the next time.</p>

### **AUTOMATIC FAULT WARNINGS AND WHAT TO BE DONE**

Your machine is equipped with the systems which are capable of both taking necessary precautions and warning you in case of any breakdown by means of continuous self-checking during washing operations.



TROUBLE CODE	POSSIBLE FAULT	WHAT TO DO
E01	The door of your machine is left open.	Close the machine door. If your machine persists to indicate fault, turn off your machine, unplug it and contact the nearest authorised service immediately.
E02	The water pressure or the water level inside the machine is low.	Turn on the faucet. Mains water may be cut-off. If the problem still continues, your machine will stop after a while automatically. Unplug the machine, turn off your faucet and contact the nearest authorised service.
E03	The pump is faulty or pump filter is clogged or electrical connection of the pump is faulty.	Clean the pump filter. If the problem persists, contact the nearest authorised service. (*)
E04	Your machine has excessive amount of water.	Your machine will discharge water by itself. Pursuant to discharging operation, turn off your machine and unplug it. Turn off your faucet and contact the nearest authorised service.



## PRACTICAL INFORMATION



**Acoholic drinks:** Spotted area should initially be washed using cold water, and then be wiped with glycerine and water and rinsed with vinegar-mixed water.

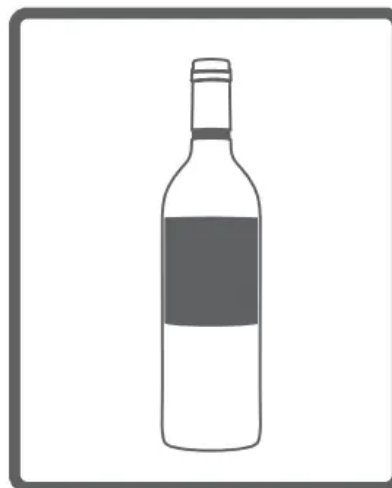

**Shoe shine:** Spot should be rubbed out gently without damaging the cloth and be scrubbed and rinsed with detergent. If not removed, it should be scrubbed using the mixture obtained by adding 1 scale of alcohol (96°) into 2 scales of water, and then be washed with warm water.



**Tea and coffee:** Stretch the spotted area of your laundry throughout the opening of a vessel, and pour hot water as much as the type of your laundry can resist.

In case the type of your laundry permits, wash with bleacher.



**Chocolate and cocoa:** After submerging your laundries in cold water and rubbing it using

soap or detergent, wash it in temperature that fabric type of your laundry can resist. In case the oil stain is still visible, wipe with oxygen water (3%).



**Tomato paste:** After rubbing out the dried substances without damaging your laundry, submerge it in water for 30 minutes, and then scrub and wash it with detergent.

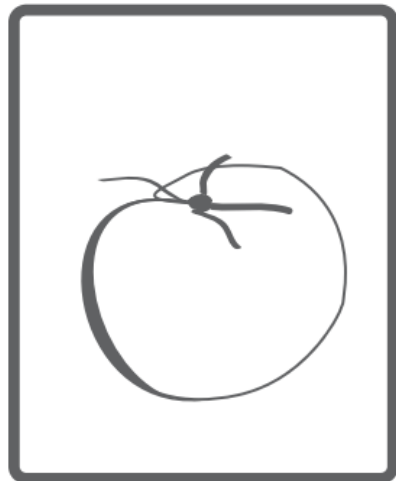

**Bouillon-Egg:** Remove dried spot residues on your laundry, and then wipe it with a sponge or soft cloth submerged in cold water previously. Scrub with detergent, wash with diluted bleacher.

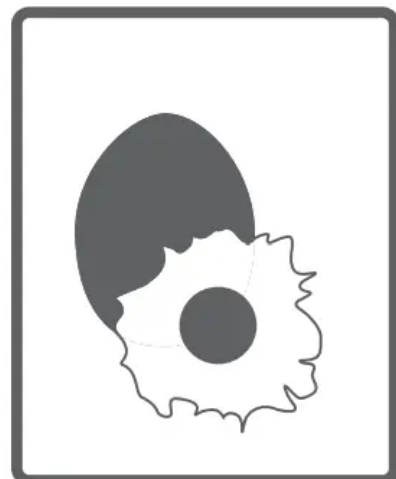

**Grease and oil stains:** Firstly, wipe the residues. Scrub the spot with detergent and wash it with warm soapy water.

**Mustard:** Apply glycerine on spotted area. Scrub with detergent and wash. If the spot cannot be removed, wipe with alcohol. (For synthetic and colour fabrics, a mixture of 1 scale of alcohol and 2 scales of water should be used)

**Fruit:** Stretch the spotted area of your laundry throughout the opening of a vessel, and pour cold water on it. Do not pour hot water on the spot. Wipe with cold water and apply glycerine. Allow 1-2 hours, wipe with a few drops of white vinegar, and rinse it.

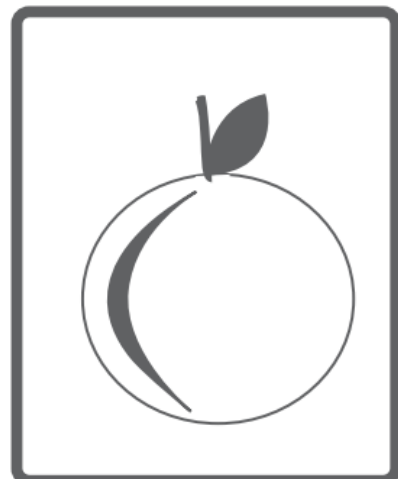
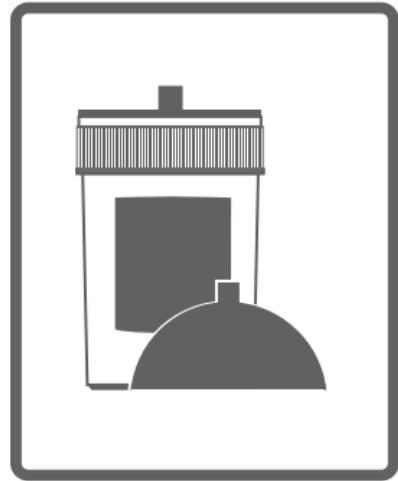

**Grass stain:** Wipe the stained part with detergent. If the type of your cloth permits bleacher using, wash with bleacher. Wipe your woollen laundries with alcohol. (For colour fabrics, a mixture of 1 scale of pure alcohol and 2 scales of water)



**Oil paint:** Spot should be removed by applying thinner before drying. Then it should be wiped with detergent and washed.



**Burn stain:** If your laundry is suitable for applying bleacher, you can add bleacher into washing water. For wool fabric, a cloth previously submerged in oxygen water should be covered over the stain and it should be ironed after putting a dry cloth on this cloth. It should be washed after being rinsed properly.



**Blood stain:** Submerge your laundries in cold water for 30 minutes. If the stain is not

removed, then submerge in a mixture of water and ammoniac (3 spoons of ammoniac in 4 litres of water) for 30 minutes.



**Crema, ice cream and milk:** Submerge your laundries in cold water and scrub the spotted area with detergent. If the spot is not removed, apply bleach to the extent suitable for your laundries. (Do not use bleach for colour laundries.)



**Muff:** Muff stains should be cleaned as soon as possible. Stain should be washed with detergent water, nevertheless if it cannot be removed, it should be wiped with oxygen water (3%).



**Ink:** Subject the spotted area to running water and wait until the flow of inked water ends. Then wipe it with lemon-added water and

detergent, and wash it after allowing 5 minutes.

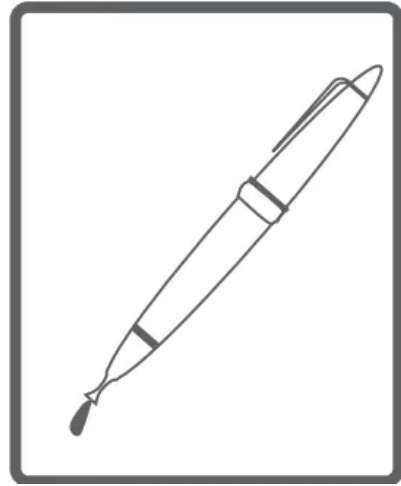

### **Warning**

This content is compiled from multiple sources and is provided for reference purposes only. It may not be complete or fully applicable to all situations. If you are unable to resolve your issue, please contact the product manufacturer or an authorized service provider for official support.