

PRODUCT OVERVIEW

Parts

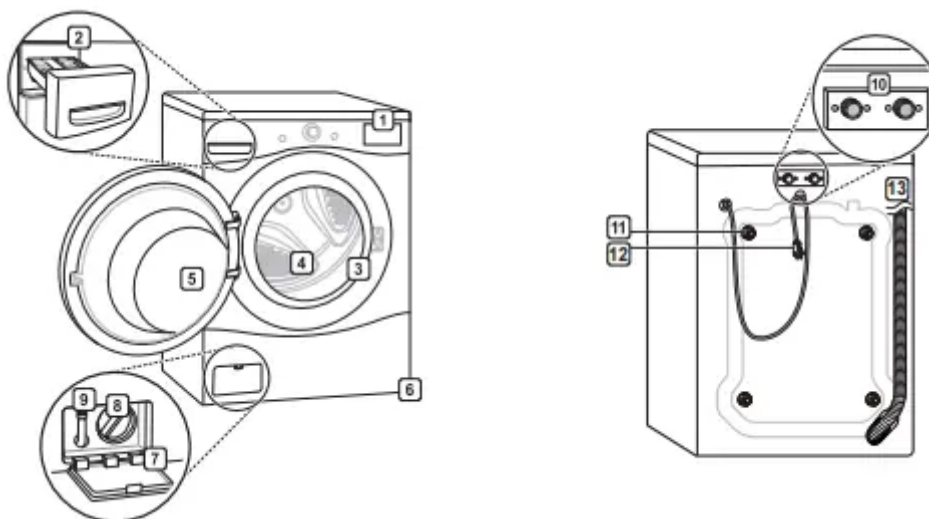

- 1 Control Panel
- 2 Detergent Dispenser Drawer
- 3 Door Seal
- 4 Drum
- 5 Door
- 6 Leveling Feet
- 7 Drain Pump Filter Cover
- 8 Drain Pump Filter
- 9 Drain Hose
- 10 Water Inlets
- 11 Shipping Bolts
- 12 Power Cord
- 13 Drain Hose

Accessories

Included Accessories



Non-skid pads



Hole caps (4)



Wrench



Tie strap



Elbow bracket
(for securing drain
hose)

Required Accessories



Hot/cold water hoses
(sold separately)

Optional Accessories



Pedestal or Pedestal washer
(sold separately)

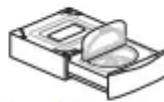

Stacking Kit
(sold separately)

NOTE

- The images in this guide may be different from the actual components and accessories, which are subject to change by the manufacturer without prior notice for product improvement purposes.
- For your safety and for extended product life, use only authorized components. The manufacturer is not responsible for product malfunction or accidents caused by the use of separately purchased unauthorized components or parts.

INSTALLATION

Tools Needed



Pliers



Level

Installation: Please read the following installation instructions first after purchasing this product or transporting it to another Overview location.



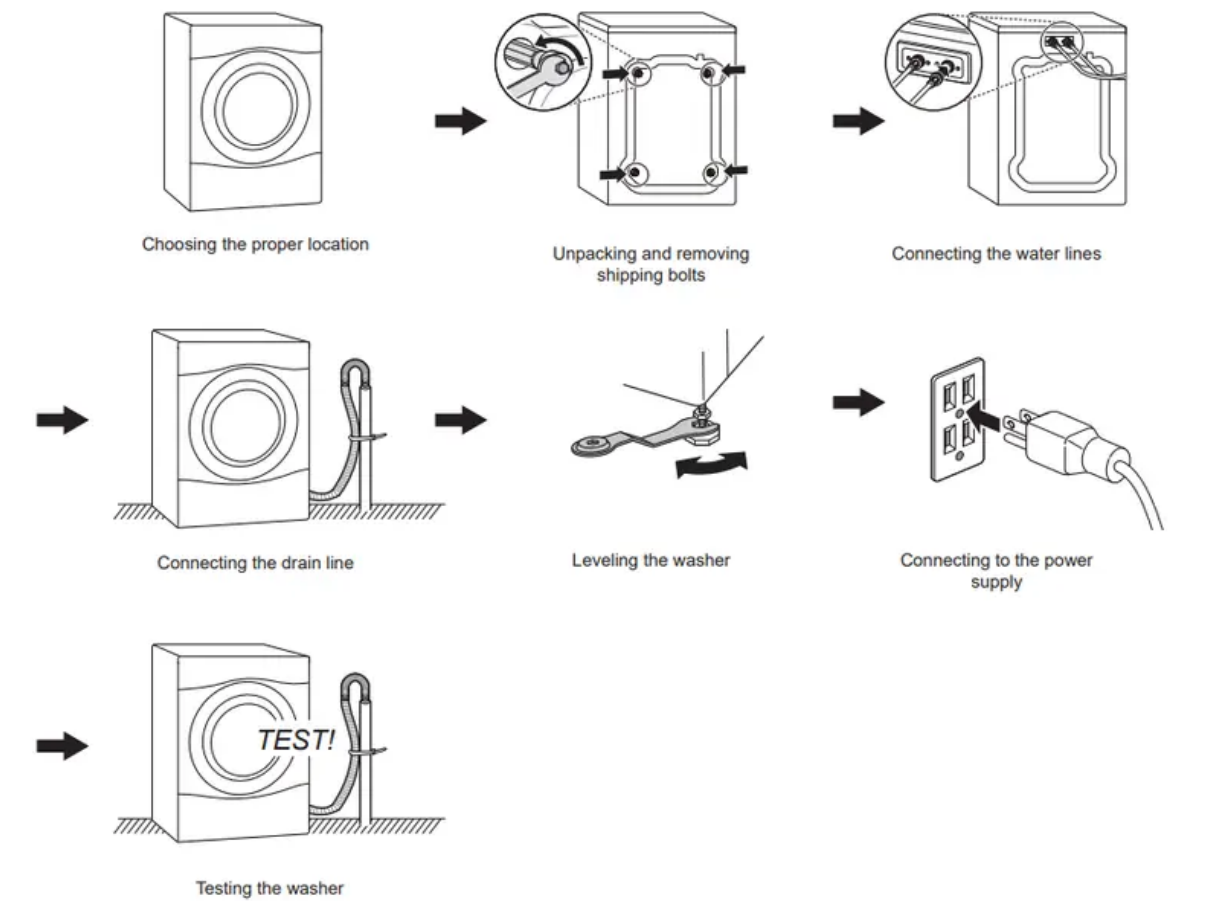

Product Specifications

The appearance and specifications listed in this manual may vary due to constant product improvements.

- Electrical requirements: 120 VAC @ 60 Hz
- Min. | Max. water pressure: 20 ~ 120 psi (138-827 kPa)
- Dimensions
 - 70 cm(W) X 77 cm(D) X 99 cm(H). 139.6 cm (D with door open)
 - 27"(W) X 30"(D) X 39"(H). 55" (D with door open)
- Net weight: 187.4 lb (85 kg)
- Max spin speed: 1300 RPM

WARNING

- Moving or installation of the appliance requires two or more people. Failure to follow these instructions may result in injury.

- Store and install the appliance where it will not be exposed to temperatures below freezing or exposed to outdoor weather conditions. Failure to follow this warning can cause product or part failure. serious injury, fire,electric shock,or death.
- Properly ground the washer to conform with all governing codes and ordinances. Failure to follow this warning can cause serious injury,fire,electric shock,or death.
- To reduce the risk of electric shock,do not install the appliance in humid spaces. Failure to follow this warning can cause serious injury,fire,electric shock,or death.
- To ensure proper airflow,do not block the large opening on the bottom of the washer with carpeting or other materials.
- Do not remove the ground prong. Do not use an adapter or extension cord. Plug into a grounded 3-prong outlet. Failure to follow this warning can cause serious injury,fire,electric shock. or death.
- Certain internal parts are intentionally not grounded and may present a risk of electric shock only during servicing. Service personnel - Do not contact the following parts while the appliance is energized: pump, valve, motor, control board.

Choosing the Proper Location

Install the washer on a solid floor that is strong and rigid enough to support the weight of the washer. even when fully loaded,without flexing or bouncing. If the floor has too much flex,you may need to reinforce it to make it more rigid,Ifthe floor is not solid,it may cause severe vibration and noise.

NOTE

- Before installing the washer. make sure the floor is clean. dry and free of dust,dirt,water and oil so the washer feet cannot slide easily. Leveling feet that can move or slide on the floor can contribute to excess vibration and noise due to poor contact with the floor.
- If a drip pan must be used,take extra care to follow the instructions provided with the drip pan and make sure the leveling feet are adjusted for firm and even contact with the pan. Use of drip pans and failure to properly level the machine may result in increased vibration and noise during operation.
- Allow for sufficient space between the walls and the washer for installation.

Power Outlet

- The power outlet must be within 60 inches (1.5 m) of either side of the washer.
- The appliance and outlet must be positioned so that the plug is easily accessible.
- Do not overload the outlet with more than one appliance.
- The outlet must be grounded in accordance with current electrical wiring codes and regulations.

- Use a time-delay fuse or circuit breaker.

NOTE

- Its the personal responsibility and obligation of the product owner to have a proper outlet installed by qualified service personnel

Flooring

- To minimize noise and vibration. the washer must be installed on a solidly constructed floor.
- Allowable slope under the entire washer is a maximum 1 inch (2.5 cm) difference from side to side or from front to back.
- Installing on carpeting and soft tile surfaces is not recommended.
- Never install the washer on a platform or weakly supported structure.

NOTE: The washer must be installed on firm flooring to minimize vibration during the spin cycle. Concrete flooring is best, but a wood floor is sufficient, provided it is built to FHA standards.

Floor Installation

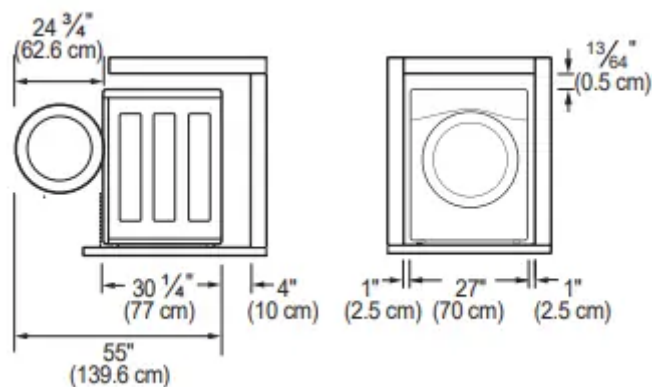

To ensure sufficient clearance for water lines. the drain line and airflow, allow minimum clearances of atleast 1 inch (2.5 cm) at the sides and 4 inches (10 om) behind the unit. Be sure to allow for wall. door.

F floor moldings that may increase the required clearances.

Stacked or Pedestal Installation

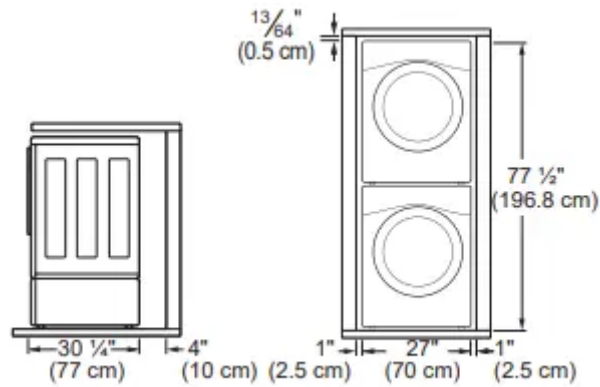

NOTE

- Refer to the instructions packaged with the optional pedestal kit before installing with a pedestal kit.
- Do not use a drip pan with a pedestal or pedestal washer installation as it can block the drawer. Using a drip pan may result in increased vibration and noise during operation.

Unpacking and Removing Shipping Bolts

Unpack all shipping materials from the washer for proper operation and inspect it for shipping damage.

CAUTION: Failure to remove shipping materials can cause excessive noise and vibration.

1. Lift the washer off the foam base. After removing the carton and shipping material, lift the washer off the foam base. Make sure the plastic tub support comes off with the base and is not stuck to the bottom of the washer. If you must lay the washer down to remove the base packaging materials, always protect the side of the washer and lay it carefully on its

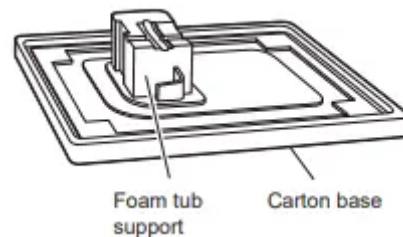

side. Do not lay the washer on its front or back.

2. Remove the bolt assemblies. Starting with the bottom two shipping bolts, use the wrench (included) to fully loosen all four shipping bolts by turning them counterclockwise.



Remove the bolt assemblies by wiggling them slightly while pulling them out.

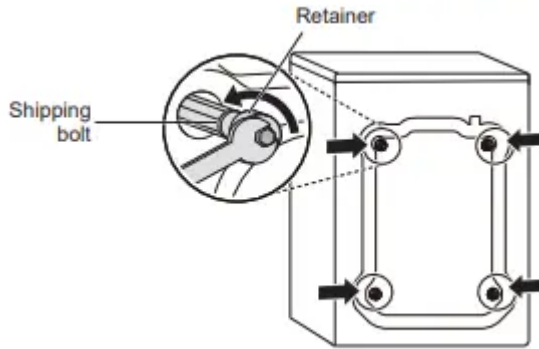

3. Install the hole caps. Locate the four hole caps included in the accessory pack and install

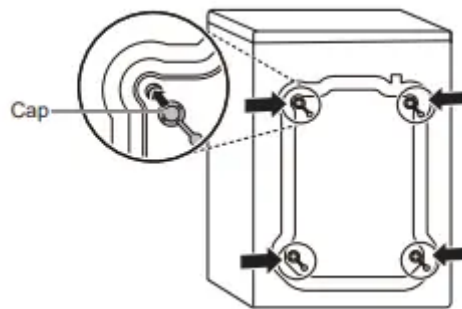

them in the shipping bolt holes.

NOTE

- Save the bolt assemblies for future use. To prevent damage to internal components, do not transport the washer without reinstalling the shipping bolts.
- Failure to remove shipping bolts and retainers may cause severe vibration and noise, which can lead to permanent damage to the washer. The cord is secured to the back of the washer with a shipping bolt to help prevent operation with shipping bolts in place.

Connecting the Water Lines

To avoid the risk of costly water damage, purchase and install new inlet hoses when installing the washer

1. Check the fitting and seals. Inspect the threaded fitting on each hose and make sure there is a rubber seal in place in both ends of each hose to prevent leaking.

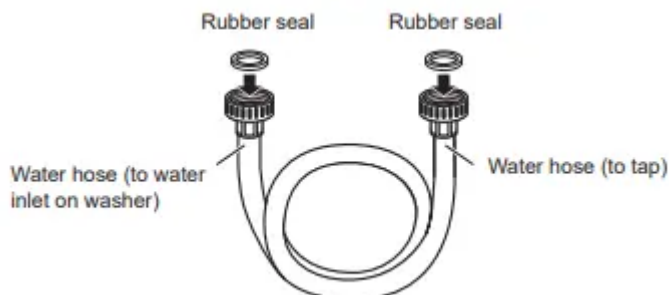

2. Connect the water supply hoses. Connect the water supply hoses to the hot and cold water faucets tightly by hand and then tighten another 2/3 turn with pliers. Connect the blue hose to a cold water faucet and the red hose to a hot water faucet.

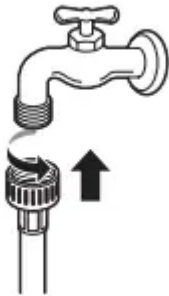

3. Flush out the inlet hoses. After connecting the inlet hoses to the water faucets, turn on the water to flush out foreign substances (dirt, sand or sawdust) in the water lines. Let water drain into a bucket, and check the water temperature to make sure you've



connected the hoses to the correct faucets.

4. Attach the water lines to the back of the washer. Attach the hot water line to the hot water inlet on the back of the washer. Attach the cold water line to the cold water inlet on the back of the washer. Tighten the fitting securely. Turn on both faucets all the way and

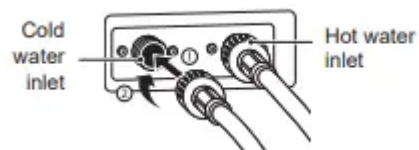

check for leaks at both ends of the hoses

WARNING

- Do not overtighten the hoses or cross-thread the can damage the hose fittings. Overtightening or cross-threading valves or couplings, resulting in leaking and property damage.
- Do not reuse old hoses. Use only new hoses when installing the washer. Old hoses could leak or burst causing flooding and property damage. Contact an LG Customer Information Center for assistance in buying hoses.

NOTE

- Periodically check the hoses for cracks, leaks, and wear, and replace the hoses every five years. Do not stretch the water hoses intentionally, and make sure that they are not pinched, crushed or kinked by other objects.
- Water supply pressure must be between 20 psi and 120 psi (138 – 827 kPa). If the water supply pressure is more than 120 psi, a pressure reducing valve must be installed.
- To provide optimum washing performance, the hot water temperature should be set at 120 – 130 °F (48 – 54 °C) and the cold at 60 °F (15 °C).
- The washer should never be installed or stored in a location subject to freezing temperatures. Damage to the water lines and internal mechanisms of the washer can result. If the washer was exposed to freezing temperatures prior to installation, allow it to stand at room temperature for several hours before use and check for leaks prior to operation.
- Do not use flood - preventing hoses with auto shutoff devices. The devices can be tripped during fill all prevent the machine from filling properly.

Connecting the Drain Hose

Connect the drain hose to either a standpipe or laundry tub.

NOTE

- The drain hose should always be properly secured. Failure to properly secure the drain hose can result in flooding and property damage.
- The drain must be installed in accordance with any applicable local codes and regulations.
- Make sure that the drain hose is not stretched, pinched, crushed, or kinked.
- Do not install the drain hose with the end lower than 29.5 inches (0.7 m) or higher than 96 inches (2.4 m) above the bottom of the washer or more than 60 inches (1.5 m) away from the washer.
- Never create an airtight seal between the hose and the drain with tape or other means. If no air gap is present, water can be siphoned out of the tub resulting in poor wash/rinse performance or clothing damage.

Option 1: Standpipe

1. Clip the end of the hose into the elbow bracket. Connect the elbow bracket within 4 inches (10 cm) of the end of the drain hose. If the drain hose is extended more than 4

inches (10 cm) beyond the end of the elbow bracket, mold or microorganisms could

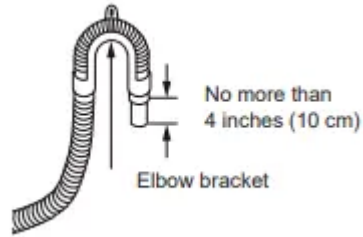

spread to the inside of the washer.

2. Insert the end of the drain hose into the standpipe.

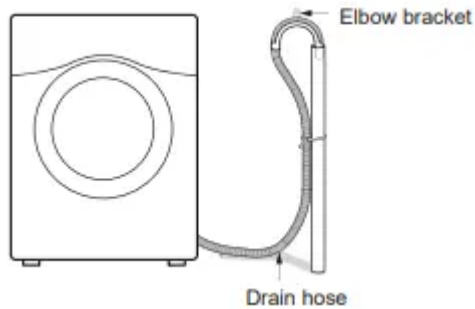

3. Use a tie strap to secure the drain hose in place.

Option 2: Laundry Tub

1. Clip the end of the hose into the elbow bracket. Connect the elbow bracket within 4 inches (10 cm) of the end of the drain hose. If the drain hose is extended more than 4 inches (10 cm) beyond the end of the elbow bracket, mold or microorganisms could

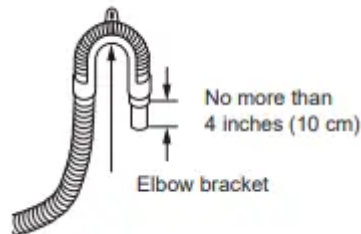

spread to the inside of the washer.

2. Hang the end of the drain hose over the side of the laundry tub.

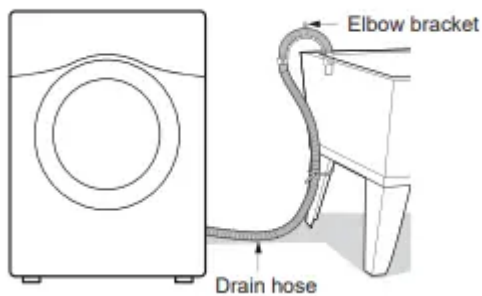

3. Use a tie strap to secure the drain hose in place.

Leveling the Washer

The drum of your new washer spins at very high speeds. To minimize vibration, noise, and unwanted movement, the floor must be a level, solid surface.

NOTE

- Adjust the leveling feet only as far as necessary to level the washer. Extending the leveling feet more than necessary can cause the washer to vibrate.
 - Before installing the washer, make sure that the floor is clean, dry and free of dust, dirt, water and oil so the washer feet cannot slide easily. Feet that move or side on the floor can contribute to excessive vibration and noise due to poor contact
1. Position the washer in its final location: Take special care not to pinch, strain, or crush the water and drain lines. If you have a carpenter's level, you can place it across the top of the washer. The slope beneath the washer should not exceed 1 inch, and all four

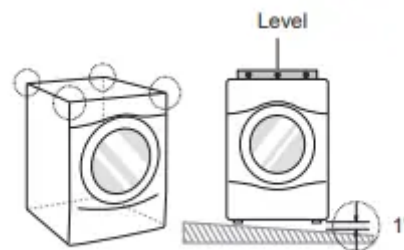

leveling feet must rest firmly on the floor

2. Adjust the lower leveling feet: Turn in one direction to raise the washer or the other

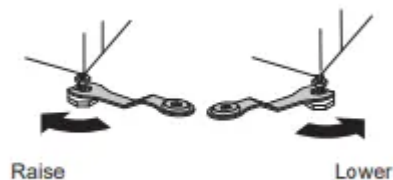

direction to lower it.

3. Tighten the locknuts. Turn the locknuts counter-clockwise and tighten them when the

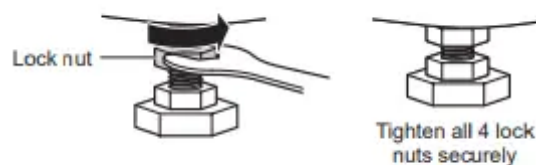

washer is level.

4. Recheck the washer's levelness. Push or rock the top edges of the washer gently to make sure the washer does not rock. If the washer rocks, repeat steps 1-3.

CAUTION

- Using the washer without leveling it may cause excess vibration and noise, leading to a machine malfunction.

- Extend the leveling feet only to level the washer. If you extend the leveling feet unnecessarily, it may cause abnormal vibration of the washer.

Using Non-Skid Pads: If you install the washer on a slippery surface, it may move because of excessive vibration. Incorrect leveling may cause malfunction through noise and vibration. If this occurs, install the non-skid pads under the leveling feet and adjust the level.

1. Clean the floor to attach the non-skid pads. Use a dry rag to remove and clean foreign objects or moisture. If moisture remains, the non-skid pads may slip.
2. Adjust the level after placing the washer in the installation area
3. Place the adhesive side of the non-skid pad on the floor. It is most effective to install the non-skid pads under the front leveling feet. If it is hard to place the pads under the front leveling feet, place them under the back leveling feet

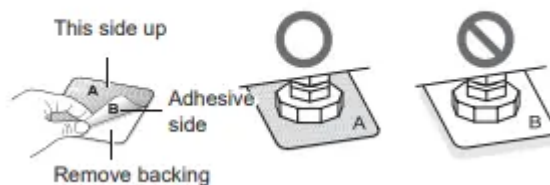

4. Recheck the washer's levelness. Push or rock the top edges of the washer gently to make sure that the washer does not rock. If the washer rocks, level the washer again.

Connecting to the Power Supply

The washer should be plugged into a 120-VAC, 60 Hz grounded 3-prong outlet. Plug in the washer.

WARNING

- Do not use a worn or damaged power cord or power plug. Replace or repair it immediately. Failure to do so may result in death, fire, electric shock, or malfunction.
- Do not modify the power cord and plug provided with the appliance. Take care not to damage it when installing or moving the washer. Failure to do so may result in death, fire, electric shock, or malfunction.
- Make sure that the washer is grounded.
- Connect this washer to a grounded outlet conforming to the rating prior to use. Failure to do so may result in fire, electric shock, or malfunction.
- Do not damage or cut off the ground prong of the power cord. Doing so may cause death, fire, electric shock, or product malfunction.
- Improper connection of the equipment-grounding conductor can result in risk of electric shock. Check with a qualified electrician or service technician if you are in doubt as to

whether the appliance is properly grounded. If it does not fit the outlet, have a proper outlet installed by a qualified electrician

- The appliance and outlet must be positioned so that the plug is easily accessible.
- Do not use adapters or extension cords. Doing so may result in serious injury, fire, electric shock, or death.
- For best performance, plug the washer into its own individual outlet. This helps prevent overloading house wiring circuits which could cause a fire hazard from overheated wires.
- If necessary, use a new, UL-listed 3-prong adapter or 3-wire extension cord with a 3-prong (grounding) plug rated at no less than the branch circuit. Do not use an extension cord longer than 3 feet. Failure to follow these warnings may result in serious injury, fire, electric shock, or death.

Testing the Washer

Check if the washer is properly installed and run a test cycle.

1. Load the washer with 6 pounds of laundry (approximately 6 thick bath towels).
2. Press the Power button.
3. Press the Rinse+Spin button.
4. Press the Start/Pause button. The wash cycle starts.
5. Check if water is supplied, that the machine does not rock or vibrate excessively, and that it drains well during the spin cycle.

NOTE

- If water leaks during water supply, see [Connecting the Water Lines](#) to connect them properly.
- If the washer rocks and vibrates excessively, see [Leveling the Washer](#) to level it again.
- If the drain does not work, see [Connecting the Drain Hose](#) to install the hose properly

OPERATION

Using the Washer

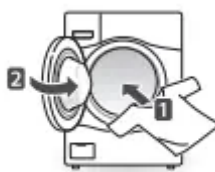

Sort Laundry and Load the Washer Sort laundry by fabric type, soil level, color and load size, as needed. Open the door and load items into the washer. If using detergent pods, place pod in drum before loading laundry.



Add Cleaning Products. Add the proper amount of HE (High - Efficiency) detergent to the detergent dispenser. If desired, add bleach or fabric softener to the appropriate areas of the dispenser drawer. Do not place liquid or powdered detergent pods in the dispenser.



Turn on the Washer: Press the Power button to turn on the washer. The lights above the cycle buttons will illuminate and a chime will sound.



Select a Cycle Turn the Cycle Selector Knob until the desired cycle is selected. The preset Temp., Spin, Soil and option settings for that cycle will be shown. Pressing the Start/Pause button without selecting a cycle will cause the Normal cycle to begin immediately.



Adjust Settings: Default settings for the selected cycle can now be changed, if desired, using the cycle modifier and option buttons. Not all modifiers and options are available on all cycles. A different chime will sound and the LED will not come on if the selection is not allowed.



Begin Cycle Press the Start/Pause button to begin the cycle. The washer will agitate briefly without water to measure the weight of the load. If the Start/Pause button is not pressed within 60 minutes, the washer will shut off and all settings will be lost.



End of Cycle: When the cycle is finished, a melody will sound. Immediately remove your clothing from the washer to reduce wrinkling. Check around the door seal when removing the load for small items that may be caught in the seal.

NOTE

- The washer rotates the laundry in a way that allows it to use less water while still fully saturating your clothing. It is normal to not be able to see water during the wash cycle.
- If the temperature or the water level inside the machine is too high, the door will not unlock when the Start/ Pause button is pressed. To open the door in these circumstances, press Add Garments. To stop a cycle and drain the water completely, turn the power off, then on, and then press Rinse+Spin.

Loading the Washer

- Check and empty pockets. Paper clips, coins, matches, etc. can damage clothing and the washer.
- Close zippers and hooks, and tie drawstrings to prevent snagging or tangling of clothes.
- Pretreat heavily stained areas for best results.
- Combine large and small items in a load. Load large items first. Large items should not be more than half of total load.
- The washer can be fully loaded, but the drum should not be tightly packed with items. The door of the washer must close easily.

- Do not wash single small items. Add 1-2 similar items to the load to prevent an out-of-balance load.
- Wash thick, bulky items individually. Heavy blankets, comforters, bedspreads, or pet beds can get tangled or cause an unbalanced load if combined with other items.
- Do not wash/spin waterproof items. Washing raincoats or sleeping bags may result in abnormal vibration or may cause the load to bounce, which could damage the drum.
- Wash small, light items in a mesh bag. Items like underwear can get caught in the door seal, and a brassiere hook may damage other items or the drum.
- Brush off heavy soil, dust, and hair from items before washing. Excess dirt or sand can abrade other fabrics and lead to poor wash performance.
- For best performance, load clothes as shown.

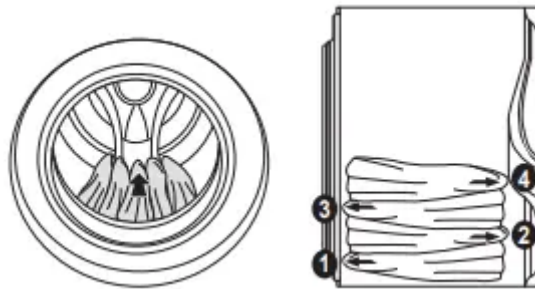

- Load clothes loosely, and do not overfill the drum. Clothes need room to circulate in order to get clean.
- Do not press down on items while stacking them in the drum.

Control Lock

- Use this option to disable the controls. This feature can prevent children from changing cycles or operating the machine. The feature does not lock the door. Once the Control Lock is set, it must be deactivated before any controls, except the Power button, can be used. Once the washer has shut off, the Power button will allow the machine to be turned on, but the controls will still be locked. When the controls are locked, will display

alternately  with the estimated time remaining.

Locking/Unlocking the Control Panel

- Press and hold the Control Lock button for 3 seconds.

NOTE

- Turning off the power will not reset the Control Lock function. You must deactivate Control Lock before you can access any other functions.

- When Control Lock is turned on, you cannot operate any buttons except the Power button.

Additional Operation Information



This manual contains an abbreviated Operation section. For the complete Operation section, scan the QR code below



- Sorting Laundry
- Adding Cleaning Products
- Control Panel
- Wash Cycles
- Cycle Guide
- Cycle modifier Buttons
- Option Buttons

SMART FUNCTIONS



For appliances with the  or  logo

LG ThinQ Application

The LG ThinQ application allows you to communicate with the appliance using a smartphone.

Before Using LG ThinQ

1. Use a smartphone to check the strength of the wireless router (Wi-Fi network) near the appliance. If the distance between the appliance and the wireless router is too far, the signal strength becomes weak. It may take a long time to register or installation may fail

2.

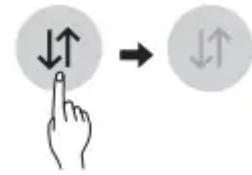

Turn off the Mobile data or Cellular Data on your smartphone.

3.



Connect your smartphone to the wireless router.

NOTE

•



To verify the Wi-Fi connection, check that Wi-Fi icon on the control panel is lit.

- The appliance supports 2.4 GHz Wi-Fi networks only. To check your network frequency, contact your Internet service provider or refer to your wireless router manual.
- LG ThinQ is not responsible for any network connection problems or any faults, malfunctions, or errors caused by network connection.
- The surrounding wireless environment can make the wireless network service run slowly
- If the appliance is having trouble connecting to the Wi-Fi network, it may be too far from the router. Purchase a Wi-Fi repeater (range extender) to improve the Wi-Fi signal strength.
- The network connection may not work properly depending on the Internet service provider.
- The Wi-Fi connection may not connect or may be interrupted because of the home network environment.
- If the appliance cannot be registered due to problems with the wireless signal transmission, unplug the appliance and wait about a minute before trying again.
- If the firewall on your wireless router is enabled, disable the firewall or add an exception to it.
- The wireless network name (SSID) should be a combination of English letters and numbers. (Do not use special characters.)
- Smartphone user interface (UI) may vary depending on the mobile operating system (OS) and the manufacturer.
- If the security protocol of the router is set to WEP, network setup may fail. Change the security protocol (WPA2 is recommended), and register the product again.

Installing the LG ThinQ Application

- Search for the LG ThinQ application from the Google Play Store or Apple App Store on a smart phone. Follow instructions to download and install the application.

LG ThinQ Application Features

- Washer Cycle (Remote Start, Downloaded): Set or download any preferred cycle and operate by remote control.
- Tub Clean Coach: This function shows how many cycles remain before it is time to run the Tub Clean cycle.
- Smart Diagnosis™ : This function provides useful information for diagnosing and solving issues with the appliance based on the pattern of use.
- Energy Monitoring: The washer energy usage is affected by the cycles and options so you may see some changes in energy usage from one cycle to another.
- Push Alerts: When the cycle is complete or the appliance has problems, you have the option of receiving push notifications on a smart phone.
- Settings: Set the product nickname and delete product.

NOTE

- If you change your wireless router, Internet service provider, or password, delete the registered appliance from the LG ThinQ application and register it again.
- This information is current at the time of publication. The application is subject to change for product improvement purposes without notice to users.

Using Washer Cycle

Remote Start: Use a smart phone to control the appliance remotely or check to see how much time is left in the cycle.

Using Remote Start

1. Press the Power button.
2. Load the laundry.
3. Press and hold Remote Start button for 3 seconds to enable the Remote Start function.
4. Start a cycle from the LG ThinQ application on your smart phone.

NOTE

- Once the Remote Start mode is enabled, you can start a cycle from the LG ThinQ smartphone application. If the cycle is not started, the machine will wait to start the cycle until it is turned off remotely from the application or the Remote Start mode is disabled.
- When Remote Start is turned on, the door is automatically locked.

Disabling Remote Start: When the Remote Start is activated, press and hold the Remote Start button for 3 seconds.

Downloaded

- Download new and specialized cycles that are not included in the standard cycles on the appliance.
- Appliances that have been successfully registered can download a variety of specialty cycles specific to the appliance.
- Only one cycle can be stored on the appliance at a time.
- Once cycle download is completed in the appliance, the appliance keeps the downloaded cycle until a new cycle is downloaded.

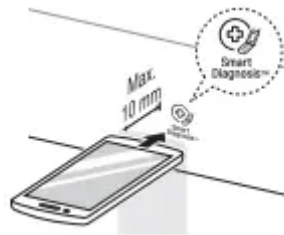

Smart Diagnosis™ Function

Should you experience any problems with the appliance, it has the capability of transmitting data via your telephone to the LG Customer Information Center. NFC or Wi-Fi equipped models can also transmit data to a smartphone using the LG ThinQ application



Smart Diagnosis™ through the Customer Information Center



For appliances with the  or  logo This method allows you to speak directly to our trained specialists. The specialist records the data transmitted from the appliance and uses it to analyze the issue, providing a fast and effective diagnosis.

1. Call the LG Electronics Customer Information Center
2. When instructed to do so by the call center, place the mouthpiece of the phone close to the Smart Diagnosis™ icon. Do not press any other buttons.
3. Press and hold Temp. for three seconds.
4. Keep the phone in place until the tone transmission has finished. For best results, do not move the phone while the tones are being transmitted. If the call center agent is not able to get an accurate recording of the data, you may be asked to try again.

5. Once the countdown is over and the tones have stopped, resume your conversation with the call center agent, who will then be able to assist you using the information transmitted for analysis.



NOTE

- Smart Diagnosis™ cannot be activated unless the appliance can be turned on using the Power button. If the appliance cannot be turned on, troubleshooting must be done without using Smart Diagnosis™.
- For best results, do not move the phone while the tones are being transmitted.
- If the call center agent is not able to get an accurate recording of the data, you may be asked to try again.
- The Smart Diagnosis™ function depends on the local call quality.
- Bad call quality may result in poor data transmission from your phone to the call center, which could cause Smart Diagnosis™ to malfunction.

LG ThinQ Smart Diagnosis™

-



For appliances with the  or  logo Use the Smart Diagnosis feature in the LG ThinQ application for help diagnosing issues with the appliance without the assistance of the LG Customer Information Center. Follow the instructions in the LG ThinQ application to perform a Smart Diagnosis using your smartphone.

- NOTE: Smart Diagnosis™ cannot be activated unless the appliance can be turned on using the Power button. If the appliance cannot be turned on, troubleshooting must be done without using Smart Diagnosis™.

MAINTENANCE

WARNING: TO reduce the risk of fire, electric shock, or injury to persons, read this entire owner's manual, including the Important Safety Instructions, before operating this washer.

- Unplug the washer before cleaning to avoid the risk of electric shock. Failure to follow this warning can cause serious injury, fire, electric shock, or death.
- Do not use volatile substances (benzene, paint thinner, alcohol, acetone, etc.), abrasive cleaners, or detergents with strong chemical components when cleaning the washer. Doing so may cause discoloration or damage to the machine, or may cause a fire

- Certain internal parts are intentionally not grounded and may present a risk of electric shock only during servicing. Service personnel - Do not contact the following parts while the appliance is energized: pump, valve, motor, control board.

Regular Cleaning

Care After Wash: After the cycle is finished, wipe the door and the inside of the door seal to remove any moisture.

- Leave the door open to dry the drum interior.
- Wipe the body of the washer with a dry cloth to remove any moisture.

Cleaning the Exterior: Proper care of your washer can extend its life.

- Door: Wash with a damp cloth on the outside and inside and then dry with a soft cloth.
- Exterior:
 - Immediately wipe off any spills.
 - Wipe with a damp cloth.
 - Do not touch the surface or the display with sharp objects.

Care and Cleaning of the Interior

- Use a towel or soft cloth to wipe around the washer door opening and door glass.
- Always remove items from the washer as soon as the cycle is complete. Leaving damp items in the washer can cause wrinkling, color transfer, and odor.
- Run the Tub Clean cycle once a month, or more often if needed, to remove detergent buildup and other residue

Cleaning the Drum: Over time, residue may build up in the drum, leading to mildew or a musty odor. Run the Tub Clean cycle monthly to remove residue and prevent odor. Run the cycle more often under heavy use conditions or if odor is already present

1. Remove any clothing from the drum.

2. Add cleaning agents

Cleaner

- Drum cleaner
- Lime scale remover
 - Add to main detergent compartment of detergent dispenser
- Liquid chlorine bleach: Add to bleach compartment of detergent dispenser
- Powdered cleaner: Pull out liquid detergent cup before adding to main detergent compartment
- Cleaning tablets: Place directly into washer drum

For other drum cleaning products, follow the cleaner manufacturer's instructions and recommendations.

Do not exceed the maximum fill line when adding bleach or powdered cleaners. Powdered detergent may remain in the drum after cleaning.

3. Close the door and press the Power button to turn the washer on.

4 Turn the cycle selector to select the Tub Clean cycle.

5. Press the Start/Pause button to begin the cycle. Selecting any other cycle after Tub Clean has been selected will cause the Tub Clean cycle to be cancelled.

6. After the cycle ends, open the door and allow the drum interior to dry completely.

NOTE

- Never load laundry while using Tub Clean. The laundry may be damaged or contaminated with cleaning products. Make sure to run the Tub Clean cycle only when the drum is empty.
- Leave the door open after finishing the laundry to keep the drum clean.
- Tub Clean should be repeated monthly.
- If mildew or musty smell already exists, run Tub Clean once a week for three consecutive weeks.

Automatic Alert for Tub Clean: When the power is on and the **ECL** message blinks on the display, it means the washer drum needs cleaning. Use the Tub Clean cycle to clean the washer drum. The frequency of the automatic alert's appearance depends on how often the washer is used, however the message will generally appear every one to two months.

Removing Mineral Buildup

In areas with hard water, mineral scale can form on internal components of the washer. Periodically clean the mineral buildup on the internal components to extend the lifespan of the washer.

- Use of a water softener is recommended in areas with hard water. Use a descaler to remove visible mineral buildup on the washer drum.

After descaling, always run the Tub Clean cycle before washing clothing.

- Mineral scale and other spots may be removed from the stainless steel drum using a soft cloth soaked in stainless steel cleaner.
- Do not use steel wool or abrasive cleaners

NOTE: If you use a descaler or tub cleaner during the Tub Clean cycle, use the Rinse+Spin cycle to rinse the washer drum before running your next wash cycle

Cleaning the Detergent Dispenser Drawer

Leaving detergent in the detergent dispenser drawer for an extended period of time or using the washing machine for a long period of time may cause the build-up of scales in the detergent dispenser drawer. Pull out and clean the detergent dispenser drawer once a week.

1. Slide the detergent dispenser drawer out as far as it will go.
2. Press down hard on the disengage button and pull out the detergent dispenser drawer.



3. Remove the inserts from the drawer.
4. Clean the inserts with warm water. Use a soft cloth or brush to remove any residue. Use water only when cleaning the drawer and inserts.
5. Wipe off any moisture with a dry towel or cloth after cleaning.
- 6.

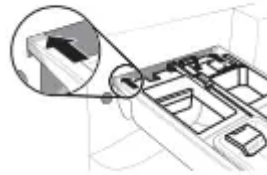

Replace the detergent dispenser drawe

WARNING: Do not spray water inside the cabinet. Doing so may cause fire or electric shock.

Cleaning the Door Seal

Clean the door seal once a month to prevent build-up of dirt.

1. Wear rubber gloves and protective goggles.
2. Dilute 3/4 cup (177 ml) of liquid chlorine bleach in 1 gallon (3.8 L) of water.
3. Wipe around the door seal. Soak a sponge or a soft cloth in this diluted solution and wipe all around the door seal.
4. Wipe dry. After cleaning, wipe up any moisture with a dry towel or cloth.
5. Leave the door open to allow the door seal to dry completely

CAUTION: Cleaning the door seal with undiluted bleach may cause malfunction of the door seal and washer parts. You must add water to the bleach before using it.

Cleaning the Water Inlet Filters

If the washer does not fill property, an error message will show on the display. The inlet valve filter screens could be plugged by hard water scale, sediment in the water supply, or other debris

CAUTION

- The inlet screens protect the delicate parts of the inlet valve from being damaged by particles that could enter the valves with the water supply. Operating the washer with these filters removed could cause a valve to stick open resulting in
- If you use the washer in an area with hard water, the inlet filter may clog due to lime buildup.

1 Turn off both water faucets completely.

2 Unscrew the hot and cold water hoses from the back of the washer.

3 Carefully remove the filters from the water valves.

4 Remove foreign objects and soak the filters in white vinegar or a lime scale remover. If using a lime scale remover, follow the manufacturer's instructions. Be careful not to damage the filters while cleaning them.

5 Rinse filters thoroughly and pree them back into place.

6 Flush then reattach the water hoses. Before reattaching the hoses, flush the hoses and water lines by running several gallons of water into a bucket or drain, preferably with the faucets

NOTE: An **IE** message may blink on the display when the water pressure is weak or an inlet filter is clogged with dirt. Clean the inlet filter.

Cleaning the Drain Pump Filter

The washer fails to drain if the drain pump filter is clogged. Periodically clean the drain filter to prevent Filter clogging with foreign objects.

1. Turn off the machine and unplug it.
- 2.

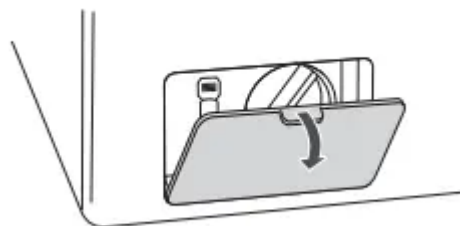

Open the drain pump filter cover

3. Drain any remaining water. Unclip the drain hose and remove the plug from the drain



hose to drain the remaining water.

4. Remove the pump filter. Twist the pump filter counterclockwise to remove

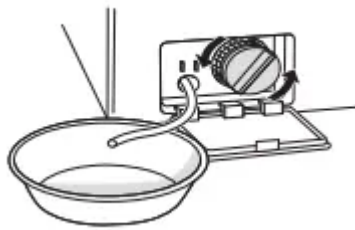

5.

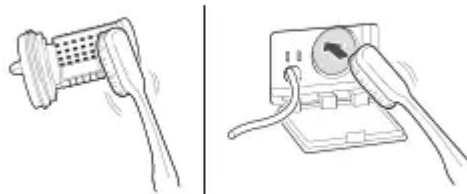

Clean the pump filter and opening

6. Recap the plug onto the drain hose and attach the drain hose.

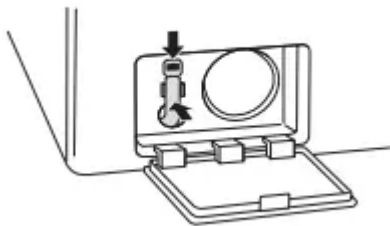

7.

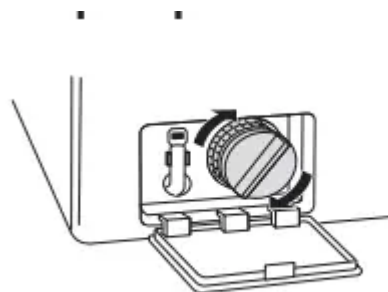

Insert the drain pump filter

8. Close the drain pump filter cover.



An **UE** message may blink on the display when the drain pump filter is clogged with dirt. Clean the drain pump filter.

Care in Cold Climates

Storing the Washer: If the washer will not be used for an extended period of time and is in an area that could be exposed to freezing temperatures, perform the following steps to protect the washer from damage.

1. Turn off the water supply.
2. Disconnect the hoses from the water supply and drain any water from the hoses.

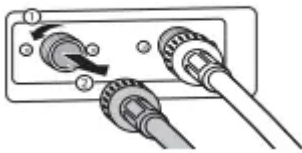

3. Plug the power cord into a properly grounded electrical outlet.
4. Add 1 gallon of nontoxic recreational vehicle (RV) antifreeze to the empty drum and close the door. Never use automotive antifreeze.
5. Press the Power button, then select Spin.
6. Press the Start/Pause button to start the drain pump.
7. Allow the drain pump to run for one minute, then press the Power button to shut off the washer. This will expel some of the antifreeze, leaving enough to protect the washer from damage.
8. Unplug the power cord, dry the drum interior with a soft cloth, and close the door.
9. Remove the inserts from the dispenser. Drain any water in the compartments and let them dry.
10. Store the washer in an upright position.
11. To remove the antifreeze from the washer after storage, run a complete Speed Wash cycle using detergent. Do not add laundry to this cycle.

When the Water Line is Frozen

1. Turn off the faucets connected to the water lines.
2. Pour hot water on the frozen faucets to thaw the water lines and remove them.
3. Immerse the water lines in hot water to thaw them.
4. Connect the water lines with the water inlets of the washer and with the faucets. See [Connecting the Water Lines](#) for details.
5. Turn on the faucets.

6. Press the Power button.
7. Press the Spin button.
8. Press the Start/Pause button. Verify the water fills properly

When the Drain Line is Frozen

1. Pour hot water in the washer drum and close the lid. Wait for 1-2 hours.
2. Press the Power button after thawing.
3. Press the Spin button to select draining and spinning.
4. Press the Start/Pause button. Check to make sure the water drains.

TROUBLESHOOTING

FAQs: Frequently Asked Questions

Why does my washer make loud banging noises while it is filling with water?

- This is actually a problem with the plumbing in your home. When the water valve in the washer shuts off, it can cause pipes in your home to move, resulting in a loud banging noise. This effect, called water hammer, can be reduced by installing an item called a water hammer arrestor. Add-on arrestors can be purchased through your local hardware or home improvement store.

Why is there so little water in my washer? How can it clean the clothes?

- HE (High-Efficiency) washers are designed to properly wash your laundry while using a minimum amount of water and energy. Because the water volume is low, the small amount of detergent used is more concentrated in the water, resulting in excellent cleaning performance.

When I press a button, why does my washer beep and then nothing happens?

- The Control Lock feature is turned on. To turn off Control Lock, turn the washer on, then press and hold the button that has "Control Lock" on or under it for three seconds.
- Power or Signal is off.

Where should I pour my powdered laundry products when doing my laundry?

- If you are using powdered laundry detergent, load it in the main detergent dispenser after removing the liquid detergent insert. Powdered laundry agents or powdered color safe bleach should be put directly into the tub. These products can be put in the empty tub before loading or on top of the laundry after loading the machine.

Before Calling for Service

The washer is equipped with an automatic error-monitoring system to detect and diagnose problems at an early stage. If the washer does not function properly or does not function at all, check the following before you call for service.

Noises You Might Hear

1. Spraying or Hissing

- Water spraying or circulating during the cycle. Normal Operation

2. Humming or Gurgling

- Drain pump is pumping water from the washer at times during a cycle. Normal Operation

3. Water sloshing

- A liquid in the balance ring around the wash basket helps the basket spin smoothly. Normal Operation

4. Water being added after the washer has already begun to operate

- The washer adapts to the load size and type to add more water to the cycle as needed.
- The wash load may be unbalanced. If the washer senses that the load is unbalanced, it will stop and refill to redistribute the load.
- The washer may be diluting laundry additives to add to the wash load

Normal Operation

5. Rattling and clanking noise

- Foreign objects, such as keys, coins, or safety pins may be in drum or pump. Stop washer, check drum and drain filter for foreign objects. If noise continues after washer is restarted, call for service.

6. Thumping sound

- Heavy wash loads may produce a thumping sound. This is normal. If sound continues, washer is probably out of balance. Stop and redistribute wash load.
- Wash load may be out of balance. Pause the cycle and redistribute the load.

7. Vibrating noise

- Packaging materials were not removed. See the Unpacking and Removing Shipping Bolts information in the Installation section.
- Wash load may be unevenly distributed in the drum. Pause the cycle and redistribute the load.
- Not all leveling feet are resting See Leveling the Washer in the Installation section.

- Floor not rigid enough. Make sure that the floor is solid and does not flex. See the Flooring in the Installation section.

8. Squeaking noise

- Packaging materials were not removed. See the Unpacking and Removing Shipping Bolts information in the Installation section.

9. Banging noise when washer is filling with water (Water Hammer)

- Plumbing in the home moves or flexes when the water valves in the washer shut off. Water hammer is not caused by a defect in the washer. Install water hammer arrestors (purchased separately at hardware or home improvement store) between the fill hose and the washer for best results.
- Household water supply pressure is very high. Adjust household water supply regulator to a lower pressure or contact a plumber.

Operation

1. Water leaking

- Inlet hose connection is loose at faucet or washer.
 - Check hoses for leaks, cracks and splits.
 - Check and tighten hose connections.
- House drain pipes are clogged. The washer pumps out water very rapidly. Check for water backing up out of the drain pipe during drain. If water is seen coming out of the drain, check for proper drain hose installation and check for restrictions in the drain. Contact a plumber to repair drain pipe
- Drain hose has come out of drain or is not inserted far enough. Tie drain hose to inlet hose or standpipe to prevent it from coming out during drain. For smaller drain pipes, insert the drain hose into the pipe as the drain hose flange. For larger drain pipes, insert the drain hose into the pipe 1 - 2 inches past the flange
- A large item such as a pillow or blanket is above the top of the drum.
 - Use the Bedding cycle for large or bulky items. Use extra care and never wash more than half a load of items that float, such as pillows.
 - Stop the washer and check the load. Make sure the load does not crest above the top edge of the drum.
- Oversudsing of detergent. Oversudsing may create leaks, and may be caused by the type and amount of detergent used. High - efficiency detergent is the only detergent recommended. The normal amount of detergent to use is 1/4 to 1/2 of the maximum amount recommended by the detergent manufacturer.

2. Water leaks every load

- Hoses not installed correctly. See Connecting the Water Lines to reinstall hoses. Replace damaged hoses

3. Washer will not drain water

- Kinked drain hose. Ensure that the drain hose is not kinked.
- Drain located improperly. Make sure that the drain hose is no more than 5 ft. (1.5 m) away from the washer

4. Excessive sudsing

- Too much detergent or incorrect detergent. HE detergents are formulated specifically for High - efficiency washers and contain suds - reducing agents. Only use detergent with the High - efficiency (HE) logo

5. Washer will not turn on

- Power cord is not properly plugged in. Make sure that the plug is plugged securely into a grounded, 3-prong, 120 VAC, 60 Hz outlet.
- House fuse is blown, circuit breaker has tripped, or power outage has occurred. Reset circuit breaker or replace fuse. Do not increase fuse capacity. If the problem is a circuit overload, have it corrected by a qualified electrician

6. Wash cycle time is longer than usual

- The washer automatically adjusts the wash time for the amount of laundry, water pressure and other operating conditions. This is normal. The washer adjusts cycle time automatically to provide optimal results for the selected cycle. The time remaining shown in the display is only an estimate. Actual time may vary

7. Bleach does not dispense

- Bleach dispenser cover is not properly installed. Make sure that the bleach cover is properly installed and snapped into place before the beginning of the cycle.
- Bleach dispenser is dirty or clogged. Lift out the bleach dispenser cover and clean out the reservoir. Lint and other foreign debris that collects inside the dispenser may prevent proper dispensing of the bleach.

8. Premature dispensing of bleach

- Bleach dispenser filled for future load. You cannot store bleach in the dispenser for future use. The bleach will be dispensed every load.
- Detergent compartments clogged from incorrect filling. Make sure that detergent and additives are put into the correct dispenser compartments. For all detergent types, always make sure that the dispenser drawer is fully closed before the start of the cycle

- Too much detergent used.
 - Make sure that the suggested amount of detergent is used per the manufacturer's recommendations. You may also dilute the detergent with water to the maximum fill line on the compartment to avoid clogging. Use only HE detergent
 - NOTE: Always use as little detergent as possible. High - efficiency washer need very little detergent to achieve optimum results. Using too much detergent will cause poor wash and rinse performance and may contribute to odors in washer.
- Insufficient water supply. Make sure that both hot and cold water faucets are turned on all the way.
- Normal residue. It is normal for a small amount of detergent to remain in the dispenser. If this residue builds up it can interfere with normal dispensing of products. Refer to the cleaning instructions.

9. Washer will not operate

- Control panel has powered off due to inactivity. This is normal. Press the Power button to turn the washer on.
- Washer is unplugged. Make sure cord is plugged securely into a working outlet.
- Water supply is turned off. Turn both hot and cold faucets fully on.
- Controls are not set properly. Make sure the cycle was set correctly, close the lid and press the Start/Pause button.

10. Washer will not operate

- Lid is open. The washer will not operate if the lid is open. Close the lid and make sure that nothing is caught under the lid preventing it from closing completely.
- Circuit breaker/fuse is tripped/ blown. Check house circuit breakers/fuses. Replace fuses or reset breaker. The washer should be on a dedicated branch circuit.
- Control needs to be reset. Press the Power button, then re-select the desired cycle and press the Start/Pause button.
- Start/Pause was not pressed after a cycle was set. Press the Power button then re-select the desired cycle and press the Start/Pause button. The washer will shut off if the Start/ Pause button is not pressed within 60 minutes.
- Extremely low water pressure. Check another faucet in the house to make sure that household water pressure is adequate.
- Washer is too cold.
 - If the washer has been exposed to temperatures below freezing for an extended period of time, allow it to warm up before pressing the Power button.

- Otherwise, the display will not come on.

11. Washer not filling properly

- Filter clogged. Make sure the inlet filters on the fill valves are not clogged. Refer to the filter cleaning instructions.
- Inlet hoses may be kinked. Check that inlet hoses are not kinked or clogged.
- Energy efficiency. This is an HE washer. As a result, the water level settings for this washer may be different than for conventional washers.
- Insufficient water supply. Make sure that both hot and cold water faucets are turned on all the way. The washer lid is open.
- The washer will not operate if the lid is open. Close the lid and make sure that nothing is caught under the lid preventing it from closing completely.

12. Water level is too low/ No water is visible in the drum

- Energy efficiency. This is HE washer. As a result, the water level settings for this washer may be different than on your previous washer. The water will not normally cover the clothes. The fill level is optimized for the wash motion to achieve the best wash performance.

Performance

1. Wrinkling

- Washer not unloaded promptly. Always remove items from the washer as soon as the cycle is complete.
- Washer overloaded. The washer can be fully loaded, but the drum should not be tightly packed with items. The lid of the washer should close easily.
- Hot and cold water inlet hoses are reversed. Hot water rinse can set wrinkles in garments. Check the inlet hose connections.

2. Staining

- Bleach or softener dispensed too soon. bleach or softener to dispense immediately. - one cup maximum. Dispenser drawer closed too quickly causing softener to dispense immediately.
- Bleach or softener was added directly to the wash load in the drum. Always use the dispensers to ensure that laundry products are properly dispensed at the right time in the cycle.
- Washer was not unloaded promptly. Always remove items from the washer as soon as possible after the cycle is complete.

- Clothes were not properly sorted. Always wash dark colors separately from light colors and whites to prevent discoloration. Never wash heavily soiled items with lightly soiled items

3. Poor stain removal

- Proper options not selected. Heavier soils and tougher stains may require extra cleaning power. Select the Heavy feature to boost the cleaning power of the selected cycle.
- Previously set stains. Articles that have previously been washed may have stains that have been set. These stains may be difficult to remove and may require hand washing or pre-treating to aid in stain removal.

4. Odor

- Some odor is caused by the rubber attached to the washing machine. This odor is normal for new rubber and will disappear after the machine has been run a few times.
- If the rubber door gasket and door seal area are not cleaned regularly, odors can occur from mold or foreign substances. Be sure to clean the gasket and door seal regularly and check under the door seal for small items when unloading the washer.
- Odors can occur if foreign substances are left in the drainage pump filter. Be sure to clean the drainage pump filter regularly.
- Odors can occur if the drainage hose is not properly installed, causing siphoning (water flowing back inside the washing machine). When installing the drainage hose, be sure that it doesn't become kinked or blocked.
- Using the dry function, odors can occur from lint and other laundry matter sticking to the heater. (Dryer model only) This is not a malfunction.
- A particular odor can occur from drying wet clothes with hot air. (Dryer model only) The odor will disappear after a short while.

Wi-Fi

1. Trouble connecting appliance and smartphone to Wi-Fi network

- The password for the Wi-Fi network was entered incorrectly. Delete your home Wi-Fi network and begin the registration process again.
- Mobile data for your smartphone is turned on. Turn off the Mobile data on your smartphone before registering the appliance.
- The wireless network name (SSID) is set incorrectly. The wireless network name (SSID) should be a combination of English letters and numbers. (Do not use special characters.)
- The router frequency is not 2.4 GHz. Only a 2.4 GHz router frequency is supported. Set the wireless router to 2.4 GHz and connect the appliance to the wireless router. To check the router frequency, check with your Internet service provider or the router manufacturer.

- The distance between the appliance and the router is too far. If the appliance is too far from the router, the signal may be weak and the connection may not be configured correctly. Move the router closer to the appliance or purchase and install a Wi-Fi repeater.

Error Codes

1. Washer fills with water slowly or not at all, or [IE]

- Water supply faucets are not fully open. Make sure that the water faucets are fully open.
- Water line hoses are kinked, pinched, or crushed. Make sure that the hoses are not kinked or pinched. Be careful when moving the washer during cleaning and maintenance.
- Water inlet filters are clogged. Clean the inlet filters. See the maintenance section.
- Water supply pressure to faucet or house is too low. Check another faucet in the house to make sure that household water pressure is adequate and flow is not restricted. Disconnect the inlet hose from the washer and run a few gallons of water through the hose to flush the water supply lines. If flow is too low, contact a plumber to have the water lines repaired.
- Water supply connected with leaklimiting hoses. Hoses designed to limit leaks can trip falsely and prevent the washer from filling. The use of leaklimiting hoses is not recommended.

2. [UE]

- If the balance is not successful, this error will be displayed. The automatic attempt to rebalance the load was not successful. The cycle has been paused to allow the load to be manually adjusted.
- The load is too small. Small loads may need additional items to be added to allow the washer to balance the loads.
- Heavy articles are mixed with lighter items. The load may have heavy items loaded with lighter items. Always try to wash articles of somewhat similar weight to allow the washer to evenly distribute the weight of the load for spinning.
- The load is out of balance. Manually redistribute the load if articles have become tangled, preventing the automatic distribution from working properly.
- The load contains pillows or cushions. Wash the covers only. Remove the stuffing from the pillows or cushions before washing the covers.

3. The tub does not rotate or [dE] [dE1] [dE2]

- The door is not secured. Close and secure the door. If the message keeps appearing, unplug the power cord and call for service.

4. Water in the washer drains slowly or not at all and [OE]

- Drain hose is kinked, pinched, or clogged Make sure the drain hose is free of clogs or kinks, and is not pinched behind or under the washer.
- Drain discharge is more than 96 inches (2.4 m) above bottom of washer. The end of the drain hose should be no more than 96 inches (2.4 m) above the bottom of the washer.

5. [tE]

- Control error. Unplug the washer and wait 60 seconds. Reconnect power and try again. If the error reappears, call for service

6. [FE]

- Water level is too high due to a faulty water valve. Close the water faucets, unplug the washer, and call for service.

7. [PE]

- The water level sensor is not working correctly. Close the water faucets, unplug the washer, and call for service

8. [LE]

- A motor error has occurred. Allow the washer to stand for 30 minutes and then restart the cycle. If the LE error code persists, call for service.

9. [Sud]

- If the washing machine detects too many suds, it displays this error code and adds a Suds Reducing cycle. This adds about 2 hours to the cycle time. If too many suds are detected during spinning, the washing machine stops to help prevent leaking. Do not add more than the manufacturer's recommended amount of detergent. To remove suds, turn the washer off and on, then run the Rinse+Spin cycle.

10. [PF]

- A power failure has occurred. Press the Power button to turn off the washing machine and press it again to turn it on.

11. [FF]

- Inlet hose, drain hose or drain pump frozen. See the Care in Cold Climates section for instructions.

12. [vS]

- Vibration sensor malfunction. Call for service

13. [CL]

- Control Lock is activated. This is not an error code. This code indicates that the Control Lock is activated. Press and hold Control Lock for 3 seconds.

14. [tCL]

- Tub Clean is activated or the washer drum needs cleaning. This is not an error code. This code indicates that the Tub Clean is activated or needed. Use the Tub Clean cycle to clean the washer drum.

Warning

This content is compiled from multiple sources and is provided for reference purposes only. It may not be complete or fully applicable to all situations. If you are unable to resolve your issue, please contact the product manufacturer or an authorized service provider for official support.