









Safety Information

- Do not attempt to operate this oven with the door open since open-door operation can result in harmful exposure to microwave energy. It is important not to defeat or tamper with the safety interlocks.
- Do not place any object between the oven front face and the door or allow soil or cleaner residue to accumulate on the sealing surface.
- Do not operate the oven if it is damaged. It is particularly important that the oven door closes properly and that:
 - 1. The door is not bent or damaged
 - 2. The hinges and latches are not broken or loosened
 - 3. The door seals and sealing surface are clean and operative.
- Only properly qualified service personnel should adjust or repair the oven. Do not attempt to adjust or repair the oven yourself.

	Do NOT attempt.
	Do NOT disassemble.
	Do NOT touch.
	Follow directions explicitly.
	Unplug the power plug from the wall socket.
	Make sure the machine is grounded to prevent electric shock.
	Call the service center for help.
	Note

These warning signs are here to prevent injury to you and others. Please follow them explicitly. After reading this section, keep it in a safe place for future reference.

IMPORTANT SAFETY INSTRUCTIONS

To reduce risk of burns, electric shock, fire, personal injury or exposure to excessive microwave energy:

1. Read all safety instructions before using the appliance.
2. Read and follow the specific "Precautions to avoid possible exposure to excessive microwave energy" on this page.
3. This appliance must be grounded. Connect only to properly grounded outlets. See Important "Grounding instructions" on page 4 of this manual.
4. Install or locate this appliance only in accordance with the provided installation instructions.
5. Some products such as whole eggs and sealed containers (for example, sealed glass jars), can explode if heated rapidly. Never heat them in a microwave oven.
6. Use this appliance only for its intended use as described in the manual. Do not put corrosive chemicals or vapors in or on this appliance. This type of oven is specifically designed to heat, cook, or dry food. It is not designed for industrial or laboratory use.
7. As with any appliance, close supervision is necessary when it is used by children.
8. Do not operate this appliance if it has a damaged power cord or plug, if it is not working properly, or if it has been damaged or dropped.
9. This appliance should be repaired or serviced only by qualified service personnel. Contact the nearest authorized service facility for examination, repair, or adjustment.
10. Do not cover or block any openings on the appliance.
11. Do not tamper with or make any adjustments or
12. Do not store this appliance outdoors. Do not use this product near water, for example, near a kitchen sink, in a wet basement, near a swimming pool, or similar locations.
13. Do not immerse the power cord or plug in water.
14. Keep the cord away from heated surfaces. (including the back of the oven).
15. Do not let the cord hang over the edge of a table or counter.
16. When cleaning surfaces of the door and oven that come together when the door closes, use only mild, nonabrasive soaps, or detergents applied with a sponge or soft cloth. Unplug the microwave before cleaning.
17. To reduce the risk of fire in the oven cavity:
 - Do not overcook food. Carefully attend appliance when paper, plastic, or other combustible materials are placed inside the oven to facilitate cooking.
 - Remove wire twist-ties from paper or plastic bags before placing the bags in the oven.

- If materials inside the oven ignite, keep the oven door closed, turn the oven off, and disconnect the power cord, or shut off the power at the fuse or circuit breaker panel. If the door is opened, the fire may spread. . Do not use the cavity for storage purposes.
- Do not leave paper products, cooking utensils, or food in the cavity when it is not in use.

18. Liquids, such as water, milk, coffee, or tea can be overheated beyond the boiling point without appearing to be boiling. Visible bubbling or boiling when the container is removed from the microwave oven is not always present.

THIS COULD RESULT IN VERY HOT LIQUIDS SUDDENLY BOILING OVER WHEN THE CONTAINER IS DISTURBED OR A SPOON OR OTHER UTENSIL IS INSERTED INTO THE LIQUID.

To reduce the risk of injury:

- a. Do not overheat liquid.
- b. Stir liquid both before and halfway through heating it.
- c. Do not use straight-sided containers with narrow necks.
- d. After heating, allow the container to stand in the microwave oven for a short time before removing the container.
- e. Use extreme care when inserting a spoon or other utensil into the container.

Caution:

- Clean Ventilating Hoods Frequently - Grease should not be allowed to accumulate on the hood or filter.
- When flaming foods under the hood, turn the fan on.
- Use care when cleaning the vent-hood filter. Corrosive cleaning agents, such as lye-based oven cleaner, may damage the filter.

Read more at Pdf File.

Setting Up Microwave Oven

SETTING UP MICROWAVE OVEN

1. Open the door by pulling the handle on the right side of the door.
2. Wipe the inside of the oven with a damp cloth.

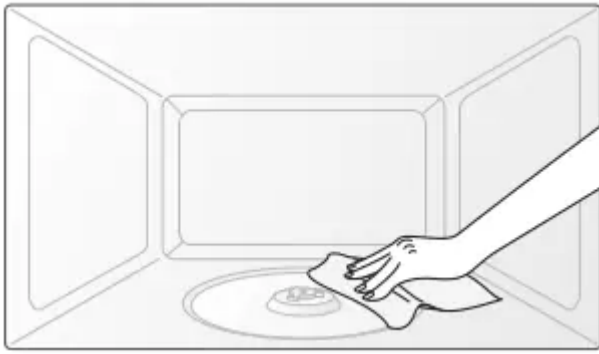

3. Install the pre-assembled ring into the indentation at the center of the microwave oven.

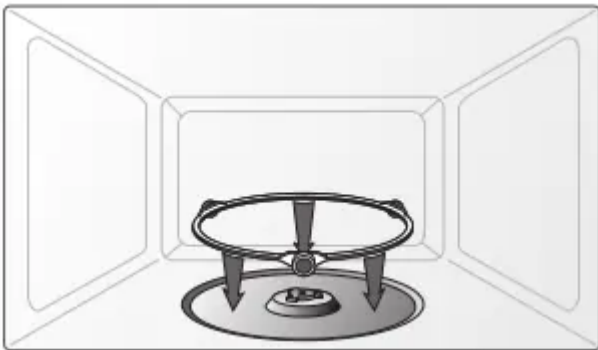

4. Place the glass tray securely in the center of the pre- assembled roller ring.

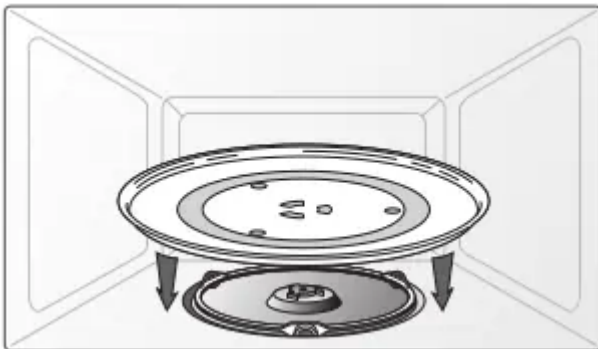

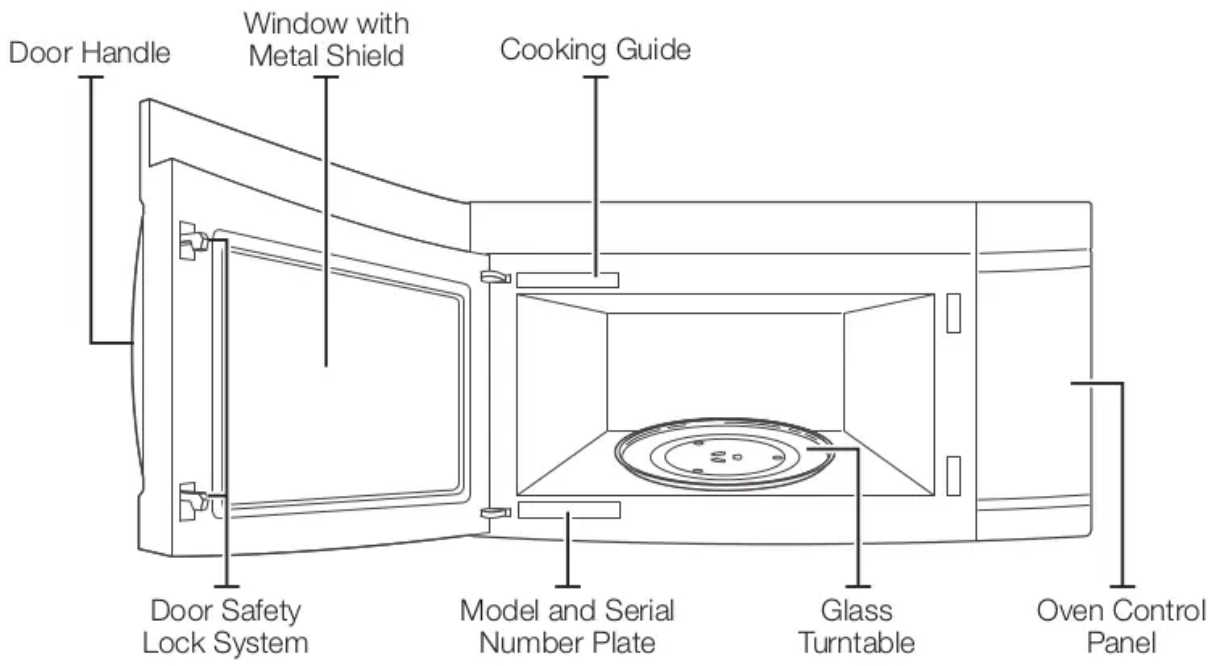

CHECKING THE CONTROL PANEL



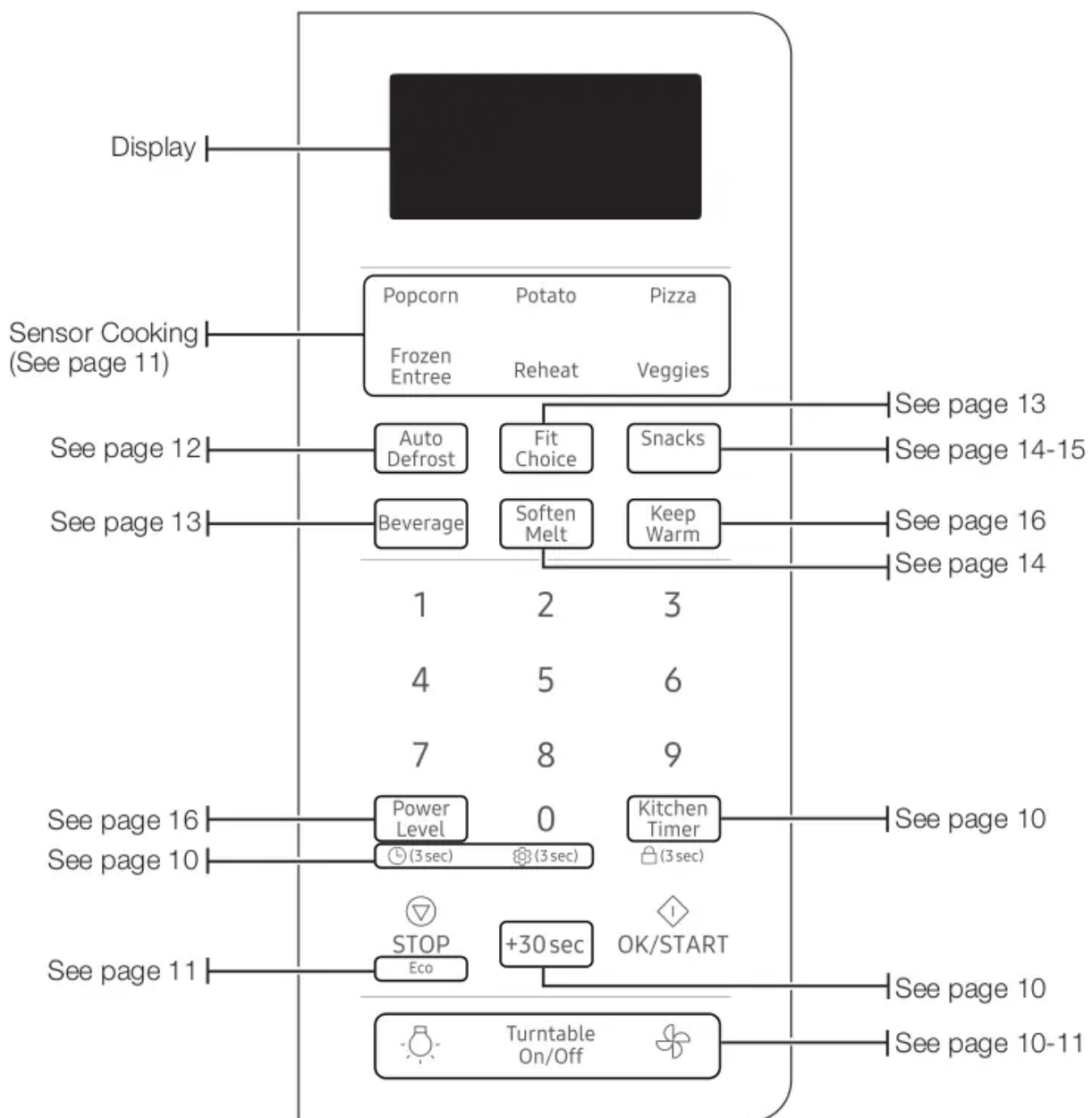

SETTING THE TIME

Your microwave oven is equipped with a built-in clock. Set the clock when first installing your microwave oven and after a power failure. The time is displayed whenever the microwave oven is not being used

1. Press the Power Level button for 3 seconds.
2. Use the number buttons to enter the current time. You need to press at least three numbers to set the clock. For example, if the current time is 5:00, press 5,0, 0. The display will show: 500.
3. Press the Power Level button
4. Use the Power Level button to select AM / PM.
5. Press the OK/START button

6. A colon appears indicating that the time is set.

CHILD LOCK

The Child Lock function allows you to lock the buttons so that the microwave oven cannot be operated accidentally. The oven can be locked at any time.

Activating/Deactivating

If you want to activate or deactivate the child lock function, press the Kitchen Timer button for 3 seconds.

The display will show *ON* when the oven is locked, and then re-displays the time.

OPTIONS

You can customize your new microwave oven to suit your preferences. To customize

1. Press the number 0 button for 3 seconds
2. Press the number button that corresponds to the function you want to customize.
3. Press the number that corresponds to the option you want to set.
4. Press the OK/START button to set the option

The functions, options, and corresponding number buttons are listed in the table below.

No.	Function	Options
1	Weight mode selected	1 Lbs. 2 Kg. (Gram)
2	Clock display control	1 12HR 2 24HR
3	Sound on/off control	1 Sound ON 2 Sound OFF
4	Remind end signal	1 ON 2 OFF
5	Daylight Saving time	1 ON 2 OFF
6	Demo mode	1 ON 2 OFF
7	Filter Reminder	1 ON 2 OFF

Filter Reminder

The filter should be cleaned or replaced once every four months. When it is time to clean or replace the filter, the microwave displays the "Filter" message to remind you to clean or replace the filter. To remove the message, touch the number 0 when the microwave is in standby mode, or access Options.

Using Microwave Oven

Cooking has never been easier than with your new Samsung microwave oven.

The following section describes everything you need to know about using your microwave oven.

KITCHEN TIMER BUTTON

Use the Kitchen Timer for timing up to 99 minutes. 99 seconds.

- 1. Press the Kitchen Timer button
- 2. Use the number buttons to set the length of time you want the timer to run.
- 3. Press the OK/START button.
- 4. The display counts down and beeps when the time has elapsed.
- 5. To cancel the timer setting: Press the STOP button once

ADD 30 SEC BUTTON

This simplified control saves you time, letting you quickly start cooking at 100 % power.

- 1. Press the Add 30 sec button for each 30 seconds you want food to cook. For example, press it twice to cook for one minute, and then press the OK/START button to start cooking
- 2. Add 30 sec to a cooking program already in progress by pressing the Add 30 sec button for every additional 30 seconds you want to add.

VENT BUTTON

The vent removes steam and other vapors from the cooking surface. You can manually select the vent setting

Press (times)	1	2	3	4	5
Speed	4	3	2	1	Off

The exhaust fan's speed will decrease when the oven's cooking function is activated.

LIGHT HI/LO/OFF BUTTON

The Light button allows you to select a light setting for your microwave.

Press (times)	1	2	3
Light	High	Low	Off

TURNTABLE ON/OFF BUTTON

For best cooking results, leave the turntable on. However, for large dishes it can be turned off.

Press the Turntable On/Off button to turn the turntable on or off.

The turntable may become too hot to touch. Use pot holders to touch the turntable during and after cooking



ECO MODE

Eco Mode reduces standby power usage.

To start ECO Mode, press the STOP button once. The display will go out and the microwave shifts to the Eco mode which minimizes power usage.

To cancel the Eco Mode, press the STOP button once again, or press any other button

SENSOR COOKING BUTTONS

The Sensor Cooking buttons let you cook favorite foods using preset power levels and times at the touch of a button

If the food is not thoroughly cooked or reheated when you use the auto cook feature, complete the cooking process by selecting a power level and cooking the food for an additional amount of time.

Do not use the Sensor Cooking buttons continuously. The oven must cool for 5 minutes between uses or the food will overcook.

Sensor Cooking Utensils & Covers

To obtain good cooking results using these functions, follow the directions for selecting the appropriate containers and covers in the Cookware section on page 16.

- Always use microwave-safe containers and cover with a lid or plastic wrap. When using plastic wrap, turn back one corner to allow steam to escape.
- Fill containers at least half full.
- Foods that require stirring or rotating should be stirred or turned at the end of the Sensor Cook cycle, when the time has started to count down on the display.
- Do not use the Auto Sensor cooking feature continuously. Wait 5 minutes before selecting another sensor cooking operation.
- To avoid poor results, do not use the Auto Sensor when the room ambient temperature is too high or too low.

Sensor cooking table

REHEAT BUTTON

Heating leftovers and precooked foods is easy with your new microwave. By actually sensing the humidity that escapes as the food is heated, the oven's heating time is automatically adjusted depending on the type and amount of precooked food.

All food must already be precooked, Plates of food and casseroles should be stored at refrigerator temperature Press the Reheat button and OK/START button to begin reheating your precooked food.

Reheating table

Follow the instructions below when reheating different types of food.

Food	Amount	Procedure
Dinner plate (rh-2)	1 serving (1 plate)	Use only precooked, refrigerated foods. Cover the plate with vented plastic wrap or waxed paper tucked under the plate. If the food is not as hot as you would like after using the Sensor Reheat function, continue heating using additional time and power. Contents: 3-4 oz. meat, poultry, or fish (up to to 6 oz. with bone) ½ cup starch (potatoes, pasta, rice, etc.) ½ cup vegetables (about 3 - 4 oz.)
Casserole (rh-1)	1 to 4 servings	Cover the plate with a lid or vented plastic wrap. If the food is not as hot as you would like after using the "Sensor Reheat" function, continue heating using additional time and power. Stir the food once before serving. Contents: Casserole, refrigerated foods.
Pasta (rh-3)		Pasta: canned spaghetti and ravioli

AUTO DEFROST BUTTON

To thaw frozen foods, enter the weight of the food, and the microwave automatically sets the defrosting time, power level, and standing time. Press the OK/START button to start defrosting.

- 1. Press the Auto Defrost button.
- 2. Press the number buttons to directly enter the weight of the food.
- 3. Press the OK/START button.
- 4. The oven will beep twice during the defrosting process. Open the oven door, and turn the food over.

Auto defrosting table

Follow the instructions below when defrosting different types of food.

Food	Amount	Procedure
Roast Beef, Pork	2.5-6.0 lbs.	Start with the food placed fat side down. After each stage, turn the food over and shield any warm portions with narrow strips of aluminum foil. Let stand, covered for 10-20 minutes.
Steaks, Chops, Fish	0.5-3.0 lbs.	After each stage, rearrange the food. If there are any warm or thawed portions of food, shield them with narrow, flat pieces of aluminum foil. Remove any pieces of food that are nearly defrosted. Let stand, covered for 5-10 minutes.
Ground Meat	0.5-3.0 lbs.	After each stage, remove any pieces of food that are nearly defrosted. Let stand, covered with foil for 5-10 minutes.
Whole Chicken	2.5-6.0 lbs.	Remove giblets before freezing poultry. Start defrosting with the breast side down. After the first stage, turn the chicken over and shield any warm portions with narrow strips of aluminum foil. After the second stage, again shield any warm portions with narrow strips of aluminum foil. Let stand, covered for 30-60 minutes in the refrigerator.
Chicken Pieces	0.5-3.0 lbs.	After each stage, rearrange or remove any pieces of food that are nearly defrosted. Let stand for 10-20 minutes.

Check the food when you hear the oven signal. After the final stage, small sections may still be icy. Let the food stand to continue the thawing process. The food is not defrosted until all ice crystals have thawed. Shielding the edges of roasts and pieces of steak using small pieces of foil prevents the edges from being cooked before the center of the food has defrosted. Use narrow, flat, smooth strips of aluminum foil to cover edges and thinner sections of the food.

1 POUND DEFROST FUNCTION

To thaw 1 pound of frozen food, use the 1 Pound Defrost Function. The microwave will automatically set the defrosting time, power level and standing time.

- 1. Press the Auto Defrost button twice. The display shows: 1.0 LB.
- 2. Press the OK/START button to start defrosting.
- 3. The oven will beep and the display will read 7 door, and turn the food over.
- 4. If you do not turn the food over when START button, twice during the defrosting process. Open the oven is displayed, the oven will pause until you press the OK.

FIT CHOICE BUTTON

- 1. Press the Fit Choice button. Press the button repeatedly to cycle through the available items. (Refer to the Fit Choice table below for a list of the items.)
- 2. Press the 1, 2, 3, or 4 button to select the amount
- 3. Press the OK/START button to begin cooking

BEVERAGE BUTTON

- 1. Press the Beverage button.
- 2. Press the 1, 2, or 8 button to select the Amount.
- 3. Press the OK/START button.

Food	No. / Amount	Procedure
Beverage	1 0.5 cup	Use a measuring cup or mug and do not cover. Place the beverage in the oven. After heating, stir well. Let the oven cool for at least 5 minutes before using it again.
	2 1 cup	
	3 2 cups	

SOFTEN/MELT BUTTON

- 1. Press the Soften/Melt button. Press the button repeatedly to cycle through the available items. (Refer to the Soften/Melt table below for a list of the items.)
- 2. Press the number 1 or 2 button to select the amount. You can cook only 1 serving for the Melt Chocolate, Soften Butter, and Soften Cream Cheese options. (Refer to the Soften/Melt table for the serving size.)
- 3. Press the OK/START button to begin cooking.

Soften / Melt table





Menu / Item		No. / Amount		Remarks
St-1	Melt butter	1	1 stick	Remove the wrapping and cut the butter in half vertically. Place the butter in a dish and cover with wax paper. Stir well after finishing and let stand for 1-2 minutes.
		2	2 sticks	
St-2	Melt chocolate	1	1 cup chips or 1 square	Place the chocolate chips or squares in a microwave-safe container. When the oven beeps, stir the chocolate and restart the oven. Stir and let stand for 1 minute.
St-3	Soften butter	1	1 stick (¼ lbs.)	Remove wrapping and cut butter in half vertically. Place butter in dish, cover with wax paper.
St-4	Soften cream cheese	1	1 Package (8-oz)	Unwrap the cream cheese and place on a microwave-safe container. Cut in half vertically. Let stand for 2 minutes.

SNACKS BUTTON

1. Press the Snacks button. Press the button repeatedly to cycle through the available items. (Refer to the Snack bar table below for a list of the items.)
2. Press the number 1 or 2 button to select the serving size. You can cook only 1 serving for Nachos. (Refer to the Snack bar table for the serving size.)
3. Press the OK/START button to begin cooking.

Snack bar table

Menu / Item		No. / Amount		Remarks
Sn-1	Frozen Chicken Nugget	1	1 serving (3 oz)	Place a paper towel on a plate and arrange the nuggets in a spoke-like fashion on the paper towel. Do not cover. Let stand for 1 minute after heating.  Refer to the package directions for the serving size and the amount of food.
		2	2 servings (6 oz)	
Sn-2	Frozen French Fries	1	1 serving (3 oz)	Place two paper towels on a microwave-safe plate and arrange the French fries on the towels without letting them overlap. Blot the fries with additional paper towels after removing from the oven. Let stand for 1 minute.  Refer to the directions on the packaging for the serving size and the amount of food.
		2	2 servings (6 oz)	
Sn-3	Frozen Sandwiches (in crisping sleeve) 9-oz package size	1	1 sandwich	Place the frozen sandwich in a susceptor "crisping sleeve" (which is in the package) and place on a microwave-safe plate. Remove from the "crisping sleeve". Let stand for 2 minutes after heating.
		2	2 sandwiches	
Sn-4	Hot dogs	1	2 hot dogs	Pierce the hot dogs and place them on a plate. When the oven beeps, add the buns and restart the oven. Let stand for 1 minute after heating.  For the best texture, the buns should be added to the hot dogs when the oven beeps.
		2	4 hot dogs	

MICROWAVE COOKING TIMES & POWER LEVELS

Your oven allows you to set two different cooking stages, each with its own time length and power level. The power level lets you control the heating intensity from Warm (1) to High (10).

One-stage cooking

For simple, one-stage cooking with the power level set to High (10), you only need to set the cooking time, and then press OK/START. The power level is automatically set to High. If you want to set the power level to any other level, use the Power Level button.

1. Use the number buttons to set a cooking time. You can enter a time from one second to 99 minutes and 99 seconds. To select a time greater than one minute, enter the seconds too. (For example, to set a cooking time of 20 minutes, enter 2, 0, 0, 0.)
2. If you want to set the power level to a level other than High, press the Power Level button, and then use the number buttons to enter the power level
3. Press the OK/START button to begin cooking. If you want to change the power level, press the STOP button before you press the OK/START button, and then follow the instructions from Step 1 again.

Some recipes require different cooking stages at different temperatures. Your microwave allows you to set multiple cooking stages.

Multi-stage cooking

- 1. Follow steps 1 and 2 from the "One-stage cooking" section.
- 2. Use the number buttons to set a second cooking time.
- 3. Press the Power Level button, and then use the number buttons to set the power level for the second cooking stage.
- 4. Press the OK/START button to begin cooking.

When selecting more than one cooking stage, you must press the Power Level button before you can enter the second cooking stage time and power level (Z Press the Power Level button twice to set the power level to High for a cooking stage.

Power Levels

The 10 power levels allow you to choose the optimal power level for your cooking needs.

1	Warm	6	Simmer
2	Low	7	Medium high
3	Defrost	8	Reheat
4	Medium low	9	Sauté
5	Medium	10	High

KEEP WARM

You can keep cooked food warm in your microwave oven for up to 99 minutes 99 seconds.

- 1. Press the Keep Warm button.
- 2. Enter the warming time.
- 3. Press the OK/START button.

Keep Warm operates for up to 99 minutes 99 seconds.

Food that is cooked covered should also be covered during Keep Warm.

Pastry items (pies, turnovers, etc.) should be uncovered during Keep Warm. Complete meals kept warm on a dinner plate can be covered during Keep Warm.

Below are the amounts of food we recommend you apply the Warm and Hold function to by Food Type.

Food type	Recommended Quantity
Liquid	1-2 cups
Dry	5-10 oz.

Cookware Guide

For food to cook in the microwave oven, the microwaves must be able to penetrate the food without being reflected or absorbed by the dish.

It is important to choose the correct cookware. Therefore, look for cookware that is marked microwave-safe.

The following table lists various types of cookware and indicates if and how they should be used in a microwave oven.



MICROWAVE-SAFE UTENSILS

If you are not sure whether an item is microwave-safe, you can perform the following simple test:

1. Place 1 cup of water (in a glass-measuring cup) inside your oven next to the item to be tested.
2. Press the Add 30 sec button twice to heat them both for one minute at high power.

After one minute, the water should be warm and the item you are testing should be cool. If the dish is warm, then it is absorbing microwave energy and is not microwave-safe.

Cookware		Comments
Aluminum foil	⚠	Can be used in small quantities to protect areas against overcooking. Arcing can occur if the foil is too close to the oven wall or you use too much foil.
Browning plate	✓	Do not preheat for more than eight minutes.
Ceramic, porcelain, and stoneware	✓	Porcelain, pottery, glazed earthenware, and bone china are usually suitable, unless decorated with a metal trim.
Disposable polyester cardboard	✓	Some frozen foods are packaged in these materials.
Fast-food packaging		
Polystyrene cups/containers	✓	Can be used to warm food. Overheating may cause the polystyrene to melt.
Paper bags or newspaper	—	May catch fire.
Recycled paper or metal trims	—	May cause arcing.

Microwave energy actually penetrates food. attracted and absorbed by the water, fat, and sugar in the food. The microwaves cause the molecules in the food to move rapidly. The rapid movement of these molecules creates friction and the resulting heat cooks the food.

GENERAL MICROWAVE TIPS

Dense foods, such as potatoes, take longer to heat than lighter foods. Foods with a delicate texture should be heated at a low power level to prevent them from becoming tough.

Foods with a non-porous skin such as potatoes or hot dogs, should be pierced to prevent bursting.

Putting heating oil or fat in the microwave is not recommended. Fat and oil can suddenly boil over and cause severe burns.

Some ingredients heat faster than others. For example. the jelly in a jelly doughnut will be hotter than the dough.

Keep this in mind to avoid burns.

The altitude and the type of cookware you are using can affect the cooking time. When trying a new recipe. use the minimum cooking time and check the food occasionally to prevent overcooking.

Home canning in the microwave oven is not recommended because not all harmful bacteria may be destroyed by the microwave heating process.

Although microwaves do not heat the cookware, the heat from the food is often transferred to the cookware. Always use pot holders when removing food from the microwave and instruct children to do the same.

Making candy in the microwave is not recommended as candy can be heated to very high temperatures. Keep this in mind to avoid injury.

Cooking techniques

If the oven is set to cook for more than 20 minutes, it will automatically adjust to 70 percent power after 20 minutes to avoid overcooking.

Stirring

Open the microwave door and stir foods such as casseroles and vegetables occasionally while cooking to distribute heat evenly. Food at the outside of the dish absorbs more energy and heats more quickly, so stir from the outside towards the center. The oven will turn off when you open the door to stir your food.

Arrangement

Arrange unevenly shaped foods, such as chicken pieces or chops, with the thicker, meatier parts toward the outside of the turntable where they can receive more microwave energy. To prevent overcooking, place thin or delicate parts towards the center of the turntable.

Shielding

Shield food with narrow strips of aluminum foil to prevent overcooking. Areas that need shielding include poultry wing-tips, the ends of poultry legs, and corners of square baking dishes. Use only small amounts of aluminum foil. Larger amounts can damage your oven.

Standing

Foods cooked in the microwave build up internal heat and continue to cook for a few minutes after the oven stops. Let foods stand to complete the cooking process. especially foods such as roasts and whole vegetables.

Roasts need this time to complete cooking in the center without overcooking the outer areas. All liquids, such as soup or hot chocolate should be shaken or stirred when cooking is complete. Let liquids stand a moment before serving. When heating baby food, stir well and test the temperature before serving.

Adding moisture

Microwave energy is attracted to water molecules. Food that is uneven in moisture content should be covered or allowed to stand so that the heat disperses evenly. Add a small amount of water to dry food to help it cook.

Venting

After covering a dish with plastic wrap, vent the plastic wrap by turning back one corner to let excess steam escape.

COOKING MEAT

Place the meat fat side down on a microwave-safe roasting rack in a microwave-safe dish. Use narrow strips of aluminum foil to shield any bone tips or thin pieces of meat. Check the temperature in several places before letting the meat stand the recommended time.

The following temperatures are the removal temperatures.

The temperature of the food will rise during standing time.

The following temperatures are the removal temperatures. The temperature of the food will rise during standing time. Expect a 10 °F rise in temperature during the standing time.

Food		Remove from oven	After standing (10 MIN.)
Beef	Rare	135 °F	145 °F
	Medium	150 °F	160 °F
	Well Done	160 °F	170 °F
Pork	Medium	150 °F	160 °F
	Well Done	160 °F	170 °F
Poultry	Dark meat	170 °F	180 °F
	Light meat	160 °F	170 °F

COOKING POULTRY

Place the poultry on a microwave-safe roasting rack in a microwave-safe dish and cover with wax paper to prevent spattering. Use aluminum foil to shield the bone tips, thin pieces of meat, or areas that may start to overcook.

Check the temperature in several places before letting the poultry stand the recommended time.



Food	Cooking time/ power level	Instructions
Whole chicken Up to 4 lbs.	Cooking Time: 7-11 min. / lb. 180 °F dark meat 170 °F light meat	Place the chicken breast-side down on the roasting rack. Cover with wax paper. Turn over half way through cooking process. Cook until the juices run clear and the meat near the bone is no longer pink. Let stand for 5-10 minutes.
	Power Level: Medium High (7).	
Chicken pieces Up to 2 lbs.	Cooking Time: 7-10 min. / lb. 180 °F dark meat 170 °F light meat	Place the chicken bone-side down on the dish, with the thickest portions towards the outside of the dish. Cover with wax paper. Turn over halfway through the cooking process. Cook until the juices run clear and the meat near the bone is no longer pink. Let stand for 5-10 minutes.
	Power Level: Medium High (7).	

COOKING SEAFOOD

Place the fish on a microwave-safe roasting rack in a microwave-safe dish. Use a tight cover to steam the fish.

A lighter cover of wax paper or paper towel will decrease steaming. Cook the fish until it flakes easily with a fork. Do not over cook fish. Check it after the minimum cooking time.

COOKING EGGS

You can use your microwave oven to cook eggs. Cook them until they are just set as they become tough if they are overcooked.

Never cook eggs in their shells and never warm warm UP hard-boiled eggs in their shells. Eggs cooked or warmed up in their shells can explode. Always pierce whole eggs to keep them from bursting.

COOKING VEGETABLES

Vegetables should be washed prior to cooking. Usually, no extra water is needed. When cooking dense vegetables such as potatoes, carrots, and green beans, add about 1/4 cup water.

Small vegetables (sliced carrots, peas, lima beans, etc.) will cook faster than larger ones.

Whole vegetables, such as potatoes, acorn squash, or corn on the cob, should be arranged in a circle on the turntable before cooking. They will cook more evenly if turned over halfway through the cooking process.

Always place vegetables such as asparagus and broccoli with the stems pointing towards the edge of the dish and the tips toward the center.

When cooking cut vegetables, always cover the dish with a lid or vented microwavable plastic wrap.

Whole, unpeeled vegetables such as potatoes, squash, eggplant, etc., should have their skins pierced in several spots before cooking to prevent them from bursting.

For a more even cooking result, stir or rearrange whole vegetables halfway through the cook time.

Generally, the denser the food, the longer the standing time. (The standing time refers to the time necessary for dense, large foods and vegetables to finish cooking after they come out of the oven.) A baked potato can stand on the counter for five minutes before cooking is completed, while a dish of peas can be served immediately.

Cleaning and Maintaining Microwave Oven

Keeping your microwave oven clean improves its performance, wards off unnecessary repairs, and lengthens its life.

CLEANING THE EXTERIOR

It's best to clean spills on the outside of your microwave oven as they occur. Use a soft cloth and warm, soapy water. Rinse and dry.

Do not get water into the vents. Never use abrasive

Gonon Products or chemical solvents such as ammonia or alcohol as they can damage the appearance of your microwave.

Cleaning under your microwave oven

Regularly clean grease and dust from the bottom of your microwave using a solution of warm water and detergent.

Cleaning the control panel

Wipe with a damp cloth and dry thoroughly. Do not use cleaning sprays, large amounts of soap and water, abrasives, or sharp objects on the panel as it is easily damaged.

Cleaning the door and door seals

Always ensure that the door seals are clean and that the door closes properly. Take particular care when cleaning the door seals to ensure that no particles accumulate and prevent the door from closing correctly. Wash the glass door with very mild soap and water. Be sure to use a soft cloth to avoid scratching.

If a thin film of water accumulates on the inside or outside of the oven door, wipe it off with a soft cloth. A thin water film can accumulate when you operate the oven when humidity is high and in no way indicates microwave leakage.

CLEANING THE INTERIOR

Ensure that the microwave oven has cooled down before cleaning it to avoid injury.

Remove the glass tray from the oven when cleaning the oven or tray. To prevent the tray from breaking, handle it with care and do not put it in water immediately after cooking. Wash the tray carefully in warm sudsy water or in the dishwasher.

Clean the interior surfaces (oven cavity) of your microwave oven periodically to remove any splashes or stains. To remove hardened food articles and remove smells, place 2 cups of water (add lemon juice for extra freshness) into a four-cup measuring glass. Run the microwave at High power for 5 minutes or until the water boils. Let the water stand in the oven for one or two minutes.

CLEANING THE TURNTABLE AND ROLLER RINGS

Clean the roller rings periodically and wash the turntable as required. You can wash the turntable safely in your dishwasher.

STORING AND REPAIRING YOUR MICROWAVE OVEN

If you need to store your microwave oven for a short or extended period of time, choose a dust-free, dry location. Dust and dampness may adversely affect the ability of the microwave parts.

- Do not repair, replace, or service any part of your microwave oven yourself. Allow only a qualified service technician to perform repairs. If the oven is faulty and needs servicing, or you are in doubt about its condition, unplug the oven from the power outlet and contact your nearest Samsung service center.
- Do not use the oven if it is damaged, in particular, if the door or door seals are damaged.
- Door damage includes a broken hinge, a worn out seal, or a distorted/bent casing.
- Do not remove the oven from its casing.
- This microwave oven is for home use only and is not intended for commercial use.

REPLACING THE COOKTOP/NIGHT LIGHT

When replacing the cooktop/night light, make sure that you are wearing gloves to avoid injury from the heat of the bulb.

- 1. Unplug the oven or turn off the power at the main power supply.
- 2. Remove the screw from the light cover and lower the cover.
- 3. Replace the bulb with a 20 watt halogen lamp.
- 4. Replace the light cover and mounting screw.
- 5 Turn the power back on at the main power supply or plug the microwave in.

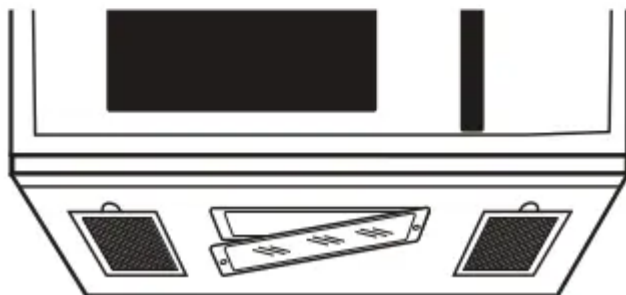
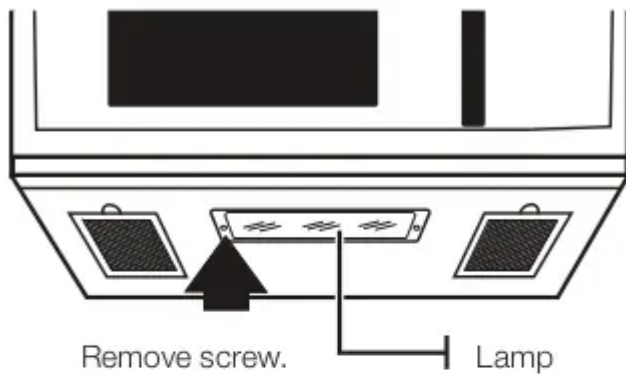

REPLACING THE OVEN LIGHT

When replacing the oven light, make sure that you are wearing gloves to avoid injury from the heat of the bulb.

1. Unplug the oven or turn off the power at the main power supply.
2. Open the door.
3. Remove the vent cover mounting screws (2 middle screws).
4. Slide the vent grille to the left, then pull it straight out.
5. Remove the charcoal filter, if present.
6. Remove the cover by pushing the hook and pulling up the lever.
7. Remove the bulb by turning it gently.
8. Replace the bulb with a 40 watt appliance bulb.

9. Replace the bulb holder.
10. Replace the vent grille and the 2 screws.
11. Turn the power back or plug the microwave in.

CLEANING THE GREASE FILTER

Your microwave oven has reusable grease filter. The grease filters should be removed and cleaned at least once every four months or as required.

Your microwave oven has a filter reminder function. See page 10 for details.

A To avoid risk of personal injury or property damage. vanwna GO NOT operate the oven hood without the filters in place.

1. To remove the filter, slide them to the rear using the tabs, then pull down and out.

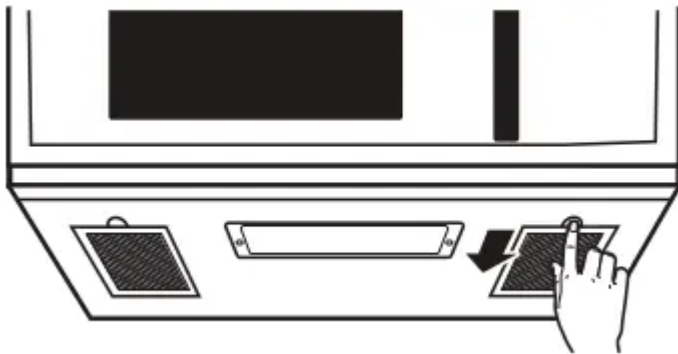

2. Soak the grease filter in hot water and a mild detergent. Rinse well and shake to dry. Brushing the filter lightly can remove embedded dirt. Do not use ammonia or put the grease filter in the microwave oven cavity to dry. The aluminum will darken.

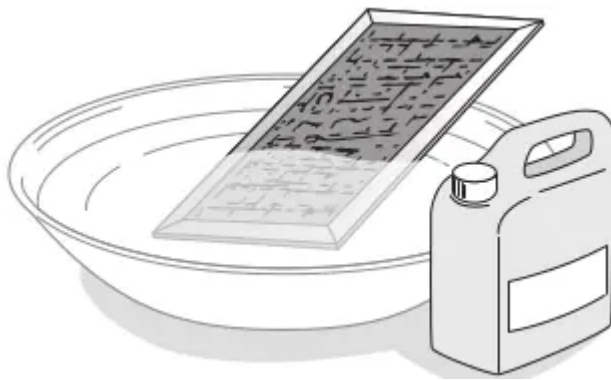

3. To re-install the filter, slide it into the frame slots on the back of each opening, and then press up and to the front to lock it.

REPLACING THE CHARCOAL FILTER

1. Unplug the oven or turn off the power at the main power supply.
2. Open the door.

3. Remove the vent grille mounting screws (2 middle screws).
4. Slide the vent grille to the left, then pull it straight out.
5. Push the hook, and then remove the old filter.

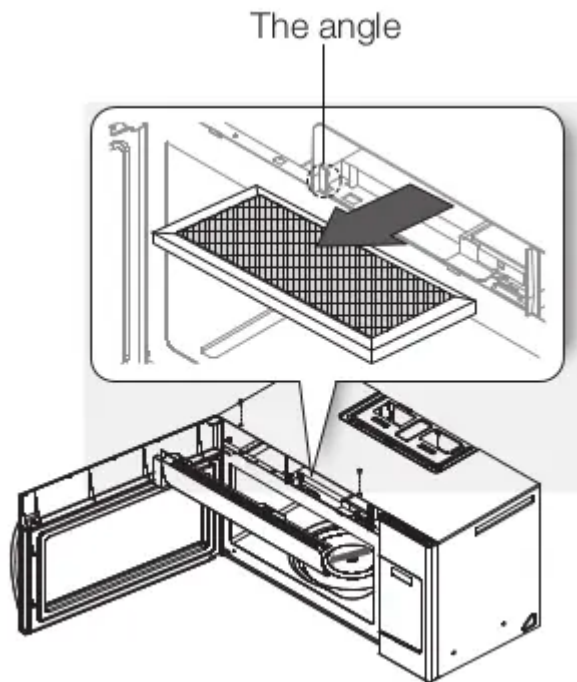

6. Slide a new charcoal filter into place. The filter should rest at the angle shown.
7. Replace the vent grille and 2 screws, and then close the door. Turn the power back on, and then set the clock.

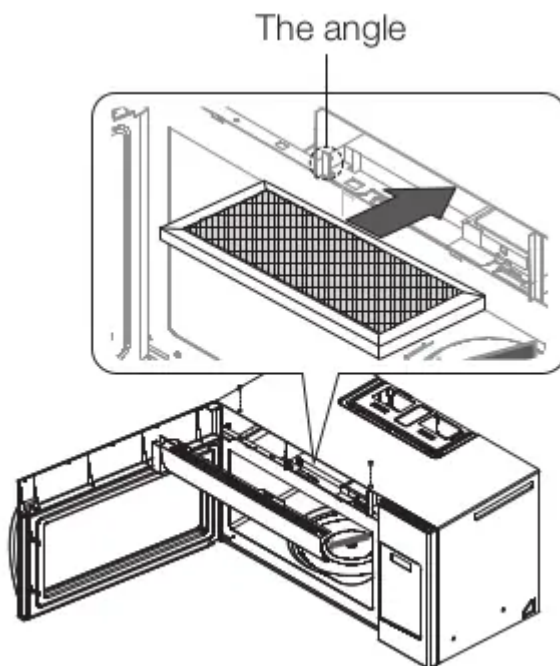

Troubleshooting

Check these solutions if you have a problem with your microwave:

Problem: The display and/or the oven is not working.

- **Solutions:** Make sure the plug is properly connected to a grounded outlet. If the wall outlet is controlled by a wall switch, make sure the wall switch is turned on. Remove the plug from the outlet, wait ten seconds, and plug it in again. Reset the circuit breaker or replace any blown fuses. Plug a different appliance into the outlet. If the other appliance doesn't work, call a qualified electrician to repair the wall outlet. Plug the oven into a different outlet.

The display is working, but the power won't come on.

- Make sure the door is closed securely. Check if any packaging material or anything else is stuck in the door seal. Check if the door is damaged. Touch Cancel twice and enter all the cooking instructions again.

Is the power going off before the set time has elapsed?

- If there was a power outage, the time indicator will display: 88:88.
- If no power outage occurred, remove the plug from the outlet, wait ten seconds, and plug it in again.
- Reset the clock and any cooking instructions.
- Reset the circuit breaker or replace any blown fuses.

Cooks food too slowly.

- Make sure the oven has its own 15 to 20 amp circuit line. Operating another appliance on the same circuit can cause a voltage drop. If necessary, move the oven to its own circuit.

Has sparks or arcing.

- Remove any metallic utensils, cookware, or metal ties. If using foil, use only narrow strips and allow at least one inch between the foil and the interior oven walls.

The turntable makes noise or becomes stuck.

- Clean the turntable, roller ring, and oven floor.
- Make sure the turntable and roller ring are positioned correctly.

Causes TV or radio interference.

- This is similar to interference caused by other small appliances, such as hair dryers. Move your microwave (or appliance) away from the affected appliances, such as your TV or radio.

Vent Motor suction force is too weak.

- Set the vent mode to high. The Vent Fan will only operate in low speed mode while the microwave is working.

Operating noise is too loud.

- The microwave makes noise during operation. This is normal. If you hear an abnormal sound continuously, please contact the Samsung Call Center (1-800-726- 7864).

Cook top lamp, is too dim.

- Set the lamp brightness level to high.

Difficult to replace Charcoal Filter.

- Please refer to the instructions for replacing the charcoal filter in the user's manual.

Turntable rotates improperly

- Make sure you have not put too much food on the turntable.
- If the food is too large or too heavy, the turntable may operate improperly.

The unit is not heating

- Make sure the door closes completely. If the door is not completely shut, the microwave may run but will not heat.
- Make sure that the Kitchen Timer option was not accidentally used instead of a normal cooking cycle.
- Check the clearance to the left, right, above, and behind the microwave. If the microwave does not have enough clearance, it will be unable to vent properly. It will either not heat or have weak heat.
- If the unit is in Demo mode, turn it off.
- If the microwave still doesn't heat, please contact the Samsung Call Center (1-800-726-7864)

Warning

This content is compiled from multiple sources and is provided for reference purposes only. It may not be complete or fully applicable to all situations. If you are unable to resolve your issue, please contact the product manufacturer or an authorized service provider for official support.