

GETTING TO KNOW THE APPLIANCE

Washing machine

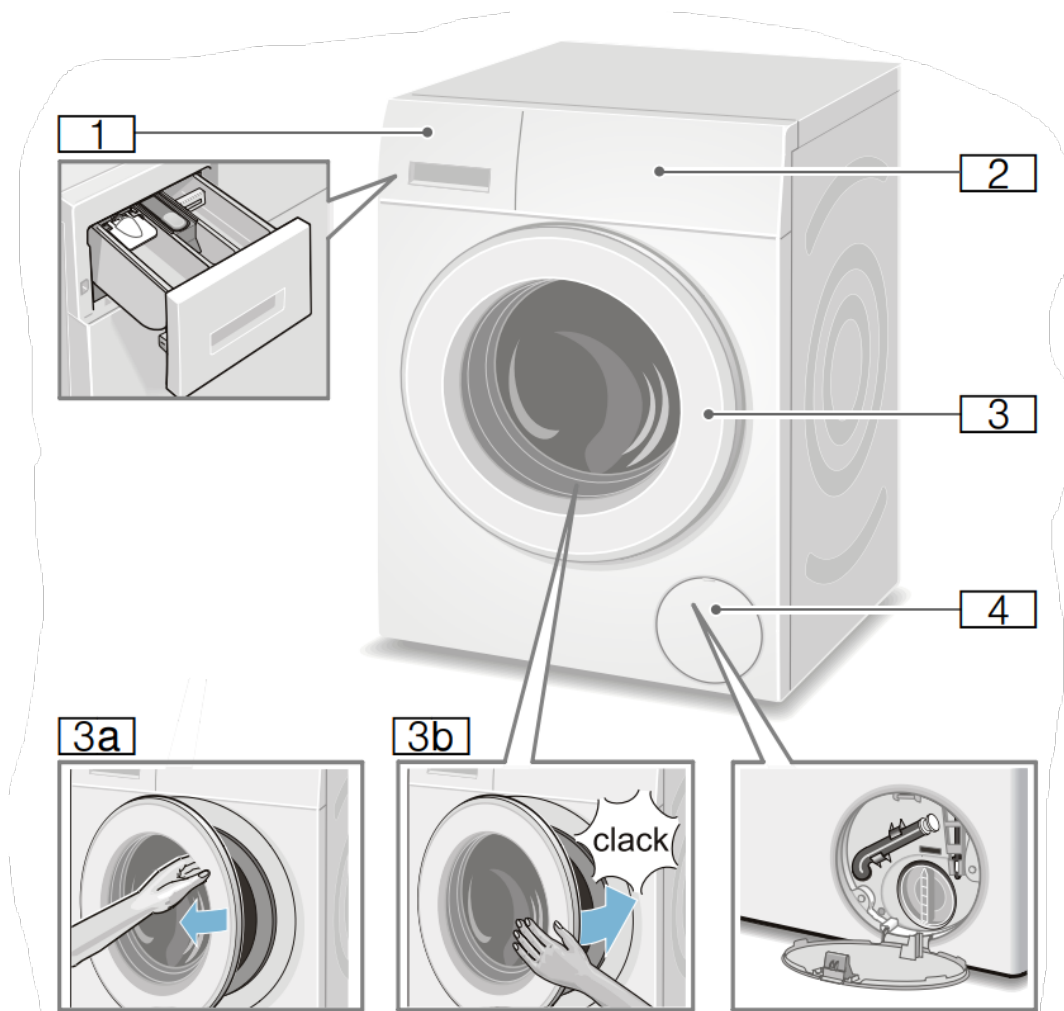

1. Detergent drawer ~ Page 21

2. Operating/display panel

3. Door with door handle

3a. Open the door

3b. Close the door

4. Service flap

Control panel

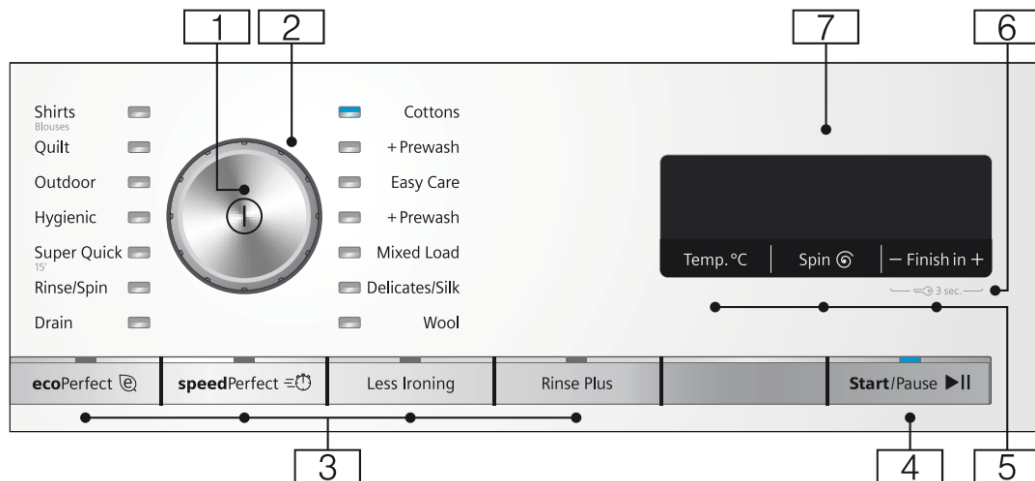



Note: All the buttons are sensitive except for the main switch) and only need to be pressed lightly.

1. Main switch for switching the washing machine on and off:

Press the  button.

2. Programme selector for selecting a programme.

3. Additional programme settings:

- ecoPerfect 
- speedPerfect 
- Rinse Plus,
- Less Ironing

4.  button for:

- Starting a programme
- Interrupting a programme, e.g. to add items of laundry
- Cancelling a programme

5. Changing the default programme settings:

- Temperature (Temp. °C),
- Spin speed (Spin ) ,
- Finish in time

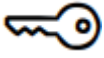
6. Child lock ( 3 sec.) to prevent the set functions from being changed accidentally:

To do so, press Finish in + and - simultaneously for approx. 3 seconds.

7. **Display panel** for settings and information.

Display panel

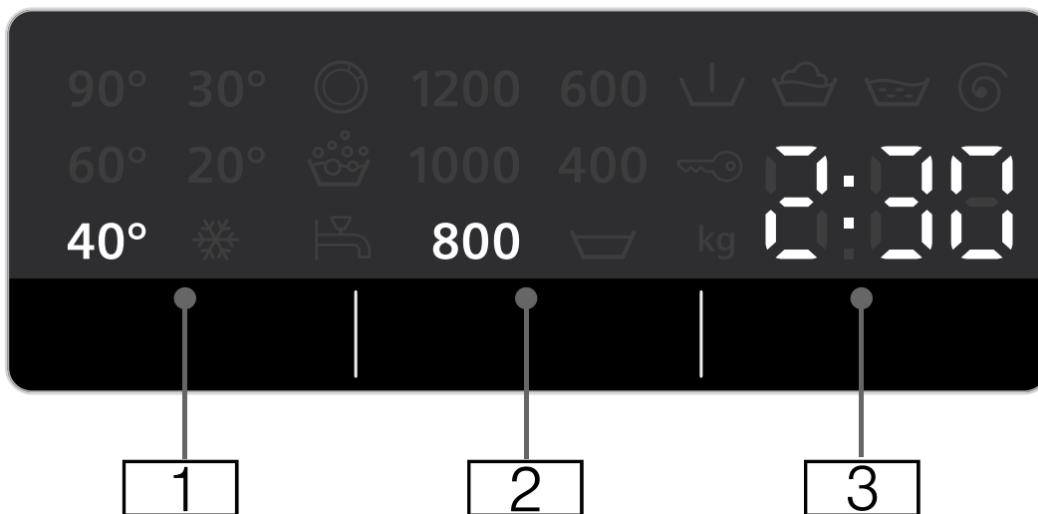

Default programme settings:

1. Temperature in °C cold)

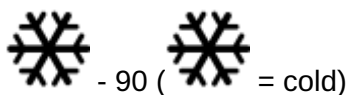

2. Spin speed in rpm,  - 1600*;

*Max. spin speed, depending on the selected programme and model,





 = Rinse Stop

3.



- **Finish in time** e.g. 2:30; Programme duration depends on the programme selection in h:min (hours:minutes),
- **Preselection of end time** Programme ends after ... h (h = hours)
- **Load recommendation** e.g. kg 8*; *depending on the selected programme

Further information



Programme progress:

	Prewash
	Washing
	Rinse
	Spin
- 0 -	Programme end
	Programme end during Rinse Stop
- P -	Pause, e.g. to reload laundry

Washing machine door:

 lights up	The washing machine door can be opened.
 flashes	When the programme has started: The washing machine door is not closed properly.

Tap:

 lights up	Tap not turned on, no water pressure
 flashes	Water pressure too low (may increase the programme duration)

Childproof lock: → *Page 23*

 Childproof lock activated
lights up

 Childproof lock activated,
flashes programme selector adjusted

Foam detection:

 → *Page 23*
lights up

Fault display:

E: - - → *Page 30*

Signal setting:

0 - 4 → *Page 25*

Switching off the appliance automatically:

On OFF → *Page 8*, → *Page 25*

Washing machine User Manual

LAUNDRY

Prepare the laundry

Caution! Damage to the appliance/fabrics

Foreign objects (e.g. coins, paper-clips, needles, nails) may damage the laundry or components in the washing machine.

Therefore, note the following tips when preparing your laundry:

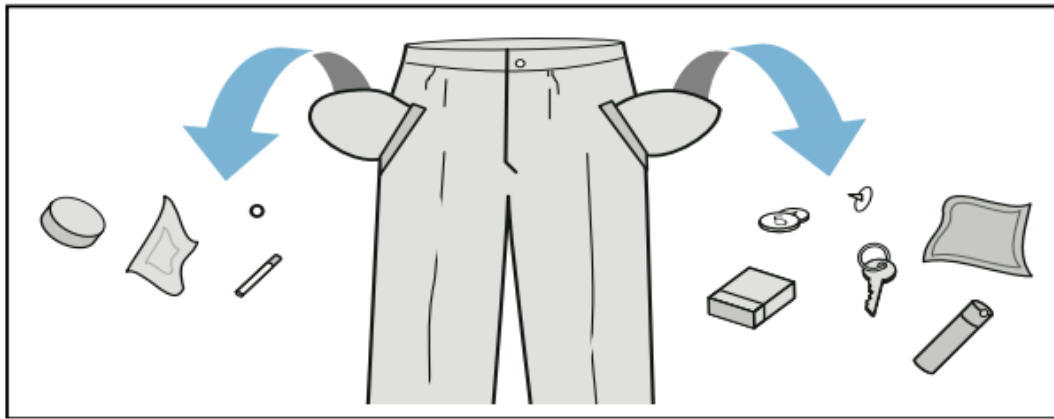

- Empty pockets.
- Look out for metal items (paperclips, etc.) and remove them.
- Wash delicates in a laundry bag (tights, underwired bras, etc.).
- Close any zips, button up any cover buttons.
- Brush sand out of pockets and collars.
- Remove curtain fittings or place curtains in a laundry bag.

Sorting laundry

Sort your laundry according to the care instructions and manufacturer's information on the care labels, depending on:

- Type of fabric/fibre
- Colour

Note: Laundry can discolour or not be cleaned correctly. Wash white and coloured laundry separately. Wash new bright fabrics separately the first time you wash them.

- Soiling: Wash laundry with the same level of soiling together. Some examples of soiling levels can be found on

- Light: Do not prewash, select the SpeedPerfect  setting if necessary
- Normal
- Heavy: Load less laundry, select a programme with prewash
- Stains: Remove/pretreat stains while they are fresh. Firstly, dab with soapy water; do not rub. Then wash the items of laundry with the appropriate programme. Stubborn or dried-in stains can sometimes only be removed by washing several times.

- Symbols on the care labels:

Note: The numbers in the symbols indicate the maximum washing temperature which may be used.

	Suitable for normal washing process; e.g. Cottons programme
	A gentle washing process is required; e.g. Easy-Care programme
	An especially gentle washing process is required; e.g. Delicate/Silk programme
	Suitable for washing by hand; e.g.  Woollens programme
	Do not machine wash.

DETERGENT

Correct selection of detergent

The care label is crucial for selecting the correct detergent, temperature and treatment of the laundry.

If you visit www.cleanright.eu, you will find further information on detergents, care products and cleaning agents for domestic use.

Note: Only use detergents for frontloading washing machines, low suds/ detergent foam.

- **Standard detergent with optical brighteners**

Suitable for boil-washable white laundry made from linen or cotton

Programme: Cottons/ cold - max. 90 °C

- **Detergent for colours without bleach or optical brighteners**

Suitable for coloured laundry made from linen or cotton

Programme: Cottons/ cold - max. 60 °C

- **Detergent for colours/delicates without optical brighteners**

Suitable for coloured laundry made from easy-care fibres, synthetic fibres

Programme: Easy-Care/ cold - max. 60 °C

- **Detergent for delicates**

Suitable for delicate, fine fabrics, silk or viscose

Programme: Delicate/Silk/ cold - max. 40 °C

- **Detergent for woollens**

Suitable for wool

Programme: Wool/ cold - max. 40 °C

Saving energy and detergent

For light and normal soiling, you can save energy (lower washing temperature) and detergent.

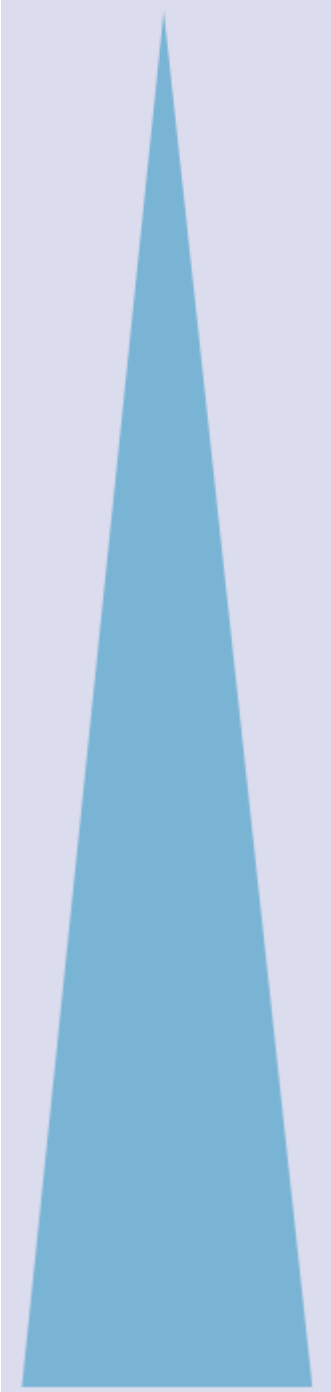





Saving	Soiling/note
<p>Reduced temperature and detergent quantity as per the recommended dosage</p>  <p>Temperature as per the care label and detergent quantity as per the recommended dosage for heavy soiling</p>	<p>Light</p> <ul style="list-style-type: none"> ■ Light summer/sports clothing (worn for a few hours) ■ T-shirts, shirts, blouses (worn for up to one day) ■ Guest bed linen and hand towels (used for one day) <p>Normal</p> <p>Visible dirt or a few light stains, e.g.:</p> <ul style="list-style-type: none"> ■ T-shirts, shirts, blouses (sweat soaked, worn a few times) ■ Towels, bedding (used for up to one week) <p>Heavy</p> <p>Dirt and/or stains clearly visible, e.g. tea towels, baby items, work clothing</p>

Note: When measuring the amount of all detergents/additives/care products and cleaning agents, please always check the manufacturer's instructions and information.





OVERVIEW OF PROGRAMMES

Programmes on the programme selector

Programme/type of laundry/information	Settings
<p>Programme name</p> <p>Brief explanation of the programme and for which fabrics it is suitable.</p>	<p>Max. load</p> <p>Temperature that can be selected (☼ = cold)</p> <p>Spin speed that can be selected**; ☾ = Rinse Stop</p> <p>Additional programme settings that can be selected</p>
<p>Cottons</p> <p>Hard-wearing fabrics, heat-resistant fabrics made of cotton or linen;</p> <p>Cottons + Prewash: Programme with prewash; divide the detergent between compartments I and II</p> <p>Notes</p> <ul style="list-style-type: none"> ■ For the ecoPerfect ☼ setting, the wash temperature is lower than the selected temperature. If you would like to set a particular washing temperature, use the programme without the ecoPerfect ☼ setting or, if necessary, set a higher temperature. ■ The speedPerfect ☾ setting is suitable as a short programme for lightly soiled laundry. 	<p>Max. 8 kg/5* kg</p> <p>☼ - 90 °C</p> <p>☾ - 1600** rpm</p> <p>ecoPerfect ☼, speedPerfect ☾, Less Ironing, Rinse Plus</p>
<p>Easy Care</p> <p>Synthetic or blended fabrics;</p> <p>Easy Care + Prewash: Programme with prewash; divide the detergent between compartments I and II</p>	<p>Max. 4 kg</p> <p>☼ - 60 °C</p> <p>☾ - 1200 rpm</p> <p>ecoPerfect ☼, speedPerfect ☾, Less Ironing, Rinse Plus</p>
<p>Mixed Load</p> <p>Mixed load of cottons and synthetic fabrics</p>	<p>Max. 4 kg</p> <p>☼ - 40 °C</p> <p>☾ - 1600** rpm</p> <p>ecoPerfect ☼, speedPerfect ☾, Less Ironing, Rinse Plus</p>
<p>* Reduced load for the speedPerfect ☾ setting</p> <p>** Max. spin speed, depending on the model</p> <p>*** Programme depending on the model</p>	

<p>Delicates / Silk</p> <p>For delicate, washable fabrics, e.g. made of silk, satin, synthetic fibres or blends (e.g. silk blouses, silk scarves)</p> <p>Note: Use a detergent suitable for machine-washing delicates or silk.</p>	<p>Max. 2 kg</p> <p>✳ - 40 °C</p> <p>☪ - 800 rpm</p> <p>ecoPerfect , speedPerfect , Less Ironing, Rinse Plus</p>
<p> Wool</p> <p>Hand- or machine-washable fabrics that are made of wool or contain wool; particularly gentle wash programme to prevent laundry from shrinking, with longer pauses in the programme (during which the items rest in the water)</p> <p>Notes</p> <ul style="list-style-type: none"> ■ Wool is of animal origin, e.g.: Angora, alpaca, llama, sheep. ■ Use a detergent that is suitable for machine-washing wool. 	<p>Max. 2 kg</p> <p>✳ - 40 °C</p> <p>☪ - 800 rpm</p> <p>-</p>
<p>Drain</p> <p>For the rinsing water, e.g. after the ☪ setting (Rinse Stop = no final spin cycle)</p>	<p>-</p> <p>-</p> <p>-</p> <p>-</p>
<p>Rinse / Spin</p> <p>Extra rinse/spin with speed that can be selected</p> <p>Note: The Rinse Plus button is set by default for this programme. If you require a spin cycle only, press the button to deactivate the function.</p>	<p>-</p> <p>-</p> <p>☪ - 1600** rpm</p> <p>Less Ironing</p>
<p>SuperQuick 15'</p> <p>Extra-short programme of approx. 15 minutes, suitable for small items of lightly soiled laundry</p>	<p>Max. 2 kg</p> <p>✳ - 40 °C</p> <p>400 - 1200 rpm</p> <p>-</p>
<p>*** Dark Wash</p> <p>Dark-coloured cottons and dark-coloured easy-care fabrics; turn items inside-out before washing.</p>	<p>Max. 3.5 kg</p> <p>✳ - 40 °C</p> <p>☪ - 1200 rpm</p> <p>ecoPerfect , speedPerfect , Less Ironing, Rinse Plus</p>
<p>* Reduced load for the speedPerfect  setting</p> <p>** Max. spin speed, depending on the model</p> <p>*** Programme depending on the model</p>	

<p>*** Hygienic</p> <p>Hard-wearing fabrics made of cotton or linen</p> <p>Note: Particularly suited to washing items that need to be hygienically clean and especially kind to sensitive skin thanks to the longer wash cycle at a defined temperature, higher water level and longer spin cycle.</p>	<p>Max. 7 kg/5* kg</p> <p>☼ - 60 °C</p> <p>☪ - 1600** rpm</p> <p>ecoPerfect ☉, speedPerfect ≡☉, Less Ironing, Rinse Plus</p>
<p>*** Outdoor / Impregnation</p> <p>Wash cycle followed by waterproofing of membrane-coated weatherproof and outdoor clothing or water-resistant fabrics</p> <ol style="list-style-type: none"> 1. Select a programme. 2. Add special detergent for outdoor clothing to compartment II. 3. Add waterproofing agent (max. 170 ml) to compartment ☼. 4. Press the ►II button. After-treat the laundry in accordance with the manufacturer's instructions. <p>Notes</p> <ul style="list-style-type: none"> ■ Use a special detergent suitable for machine washing and dose in accordance with the manufacturer's instructions: ■ Laundry must not be treated with fabric softener. ■ Before washing, clean the detergent drawer thoroughly (all compartments) to remove fabric-softener residue. 	<p>Max. 1 kg</p> <p>☼ - 40 °C</p> <p>☪ - 800 rpm</p> <p>ecoPerfect ☉, speedPerfect ≡☉, Rinse Plus</p>
<p>*** Outdoor</p> <p>Membrane-coated weatherproof or outdoor clothing and water-resistant fabrics</p> <p>Notes</p> <ul style="list-style-type: none"> ■ Use special detergent suitable for machine washing; add the correct dosage to compartment II in accordance with the manufacturer's instructions. ■ Laundry must not be treated with fabric softener. ■ Before washing, clean the detergent drawer thoroughly (all compartments) to remove fabric-softener residue. 	<p>Max. 2 kg</p> <p>☼ - 40 °C</p> <p>☪ - 800 rpm</p> <p>ecoPerfect ☉, speedPerfect ≡☉, Rinse Plus</p>
<p>*** Sports / Fitness</p> <p>Sportswear and leisurewear made from microfibre fabrics;</p> <p>Notes</p> <ul style="list-style-type: none"> ■ Laundry must not be treated with fabric softener. ■ Before washing, clean the detergent drawer thoroughly (all compartments) to remove fabric-softener residue. 	<p>Max. 2 kg</p> <p>☼ - 40 °C</p> <p>☪ - 800 rpm</p> <p>ecoPerfect ☉, speedPerfect ≡☉, Less Ironing, Rinse Plus</p>
<p>* Reduced load for the speedPerfect ≡☉ setting</p> <p>** Max. spin speed, depending on the model</p> <p>*** Programme depending on the model</p>	

<p>*** Quilts</p> <p>Machine-washable items stuffed with synthetic fibres, such as pillows, quilts and bedspreads; also suitable for items stuffed with down</p> <p>Note: Wash large items separately. Use a detergent designed for delicates and follow the instructions on the item's care label. Use detergent sparingly.</p>	<p>Max. 2.5 kg</p> <p>✳ - 60 °C</p> <p>☪ - 1200 rpm</p> <p>ecoPerfect , speedPerfect , Rinse Plus</p>
<p>Shirts / Blouses</p> <p>Non-iron shirts or blouses made of cotton, linen, synthetic fibres or blended fabrics</p> <p>Notes</p> <ul style="list-style-type: none"> ■ Shirts/blouses are only given a short spin on the Less Ironing setting. Hang them up to dry while still dripping wet. -> Self-smoothing effect ■ Use the Delicates / Silk programme to wash shirts/blouses made of silk or delicate fabrics. 	<p>Max. 2 kg</p> <p>✳ - 60 °C</p> <p>☪ - 800 rpm</p> <p>ecoPerfect , speedPerfect , Less Ironing, Rinse Plus</p>
<p>* Reduced load for the speedPerfect  setting</p> <p>** Max. spin speed, depending on the model</p> <p>*** Programme depending on the model</p>	

Starching

Note: Laundry must not be treated with fabric softener.

Starching is possible in all wash programmes if liquid starch is used. Measure starch into

compartment  in accordance with the manufacturer's instructions (clean first if necessary).

Dyeing/bleaching

Dye should only be used in normal household quantities. Salt may damage stainless steel. Always follow the dye manufacturer's instructions.

Do **not** use the washing machine to bleach clothes.

Soaking

1. Switch on the appliance
2. Select the Cottons 30 °C programme.
3. Pour soaking agent/detergent into compartment II in accordance with the manufacturer's instructions.
4. Press the ►|| button. The programme starts.
5. After approx. 10 minutes, press the ►|| button to pause the programme
6. Leave the laundry to soak for as long as required, then either press the ►|| button again to continue the programme or change the programme.

Notes

- Load laundry of the same colour.

- No additional detergent is required; the soaking solution is used for washing.

PROGRAM DEFAULT SETTINGS

The default programme settings are displayed in the display panel after selecting the programme.

You can change the default settings.

An overview of all programme settings, which can be selected depending on the programme

Temperature

(Temp. ° C)

Depending on what stage the programme is in, you can change the set temperature before and during the programme.

The maximum temperature that can be set depends on the programme that has been selected.

Spin speed

(rpm )

Depending on what stage the programme is in, you can change the spin speed (in rpm; revolutions per minute) before and during the programme.

Setting : Rinse Stop = no final spin. The laundry stays in the water after the final rinse.

You can select "Rinse Stop" to prevent creasing if the laundry will not be taken out of the washing machine immediately after the programme has ended.

The maximum speed that can be set depends on the model and programme that has been selected.

Finish in

Before starting the programme, you can preselect the programme end ("Finish in" time) in hourly increments (h = hour) up to a maximum of 24 hours.

To do this:

1. Select a programme. The programme duration is displayed for the selected programme, e.g. 2:30 hours:minutes).
2. Press the Finish in button repeatedly until the required number of hours is displayed.
Note: The setting values are increased using the **Finish in +** button, and decreased using the **Finish in -** button.
3. Press the  button. The programme starts. The selected number of hours e.g. 8 h) is shown in the display panel and counts down until the wash programme starts. The duration of the programme is then displayed.

After starting the programme if a Finish in time has been selected and the wash programme has not yet started), you can change the preselected number of hours as follows:

1. Press the ►|| button.
2. Use the **Finish in** - or + button to change the number of hours.
3. Press the ►|| button.

After starting the programme, you can add or remove laundry if necessary

ADDITIONAL PROGRAMME SETTINGS

An overview of all additional settings, d which can be selected depending on the programme, can be found from.

EcoPerfect

Energy-optimised washing by reducing the temperature while achieving a washing result that is

consistent with the selected programme, without the ecoPerfect  setting.

SpeedPerfect

Washing in a shorter time while achieving a washing result that is consistent with, but uses more energy than, the selected programme, without the speedPerfect  setting.

Less Ironing

Reduces creasing thanks to a special spin sequence followed by fluffing and reduced spin speed.

Note: The washing's residual moisture is increased.

Rinse Plus

Additional rinse cycle for particularly sensitive skin and/or for areas with very soft water.

OPERATING THE APPLIANCE

Preparing the washing rep machine

Notes: The washing machine must be correctly installed and connected.

1. Connect the mains plug.
2. Turn on the tap.
3. Open the door.

4. Check that the drum is completely drained. Drain if necessary.

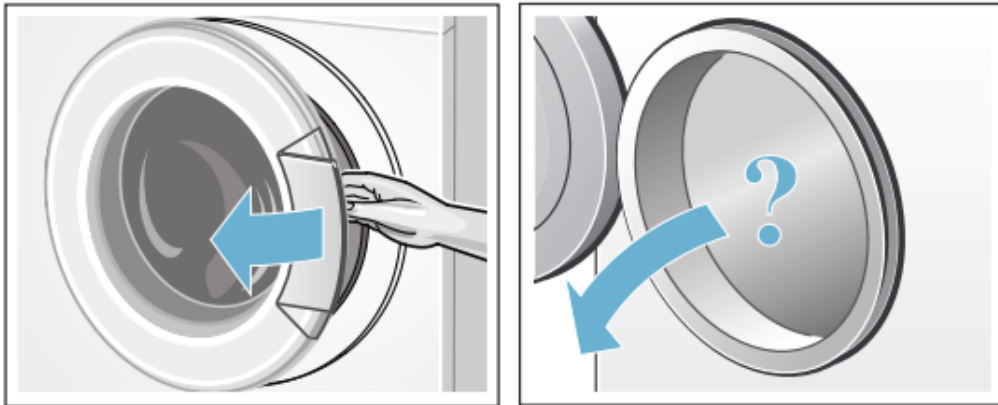

Switching on the appliance/ selecting a programme

Press the  button. The appliance is switched on.

The **Cottons** programme set at the factory is then always displayed.

You can use this programme or select a different programme. The programme selector can be turned in either direction.

Note: If you have activated the childproof lock, you must deactivate it before you can set a different programme.

The indicator lamp on the programme selector lights up and the default programme settings for the selected programme appear in the display panel:

- Temperature
- Spin speed and
- The maximum load and the duration of the programme (alternately)

In appliances with a **drum light**:

The drum is lit after switching on the appliance, after opening and closing the door and after starting the programme.

The light switches off automatically.

Placing laundry into the drum

Warning Danger of death!

Items of laundry pretreated with cleaning agents that contain solvents, e.g. stain remover/cleaning solvent, may cause an explosion after being loaded into the washing machine. Hand-rinse these items of laundry thoroughly beforehand.

Notes

- Mix items of laundry of varying sizes. Laundry items of different sizes distribute themselves better during the spin cycle. Individual laundry items may cause an unbalanced load.
 - Observe the maximum specified load. Overfilling adversely affects the washing result and promotes creasing.
1. Unfold presorted laundry items and place them in the drum.
 2. Make sure that no items of laundry are trapped between the door and the rubber seal, and close the door.

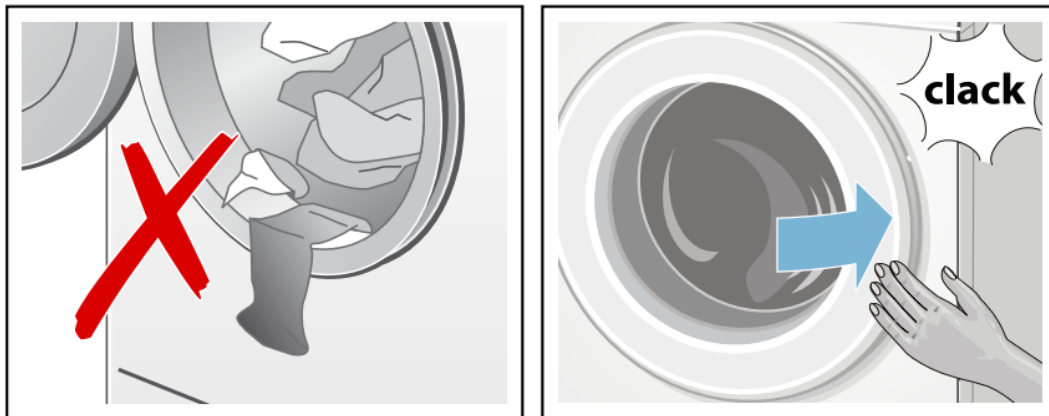

The  button indicator lamp flashes and the programme settings appear in the display panel.

Measure and add detergent and care products

Caution! Damage to the appliance

Cleaning agents and agents for pretreating laundry (e.g. stain removers, prewash sprays, etc.) may cause damage if they come into contact with the surfaces of the washing machine. Do not allow these agents to come into contact with the surfaces of the washing machine. If necessary, immediately wipe away spray residue and other residues/ droplets with a damp cloth.

Dosing

Dose the detergents and care products according to:

- Water hardness (ask your water supply company)
- The manufacturer's instructions on the packaging
- The amount of laundry
- Soiling

Filling

Warning! Eye/skin irritation!

Detergents and care products may spray out if the detergent drawer is opened while the machine is in operation.

Open the drawer carefully.

Rinse eyes/skin thoroughly if they come into contact with detergents or care products.

If accidentally swallowed, seek medical advice.

Note: Dilute viscous fabric softener and fabric conditioner with a little water. This prevents blockages in the washing machine's piping.

Pour the detergent and care products into the appropriate compartments:

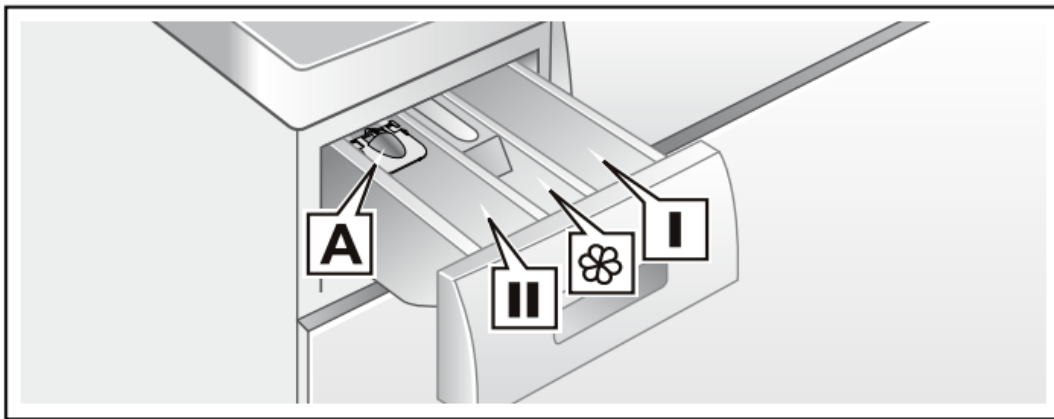

Measuring aid A For liquid detergent

Compartment I Detergent for prewash

Compartment  Fabric softener, liquid starch; do not exceed max.

Compartment II Detergent for the main wash, water softener, bleach, stain remover

1. Pull out the detergent drawer as far as possible.
2. Add detergent and/or care products.
3. Close the detergent drawer.

Measuring aid* for liquid detergent depending on the model

Position the measuring aid for dosing the correct amount of liquid detergent:

1. Pull out the detergent drawer. Press down the insert and fully remove the drawer.
2. Slide the measuring aid forwards, fold it down and click it into place.
3. Reinsert the drawer.

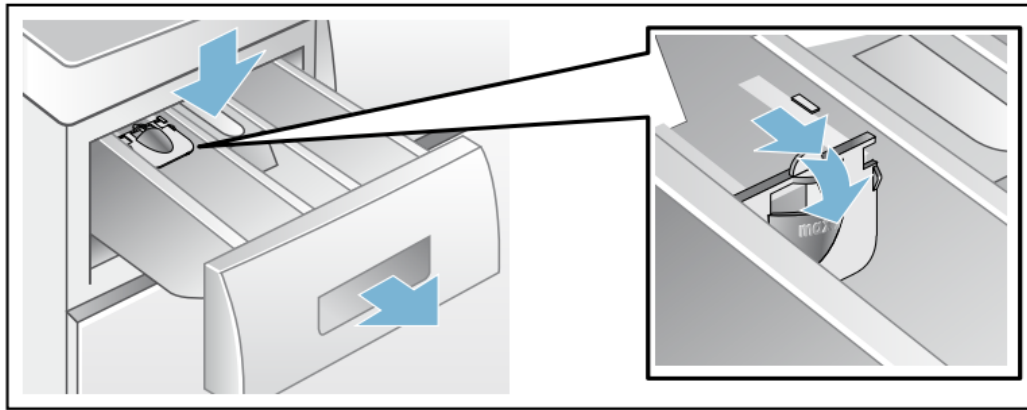

Note: Do not use the measuring aid for gel detergents and washing powder, or for programmes with prewash or when the “Finish in” time is selected.

For models without a measuring aid, pour the liquid detergent into the appropriate dispenser and place it in the drum.

Change the programme default settings

You can use or change the default settings for this washing cycle.

To do this, repeatedly press the corresponding button until the required setting is displayed.

Note: Pressing and holding the button automatically runs through the set values to the end. Then press the button once more and you can then change the setting values again.

The settings are activated without needing to be confirmed.

The settings are not saved after switching off the washing machine.

Select additional programme settings

By selecting additional settings, you can better adapt the washing process to your items of laundry.

The settings can be selected or deselected depending on the programme progress.

The button indicator lamps light up if a setting is activated.

The settings are not saved after switching off the washing machine.

Start the programme

Press the ►|| button. The indicator lamp lights up and the programme starts.

The display panel shows the "Ready in" time while the programme is running or the programme length and the programme progress symbols when the washing programme has started.

Note: Foam detection

If the  symbol also lights up in the display panel, the washing machine has detected too much foam during the wash programme and automatically activated additional rinse cycles to remove the foam.

Add less detergent to the next washing cycle with the same load.



If you want to lock the programme to prevent it from being inadvertently adjusted, you can select the childproof lock as follows.

Childproof lock

( 3 sec.)

You can lock the washing machine to prevent the functions you have set from being changed inadvertently. To do this, activate the childproof lock.

To activate/deactivate, press and hold the Finish in - and + buttons at the same time for approx. three seconds. The  symbol is appears in the display panel.

-  lights up: The childproof lock is active.
-  flashes briefly: The childproof lock is active and the programme selector was turned or a button was pressed.

Note: The childproof lock remains active, even once the washing machine has been switched off. Before selecting the next programme, deactivate the childproof lock.

Adding laundry

After starting the programme, you can add or remove laundry if necessary.

Press the  button to do this.

The  button indicator lamp flashes and the machine checks whether it is possible to add laundry.

If the following appears in the display panel:

- Both the - P - and  symbols light up, it is possible to add laundry.
- - P - lights up, it is not possible to add laundry.

To continue the programme, press the  button. The programme continues automatically.



Notes

- Do not leave the door open for too long when adding laundry as water from the laundry may leak out.
- For safety reasons, the door remains locked when the water level or temperature is high, or while the drum is turning, and it is not possible to add laundry during this time.

- The load display is not active during reloading.



Changing the programme

If you have started the wrong programme by mistake, you can change the programme as follows:



1. Press the  button.
2. Select another programme.
3. Press the  button. The new programme starts from the beginning.

Cancel the programme

For programmes at high temperatures:

1. Press the  button.
2. To cool down laundry: Select Rinse.
3. Press the  button.



For programmes at low temperatures:

1. Press the  button.
2. Select Spin or Drain.
3. Press the  button.



Programme end during rinse hold

In the display panel,  flashes, and the preset spin speed and remaining programme length are displayed for the selected programme.

Continue the programme by:

- Pressing the  button or
- Changing the spin speed, or setting the programme selector to Drain and then pressing the  button.

Programme end

- 0 - and  appear in the display panel. The  button indicator lamp is off.

Removing laundry/switching off the appliance

1. Open the door and remove the laundry.
2. Press the  button. The appliance is switched off.
3. Turn off the tap. **Note:** Not required for Aqua-Stop models.

Notes

- Do not leave any items of laundry in the drum. They may shrink in the next wash or discolour another item.
- Remove any foreign objects from the drum and the rubber seal – risk of rusting.
- Wipe the rubber seal dry.

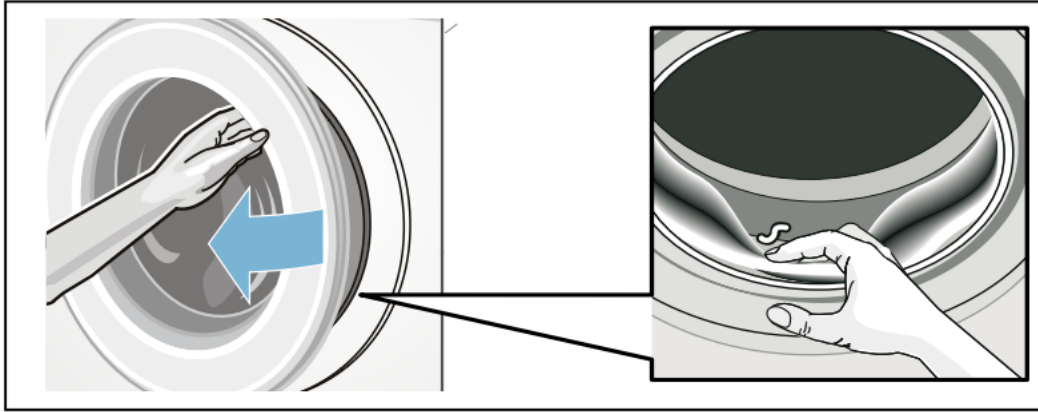

- Leave the door and detergent drawer open so that any residual water can evaporate.
- Always wait until the programme ends, as the appliance could still be locked. Then switch the appliance on and wait for it to unlock.
- If the display panel goes off at the end of a programme, the energysaving mode is active. Press any button to activate the panel.

APPLIANCE SETTINGS

You can change the following settings:

- The volume of the buttons and information signals (e.g. at the end of the programme)
- Select/deselect the appliance's automatic switch-off function.

You will need to activate the setting mode in order to change these settings.

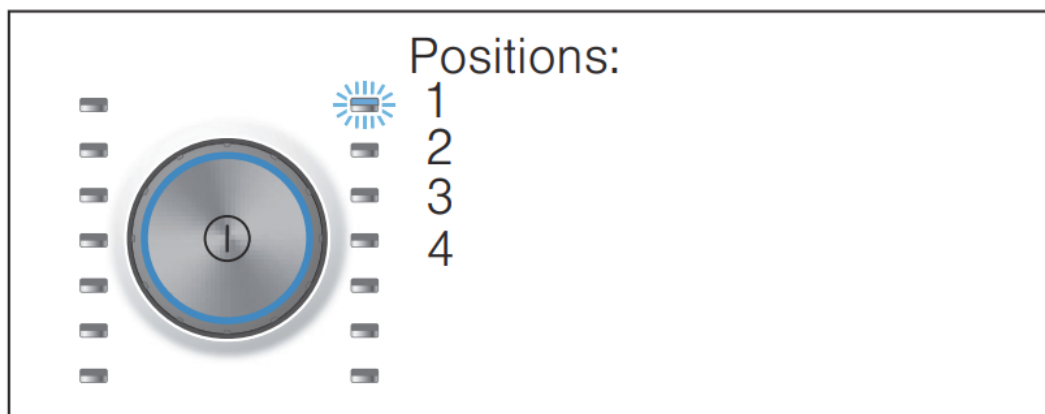

Activating the setting mode

1. Press the ① button. The appliance is switched on and the Cottons programme is shown at position 1.
2. Press the Temperature button and, at the same time, turn the programme selector clockwise to position 2. Release the button.

The setting mode is activated and the preset volume for the information signals appears in the display panel.

You can now change the settings:

Changing the signal volume

Use the Finish in + or - button to change the following settings at the corresponding programme selector positions:

- 2: The volume of the information signals and/or
- 3: The volume of the button signals.



0 = off,
1 = quiet,
2 = medium,
3 = loud,
4 = very loud

Exit setting mode or:

Selecting/deselecting the appliance automatic switchoff

With the programme selector in position 4 press the Finish in + or - button to switch the "Automatic switch-off" function on or off.

Exiting setting mode

To exit and save the settings, press the ① button.

The appliance is switched off. The selected settings will take effect the next time the washing machine is switched on.

SENSORS

Automatic load sensing

Depending on the type of fabric and load, the automatic load sensing function optimally adjusts the water consumption and programme duration in each programme.

Unbalanced load detection system

The automatic unbalanced load detection system detects imbalances and ensures even distribution of the laundry by repeatedly starting and stopping drum spinning.

If the laundry is extremely unevenly distributed, the speed is reduced or the spin cycle is not performed for safety reasons.

Note: Place large and small items of laundry evenly in the drum.

AquaSensor

depending on the model

During the rinse cycle, the AquaSensor checks the degree of turbidity (turbidity is caused by dirt and detergent residue) of the rinsing water. The duration and the number of rinse cycles depend on the turbidity of the water.

CLEANING AND MAINTENANCE

Warning Danger of death!

There is a risk of electric shock if you touch live components.

Switch off the appliance and unplug the mains plug.

Warning Risk of poisoning!

Toxic vapours can be produced by cleaning agents that contain solvents, e.g. cleaning solvent.

Do not use cleaning agents that contain solvents.

Caution! Damage to the appliance

Cleaning agents that contain solvents, e.g. cleaning solvent, can damage surfaces and components in the machine.

Do not use cleaning agents that contain solvents.

Prevent detergent residue from building up and odours from forming by following these instructions:

Notes

- Ensure the room in which the washing machine is set up is well ventilated.

- Leave the door and detergent dispenser tray open slightly when the washing machine is not in use.
- Occasionally run a wash using the Cottons 60 °C programme and powder detergent.

Machine housing/control panel

- Wipe the housing and the control panel with a soft, damp cloth.
- Remove the detergent residue immediately.
- Do not clean with a water jet.

Drum

Use chlorine-free cleaning agents, do not use steel wool.

If there are odours in the washing machine, or to clean the drum, run the Cottons 90 °C programme without laundry. Add washing powder.

Descaling

Descaling should not be necessary if the detergent is measured out correctly. However, if it is required, follow the manufacturer's instructions for the descaling agent. Suitable descalers can be obtained via our website or from customer services.

Detergent drawer and housing

If the washing machine contains detergent or fabric softener residues:

1. Pull out the detergent drawer. Press down the insert and fully remove the drawer.
2. To remove the insert: Push the insert upwards from below with your finger.

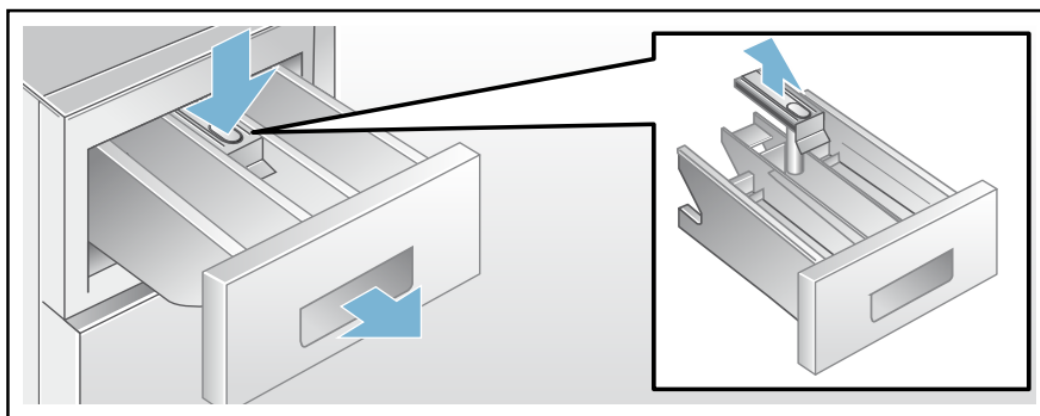

3. Clean the detergent dispenser tray and insert with water and a brush, and dry it. Clean the inside of the housing as well.
4. Fit the insert and lock it in place (push the cylinder onto the guide pin).

5. Push in the detergent drawer.

Note: Leave the detergent drawer open so that any residual water can evaporate.

The drain pump is blocked, emergency draining

Warning Risk of scalding!

When you wash at high temperatures, the water gets very hot. If you come into contact with the hot water, you may be scalded

Allow the water to cool down.

1. Turn off the tap so that no more water can flow in and has to be drained via the drain pump
2. Switch off the appliance. Pull out the mains plug.
3. Open and remove the service flap.

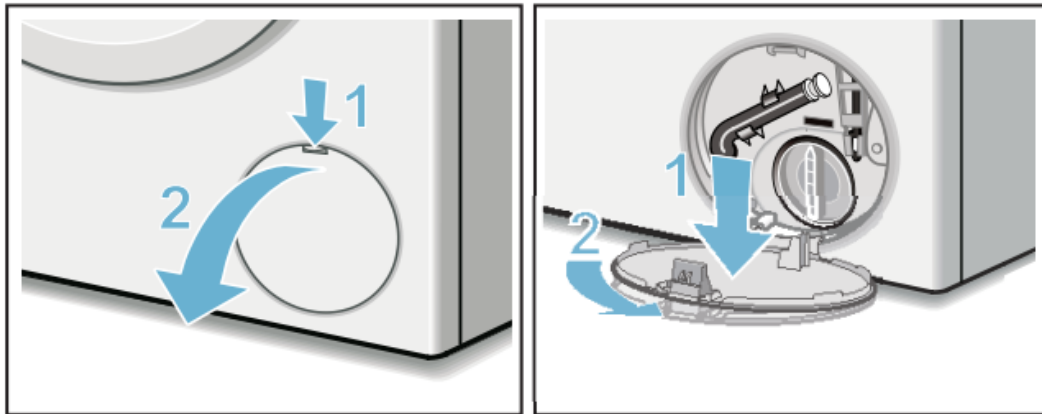

4. Take the drain hose out of the retainer.

Remove the sealing cap and pour the water out into a suitable container.

Replace the sealing cap and place the drain hose back in the retainer.

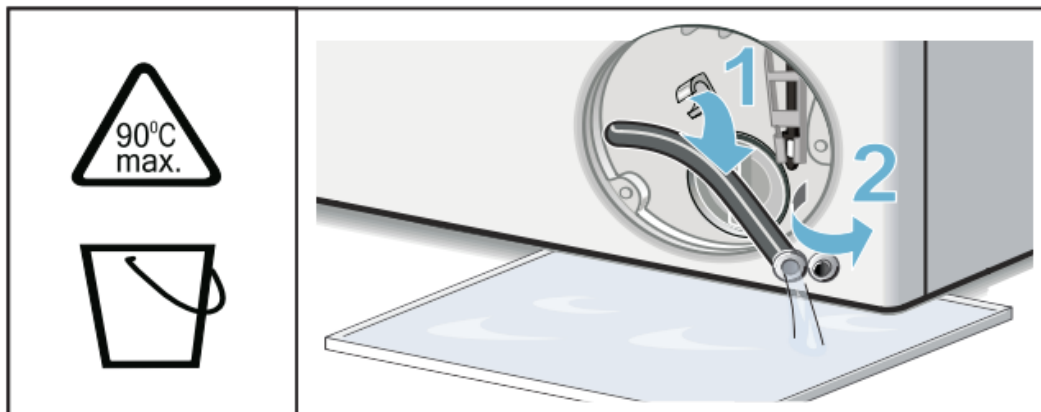

5. Carefully unscrew the pump cover; residual water may leak out.

Clean the interior, pump-cover thread and pump housing. The impeller in the drain pump must be able to rotate.

Refit the pump cover and screw it on tightly. The handle must be in a vertical position.

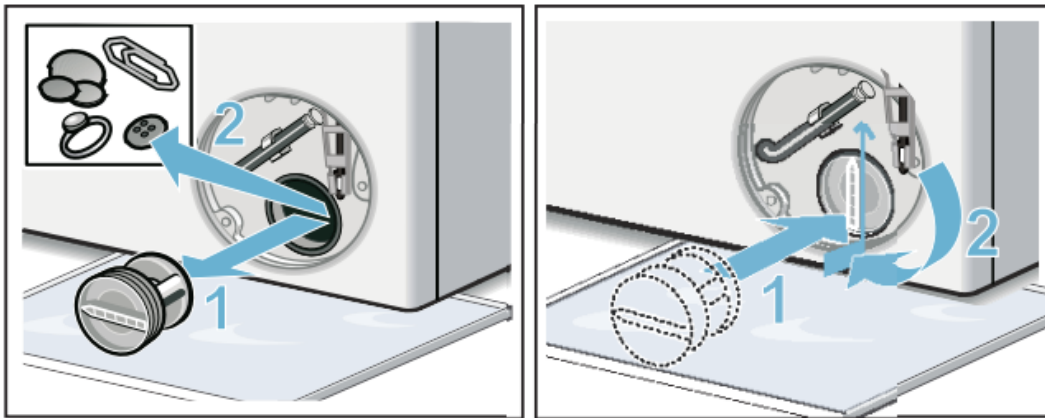

6. Place the service flap back on, lock it into place, and close it.

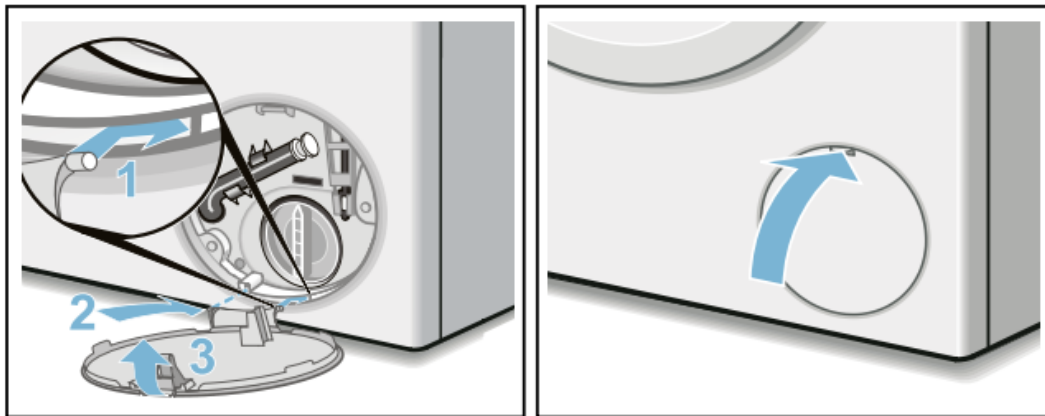

Note: To prevent unused detergent from flowing straight into the drain during the next wash: Pour 1 litre of water into compartment II and start the Drain programme.

The drain hose at the siphon is blocked

1. Switch off the appliance. Pull out the mains plug.
2. Loosen the hose clamp. Carefully remove the drain hose; residual water may leak out.
3. Clean the drain hose and siphon connecting piece.

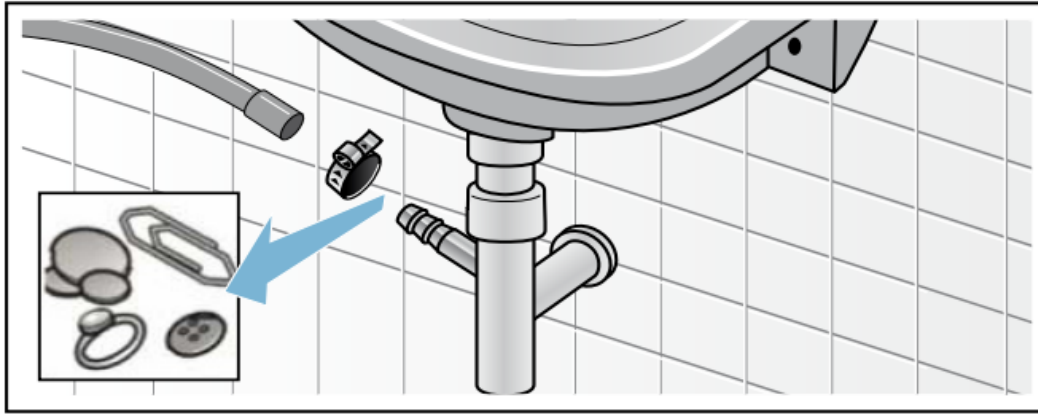

4. Re-attach the drain hose and secure the connection point using the hose clamp.

Filter in the water supply is blocked

First, reduce the water pressure in the supply hose:

1. Turn off the tap.
2. Select any programme (except Rinse/Spin/Empty).
3. Press the ▶|| button. Allow the programme to run for approximately 40 seconds.
4. Press the ⓘ button. The appliance is switched off.
5. Pull out the mains plug.

Then clean the filter:

1. Disconnect the hose from the tap. Clean the filter with a small brush.

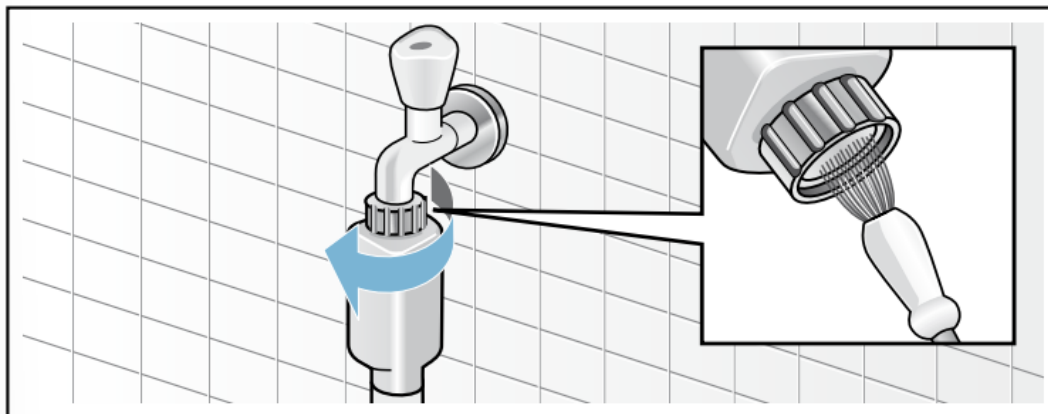

2. For standard and Aqua-Secure models, clean the filter on the rear of the appliance:

Remove the hose from the rear of the appliance.

Use pliers to remove the filter and then clean it.

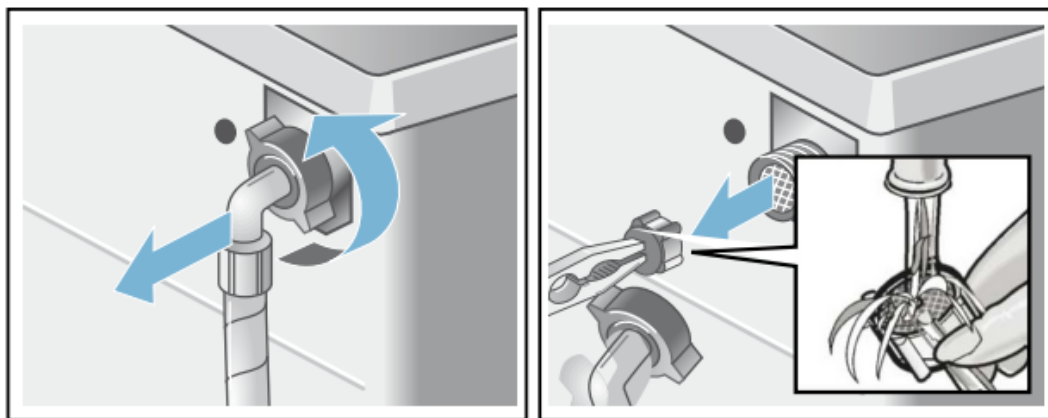

3. Connect the hose and check for leaks.

TROUBLESHOOTING

Emergency release

E.g. in the event of a power cut The programme continues when the power supply is restored.

However, if the laundry has to be removed, the washing machine door can be opened as follows:

Warning Risk of scalding!

When you are washing at high temperatures, there is a risk of scalding if you come into contact with hot water and laundry.

If possible, leave it to cool down first.

Warning Risk of injury!

You may injure your hands if you reach into the drum while it is turning.

Do not reach into the drum when it is turning.

Wait until the drum has stopped turning.

Caution! Water damage

Water damage

Any escaping water may cause water damage. Do not open the door if water can be seen through the glass.

1. Switch off the appliance. Pull out the mains plug.
2. Drain the water.
3. Pull the emergency release downwards with a tool and release.

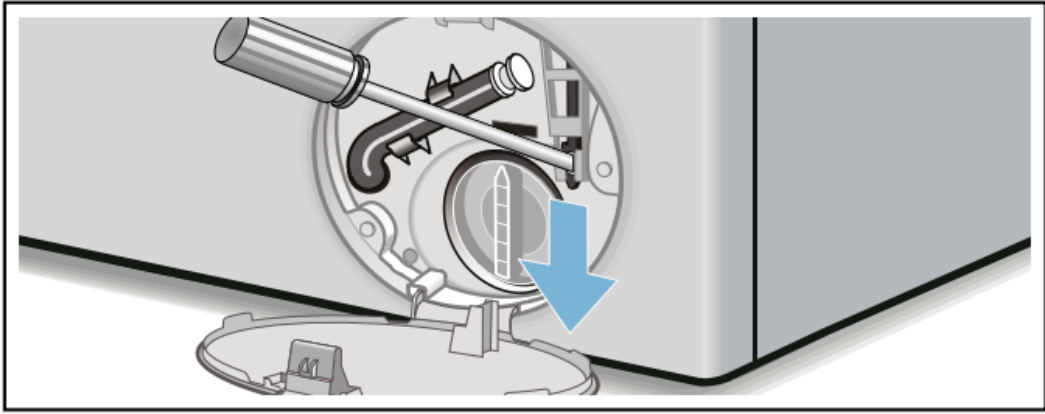

The door can then be opened.





Information on the display panel



Display	Cause/remedial action
- P - and 	The door is unlocked. It is possible to add laundry.
- P -	<ul style="list-style-type: none"> ■ The temperature is too high. Wait until the temperature drops. ■ The water level is too high. It is not possible to add laundry. Close the door immediately, if necessary. Press the ► button to continue the programme.
 flashes	<ul style="list-style-type: none"> ■ Laundry may be caught. Open and close the door again and press the ► button. ■ If necessary, push the door closed or remove some laundry and then push it closed again. ■ If necessary, switch the appliance off and on again; set the programme and make your individual settings; start the programme.
 lights up	<ul style="list-style-type: none"> ■ Turn on the tap fully, ■ Supply hose kinked/trapped, ■ The water pressure is too low. Clean the filter.
E:18	<ul style="list-style-type: none"> ■ The drain pump is blocked. Clean the drain pump. ■ The drain hose/drain pipe is blocked. Clean the drain hose at the siphon.
E:23	There is water in the base trough, the appliance is leaking. Turn off the tap. Call customer services.
	The childproof lock is activated - deactivate it.
 lights up	Too much foam has been detected and an additional rinse cycle has been activated. Add less detergent to the next washing cycle with the same load.

Display	Cause/remedial action
Other displays	Switch off the appliance, wait for five seconds and then switch it on again. If the display appears again, call customer services.
Water is leaking from the machine.	<ul style="list-style-type: none"> ■ Attach the drain hose correctly or replace it. ■ Tighten the screw fitting on the supply hose.
The machine is not filling with water. Detergent is not being dispensed.	<ul style="list-style-type: none"> ■ Have you pressed the ► button? ■ Is the tap turned on? ■ Could the filter be clogged? Clean the filter. ■ Is the supply hose kinked or trapped?
The door cannot be opened.	<ul style="list-style-type: none"> ■ The safety function is activated. Stop the programme? ■ Is  selected (Rinse Stop = no final spin)? ■ Can the door only be opened by the emergency release?
The programme will not start.	<ul style="list-style-type: none"> ■ Have you pressed the ► button or selected Finish in time? ■ Is the door closed? ■ Is the  childproof lock activated? Deactivate it.
The drum briefly jerks or judders after the programme has started.	Not a fault - the internal motor test may cause the drum to jerk or judder briefly when the wash programme starts.
The water is not draining.	<ul style="list-style-type: none"> ■ Is  selected (Rinse Stop = no final spin)? ■ Clean the drain pump. ■ Clean the drain pipe and/or the drain hose.

Display	Cause/remedial action
Water is not visible in the drum.	Not a fault - the water is below the visible area.
The spin result is not satisfactory. Laundry is wet/too damp.	<ul style="list-style-type: none"> ■ Not a fault - the unbalanced load detection system has interrupted the spin cycle because the laundry is unevenly distributed. Distribute small and large items of laundry evenly in the drum. ■ Is Less Ironing selected (depending on the model)? ■ Is the selected speed too low?
The spin cycle runs several times.	Not a fault - the unbalanced load detection system is adjusting an imbalance.
The programme is taking longer than usual.	<ul style="list-style-type: none"> ■ Not a fault - the unbalanced load detection system is adjusting an imbalance by repeatedly distributing the laundry. ■ Not a fault - the foam detection system is active - a rinse cycle has been switched on.
The length of the programme changes during the wash cycle.	Not a fault - the programme sequence is optimised for the specific washing process. This may change the length of the programme shown in the display panel.
Residual water in the care-product compartment 	<ul style="list-style-type: none"> ■ Not a fault - the effect of the care product is not affected. ■ Clean the insert if necessary.
Odours in the washing machine.	<p>Run the Cottons 90 °C programme without laundry.</p> <p>Add washing powder or a detergent containing bleach.</p> <p>Note: To prevent foaming, only use half of the amount of detergent recommended by the detergent manufacturer. Do not use detergents designed for woollens or delicates.</p>

Display	Cause/remedial action
<p>The  symbol lights up in the display panel. Foam may also be leaking from the detergent drawer.</p>	<p>Have you used too much detergent?</p> <p>Mix one tablespoon of fabric softener with 1/2 litre of water and pour it into compartment II (not suitable for outdoor clothing, sportswear or items stuffed with down).</p> <p>Use less detergent in the next washing cycle.</p>
<p>Loud noises, vibrations and machine "movement" during the spin cycle.</p>	<ul style="list-style-type: none"> ■ Is the appliance aligned? Align the appliance. ■ Are the appliance's feet fixed? Secure the appliance's feet. ■ Have the transport braces been removed? Remove the transport braces.
<p>The display panel/ indicator lamps do not work while the appliance is running.</p>	<ul style="list-style-type: none"> ■ Has there been a power failure? ■ Have the fuses blown? Reset/replace the fuses. ■ If the fault occurs repeatedly, call customer services.
<p>There is detergent residue on the laundry.</p>	<ul style="list-style-type: none"> ■ Some phosphate-free detergents contain water-insoluble residue. ■ Select Rinse or brush the laundry after washing.
<p>- P - appears in the display panel when the cycle is paused.</p>	<ul style="list-style-type: none"> ■ The water level is too high. It is not possible to add laundry. Close the door immediately, if necessary. ■ Press the ►II button to continue the programme.
<p>- P - and  appear in the display panel when the cycle is paused.</p>	<p>The door is unlocked. It is possible to add laundry.</p>
<p>If you cannot rectify a fault yourself (after switching the machine off and on again) or a repair is required:</p> <ul style="list-style-type: none"> ■ Switch off the appliance and pull out the mains plug. 	

Display	Cause/remedial action
	<ul style="list-style-type: none">■ Turn off the tap and call customer services.

Warning

This content is compiled from multiple sources and is provided for reference purposes only. It may not be complete or fully applicable to all situations. If you are unable to resolve your issue, please contact the product manufacturer or an authorized service provider for official support.

