

Installing your new appliance

- Before using the appliance for the first time, you should be informed of the following tips.
- Warning! For proper installation, this refrigerator must be placed on a level surface of hard material that is the same height as the rest of the flooring. This surface should be strong enough to support a fully loaded refrigerator.
- The rollers, which are not castors, should be only used for forward or backward movement. Moving the refrigerator sideways may damage your floor and the rollers.

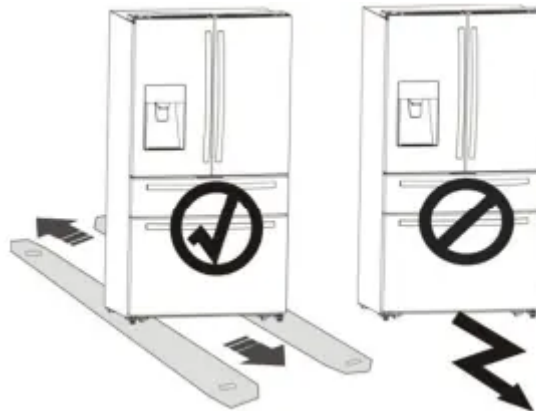

Ventilation of appliance

- In order to improve efficiency of the cooling system and save energy, it is necessary to maintain good ventilation around the appliance for the dissipation of heat. For this reason, sufficient clear space should be available around the refrigerator
- Suggest: It is advisable for there to be at least 75mm of space from the back to the wall, at least 100mm from its top, at least 100mm from its side to the wall and a clear space in front to allow the doors to open 130°. As shown in follow diagrams

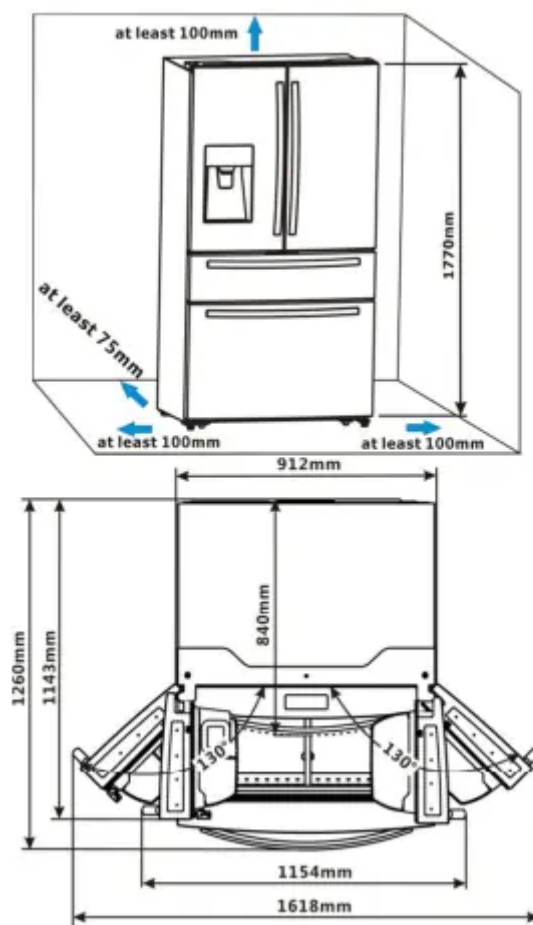

Note:

- This appliance performs well within the climate class from N to T showed in the table below. It may not work properly if being left at a temperature above or below the indicated range for a long period.

Climate class	Ambient temperature
SN	+10°C to +32°C
N	+16°C to +32°C
ST	+16°C to +38°C
T	+16°C to +43°C

- Stand your appliance in a dry place to avoid high moisture.
- Keep the appliance out of direct sunlight, rain or frost. Stand the appliance away from heat sources such as stoves, fires or heaters.

Leveling of appliance

- For sufficient leveling and air circulating in the lower rear section of the appliance, the bottom feet may need to be adjusted. You can adjust them manually by hand or by using a suitable spanner.
- To allow the doors to self-close, tilt the top backwards by 10-15 mm.

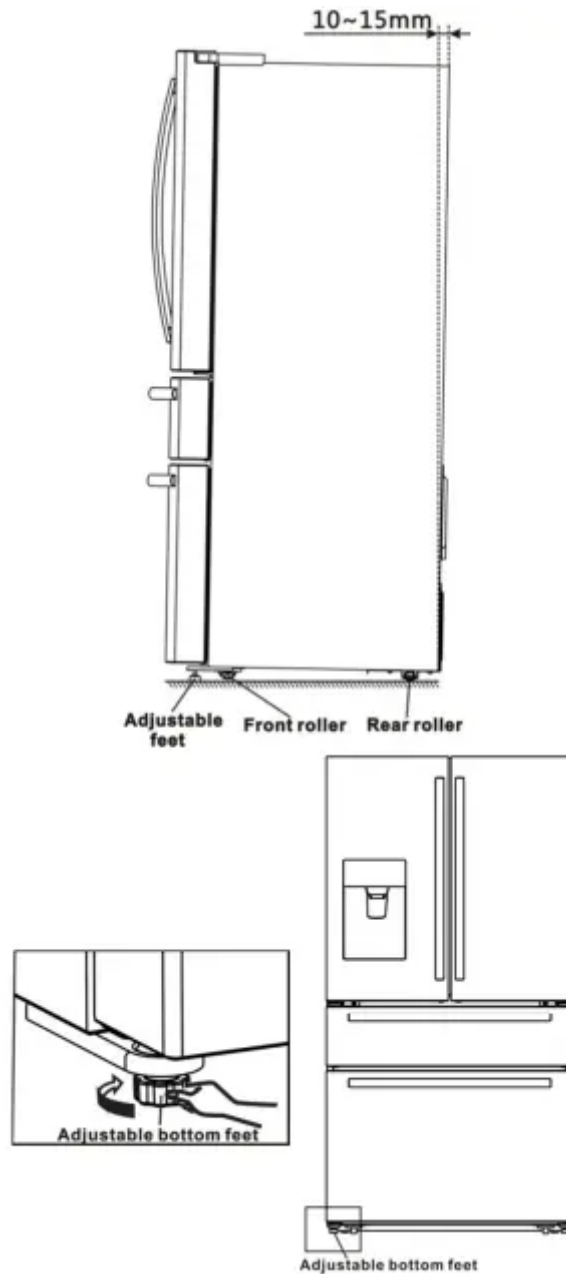



Doors removal

- In case when your access door is too narrow for the refrigerator to pass through, remove the refrigerator door and drawers. Then pass the refrigerator laterally. If you do not need to remove the appliance doors, go to 'Installing the water lines' on page 8. If you need to remove the doors, continue below.

- Warning! Disconnect power and shut off water supply to the fridge before removing the door or drawer. Failure to do so could result in death or serious injury.

The tools you will need (Not provided):

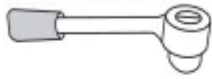
The tools you will need (Not provided):

	
Allen Wrench(5mm)	Wrench(8mm)
	
Philips screwdriver	

With the fridge doors opened

1. With the door closed, remove the 3 screws holding the top cover (A) with Philips (+) screwdriver, and then remove the top cover with the entire-harnesses attached.

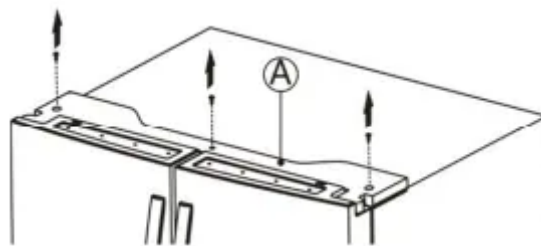

2. Separate the two connectors on the left side door. To remove the wire connector, press the top of the connector (B) and separate it from the other one. To remove the water coupler from the hinge, twist and pull the clips from the coupler. Remove the water line (C) while pressing the movable part (D) of the water line coupler.

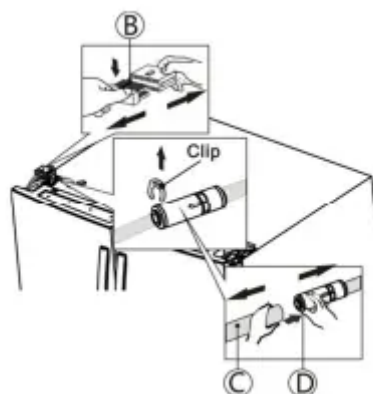

3. Remove the 3 screws (E) fixed on the hinges with a Wrench (8mm) and 1 ground screws (F) attached to the hinge with Philips (+) screwdriver. Remove the upper left and right door hinges (G).

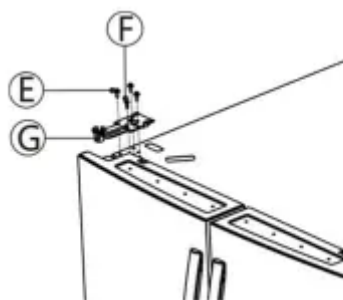

4. Use your both hands to open the door more than 90°. Lift it up and take it off.

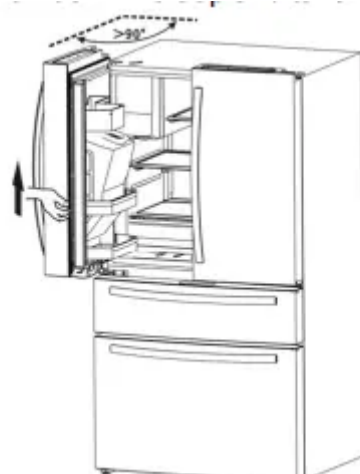

5. Remove the 4 hex head bolts hinges (I) with an Allen wrench (5 mm). Remove the lower left and right door hinges (J).

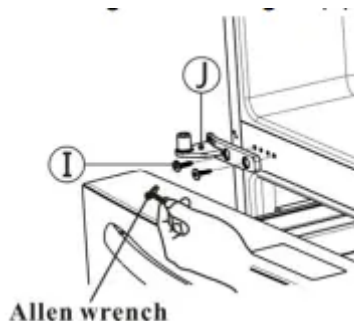

Re-attaching the fridge doors To reattach the fridge doors after you have moved the appliance to its final location, assemble the parts in reverse order.

1. To prevent water leaks, the water line should be fully inserted into the center of the coupler. The guide lines should be coincided exactly with the head of the movable part.

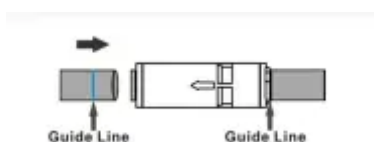

2. Make sure the clips are properly connected to the coupler.

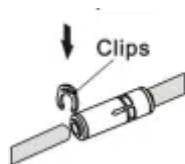

Caution! In case the fridge doors can't be self-closed, please make sure the door opened more than 90° when you remove or re-attaching the fridge doors.

Disassembling My Fresh Choice door

1. Take out My Fresh Choice drawer (A) in the direction of the arrow.

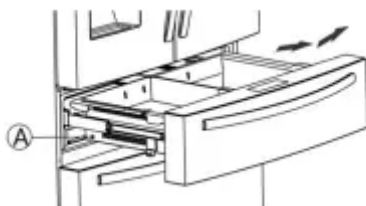

2. Remove the 2 screws (B) holding the wire nails with a Philips screwdriver (+).

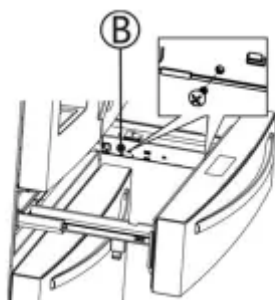

3. Take off the wire nails (C). To remove the wire connector, press the top of the connector (D) and separate it from the other one.

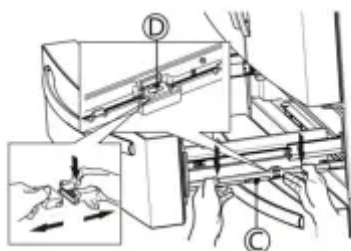

4. Remove the 2 screws attached to the supporting frame (E) with a Philips screwdriver (+).

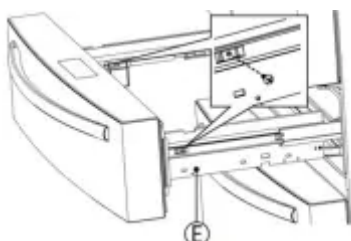

5. Pull out the My Fresh Choice door and lift it up in the direction of the arrow.



Re-assembling My Fresh Choice door

- To reattach My Fresh Choice door, assemble parts in reverse order.
- Note: Be sure to connect the variation door wire connector (E). If it is not connected, My Fresh Choice room does not work.

Disassembling the freezer door

1. Pull out the freezer door and the upper freezer drawer (A) to the final position.

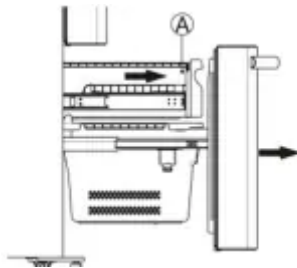

2. Take out the upper freezer drawer (A) by lifting it up in the direction of the arrow.



3. Take out the lower freezer drawer (B) by lifting it up from the rail system.



4. Remove the Pizza basket (C) by lifting it up.



5. Remove the 2 screws attached to the supporting frame (D).

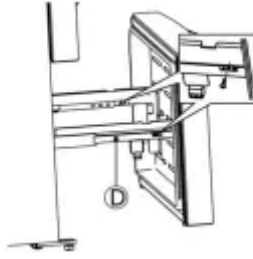

6. Pull out the freezer door and lift it up in the direction of the arrow.

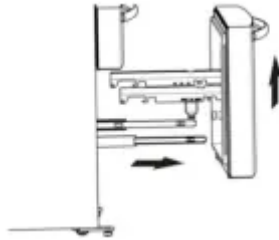

Re-assembling the freezer door: To reattach the drawer after you moved the appliance to its final location, assembling the parts in reverse order.

Installing the water lines: A water dispenser with a filter is one of the helpful features on your new appliance. To help promote better health, the water filter removes unwanted particles from your water. However, it does not sterilize or destroy microorganisms. You may need to purchase a water purifying system to do that. In order for the water dispenser/ice maker to operate properly, a water pressure of 207-862 kPa is required.



Warning:

- The water connection must be made by a qualified plumber. Operation outside the water pressure range may cause malfunction, severe and damaging water leaks.
- Under normal conditions, a 200ml (5.75 oz.) cup can be fill in about 10 seconds. If the refrigerator is installed in an area with low water pressure (blow 207kPa),you can install a booster pump to compensate for the low pressure.
- After you have connected the water line, make sure the water storage tank inside the refrigerator is properly filled. To do this, press the water dispenser lever until the water runs from the water outlet.

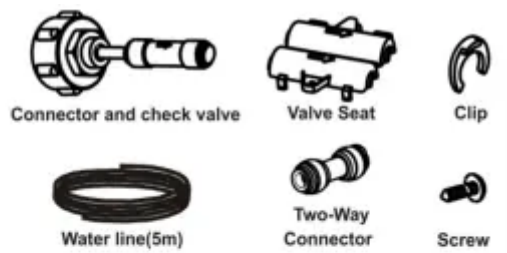
Parts for water line installation



The tools you will need:

	
Spanner (Provided)	Philips screwdriver (Not provided)

Connecting to the water supply line

- The connector and the check valve are provided as one part. You should use the new connector incidentally but not the old one you have.
- Caution! The water line must be connected to the cold water pipe.
- First, turn off the main water supply line. Screw the adaptor onto a suitable 3/4" BSP connector water outlet and use the spanner to tighten it. Fully insert the water line into the check valve. Then insert the clip in the install pack as the figure shown below.

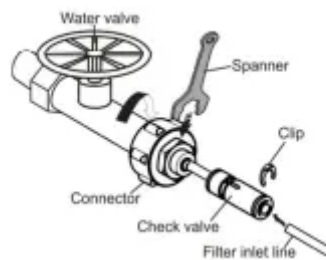

- To prevent the clips loose, use the valve seat to hold it. Then use the screw to hold the valve seat with Philips (+) screwdriver.

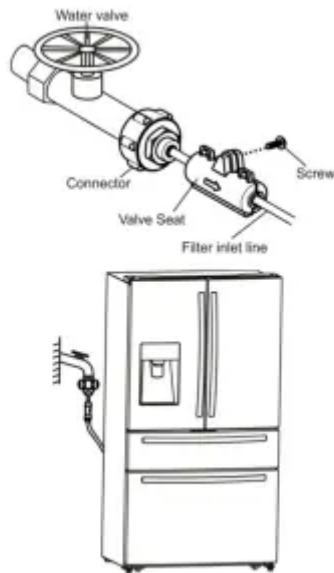

Note:

- Use only the new tubings supplied with the refrigerator. Old tubings should not be used.
- After connected to the water supply line, please open the water valve to flush the filter for 5 minutes before use.
- If the main supply line is too far away from the refrigerator to be connected to the filter inlet line, the water line (5m) provided may be helpful. The outlet line of the water filter should be connected with the inlet line of the refrigerator by a Two-Way Connector. The water line must be fully inserted into the center of the connector to prevent water leaking. Insert the 2 clips in the install pack as shown in the diagram, and then confirm that each clip holds the line firmly.

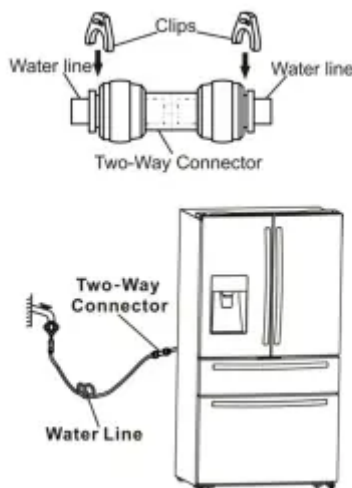

- The initial dark discoloration of water is normal.
- The water lines must be connected with the potable water only.
- The water lines should not be pressed by heavy things and should not bend too much.

- It is normal that there will be sound of exhaust comes out from the appliance when you connect the water line to the appliance and press the level of the dispenser for the first time.

Warning!

- After turning on the water valve, make sure that there is no leakage at all connection points of the water lines. If there is a leakage, turn off the valve immediately and tighten the water connector or make the lines fully inserted into the connector.
- The water line must be connected to the cold water pipe. If it is connected to the hot water pipe, it may cause the purifier to malfunction.
- Avoid contamination of pipes during installation.

Description of the appliance

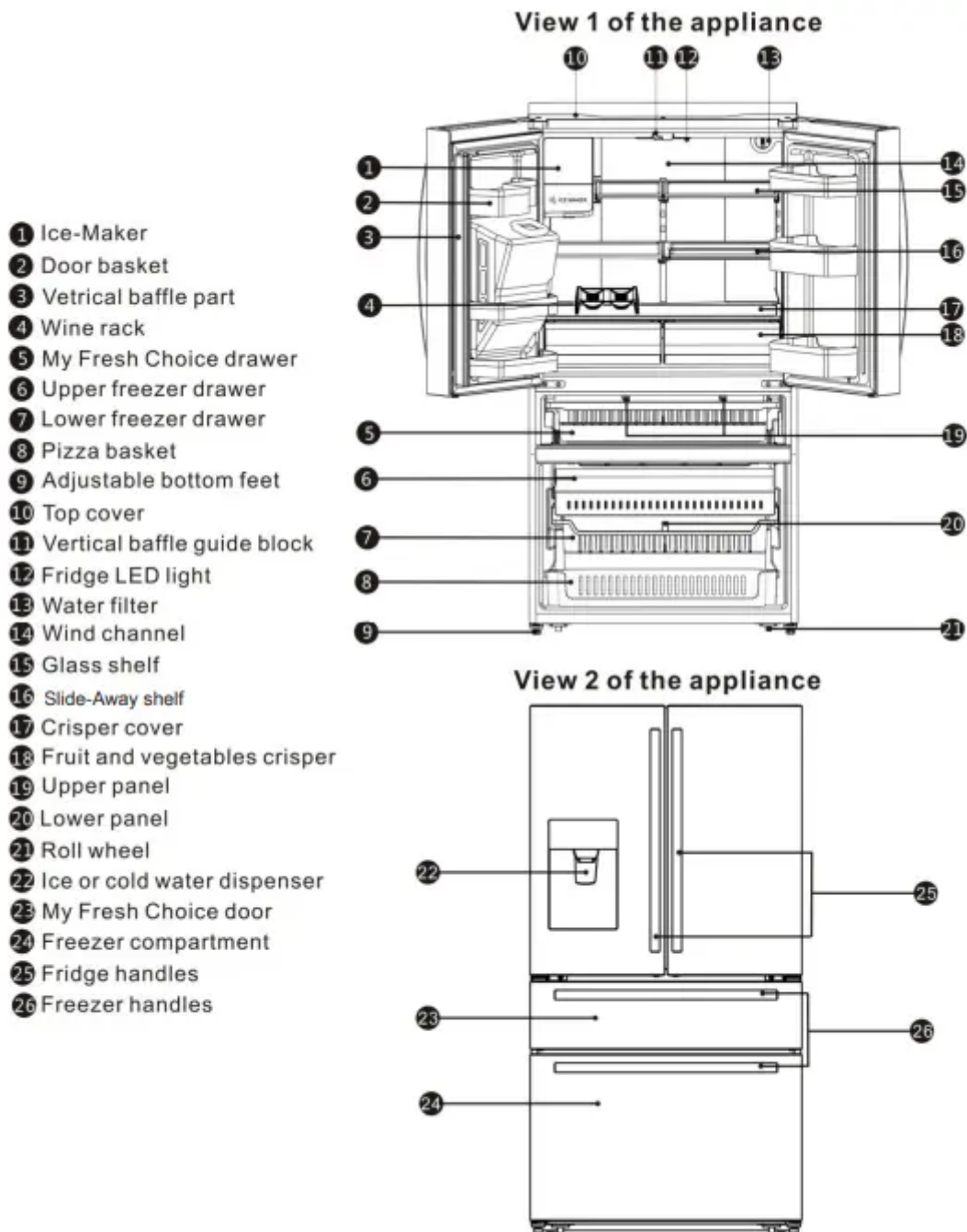

Display Controls

- Your product has two control panels, one is on the fridge door and the other is on My Fresh Choice door. Use your appliance according to the following control guidelines.
- Using the control panel on the fridge door
- The control panel on the fridge door shows in the diagram below.







- When the appliance is powered on for the first time, the backlighting of the icons on the display panel starts working. If no buttons have been touched and the doors are closed, the backlighting will turn off after 60 seconds.
- The control panel consists of two areas about temperature, and one area about different modes.

Caution! When you set a temperature, you set an average temperature for the whole refrigerator cabinet. Temperatures inside each compartment may vary from the temperatures displayed on the panel, depending on how much food you store and where you place it. High or low room temperature may also affect the actual temperature inside the appliance.



“Child Lock and Door Alarm”

This button serves two purposes:

1. Child Lock: Press and hold “Alarm” for 3 seconds to lock the all the Control Panel including dispenser function. If Control panel is locked, the icon “” will be on, and none of the buttons on the Control panel work. To unlock the Control panel, please press and hold “Alarm” for 3 seconds again.
2. Door Alarm:
 - In case of alarm, “” icon will be on and a buzzing sound will be heard. Touch “Alarm” key to clear alarm then the “” icon will turn off and the buzzing will stop. When the door of fridge, variation or freezer is open over 2 minutes, the door alarm will come on. In case of alarm, “” icon will be on and will be buzzing sound. The buzzer will sound 3 times per minute and will stop after 10 minutes. Also it can be stopped by closing the door. When Child Lock is off, and the doors are open, you can turn alarm off by touching “Alarm”.

- To save energy, please avoid keeping doors open for a long time when using refrigerator.



“Ice Control”

- This button controls the ice maker. You can touch “Ice Off” button to control the ice maker. When the Child Lock is off, and the ice function is on, you can touch the “Ice Off”

icon to lock the ice maker, and the icon “” will be illuminated. If you want to unlock

the ice maker, please touch the “Ice Off” icon again, and the icon “” will be off.

- Note: When the “Ice Off” is on, it only lock the ice maker not the dispenser.



“Holiday”

- If you are going to be away for a long period of time such as a long holiday or business trip, you can activate this function by touching the “Holiday” button, and the icon “” will be illuminated.

- When the holiday function is activated, the temperature of the fridge is automatically switched to 15°C and the freezer to -18°C to minimize the energy consumption. The fridge temperature setting displays “—” and the freezer compartment remains on.

- When the holiday function is on, you can switch off it by touching “Holiday” again, and the icon “” will be off. When the holiday function is on, the ice maker will automatically turn

off. The icon “” will still be illuminated after holiday function is off. The refrigerator will retain the setting when powered off.

Note:

- Do not store any food in the fridge during the “Holiday” time, or it will quickly deteriorate.
- The refrigerator temperature setting will revert back to the previous setting after the holiday function is off





Fridge

Super Cool 3^o

“Fridge temperature control”

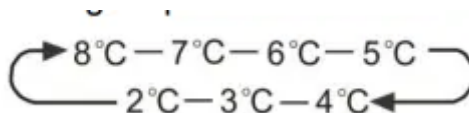
- You can touch the “Fridge” icon to activate the mode to control the fridge temperature. When you touch the button continuously, the temperature will be set in the following sequence



- If you want to decrease the time needed to cool products in the Fridge, please touch and hold this button for 3 seconds, the super cool icon “” will be illuminated, the fridge temperature setting displays 2°C. Super cool automatically switches off after 3 hours, and the refrigerator temperature setting will revert back to the previous setting.
- When super cool function is on, you can touch the “Fridge” to switch it off. The fridge will not retain the Super Cool function when power off.
- Note: On the Super Cool function, when you touch the “Holiday” or “Eco” button, “Holiday” or “Eco” function will be activated, and “Super Cool” mode will be off.





Freezer

Super Freeze 3^o

“Freezer temperature control”

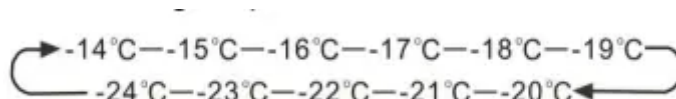

- You can touch the “Freezer” button to activate the mode to control the freezer temperature. When you press the button continuously, the temperature will be set in the following sequence.



- Press and hold the “Freezer” button for 3 seconds, the icon “” will be illuminated, the freezer temperature setting displays -24°C.
- Super Freezer can quickly lower the temperature and freeze your food faster than usual. This can retain more of the vitamins and nutrition in fresh food and keep your food longer.
- The super freeze option allows you to freeze the maximum amount of possible. We recommend that you let the appliance operate for 6 hours first. Super freeze automatically switches off after 26 hours, and the freezer temperature setting will revert back to the previous setting.

- When the super freeze function is on, you can touch “Freezer” for to switch off the Super Freeze function. And it will not retain the Super Freeze function when power off.
- Note: On the Super Freezer Function, when you touch the “Holiday” or “Eco” button, “Holiday” or “Eco” function will be activated, and “Super Freezer” mode will be off.

“Dispenser control”

- When the Child Lock is on, the dispenser will not work.
- The Icy Type button includes “Cubed” and “Crushed” options.
- You can press the "Cubed" or "Crushed" option to choose the type of Ice to be dispensed. You can touch the "Water" button to activate the water mode.
- When you touch the Ice Type button, the cubed or crushed ice mode which you choose will be activated, and the Cubed “”or Crushed“”ice icon lights up. If you don’t need ice, turn the function off to save on water and energy consumption. (See Ice Off above.)
- If you need water, please touch the “Water” button, and the water icon“”will light up. The mode is then set.





“Water Filter”

- In general, you should change the water filter every 6 months to ensure the highest possible water quality.
- After the refrigerator has dispensed about 1000 gallons of water(used the water filter for about 6 months), the filter icon “” will blink, and the buzzer will sound 3 times, that remind you need to replace the water filter.
- First of all, you need to purchase a new water filer. You can purchase the new filter from the retailer where you purchased your refrigerator or the after-sales service system. Before that please check that the new filter is the same filter type as before that can be correctly used in your refrigerator.
- After you change a new water filter, ensure to touch and hold the button “Eco” for 3 seconds to reset the filter. When you replace the water filter, some water may leak from the filter and lines. Please let the water flow in a pan, and wipe up any leakage that may have occurred.



“Energy Save”

- You can touch this button to turn Energy Saver mode on and off. When you turn Energy Saver on, the Energy Saver icon “”lights.
- The temperature of the fridge is automatically switched to 6°C and the freezer to -17°C.If Energy Saver is off , the icon “”will go off and the temperature setting will revert back to the previous setting.

Note:

- The control panel will light up when the door is open or you touch any button.
- The light will go off without touching any button or the doors have been closed over one minute.
- When the refrigerator is powered on, all the icons of the control panel will light up for 3 seconds, and a buzzer sounds. The Child Lock is off. And the temperature setting reverts back to the previous setting.

Using the control panel on My Fresh Choice door

The control panel on the fridge door shows in the diagram below.



When the appliance is powered on for first time, the backlighting of the the display panel starts

Temperature Selection Button

- Press the button “Temp.” repeatedly until your desired temperature is lit.
- When you touch the button “Temp.” continuously, the temperature will be set in the following sequence.

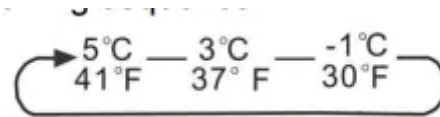

- If you want to select the temperature of -15°C /5°F, please touch and hold the button “Temp.” for 3 seconds until the icon “❄️” lights.
- To unlock the temperature of -15°C /5°F, please press and hold “❄️” “Temp.” for 3 seconds again until the icon “ ” goes out. Then the temperature will be reset to you set before.

Note:

- The light will go off without touching any button and the doors have been closed for 10 seconds.
- It will take about 4 hours before the temperature reach to the desired one after you have changed the you should take the food in My Fresh
- Choice room out before you place them in as required.
- Examples of food items can be stored in the My Fresh Choice by temperature setting.

5°C 41°F	3°C 37°F	-1°C 30°F	-15°C 5°F
·wine	·pineapples	·steaks	·frozen meat
·cocktails	·lemons	·cold cuts	·ice cream
·cakes	·biscuits	·bacon	·pizza
·cheeses	·potatoes	·chili dogs	

Using your appliance

This section tells you how to use most of the useful features. We recommend that you read through them carefully before using the appliance

1. Fixing the handle

- Before you use the appliance, please check the handle. If the handle is loose, you should fix it with an Allen wrench in the clockwise direction until handles are securely in place, and in the counter-clockwise to loose the handles. Eight screws are used to fix the handles, four in the refrigerator door, two in the flex door and the others in the freezer door



- Note: The eight screws, which are used to fix the handles, should be fixed in the right position. The two in the fridge left door should be fixed on the right side of the handle. The two in the fridge right door should be fixed on the left side of the handle. The four in the variation and freezer door should be fixed on the downside of the handles.

2. Getting cold water and ice

- Push the appropriate ice or water type button to select what you want dispensed.

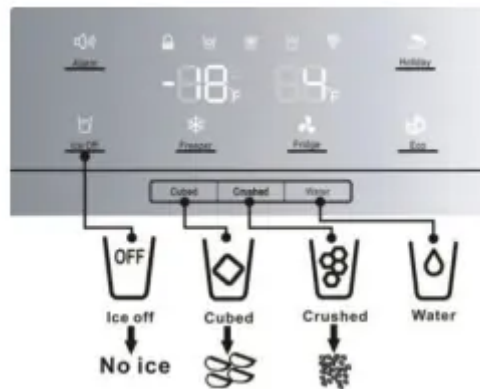

- Getting cold water: The water dispenser is located in the fridge door. To get water, push the water button. Then move your glass down the dispenser lever (A) in the suggested position and press it.

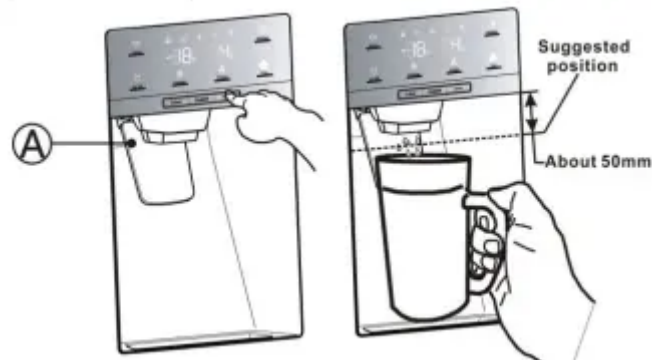

- Getting ice: To get ice, push the cubed or crushed ice button as required. Then move your glass down the dispenser lever in the suggested position and press it.

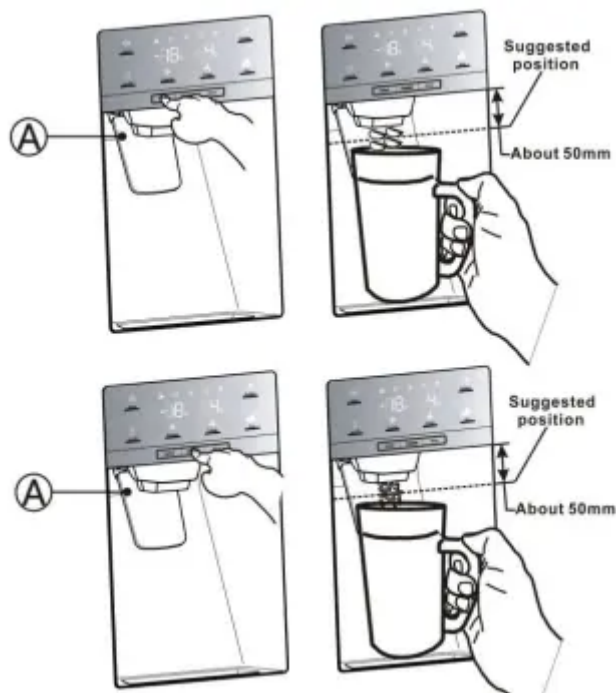

Maintaining the ice bucket

- To clean the ice bin/bucket, wash with a mild detergent, rinse well, and dry thoroughly it. Do not use harsh or abrasive cleaners or solvents.
- Ice is made in cubes. When you select 'Crushed', the ice maker grinds the ice cubes into crushed ice.
- When you select Cubed ice, a small amount of crushed ice might be produced.
- When you select Crushed ice, a small amount of cube ice might be produced.
- The ice cubes generated by the rapid ice making process will look white, which indicates they were generated normally.
- If ice doesn't come out, pull out the ice bucket and press the test button located on the right side of ice maker. To test the ice maker, stay pressing the test button on the ice maker for 10 seconds before released it. See the illustration blow.

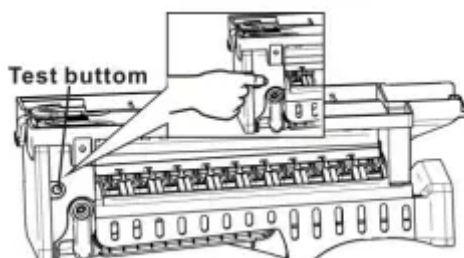

- Do not press the test button continuously when the tray is filled with ice or water. Water may overflow or ice may jam the bucket.

Making ice

- To fill the ice bucket to maximum capacity after installation, follow these steps:
 1. Allow your refrigerator to operate and cool down for 24 hours (or 1 full day). Waiting 24 hours will allow your ice maker to cool properly.
 2. Dispense 4 to 6 ice cubes into the glass.
 3. After 8, and then 16 hours, dispense a full glass of ice.

Using the ice off function

- When you select the ice off mode, remove all ice cubes from the bucket.
- If you leave the ice cubes in the bucket, the ice cubes may clump together, making it difficult to remove them.
- To remove the ice bucket safely and avoid injury, hold the bottom of the bucket with one hand and the side of the bucket with the other.
- Then, lift up on the ice bucket, and pull it straight out in the direction of the arrow
- To put the ice bucket in, push it firmly straight back. If the bucket does not turn the helix 90 degree (see the last illustration on the right, below) and again.

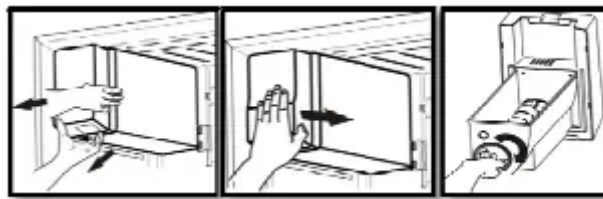

Going on vacation: If you have a long vacation or business trip and won't use the water or ice dispensers for a long time:

1. Close the water valve. Otherwise, water leakage may occur.
2. Remove all food.
3. Unplug the refrigerator.
4. Wipe excess moisture from inside and leave the doors open. Otherwise, odor and mold may develop.

Water clouding phenomenon

- All water provided to the refrigerator flows through the filter which is an alkaline water filter. In the filtering process, the pressure of the water that has flowed out of the filter is increased, and the water becomes saturated with oxygen and nitrogen. When this water flows out into the air, the pressure plummets and the oxygen and nitrogen get supersaturated, which results in gas bubbles. The water may temporarily look misty or cloudy due to these oxygen bubbles. After a few seconds, the water will look clear.

Cleaning

- After using for a period, water accumulated in receiving tank might overflow, thus you should clean it with dry towel regularly to avoid water spilling out onto the floor.



- Note: In case of stained by dust or other pollutant, dispensing water with unpleasant smell, etc., water dispenser parts should be cleaned thoroughly.

3. Changing the water filter

- To drink the freshest and cleanest water from your refrigerator, change the filter on time.
- To change the water filter, follow these steps:

1. Shut off the water supply. Then turn out the water filter (A) about 1/4 turn, counter-clockwise.

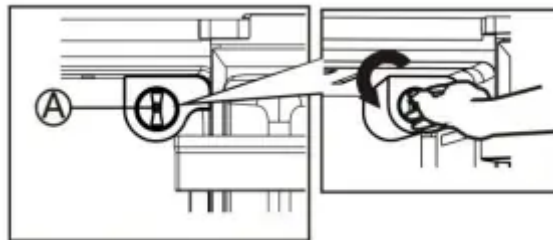

2. Pull the water filter (A) from the filter holder (B).

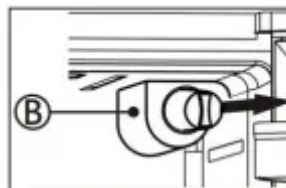

Note:

- To change the water filter more easily, shut off the water supply valve.
- Sometimes, it is hard to disassemble the water filter because impurities in the water cause it to stick. If you are having difficulties, grip the water filter firmly and pull it out.
- When you pull the water filter, a little water can leak from the opening. This is normal. To minimize the water leaks, keep the filter cartridge horizontal when pull it.
- To prevent overflow, empty the water filter tray (C) and dry around the filter case.

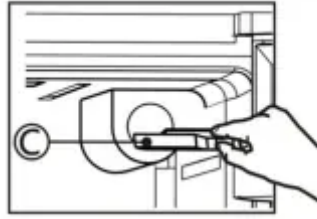

- You should re-install the water filter tray before inserting the new filter

3. Insert the new filter into the filter holder.

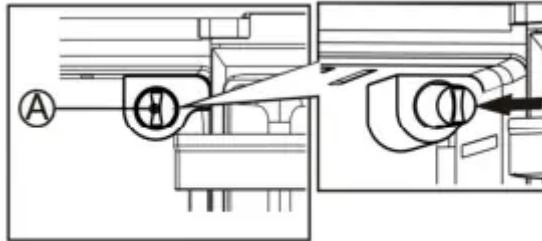

4. Push the filter, and then turn it clockwise until it locks.

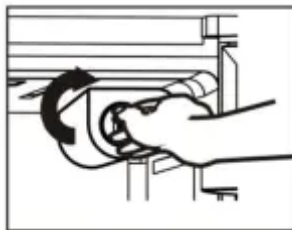

- If you have trouble inserting the water filter because of high water pressure, shut off the water supply valve.

5. If you turned off the water supply, turn it back on.

Removing any residual matter inside the water supply line after installing the water filter

1. Turn on the main water supply and supply water from water supply line.
2. Run water through the dispenser until the water runs clear (approx.6 to 7 minutes).This will clean the water supply system and remove the air from the lines.
3. Additional flushing may be required in some households.
4. Open the refrigerator door and make sure there are no water leaks coming from the water filter.

4. Using your fridge compartment

- The refrigerator compartment is suitable for storage of vegetables and fruit. Food inside should be packed to store in order to avoid losing moisture or flavor permeating into other foods.

- Caution! Never close the refrigerator door while the shelves, crisper and/or telescopic slides are extended. It may damage both them and the refrigerator.

Door baskets

- The refrigerator compartment is provided with several different door baskets, which are suitable for the storage of canned liquid, bottled drink and packed food.
- To remove the door baskets (A), simply lift the racks up and pull straight out.
- To relocate the door baskets (A), slide it in above the desired location and push down until it stops.

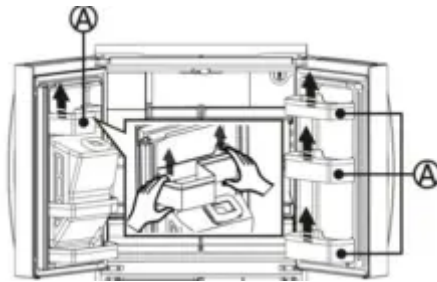

- To remove the door baskets (B), take the right side of the baskets out by lifting it at an angle along the guide, and then take the left side out by pulling it from the door. To relocate the door baskets (B), slide it into the original location and push down until it sticks.



Glass shelves

- To remove the glass shelves, tilt the front of the shelf in the direction shown (1) and lift it up vertically (2). Pull the shelf out.



- To re-install the glass shelves, tilt the front of the shelf up and guide the shelf hooks into the slots at a desired height (1). Then lower the front of the shelf so that the hooks can drop into the slots (2).

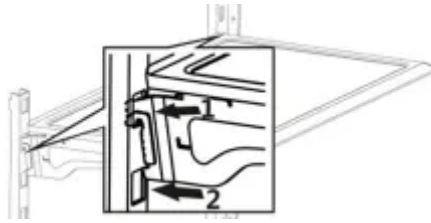

- The refrigerator compartment is also provided with a foldable shelf. It can be folded as required.
- To fold the shelf, hold the removable glass(C) and lift it up slightly, then push it slightly in the direction of the arrow.



- To unfold the shelf, hold the removable glass(C) and pull it out slightly in the direction of the arrow until it can't move



Wine rack

- The refrigerator compartment provides a plastic wine rack, which could be used for placing 2 bottles of wine or 12 eggs.

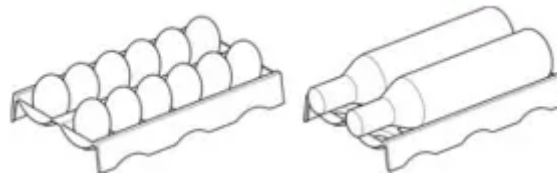

Vegetable and fruit crispers

- The crispers (D) are suitable for storage of vegetable and fruit. To take them out, remove the two baskets first.

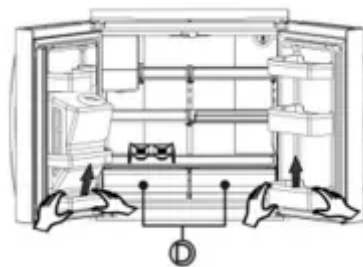

- Then pull out the draw and tilt up the front of the crisper after moving slightly in the directing of the arrow.

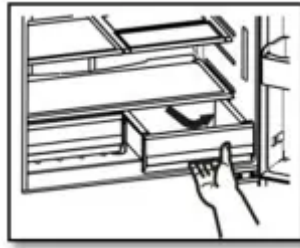

Using My Fresh Choice compartment

- The My Fresh Choice compartment is provided with two panels (F). Change the fixed position of the panel as required. To change the fixed position, hold the panel in the wanted position.

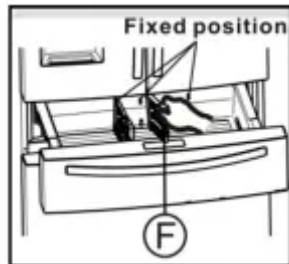

- When My Fresh Choice or LED lighting does not work, check the two connectors (G, H) for crack or looseness.

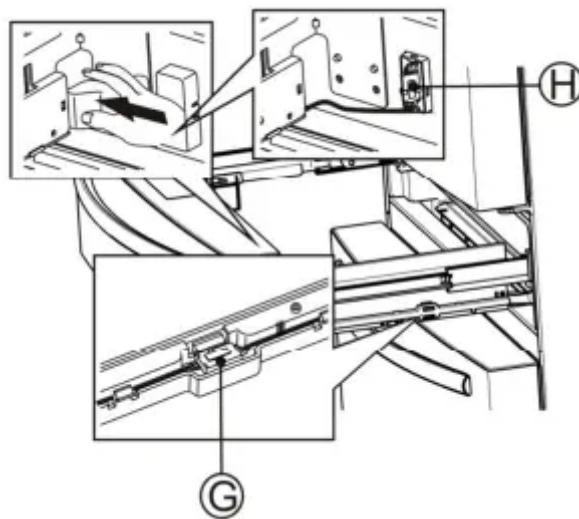

- To remove My Fresh Choice, refer to page 7 for disassembly instruction.

Using the freezer compartment

- The freezer compartment is provided with an upper drawer, a lower drawer and a rack. To remove all of them, refer to page 8 for disassembly instruction.

Lower drawer

- To remove the lower drawer, pull out the freezer door, lift up and push the upper drawer slightly with one hand. Then remove the lower drawer with your both hands

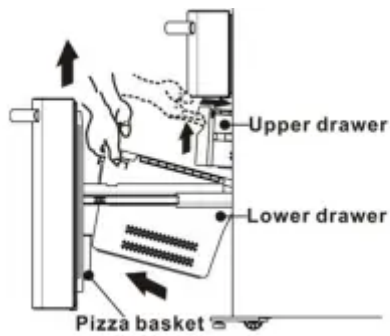

Pizza basket

- The basket on the freezer door is for pizzas. Pizzas inside should be packed. To place pizzas to the basket, put them into the basket in the directing of the arrow.



Cleaning and care

- For hygienic reasons the appliance (including exterior and interior accessories) should be cleaned regularly at least every two months.
- Warning! The appliance must not be connected to the mains during cleaning. Danger of electrical shock! Before cleaning switch the appliance off and remove the plug from the mains socket

Exterior cleaning

To maintain good appearance of your appliance, you should clean it regularly.

- Spray water onto the cleaning cloth instead of spraying directly on the surface of the appliance. This helps ensure an even distribution of moisture to the surface.
- Clean the doors, handles and cabinet surfaces with a mild detergent and then wiped dry with a soft cloth.

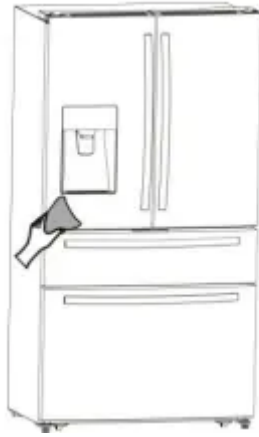

Caution!

- Don't use sharp objects as they are likely to scratch the surface.
- Don't use Thinner, Car detergent, Clorox, ethereal oil, abrasive cleansers or organic solvent such as Benzene for cleaning. They may damage the surface of the appliance and may cause fire

Interior cleaning

- You should clean the appliance interior regularly. It will be easier to clean when food stocks are low. Wipe the inside of the fridge freezer with a weak solution of bicarbonate of soda, and then rinse with warm water using a wrung-out sponge or cloth. Wipe completely dry before replacing the shelves and baskets. Thoroughly dry all surfaces and removable parts before putting them back into place.

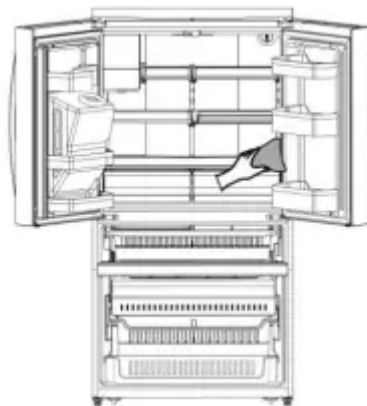

- Although this appliance automatically defrosts, a layer of frost may occur on the freezer compartment's interior walls if the freezer door is opened frequently or kept open too long. If the frost is too thick, choose a time when the freezer is nearly empty and proceed as follow:
 1. Remove existing food and accessories baskets, unplug the appliance from the mains power and leave the doors open. Ventilate the room thoroughly to accelerate the process.

2. When defrosting is completed, clean your freezer as described above.

Warning! Do not use sharp objects to remove frost from the freezer compartment. Only after the interior is completely dry should the appliance be switched back on and plugged back into the mains socket.

Door seals cleaning

- Take care to keep door seals clean. Sticky food and drinks can cause seals to stick to the cabinet and tear when you open the door. Wash seal with a mild detergent and warm water. Rinse and dry it thoroughly after cleaning.



- Caution! Only after the door seals are completely dry should the appliance be powered on

Replacing the LED light

Warning: The LED light must be replaced by a competent person. If the LED light is damaged, follow the steps below:

1. Unplug your appliance.
2. Remove light cover by rising up and pulling out the LED light.
3. Hold the LED light with one hand and pull it with the other hand while pressing the connector latch.
4. Replace LED light and snap it correctly in place and recover the light cover.

Helpful hints and tips

Energy saving tips

We recommend that you follow the tips below to save energy.

- Try to avoid keeping the door open for long periods in order to conserve energy. Ensure the appliance is away from any sources of heat (Direct sunlight, electric oven or cooker etc) Don't set the temperature colder than necessary.

- Don't store warm food or evaporating liquid in the appliance.
- Place the appliance in a well ventilated, humidity free, room. Please refer to Installing your new appliance chapter.
- If the diagram shows the correct combination for the drawers, crisper and shelves, do not adjust the combination as this is designed to be the most energy efficient configuration.

Hints for fresh food refrigeration

- Do not place hot food directly into the refrigerator or freezer, the internal temperature will increase resulting in the compressor having to work harder and will consume more energy.
- Do cover or wrap the food, particularly if it has a strong flavor.
- Place food properly so that air can circulate freely around it.

Hints for refrigeration

- Meat (All Types) Wrap in polythene food: wrap and place on the glass shelf above the vegetable drawer. Always follow food storage times and use by dates suggested by manufacturers.
- Cooked food, cold dishes, etc.: They should be covered and may be placed on any shelf.
- Fruit and vegetables: They should be stored in the special drawer provided.
- Butter and cheese: Should be wrapped in airtight foil or plastic film wrap.
- Milk bottles: Should have a lid and be stored in the door racks.

Hints for freezing

- When first starting-up or after a period out of use, let the appliance run at least 2 hours on the higher settings before putting food in the compartment.
- Prepare food in small portions to enable it to be rapidly and completely frozen and to make it possible to subsequently thaw only the quantity required.
- Wrap up the food in aluminum foil or polyethylene food wraps which are airtight,
- Do not allow fresh, unfrozen food to touch the food which is already frozen to avoid temperature rise of the latter.
- Iced products, if consumed immediately after removal from the freezer compartment, will probably cause frost burns to the skin.
- It is recommended to label and date each frozen package in order to keep track of the storage time.

Hints for the storage of frozen food

- Ensure that frozen food has been stored correctly by the food retailer

- Once defrosted, food will deteriorate rapidly and should not be re-frozen. Do not exceed the storage period indicated by the food manufacturer.

Switching off your appliance

If the appliance needs to be switched off for an extended period, the following steps should be taken prevent mould on the appliance.

1. Remove all food.
2. Remove the power plug from the mains socket.
3. Clean and dry the interior thoroughly.
4. Ensure that all the doors are wedged open slightly to allow air to circulate.

Troubleshooting

If you experience a problem with your appliance or are concerned that the appliance is not functioning correctly, you can carry out some easy checks before calling for service, please see below.

Warning! Don't try to repair the appliance yourself. If the problem persists after you have made the checks mentioned below, contact a qualified electrician, authorized service engineer or the shop where you purchased the product.

Problem	Possible cause & Solution
Appliance is not working correctly	<p>Check whether the power cord is plugged into the power outlet properly.</p> <p>Check the fuse or circuit of your power supply, replace if necessary.</p> <p>The ambient temperature is too low. Try setting the chamber temperature to a colder level to solve this problem.</p> <p>It is normal that the freezer is not operating during the defrost cycle, or for a short time after the appliance is switched on to protect the compressor.</p>
Odours from the compartments	<p>The interior may need to be cleaned</p> <p>Some food, containers or wrapping cause odours.</p>
Noise from the appliance	<p>The sounds below are quite normal:</p> <ul style="list-style-type: none"> • Compressor running noises. • Air movement noise from the small fan motor in the freezer compartment or other compartments. • Gurgling sound similar to water boiling. • Popping noise during automatic defrosting. • Clicking noise before the compressor starts. • Clicking noise when you get the water. • The motor running noises when you get the ice. <p>Other unusual noises are due to the reasons below and may need you to check and take action: The cabinet is not level. The back of appliance touches the wall. Bottles or containers fallen or rolling.</p>
The motor runs continuously	<p>It is normal to frequently hear the sound of the motor, it will need to run more when in following circumstances:</p> <ul style="list-style-type: none"> • Temperature setting is set colder than necessary • Large quantity of warm food has recently been stored within the appliance. • The temperature outside the appliance is too high. • Doors are kept open too long or too often. • After your installing the appliance or it has been switched off for a long time.

<p>A layer of frost occurs in the compartment</p>	<p>Check that the air outlets are not blocked by food and ensure food is placed within the appliance to allow sufficient ventilation. Ensure that door is fully closed. To remove the frost, please refer to the“Cleaning and care” chapter.</p>
<p>Temperature inside is too warm</p>	<p>You may have left the doors open too long or too frequently; or the doors are kept open by some obstacle; or the appliance is located with insufficient clearance at the sides, back and top</p>
<p>Temperature inside is too cold</p>	<p>too cold Increase the temperature by following the “Display controls” chapter.</p>
<p>Doors can't be closed easily</p>	<p>Check whether the top of the refrigerator is tilted back by 10-15mm to allow the doors to self close, or if something inside is preventing the doors from closing.</p>
<p>The light is not working</p>	<p>The LED light may be damaged. Refer to replace LED lights in cleaning and care chapter.</p> <p>The control systems has disabled the lights due to the door being kept open too long, close and reopen the door to reactivate the lights.</p>
<p>Ice is not dispensing</p>	<p>Did you wait for 12 hours after installation of the water supply line before making ice? If it is not sufficiently cool, it may take longer to make ice, such as when first installed.</p> <p>Is the water line connected and the water valve open?</p> <p>Did you manually stop the ice making function? Make sure you do not set the ice off mode.</p> <p>Is there any ice blocked within the ice maker bucket or ice chute?</p> <p>Is the water pressure less than 207kPa? Install a booster pump to compensate for the low pressure.</p> <p>Is the freezer temperature too warm? Try setting the freezer temperature lower.</p> <p>Whether the quantity supplied is larger than the quantity supplied? Please wait for at least 90 minutes.</p>
<p>Water dispenser is not functioning</p>	<p>Is the water line connected and the water valve open?</p> <p>Has the water line been crushed or kinked? Make sure the water line is free and clear of any obstruction.</p>



	<p>Is the water tank frozen because the refrigerator temperature is too low? Try selecting a warmer setting on the display panel.</p> <p>Check if the filter is properly installed. If it is not properly installed, the water dispenser may not work.</p> <p>Is the Child Lock on?</p>
Hear water bubbling in the refrigerator	This is normal. The bubbling comes from the refrigerant coolant liquid circulating through the refrigerator

Warning

This content is compiled from multiple sources and is provided for reference purposes only. It may not be complete or fully applicable to all situations. If you are unable to resolve your issue, please contact the product manufacturer or an authorized service provider for official support.

