

Aluminized alloy drum Gas Dryer User Manual

Operating instructions

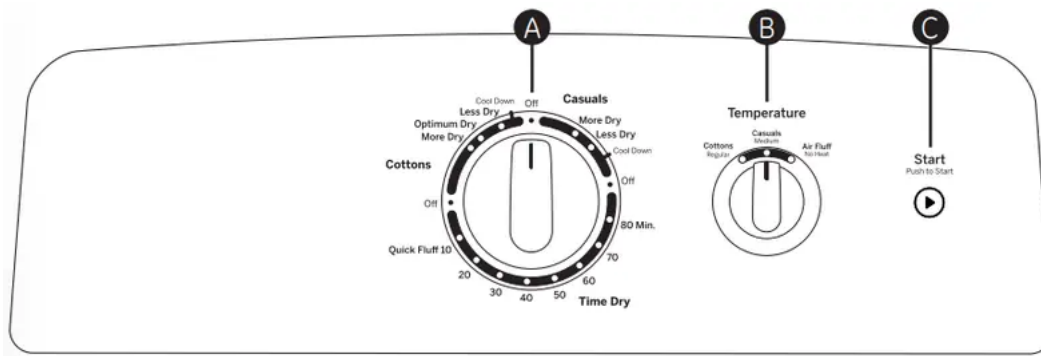

IMPORTANT: Clean the lint filter each time you use the dryer.

A - Drying Cycles (Not all features are on all models)

- **Cottons** For cottons and most linens. For most loads, select Optimum Dry (on some models).
- **Casuals** For wrinkle-free, permanent press and delicate items, and knits.
- **Delicates** On some models. For delicate items, special-care fabrics and knits.
- **Time Dry** Set the Cycle Selector at the desired drying time.
- **Quick Fluff** For freshening or fluffing up already dry clothing, fabrics, linens and pillows. Use with Air Fluff No Heat. Provides 10 minutes of no heat tumbling.
 - *Sensor cycles automatically determine fabric dryness. Select Less Dry if you want your clothes slightly damp at the end of the drying cycle. Select More Dry if you want them to feel drier.*
 - *Timed cycles run for a selected time.*

B - Temperature (Not all features are on all models)

- **Cottons Regular** For regular to heavy cottons.
- **Casuals Medium** For synthetics, blends, delicates and items labeled permanent press.
- **Delicates Low** On some models. For delicates, synthetics and items labeled tumble dry low.
- **Air Fluff No Heat** On some models. For fluffing items without heat. Use the Time Dry cycle.

C - Start-Close the dryer door. Press **Start**. Opening the door during operation will stop the dryer. To restart the dryer, close the door and select **Start** to complete the cycle.

- NOTE: Drying times will vary according to the type of heat used (Electric, Natural or LP gas), size of load, types of fabrics, wetness of clothes and condition of exhaust ducts.

Sorting and Loading Hints

As a general rule, if clothes are sorted properly for the washer, they are sorted properly for the dryer.

- Do not add fabric softener sheets once the load has become warm. They may cause fabric softener stains. Bounce® Fabric Conditioner Dryer Sheets have been approved for use in all GE Dryers when used in accordance with the manufacturer's instructions.
- **Do not overload.** This wastes energy and causes wrinkling.
- **Do not dry the following items:** fiberglass items, woolens, rubber-coated items, plastics, items with plastic trim and foam-filled items.

Fabric Care Labels

WASH LABELS

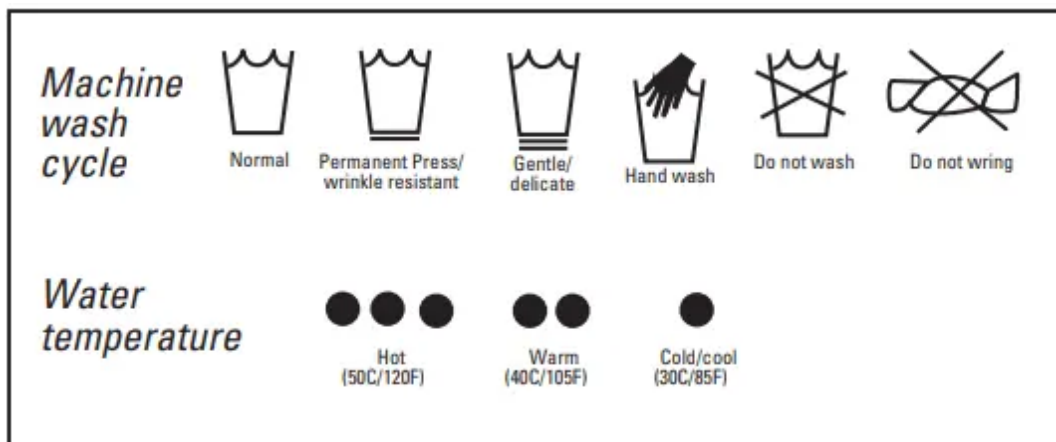

DRY LABELS

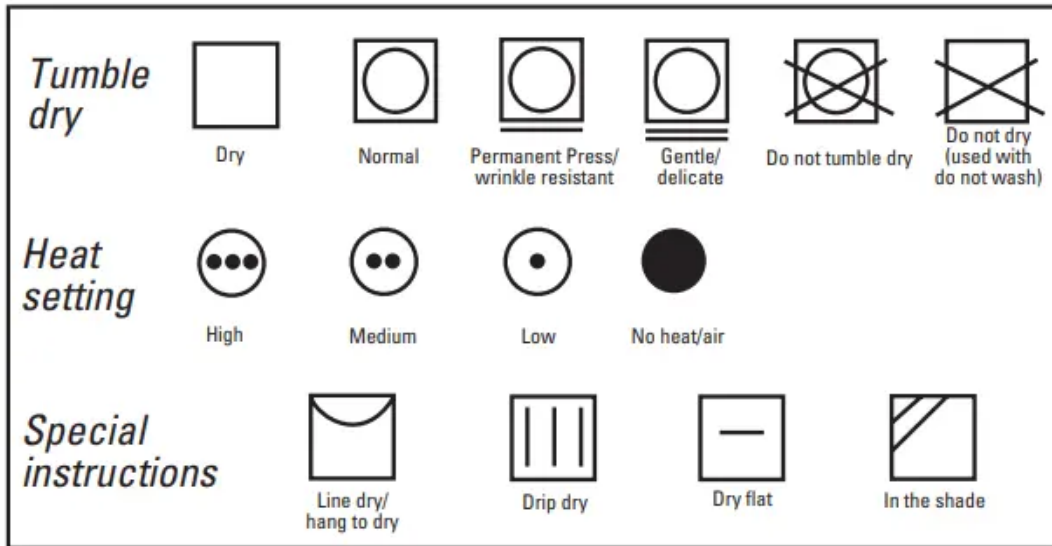

BLEACH LABELS

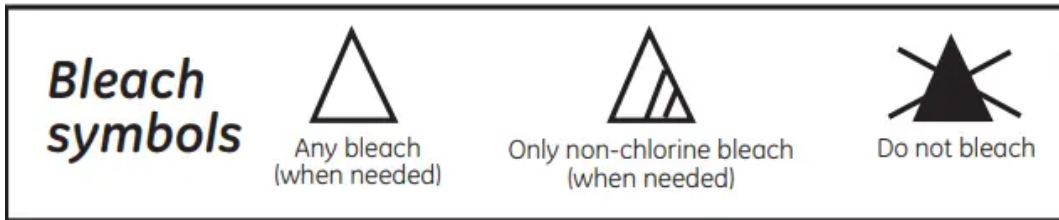

Dryer features

Drum Lamp (on some models)

Before replacing the light bulb, be sure to unplug the dryer power cord or disconnect the dryer at the household distribution panel by removing the fuse or switching off the circuit breaker.

Reach above dryer opening from inside the drum. Remove the bulb and replace with the same size bulb.



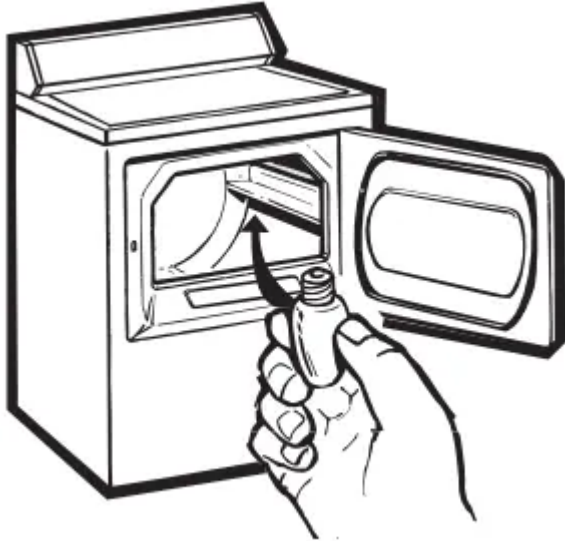

Drying Rack (on some models)

A handy drying rack may be used for drying delicate items such as washable sweaters. Hook the rack over the lint filter so the rack extends into the dryer drum.

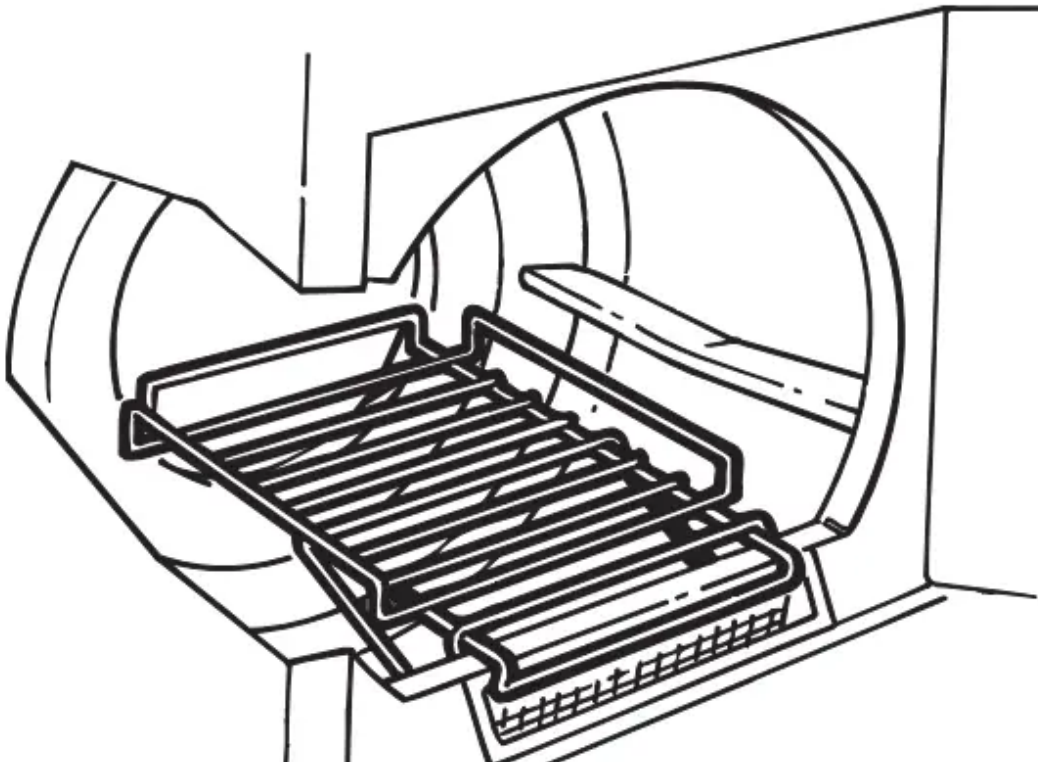

NOTE:

- The drying rack must be used with the Time Dry cycle.
- Do not use this drying rack when there are other clothes in the dryer. If your model did not come with a drying rack, order one on-line at GEApplianceparts.com.

Alloy Steel Drum (on some models)

The alloy steel used to make the dryer drum provides the highest reliability available in a GE dryer.

If the dryer drum should be scratched or dented during normal use, the drum will not rust or corrode. These surface blemishes will not affect the function or durability of the drum.

Care and Cleaning

The Exterior: Wipe or dust any spills or washing compounds with a damp cloth. Dryer control panel and finishes may be damaged by some laundry pretreatment soil and stain remover products. Apply these products away from the dryer. The fabric may then be washed and dried normally. Damage to your dryer caused by these products is not covered by your warranty.

The Lint Filter: Clean the lint filter before each use.

Remove by pulling straight up. Run your fingers across the filter. A waxy buildup may form on the lint filter from using dryer added fabric softener sheets.

To remove this buildup, wash the lint screen in warm, soapy water. Dry thoroughly and replace. Do not operate the dryer without the lint filter in place.

Vacuum the lint from the dryer lint filter area if you notice a change in dryer performance.

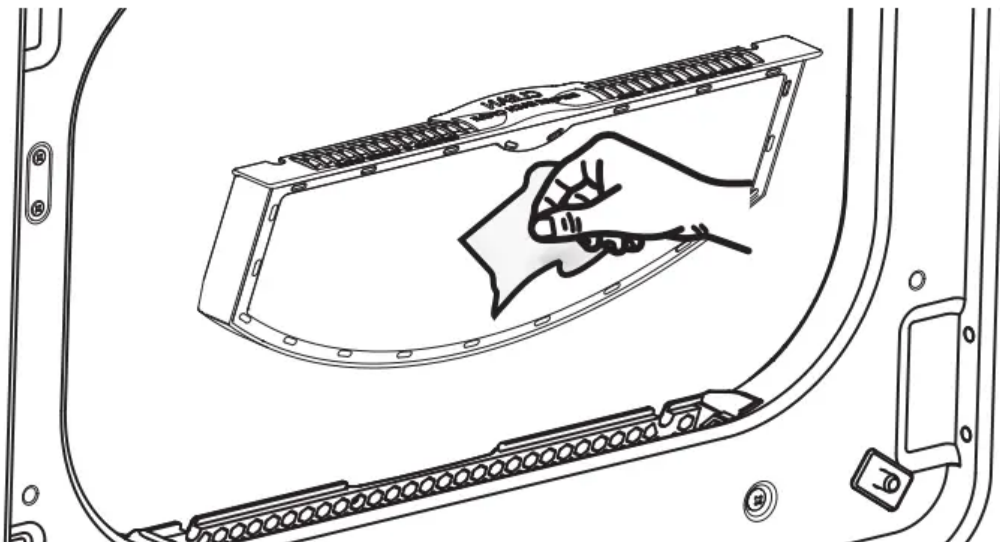

Stainless Steel: To clean stainless steel surfaces, use a damp cloth with a mild, non-abrasive cleaner suitable for stainless steel surfaces. Remove the cleaner residue, and then dry with a clean cloth.

Dryer Interior and Duct: The interior of the appliance and exhaust duct should be cleaned once a year by qualified service personnel.

The Exhaust Duct: Inspect and clean the exhaust ducting at least once a year to prevent clogging. A partially clogged exhaust can lengthen the drying time.



Follow these steps:

1. Turn off electrical supply by disconnecting the plug from the wall socket.
2. Disconnect the duct from the dryer.
3. Vacuum the duct with the hose attachment and reconnect the duct.

The Exhaust Hood: Check with a mirror that the inside flaps of the hood move freely when operating. Make sure that there is no wildlife (birds, insects, etc.) nesting inside the duct or hood.

Venting the Dryer

For the best drying performance, the dryer needs to be properly vented. The dryer will use more energy and run longer if it is not vented to the specifications below. Carefully follow the details on Exhausting in the Installation Instructions.

	
Correct Venting	Incorrect Venting

WARNING - Fire Hazard

This dryer **MUST** be exhausted to the outdoors.

- Use only 4” rigid metal ducting for the home exhaust duct.
- Use only 4” rigid metal or UL-listed dryer transition duct to connect the dryer to the home exhaust.
- DO NOT use a plastic vent.
- DO NOT exhaust into a chimney, kitchen exhaust, gas vent, wall, ceiling, attic, crawl space, or concealed space of a building.
- DO NOT install a screen in or over the exhaust duct.
- DO NOT install a booster fan in the exhaust duct.
- DO NOT use duct longer than specified in the exhaust length table.

Failure to follow these instructions can result in death or fire.

Troubleshooting

Dryer doesn’t start

- Dryer is unplugged
 - Make sure the dryer plug is pushed completely into the outlet.



- Fuse is blown/circuit breaker is tripped
 - Check the house fuse/circuit breaker box and replace fuse or reset breaker.
Note: Most electric dryers use 2 fuses/breakers.

Dryer doesn't heat

- Fuse is blown/circuit breaker is tripped; the dryer may tumble but not heat
 - Check the house fuse/circuit breaker box and replace both fuses or reset both breakers. Your dryer may tumble if only one fuse is blown or one breaker tripped.
- Gas service is off
 - Make sure gas shutoff at dryer and main shutoff are fully open.

Dryer shakes or makes noise

- Some shaking/noise is normal. Dryer may be sitting unevenly
 - Move dryer to an even floor space, or adjust leveling legs as necessary until even.

Greasy spots on clothes

- Improper use of fabric softener
 - Follow directions on fabric softener package.
- Drying dirty items with clean ones
 - Use your dryer to dry only clean items. Dirty items can stain clean items and the dryer.
- Clothes were not completely clean
 - Sometimes stains which cannot be seen when the clothes are wet appear after drying. Use proper washing procedures before drying.

Lint on clothes

- Lint filter is full
 - Clean lint screen before each load.
- Improper sorting
 - Sort lint producers (like chenille) from lint collectors (like corduroy).

- Static electricity can attract lint
 - See suggestions in this section under static occurs.
- Overloading
 - Separate large loads into smaller ones.
- Paper, tissue, etc. left in pockets
 - Empty all pockets before laundering clothes.

Static occurs

- No fabric softener was used
 - Try a fabric softener.
 - Bounce® Fabric Conditioner Dryer Sheets have been approved for use in all GE Dryers when used in accordance with the manufacturer's instructions.
- Overdrying
 - Try a fabric softener.
 - Adjust setting to Less Dry.
- Synthetics, permanent press and blends can cause static
 - Try a fabric softener.

Inconsistent drying times

- Type of heat
 - Automatic drying times will vary according to the type of heat used (electric, natural or LP gas), size of load, types of fabrics, wetness of clothes and condition of exhaust ducts.

Clothes take too long to dry

- Improper sorting
 - Separate heavy items from lightweight items (generally, a well-sorted washer load is a well-sorted dryer load).
- Large loads of heavy fabrics (like beach towels)
 - Large, heavy fabrics contain more moisture and take longer to dry. Separate large, heavy fabrics into smaller loads to speed drying time.
- Controls improperly set
 - Match control settings to the load you are drying.

- Lint filter is full
 - Clean lint filter before every load.
- Improper or obstructed ducting
 - Check installation instructions for proper ducting/venting.
 - Make sure ducting is clean, free of kinks and unobstructed.
 - Check to see if outside wall damper operates easily.
 - Check the Installation Instructions to make sure the dryer venting is correct.
- Blown fuses or tripped circuit breaker
 - Replace fuses or reset circuit breakers. Since most dryers use 2 fuses/ breakers, make sure both are operating.
- Overloading/combining loads
 - Do not put more than one washer load in the dryer at a time.
- Underloading
 - If you are drying only one or two items, add a few items to ensure proper tumbling.

Clothes are wrinkled

- Overdrying
 - Select a shorter drying time.
 - Remove items while they still hold a slight amount of moisture. Select a Less Dry setting.
- Letting items sit in dryer after cycle ends
 - Remove items when cycle ends and fold or hang immediately.
- Overloading
 - Separate large loads into smaller ones.

Clothes shrink

- Some fabrics will naturally shrink when washed. Others can be safely washed, but will shrink in the dryer
 - To avoid shrinkage, follow garment care labels exactly.
 - Some items may be pressed back into shape after drying
 - If you are concerned about shrinkage in a particular item, do not machine wash or tumble dry it.

Warning

This content is compiled from multiple sources and is provided for reference purposes only. It may not be complete or fully applicable to all situations. If you are unable to resolve your issue, please contact the product manufacturer or an authorized service provider for official support.

Document generated by [ManualsFile](#)