

Getting started with your steam mop

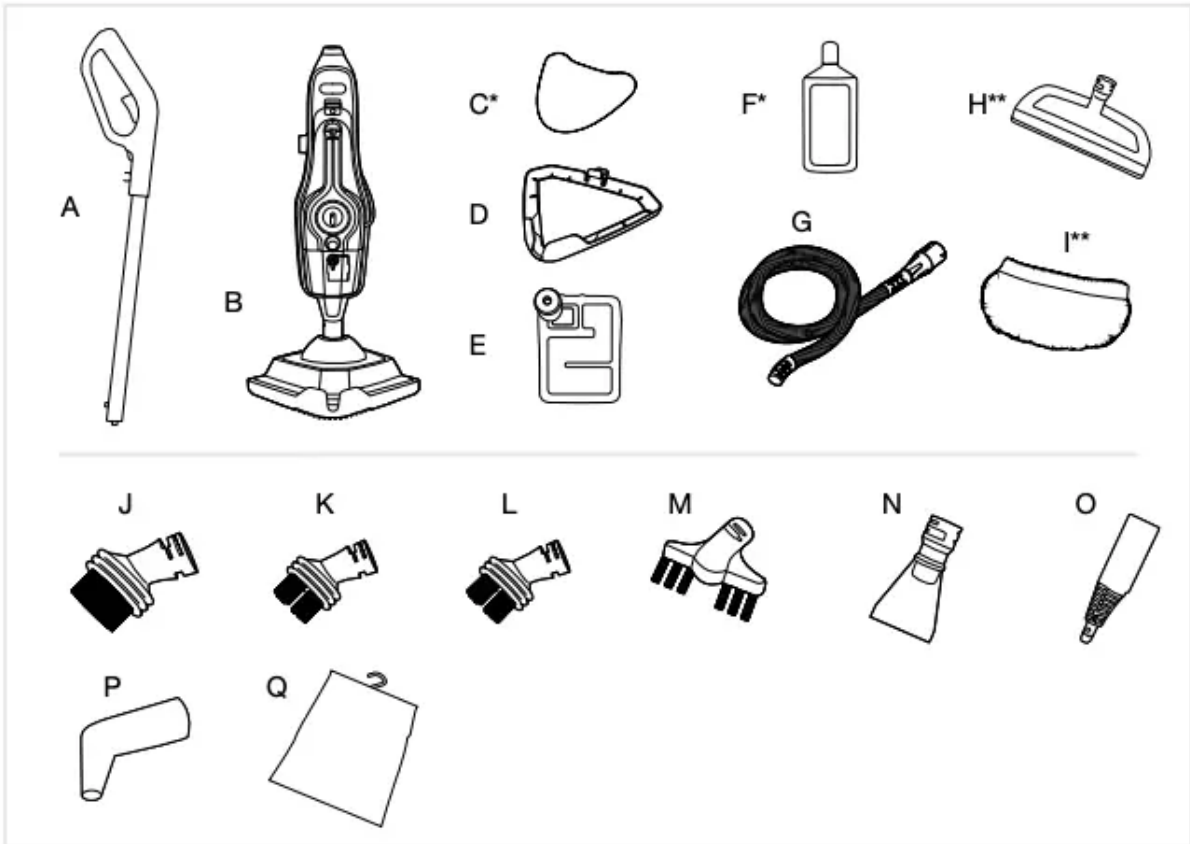

CARTON CONTENTS

- A. Handle
- B. Steam Mop Body (Water Tank and Solution Tank attached)
- C. Multi-Surface Microfiber Pads x2) *quantities vary per model
- D. Carpet Glider
- E. Water Filter (Pre-assembled in steam cleaner, remove water tank to expose filter)
- F. 8 oz. 4X Steam Multi-floor Cleaning Solution *quantities vary per model
- G. Hose
- H. Squeegee Tool**
- I. Upholstery Cloth Tool**
- J. Large Plastic Brush
- K. Small Plastic Brush

L. Metal Brush

M. Grout Brush

N. Scraper Nozzle

O. Concentration Nozzle

P. Detail Nozzle

Q. Accessory Bag

Remove all parts from carton and identify each item shown.

Make sure all parts are located before disposing of packing materials.

**Select models only

Assembly

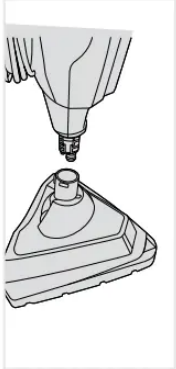
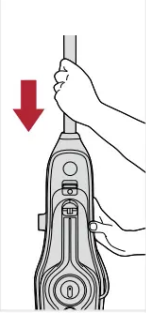
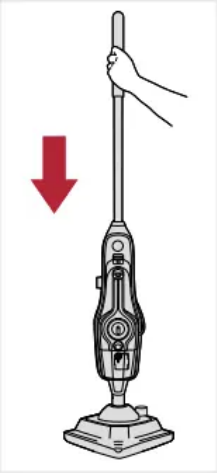
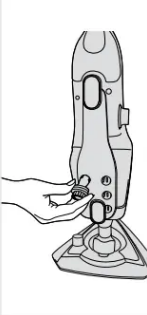
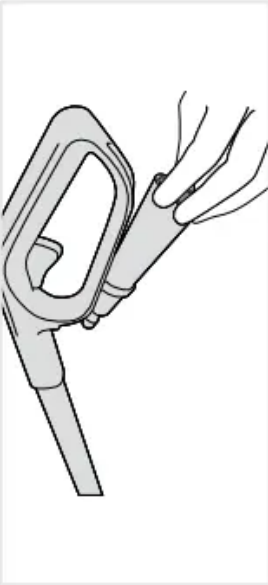
 <p>1 Insert the body into the floor head until it clicks into place.</p>	 <p>2 Insert the handle until it clicks into place.</p>	 <p>3 To stand steam mop upright, push handle down until clicks into place.</p>	 <p>4 Insert tools into the back of the steam mop.</p>	 <p>5 Insert concentration nozzle into the storage hook on the back of handle.</p>
---	---	---	---	--

Cord storage

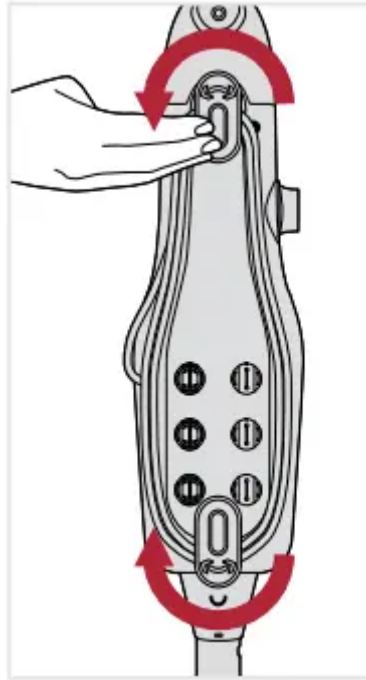

1. Wrap cord around cord release hooks.

WARNING To reduce the risk of personal injury - Unplug the steam cleaner when assembling the accessories.

IMPORTANT Never use the Steam Mop without the Microfiber Pad correctly attached to the Mop Head.

The “Multi-Surface Microfiber Pad” can be used on all sealed hard floor surfaces as well as carpet. When using on carpet the carpet glider attachment should be utilized as directed in the “Refreshing Carpet” section of this manual.

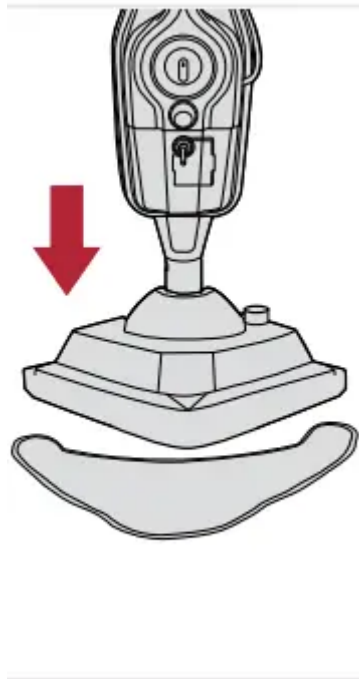

1. Place the cleaning pad on the floor white side facing up. Place steam mop on top of pad making sure the Mop Head covers the entire pad. Hook and loop feature on the bottom of the mop will hold the pad in place.

How to use

1. Handle
2. Solution Trigger (behind)
3. Handheld release button
4. Handheld Steam Trigger
5. Solution Control Dial
6. Steam Ready Indicator
7. Steam Control Dial
8. On/Off Switch
9. Water Tank
10. Hard Water Filter (hidden)
11. Tile & Grout Scrub Brush (hidden)
12. Floorhead
13. SteamStream™ on/off button
14. Concentration Nozzle Storage
15. Handle Release Button
16. Solution Tank
17. Quick Cord Release Hook
19. Floorhead Release Button
20. Carpet Glider

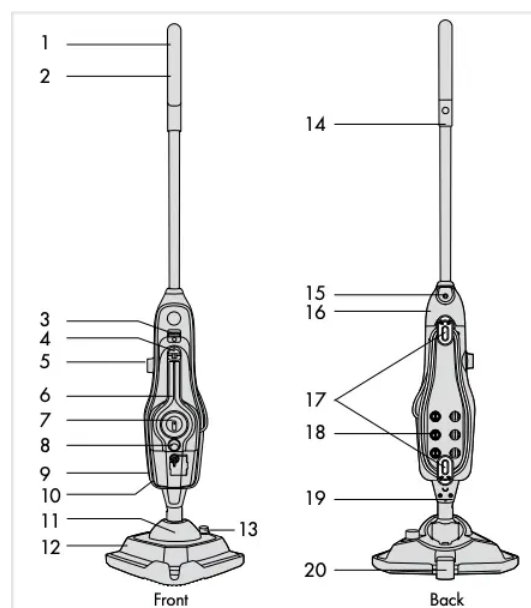

Before you begin cleaning

Filling the twin tanks

WARNING To avoid the risk of personal injury - Turn off, unplug, and allow steam cleaner to cool before servicing or filling water or solution tank. Do not use hot or boiling water to fill water tank.

• **IMPORTANT** • DO NOT MIX HOOVER® 4X STEAM MULTI-FLOOR CLEANING SOLUTION WITH ANY OTHER CLEANING SOLUTION.

• **IMPORTANT** • DO NOT ADD SOLUTION TO WATER TANK.

NOTE: When the tank is turned upright it may allow a few drops to drip from cap. This is normal.

• **IMPORTANT** • If you don't want to use solution on your flooring, turn solution dial to OFF position. Always test on an inconspicuous area of flooring first before using solution.

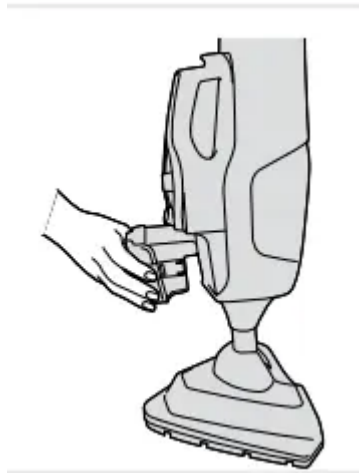

1 Press the water tank release buttons and pull the water tank to remove.

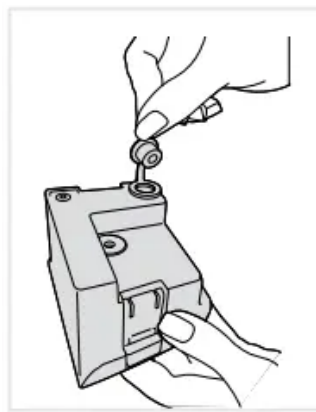

2 Pull the tab on the water tank cap to open.

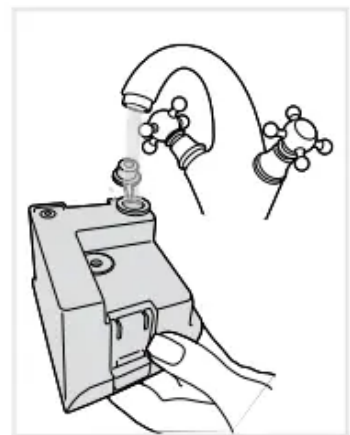

3 Fill the water tank with water only to fill line, replace the cap and push firmly to close.

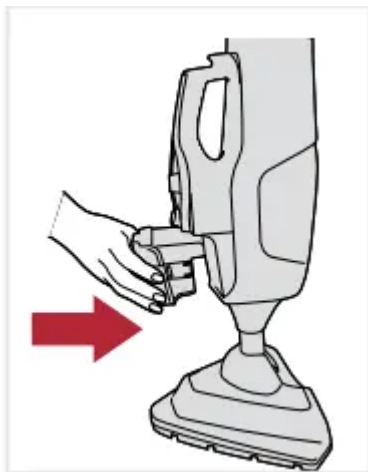

4 Slide the water tank back into the machine until it clicks into place.

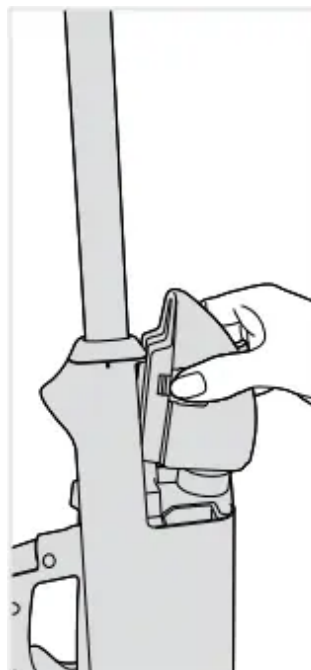

5 To remove the solution tank press both release buttons and pull to release.



6 Twist the solution tank cap counter clockwise and lift to remove.

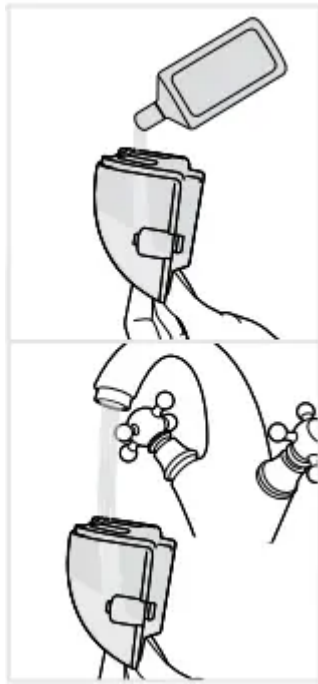

7 Pour solution to the solution fill line. Then fill remainder with water. See tank fill lines for reference.

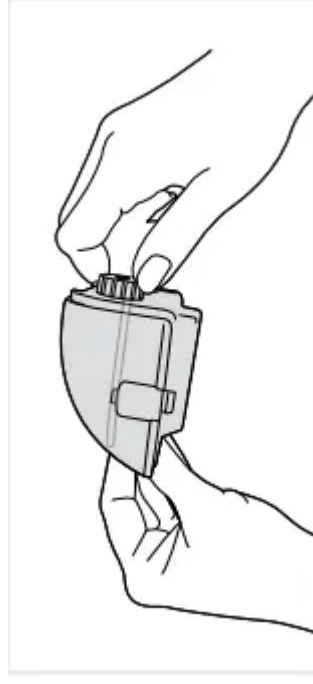

8 Replace the solution tank cap and twist clockwise to close.

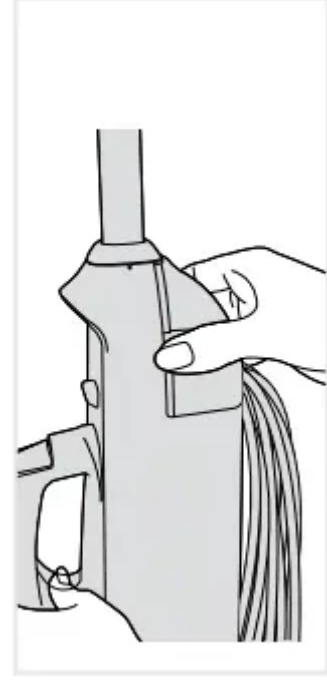

9 Insert the solution tank back into the machine until it clicks into place.

WARNING Only use recommended Hoover® 4x Steam Multi-Floor Cleaning Solution.

- The steam mop and accessories get very hot during use, always allow them to cool down before handling.
- Always unplug and switch off the steam mop when assembling.
- Always switch off the steam mop before emptying the water tank or changing the cleaning pads/accessories.
- **IMPORTANT:** Please refer to floor manufacturer's care recommendations before use and test the steam mop on a discrete area of flooring to begin with.
- When using the steam mop, basic safety precautions should always be observed.
- Don't aim the steam mop at people, animals, plants or electrical components such as interior of ovens or wires. Never touch the steam spray or floor head from a short distance. (There is a risk of scalding)
- The steam mop is equipped with a thermostat and a thermal cut out. If for any reason the steam mop overheats it will switch off. If this happens turn off and unplug the steam mop, allow to cool for a least 2 to 4 hours and re-start.

Using your machine

WARNING Never leave the Steam Mop in one spot on any surface for an extended period of time with a damp or wet Microfiber pad attached as this may damage the floor surface. When cleaning hard floors, your Steam Mop should only be used on tiles, linoleum, sealed hardwood flooring, engineered hardwood, laminate, vinyl and sealed stone floors. If used on waxed flooring, you may experience loss of glossiness. To reduce the risk of personal injury, unplug the steam cleaner when assembling the accessories. Do not clean over floor electrical outlets. Do not use steam cleaner or press the Steam Trigger without water in the water tank.

IMPORTANT Never use the Steam Mop without the Microfiber pad properly attached to the Mop Head.

WARNING To reduce the risk of personal injury - Unplug the steam cleaner when assembling the accessories.

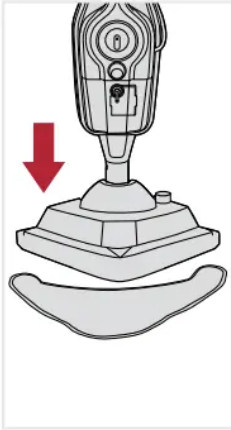

1 Place the microfiber pad on the floor white side facing up. Place steam mop onto pad making sure the entire pad covers the floor head.

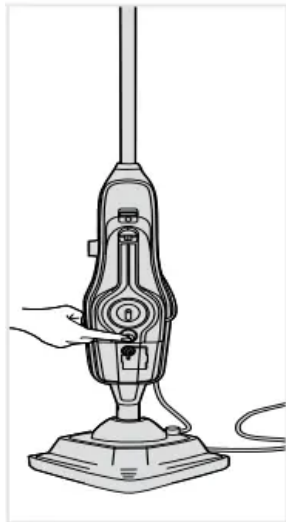



2 Plug into an outlet and Push On/Off switch to turn ON (I=ON). The blue light will illuminate to show power on. The green light will illuminate to show the steam mop is ready to use.



3 Adjust the steam dial to desired setting.

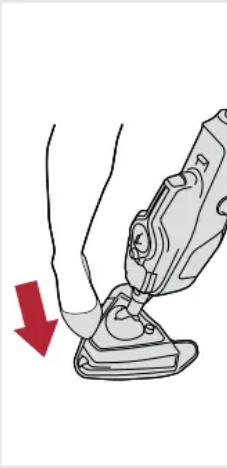

4 To steam your floors with solution turn the dial to ON (I=ON) and without solution turn the dial to OFF (0=OFF).

			<p>TO SANITIZE HARD SURFACES</p> <p>Turn the solution dial to "OFF" position and steam control dial to "MAX" position. Connect the microfiber pad and run a minimum of 6 strokes at a medium pace (5-7 seconds per 32" stroke) across same area. Allow to dry</p>
<p>5 To recline the steam mop place foot here and pull handle backwards.</p>	<p>6 To produce steam squeeze the trigger in short bursts. Don't hold the trigger continuously to prevent over saturating floors.</p>	<p>7 Move the steam mop slowly backwards and forwards across the floor. Squeeze and release trigger as required.</p>	

Refreshing carpets

WARNING To reduce the risk of personal injury - Unplug the steam cleaner when assembling the accessories.

WARNING Do not clean over floor electrical outlets. Do not use steam cleaner or press the Steam Trigger without water in the water tank.

- **IMPORTANT** • When using on carpets, always ensure the multi-surface Microfiber Pad is properly attached to the Mop Head.



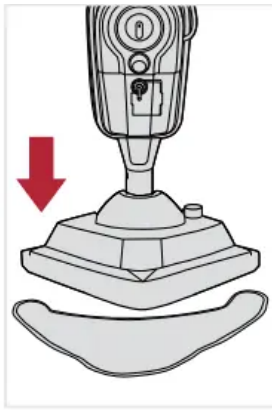

1 Place the microfiber pad on the floor white side facing up. Place steam mop onto pad making sure the entire pad covers the floor head.

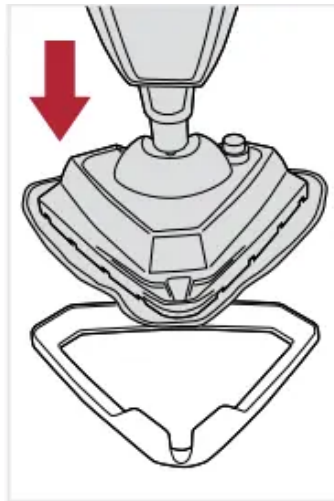

2 With microfiber pad attached, hook the steam mop into the front of the carpet glider and push to clip into place. Carpet glider should only be used when refreshing carpets.



3 Turn the solution dial to OFF when refreshing carpet.

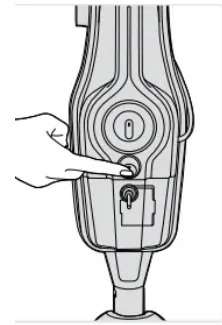

4 Push On/Off button to power on and off.



5 To recline the steam mop place foot on here and pull handle backwards.

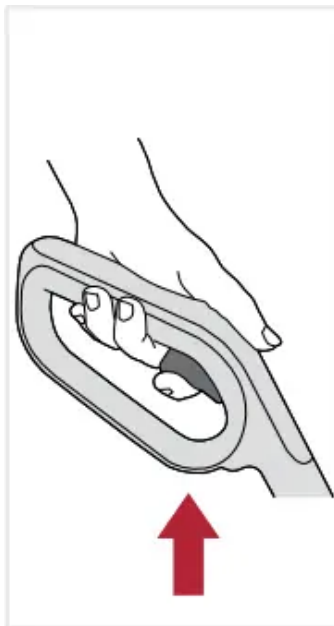

6 To produce steam, squeeze the trigger. To prevent overly wetting the carpet, avoid holding the trigger continuously.

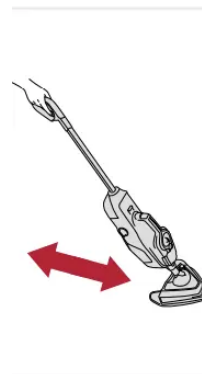

7 Move the steam mop slowly backwards and forwards across the carpet.





8 To release the carpet glider, place foot on clip and push down. Lift steam mop to unhook and remove.

Using tile and grout scrub brush and SteamStream™:

WARNING Do not clean over floor electrical outlets. Do not use steam cleaner or press the Steam Trigger without water in the water tank.

WARNING Scrub brush bristles may damage wood floors.

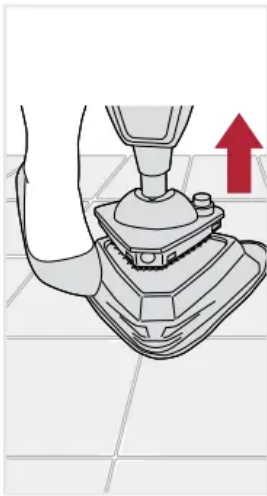
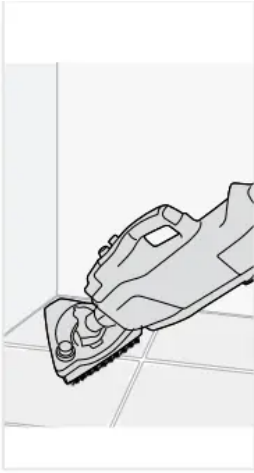
- **IMPORTANT** • Always switch off the steam mop before attaching or removing the floor head.
- **IMPORTANT** • Scrub brush only recommended for tile and grout cleaning only

		
<p>1 Place foot on outer floor head and gently pull away steam mop to release the tile and grout scrub brush.</p>	<p>2 Move steam mop back and forth across the floor, getting into corners and awkward places.</p>	<p>3 To engage SteamStream™ from the front nozzle, press the SteamStream™ button to activate, and squeeze the trigger to release steam. Press the SteamStream™ button to turn OFF (0=OFF).</p>

Using the handheld steamer:

WARNING Turn off, unplug and allow steam cleaner to cool before servicing or filling water tank.

CAUTION Turn off, unplug and allow steam cleaner to cool before removing accessories. Always have the nozzle pointed away from you and others during installation.



1 Lift the handheld release button and gently pull the handheld to release from the steam mop.

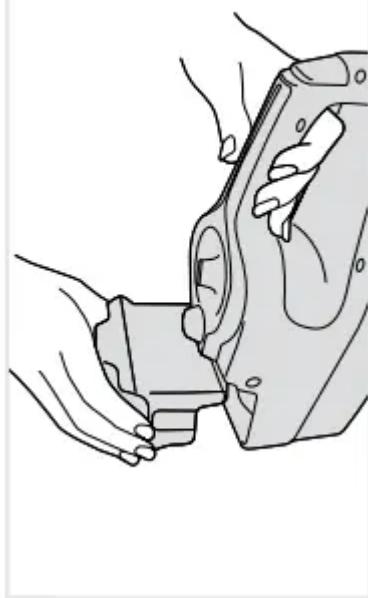

2 Remove water tank and refill before use.



3 When using the handheld always attach the concentration nozzle or hose. Push onto the handheld nozzle and twist clockwise to lock into position.



4 Adjust the dial on the front of the handheld to desired steam setting.

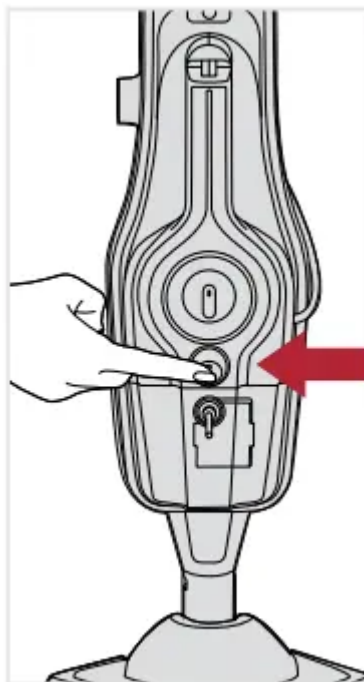

5 To Turn unit ON, push switch to (I=ON).



6 To produce steam push the trigger with your thumb in short bursts. Don't hold the trigger continuously to prevent over wetting.

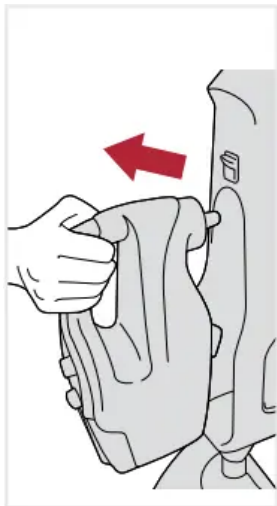

7 Insert the handheld back into the machine until it clicks into place.

WARNING To avoid burn injury, do not touch the steam cleaning nozzle or adjacent surfaces when steam cleaning or when the nozzle is heated.

Using small accessories:

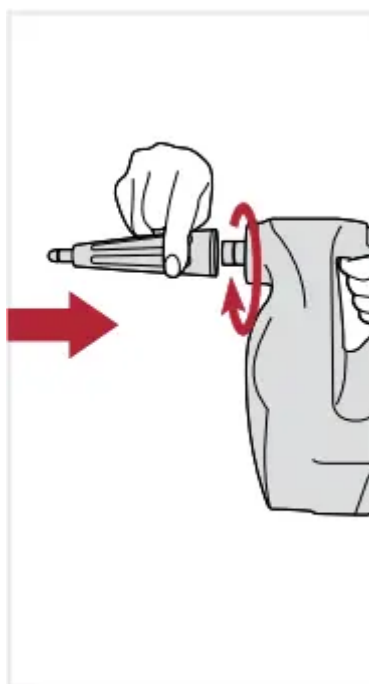

1 Small tools can be attached via concentration nozzle. Twist clockwise until locked into position and secure. To remove concentration nozzle, turn counter-clockwise.



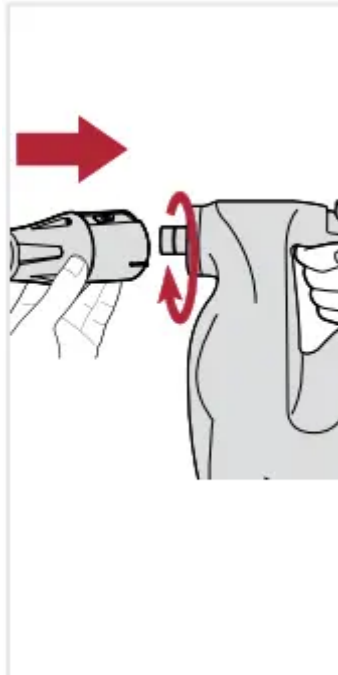

CAUTION Turn off, unplug, and allow steam cleaner to cool before removing accessories. Always have the nozzle pointed away from you and others during installation.

Using large accessories:

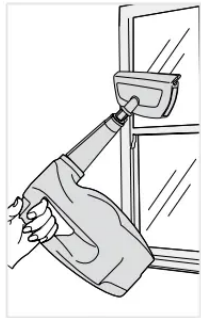
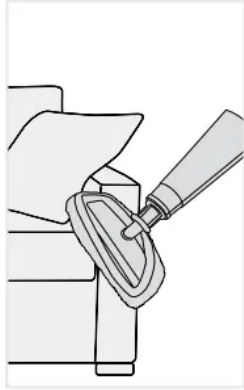
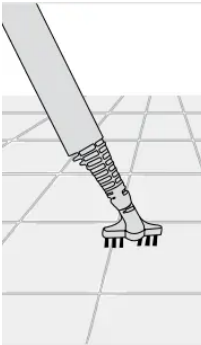

1 Larger accessories can be attached using the concentration nozzle or hose. To attach the hose twist clockwise until locked into position and secure. To remove hose, turn counter-clockwise.

Using the tools:

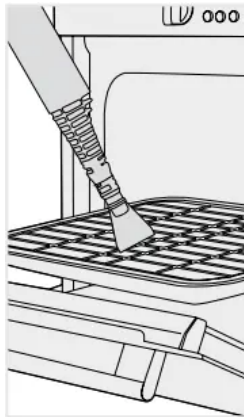
<p>Concentration nozzle</p>  <p>1 Use to remove soap scum in baths and shower enclosures and to clean heavily soiled areas in kitchens.</p>	<p>Brushes</p>  <p>2 Ideal for any surface from tiles, sinks, toilets and oven tops.</p>	<p>Squeegee tool*</p>  <p>3 Great for leaving your windows, tiles and mirrors gleaming.</p> <p>* Select models only</p>	<p>Upholstery/ cloth tool*</p>  <p>4 Attach the cloth to the squeegee tool for use on upholstery and clothes.</p> <p>* Select models only</p>
<p>• IMPORTANT •</p> <p>Faucets should be turned off when steaming around them. Don't steam clean ovens, oven surfaces or grills when hot. Allow to cool to room temperature.</p>	<p>Grout brush</p>  <p>5 Lifts embedded dirt from in between tiles.</p>	<p>Detail nozzle</p>  <p>6 For hard-to-reach areas e.g. around faucets.</p>	<p>Scraper nozzle</p>  <p>7 Ideal for removing dried on residue from ovens, work surfaces and pans.</p>

Maintenance

If steam cleaner is not working as it should, has been dropped, damaged, left outdoors, or dropped into water, call Customer Service at 1-800-944-9200 for further instruction before continuing use.

This steam cleaner contains no user serviceable parts. Do not try to repair it yourself.

• IMPORTANT •

Allow the steam mop to fully cool down before performing any maintenance or troubleshooting checks.

Emptying the water tank

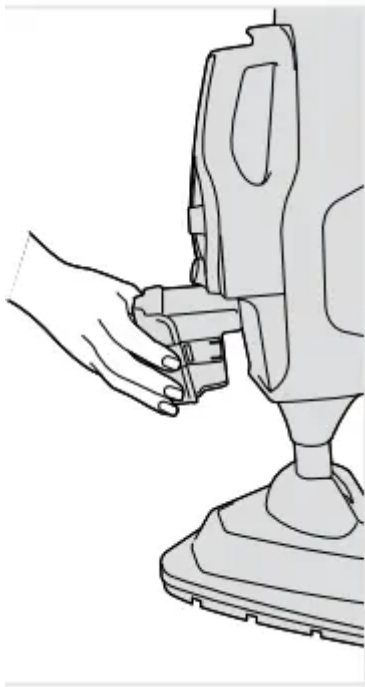

1 Press the water tank release button and lift the water tank by the handle.

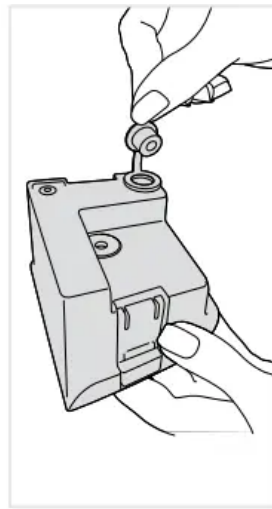

2 Pull the tab on the water tank to open.

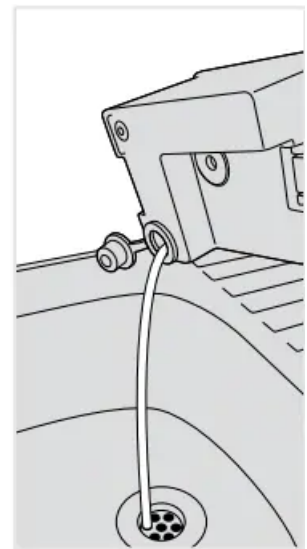

3 Empty any excess water over the sink.

Emptying the solution tank

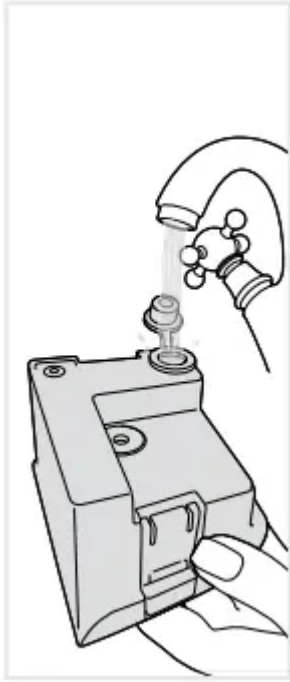

4 Rinse water tank with water and push water tank tab firmly to close before replacing back onto the machine.

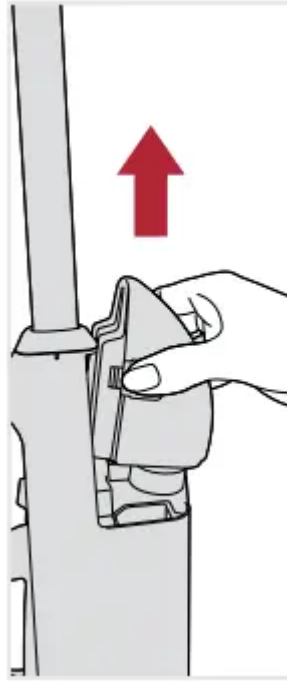

5 Push both solution tank release buttons then lift to remove



6 Twist solution cap counter-clockwise and lift to remove.



7 Empty any excess solution over the sink.



8 Rinse solution tank with water and replace solution tank cap, turn clockwise to tighten before replacing back onto the machine.

Removing cleaning pads

WARNING To reduce the risk of personal injury - Unplug Steam Mop before servicing and allow to cool.

- **IMPORTANT** • Never use bleach or fabric softener when washing the pad.

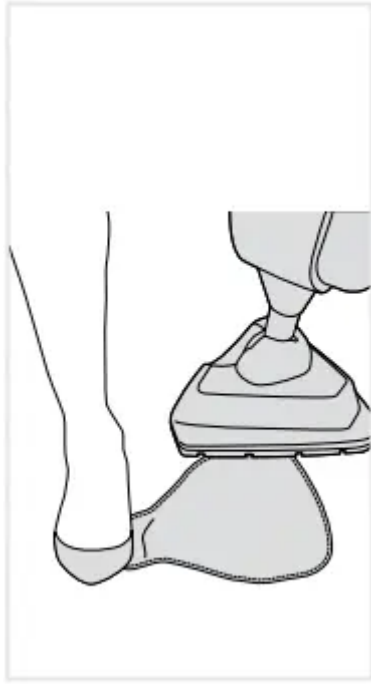

1 Hold corner of pad down with foot and lift steam mop to peel away.







2 All cleaning pads are machine washable on WARM setting. For best results lay flat to dry. Allow to fully dry before use.

Replacing the hard water filter

WARNING To reduce the risk of personal injury - Unplug Steam Mop before servicing and allow to cool.

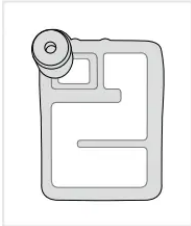
• **IMPORTANT** • The condition of the filter affects the performance of your machine. Check and change filter (depending on level of use and water conditions in your area). Do not operate Steam Mop without Water Filter in place.

 <p>1 Remove the water tank to access the hard water filter.</p>	 <p>2 Pull to remove the hard water filter.</p>	 <p>3 New filter has a (beige/cream color).</p>	<p>3-6 Months</p>  <p>4 Hard water filter should be replaced every 6-8 months or when discolored.</p>
---	--	--	---

Clearing blockages

WARNING To reduce the risk of personal injury - Unplug Steam Mop before servicing and allow to cool.

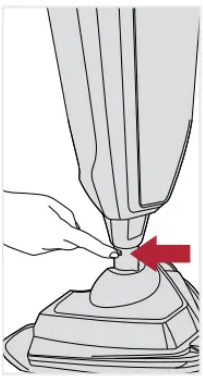
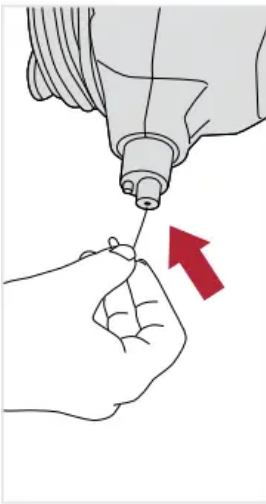
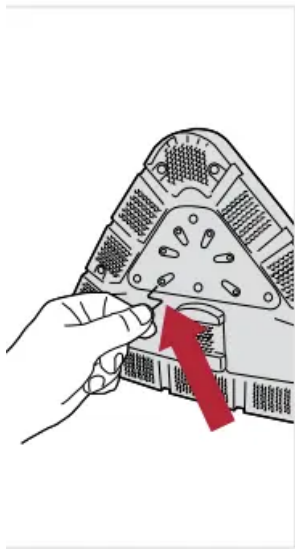
 <p>1 If there is an obstruction to the steam flow through the machine, steam may release through the bleed valve.</p>	 <p>2 To remove the floor head from the body push the floor head release button and lift.</p>	 <p>3 After the floor head is removed, use a thin object such as a paperclip (in the area shown), to remove the blockage.</p>	 <p>4 With the pad removed from the floor head, insert a small thin object such as a paper-clip in to the steam holes to remove a blockage.</p>
---	--	---	--

Storage

- Unplug the power cord.
- Allow time to cool.
- Empty the residual fluid from the twin tank and clean the external surface with a dry cloth. Allow to dry.
- Re-install twin tank.
- You may leave solution in solution tank for short period of time, but if you are going to leave solution in tank for more than 2 weeks, it is recommended to empty the solution tank.

Troubleshooting

This Steam Cleaner contains no user serviceable parts. Do not try to repair it yourself.

USE TROUBLESHOOTING GUIDE AS A FIRST STEP TO RESOLVE ANY PROBLEMS YOU MAY BE EXPERIENCING.

If steam cleaner is not working as it should, has been dropped, damaged, left outdoors, or dropped into water, call Customer Service at 1-800-944-9200 for further instruction before continuing use.

WARNING To reduce the risk of personal injury - Unplug Steam Mop before servicing and allow to cool.

PROBLEM	POSSIBLE CAUSE	POSSIBLE SOLUTION
Steam Mop won't run	<ol style="list-style-type: none"> 1. No voltage in wall plug. 2. Blown fuse or tripped breaker. 3. Steam cleaner may not be plugged into the electrical outlet correctly. 4. The electrical outlet may not be working properly, check the fuse or breaker, or consult an electrician. 5. The power cord may be damaged. 6. Does not turn on. 	<ol style="list-style-type: none"> 1. Check fuse or breaker in home. 2. Replace fuse or reset breaker in home. 3. Ensure the plug is pushed in securely. 4. Check fuse or breaker in home. Replace fuse/reset breaker in home. 5. If cord is damaged have it replaced by an authorized service representative. 6. Check the On/Off switch to make sure it is in the On position.
Steam mop not producing steam	<ol style="list-style-type: none"> 1. Water tank may be empty. 2. The water tank may not be attached correctly. 3. Water Filter may be clogged and needs to be replaced. 4. Thermal protector may turn off pump if trying to operate steam cleaner before steam indicator is illuminated. 5. Steam path may be blocked. 	<ol style="list-style-type: none"> 1. Please refer to the "Filling Tanks" section. 2. Please refer to the "Filling Twin Tank" section, and ensure tank is fully seated. 3. Check Water Filter and clean or replace. 4. Unplug steam cleaner and allow to cool down 5. Please refer to the "Clearing Blockages" section.
Microfiber pad doesn't pick up dirt	<ol style="list-style-type: none"> 1. The cleaning pad may already be saturated with dirt and needs washing. 	<ol style="list-style-type: none"> 1. Wash or replace with clean pad. Please refer to the "Removing Cleaning Pads" section.

Warning

This content is compiled from multiple sources and is provided for reference purposes only. It may not be complete or fully applicable to all situations. If you are unable to resolve your issue, please contact the product manufacturer or an authorized service provider for official support.



