

Operating Instructions

About the features of your microwave oven.

Throughout this manual, features and appearance may vary from your model.

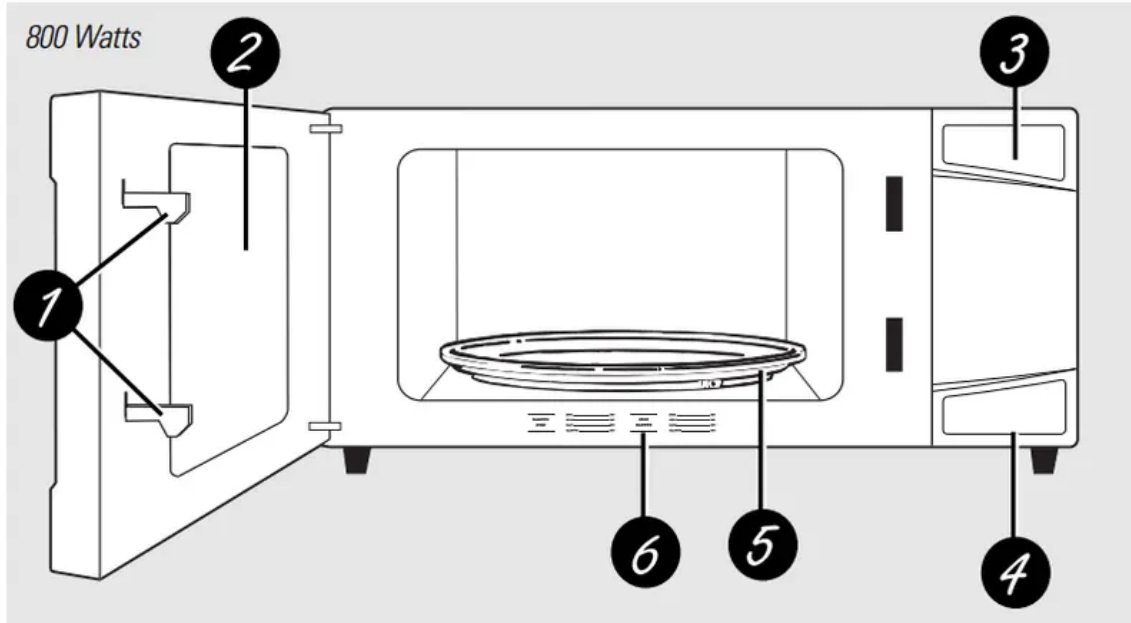

1. **Door Latches.**

2. **Window with Metal Shield.** Screen allows cooking to be viewed while keeping microwaves confined in the oven.

3. **Touch Control Panel Display.**

4. **Door Latch Release.** Press latch release to open door.

5. **Removable Turntable.** Turntable and support must be in place when using the oven. The turntable may be removed for cleaning.

6. **Convenience Guide.**

NOTE: Rating plate, oven vent(s) and oven light are located on the inside walls of the microwave oven.

You can microwave by time, with the sensor features or with the auto feature.

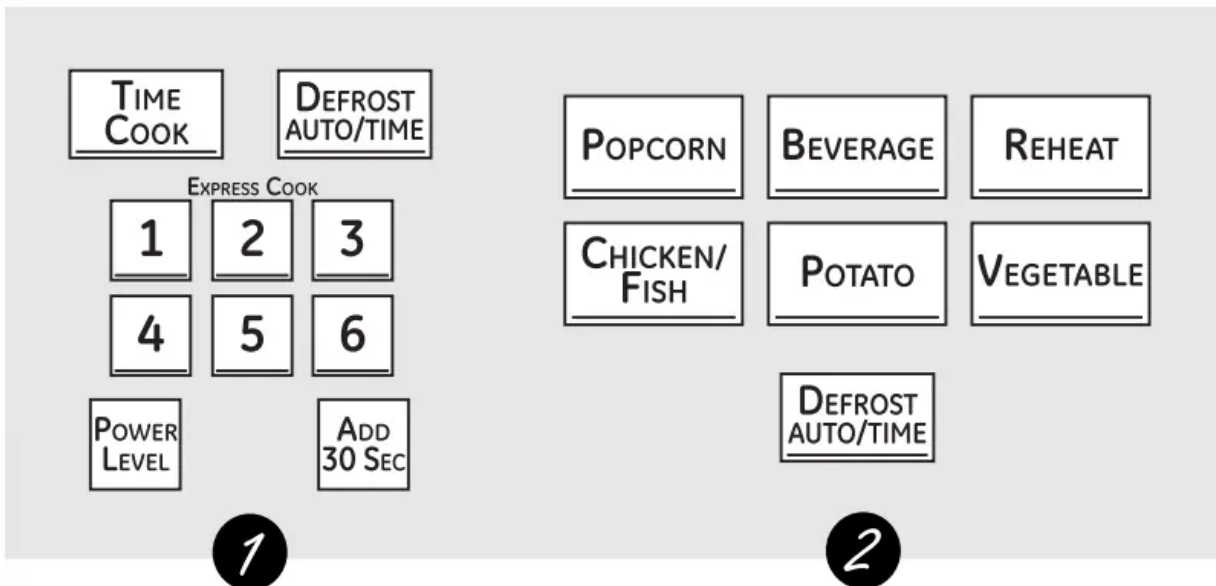

Cooking Controls

Check the Convenience Guide before you begin.



1

Time Features

Press	Enter
TIME COOK Press once or twice	Amount of cooking time
DEFROST AUTO/TIME Press twice	Amount of defrosting time
EXPRESS COOK	Starts immediately!
ADD 30 SEC	Starts immediately!
POWER LEVEL	Power level 1–10

2

Sensor Features and Auto Feature

Press	Enter	Option
POPCORN	Starts immediately!	more/less time
BEVERAGE	Starts immediately!	
REHEAT	Starts immediately!	more/less time
CHICKEN/FISH Press once (chicken pieces) Press twice (fish fillets)	Starts immediately!	more/less time
POTATO	Starts immediately!	more/less time
VEGETABLE Press once (fresh vegetables) Press twice (frozen vegetables) Press three times (canned vegetables)	Starts immediately!	more/less time more/less time more/less time (on some models)
DEFROST AUTO/TIME Press once	Food weight	

About changing the power level.

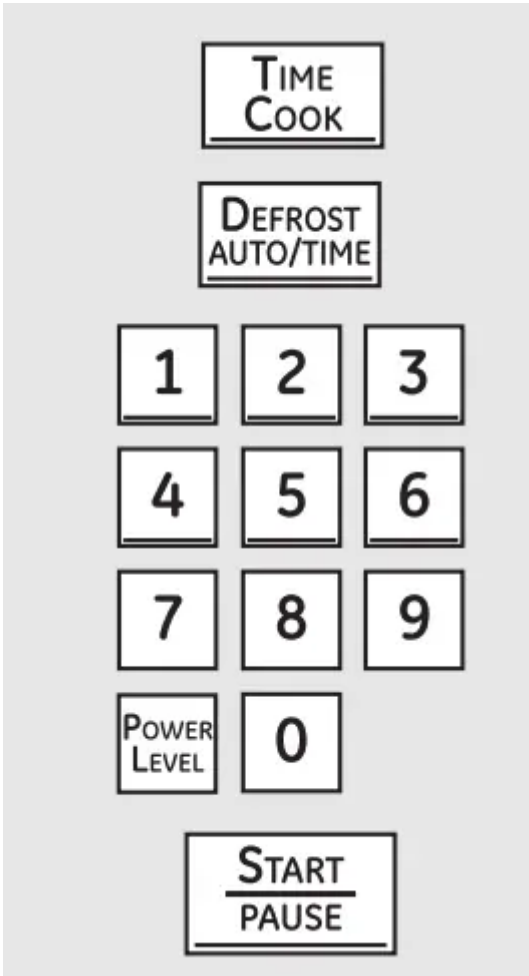

The power level may be entered or changed immediately after entering the feature time for TIME COOK, TIME DEFROST or EXPRESS COOK. The power level may also be changed during time countdown.

1. Press TIME COOK or select Time Defrost.
2. Enter cooking or defrosting time.
3. Press POWER LEVEL.
4. Select desired power level 1–10.
5. Press START

Variable power levels add flexibility to microwave cooking. The power levels on the microwave oven can be compared to the surface units on a range. Each power level gives you microwave energy a certain percent of the time. **Power level 7** is microwave energy 70% of the time. **Power level 3** is energy 30% of the time. Most cooking will be done on **High (power level 10)** which gives you 100% power. **Power level 10** will cook faster but food may need more frequent stirring, rotating or turning over. A lower setting will cook more evenly and need less stirring or rotating of the food. Some foods may have better flavor,

texture or appearance if one of the lower settings is used. Use a lower power level when cooking foods that have a tendency to boil over, such as scalloped potatoes.

Rest periods (when the microwave energy cycles off) give time for the food to “equalize” or transfer heat to the inside of the food. An example of this is shown with **power level 3**—the defrost cycle. If microwave energy did not cycle off, the outside of the food would cook before the inside was defrosted.

Here are some examples of uses for various power levels:

High 10: Fish, bacon, vegetables, boiling liquids.

Med-High 7: Gentle cooking of meat and poultry; baking casseroles and reheating.

Medium 5: Slow cooking and tenderizing for stews and less tender cuts of meat.

Low 2 or 3: Defrosting; simmering; delicate sauces.

Warm 1: Keeping food warm; softening butter.

About the time features

Time Cook

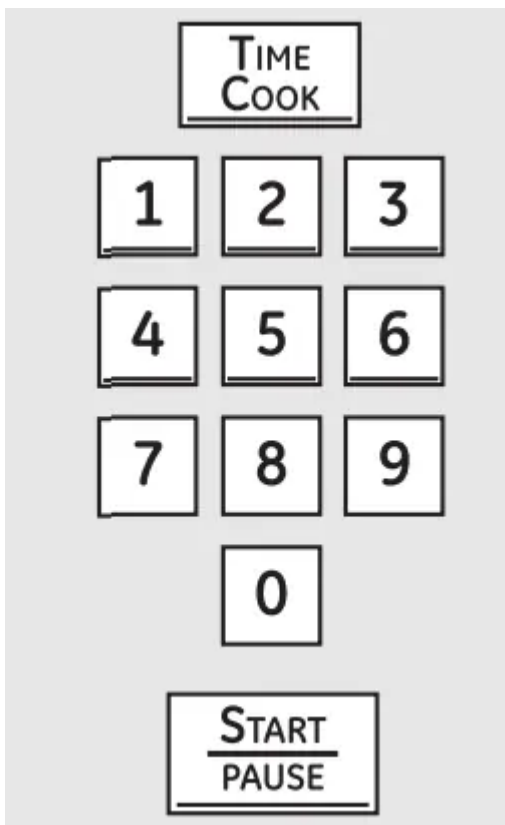

Time Cook I

Allows you to microwave for any time up to 99 minutes and 99 seconds.

Power level 10 (High) is automatically set, but you may change it for more flexibility.

1. Press TIME COOK.
2. Enter cooking time.

3. Change power level if you don't want full power. (Press POWER LEVEL. Select a desired power level 1–10.)

4. Press START

You may open the door during Time Cook to check the food. Close the door and press START to resume cooking.

Time Cook II

Lets you change power levels automatically during cooking. Here's how to do it:

1. Press TIME COOK.

2. Enter the first cook time.

3. Change the power level if you don't want full power. (Press POWER LEVEL. Select a desired power level 1–10.)

4. Press TIME COOK again.

5. Enter the second cook time.

6. Change the power level if you don't want full power. (Press POWER LEVEL. Select a desired power level 1–10.)

7. Press START.

At the end of **Time Cook I**, **Time Cook II** counts down.

Time Defrost

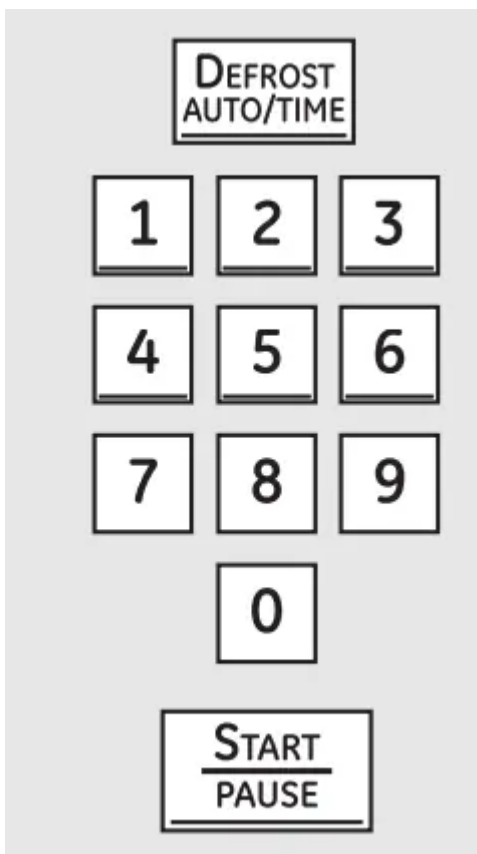

Allows you to defrost for a selected length of time. See the Defrosting Guide for suggested times. (Auto Defrost explained in the About the auto feature section.)

1. Press DEFROST AUTO/TIME twice.
2. Enter defrosting time.
3. Press START.
4. Turn food over when the oven signals.
5. Press START

Power level is automatically set at 3, but can be changed. You can defrost small items quickly by raising the power level after entering the time. Power level 7 cuts the total defrosting time in about half; power level 10 cuts the total time to approximately 1/3. However, food will need more frequent attention than usual.

At one half of selected defrosting time, the oven signals TURN. At this time, turn food over and break apart or rearrange pieces for more even defrosting. Shield any warm areas with small pieces of foil.

A dull thumping noise may be heard during defrosting. This is normal when oven is not operating at High power.

Defrosting Tips

- Foods frozen in paper or plastic can be defrosted in the package. Closed packages should be slit, pierced or vented AFTER food has partially defrosted. Plastic storage containers should be partially uncovered.
- Family-size, prepackaged frozen dinners can be defrosted and microwaved. If the food is in a foil container, transfer it to a microwave-safe dish.
- Foods that spoil easily should not be allowed to sit out for more than one hour after defrosting. Room temperature promotes the growth of harmful bacteria.
- For more even defrosting of larger foods, such as roasts, use Auto Defrost. Be sure large meats are completely defrosted before cooking.
- When defrosted, food should be cool but softened in all areas. If still slightly icy, return to the microwave very briefly or let it stand a few minutes.

Express Cook

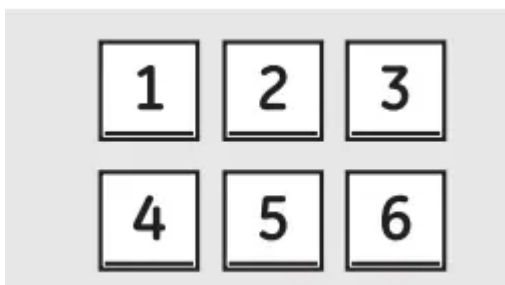

This is a quick way to set cooking time for 1–6 minutes.

Press one of the Express Cook pads (from 1 to 6) for 1 to 6 minutes of cooking at power level 10. For example, press the 2 pad for 2 minutes of cooking time.

The power level can be changed as time is counting down. Press POWER LEVEL and enter 1–10.

Add 30 Seconds



You can use this feature two ways:

- It will add 30 seconds to the time counting down each time the pad is pressed.
- It can be used as a quick way to set 30 seconds of cooking time.

About the other features.

Help

The HELP pad displays feature information and helpful hints. Press HELP, then select a feature pad.

Cooking Complete Reminder

To remind you that you have food in the oven, the oven will display FOOD IS READY and beep once a minute until you either open the oven door or press CLEAR/OFF.

Clock

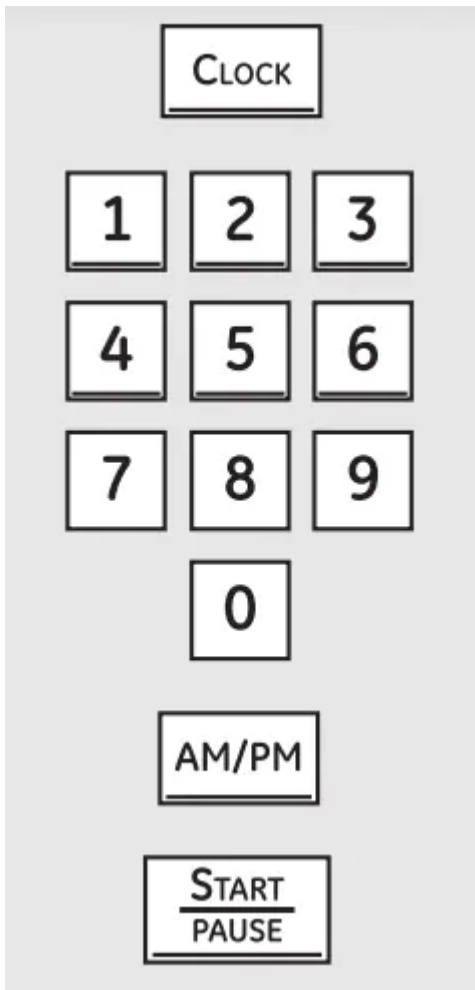

Press to enter the time of day or to check the time of day while microwaving.

1. Press CLOCK.
2. Enter time of day.
3. Select AM or PM.
4. Press START or CLOCK

Scroll Speed

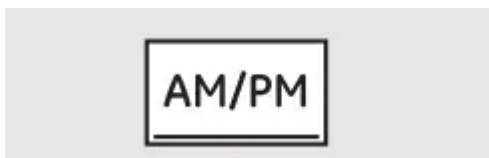

The scroll speed of the display can be changed. Press and hold the **AM/PM** pad about 3 seconds to bring up the display. Select 1–5 for slow to fast scroll speed.

Start/Pause

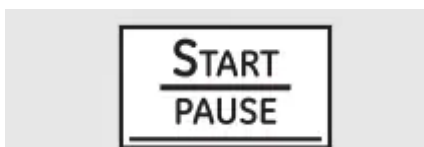

In addition to starting many functions, START/PAUSE allows you to stop cooking without opening the door or clearing the display

Reminder

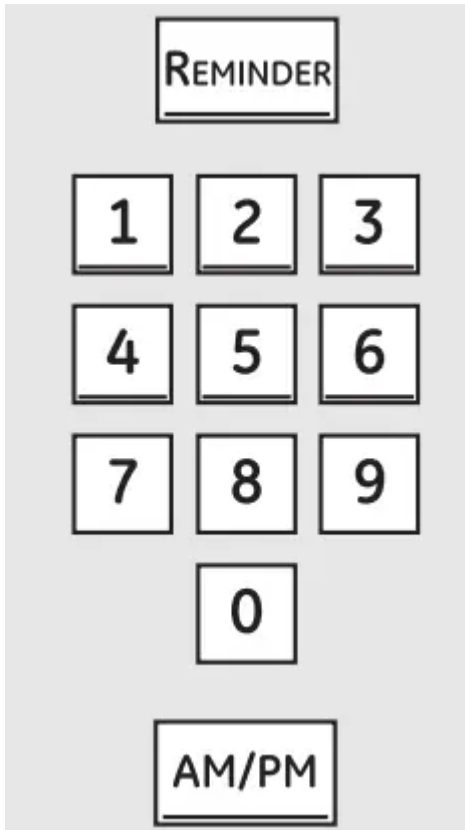

The Reminder feature can be used like an alarm clock and can be used at any time, even when the oven is operating. The Reminder time can be set up to 24 hours later.

1. Press REMINDER.
2. Enter the time you want the oven to remind you. (Be sure the microwave clock shows the correct time of day.)
3. Select AM or PM.
4. Press REMINDER. When Reminder signal occurs, press REMINDER to turn it off. The Reminder time may be displayed by pressing REMINDER.

NOTE: The REM indicator will remain lit to show that the Reminder is set. To clear the Reminder before it occurs, press REMINDER, then 0. The REM indicator will no longer be lit.

Delay Start

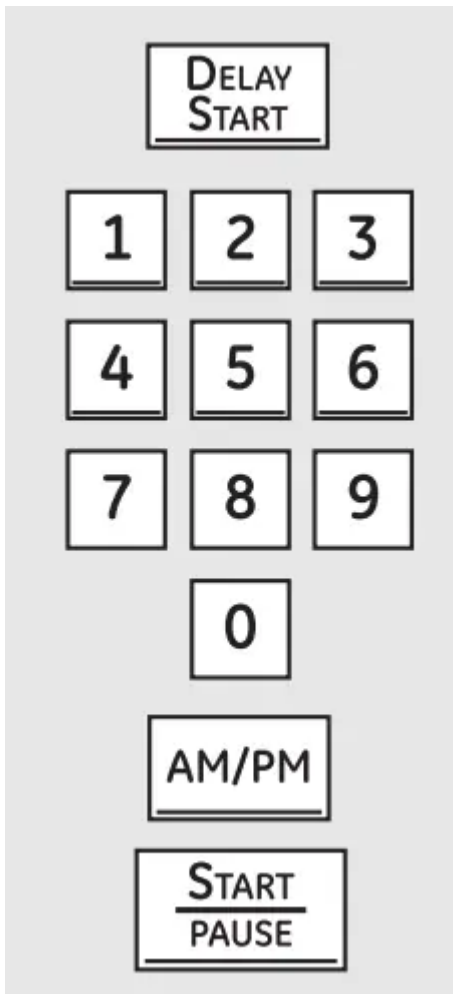

Delay Start allows you to set the microwave to delay cooking up to 24 hours.

1. Press DELAY START.
2. Enter the time you want the oven to start. (Be sure the microwave clock shows the correct time of day.)
3. Select AM or PM.
4. Select any combination of Defrost Auto/Time and Time Cook.
5. Press START.

The Delay Start time will be displayed plus DS. The oven will automatically start at the delayed time. The time of day may be displayed by pressing CLOCK.

Child Lock-Out

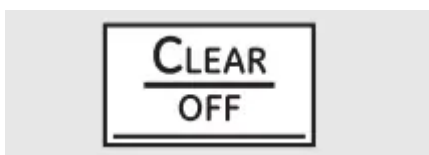

You may lock the control panel to prevent the microwave from being accidentally started or used by children. To lock or unlock the controls, press and hold CLEAR/OFF for about three seconds. When the control panel is locked, an L will be displayed to the extreme right.

Turntable



For best cooking results, leave the turntable on. It can be turned off for large dishes. Press TURNTABLE to turn the turntable on or off. Sometimes the turntable can become too hot to touch. Be careful touching the turntable during and after cooking

Timer On/Off

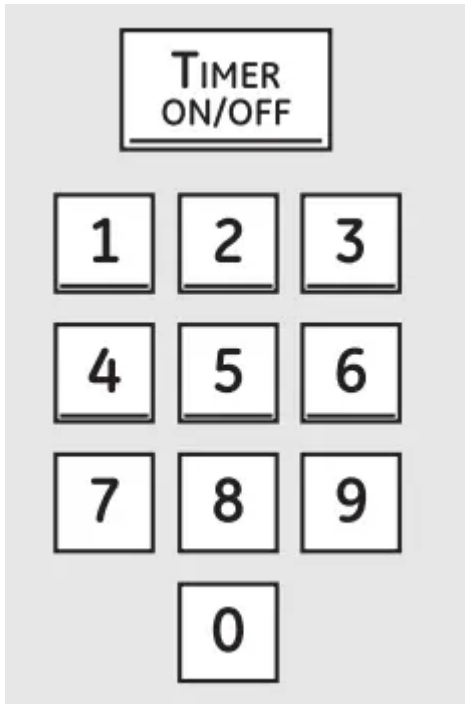

Timer On/Off operates as a minute timer and can be used at any time, even when the oven is operating.

1. Press TIMER ON/OFF.
2. Enter time you want to count down.
3. Press TIMER ON/OFF to start.

When time is up, the oven will signal. To turn off the timer signal, press TIMER ON/OFF.

NOTE: The timer indicator will be lit while the timer is operating.

Display On/Off

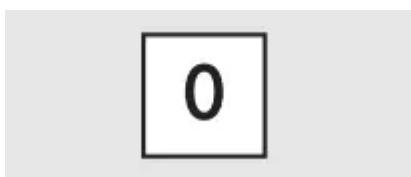

To turn the clock display on or off, press and hold **0** for about 3 seconds. The **Display On/Off** feature cannot be used while a cooking feature is in use.

Microwave terms.

Term	Definition
Arcing	<p>Arcing is the microwave term for sparks in the oven. Arcing is caused by:</p> <ul style="list-style-type: none"> • metal or foil touching the side of the oven. • foil that is not molded to food (upturned edges act like antennas). • metal such as twist-ties, poultry pins, gold-rimmed dishes. • recycled paper towels containing small metal pieces
Covering	Covers hold in moisture, allow for more even heating and reduce cooking time. Venting plastic wrap or covering with wax paper allows excess steam to escape.
Shielding	In a regular oven, you shield chicken breasts or baked foods to prevent over-browning. When microwaving, you use small strips of foil to shield thin parts, such as the tips of wings and legs on poultry, which would cook before larger parts.
Standing	Time When you cook with regular ovens, foods such as roasts or cakes are allowed to stand to finish cooking or to set. Standing time is especially important in microwave cooking. Note that a microwaved cake is not placed on a cooling rack.
Venting	After covering a dish with plastic wrap, you vent the plastic wrap by turning back one corner so excess steam can escape.

Care and cleaning of the microwave oven.

Helpful Hints



An occasional thorough wiping with a solution of baking soda and water keeps the inside fresh. Unplug the cord before cleaning any part of this oven.

How to Clean the Inside

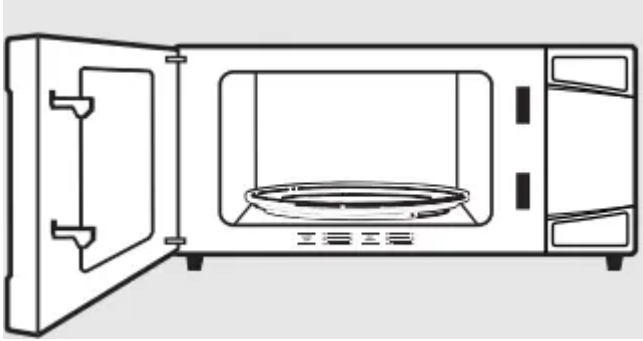

Walls, Floor, Inside Window, Metal and Plastic Parts on the Door

Some spatters can be removed with a paper towel; others may require a damp cloth. Remove greasy spatters with a sudsy cloth, then rinse with a damp cloth. Do not use abrasive cleaners or sharp utensils on oven walls.

To clean the surface of the door and the surface of the oven that come together upon closing, use only mild, nonabrasive soaps or detergents using a sponge or soft cloth. Rinse with a damp cloth and dry

Never use a commercial oven cleaner on any part of your microwave.

Removable Turntable and Turntable Support

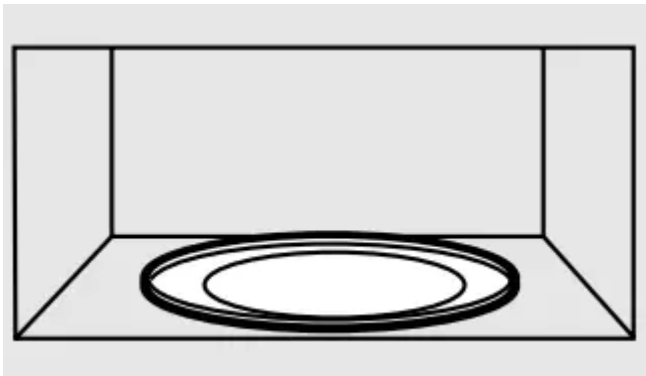

To prevent breakage, do not place the turntable into water just after cooking. Wash it carefully in warm, sudsy water or in the dishwasher. The turntable and support can be broken if dropped. Remember, do not operate the oven without the turntable and support in place.

How to Clean the Outside

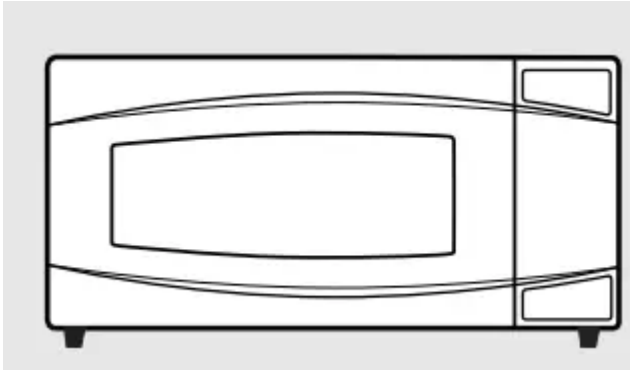

Do not use cleaners containing ammonia or alcohol on the microwave oven. Ammonia or alcohol can damage the appearance of the microwave.

- **Case** Clean the outside of the microwave with a sudsy cloth. Rinse and then dry. Wipe the window clean with a damp cloth.
- **Control Panel and Door** Wipe with a damp cloth. Dry thoroughly. Do not use cleaning sprays, large amounts of soap and water, abrasives or sharp objects on the panel—they can damage it. Some paper towels can also scratch the control panel.
- **Door Surface** It's important to keep the area clean where the door seals against the microwave. Use only mild, non-abrasive detergents applied with a clean sponge or soft cloth. Rinse well.
- **Stainless Steel (on some models)** Do not use a steel-wool pad; it will scratch the surface. To clean the stainless steel surface, use a hot, damp cloth with a mild detergent suitable for stainless steel surfaces. Use a clean, hot, damp cloth to remove soap. Dry with a dry, clean cloth. Always scrub lightly in the direction of the grain.

Troubleshooting Tips

Problem	Possible Causes	What To Do
Oven will not start	A fuse in your home may be blown or the circuit breaker tripped.	Replace fuse or reset circuit breaker.
	Power surge.	Unplug the microwave oven, then plug it back in.
	Plug not fully inserted into wall outlet.	Make sure the 3-prong plug on the oven is fully inserted into wall outlet.
	Door not securely closed.	Open the door and close securely
Control panel lighted, yet oven will not start	Door not securely closed.	Open the door and close securely
	START pad not pressed after entering cooking selection	Press START.
	Another selection entered already in oven and CLEAR/OFF pad not pressed to cancel it.	Press CLEAR/OFF.
	Cooking time not entered after pressing TIME COOK	Make sure you have entered cooking time after pressing TIME COOK.
	CLEAR/OFF was pressed accidentally	Reset cooking program and press START
	Food weight not entered after selecting Auto Defrost.	Make sure you have entered food weight after selecting Auto Defrost.
“SENSOR ERROR” appears on display	During Popcorn, Reheat, Beverage, Chicken/Fish, Potato, or Vegetable program, the door was opened before steam could be detected.	Close the door, press CLEAR/OFF and begin again.
	Steam was not detected in maximum amount of time.	Use Time Cook to heat for more time.

“LOCKED” appears in display	The control has been locked. (When the control panel is locked, an L will be displayed.)	Press and hold CLEAR/OFF for about three seconds to unlock the control.
Food amount too large	Sensor Reheat is for single servings of recommended foods.	Use Time Cook for large amounts of food.

Things That Are Normal With Your Microwave Oven

- Steam or vapor escaping from around the door.
- Light reflection around door or outer case.
- Dimming oven light and change in the blower sound at power levels other than high.
- Dull thumping sound while oven is operating.
- Turntable starts and stops automatically during **POPCORN**.
- TV/radio interference might be noticed while using the microwave. Similar to the interference caused by other small appliances, it does not indicate a problem with the microwave. Plug the microwave into a different electrical circuit, move the radio or TV as far away from the microwave as possible, or check the position and signal of the TV/radio antenna.

Warning

This content is compiled from multiple sources and is provided for reference purposes only. It may not be complete or fully applicable to all situations. If you are unable to resolve your issue, please contact the product manufacturer or an authorized service provider for official support.