

Operating Instructions

About the features of your oven.

Throughout this manual, features and appearance may vary from your model.

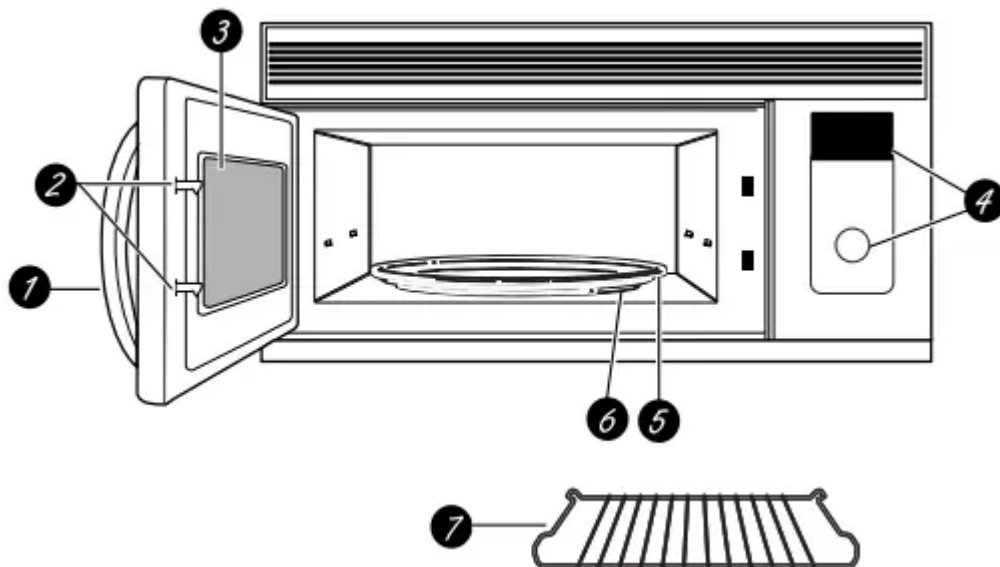

Features of the Oven

1. Door Latch Release Handle.
2. Door Latches.
3. Window with Metal Shield. Screen allows cooking to be viewed while keeping microwaves confined in the oven.
4. Control Panel and Selector Dial.
5. Removable Turntable. Turntable and support must be in place when using the oven. The turntable may be removed for cleaning.
6. Removable Turntable Support. The turntable support must be in place when using the oven.
7. Shelf. Use with Bake or Fast Bake. (Do not use when microwave cooking.) For best results, use the shelf in its “low” position, hanging down from the shelf supports.

About the cooking features of your microwave/convection oven.

You can cook by Microwave, Baking or Fast Baking.

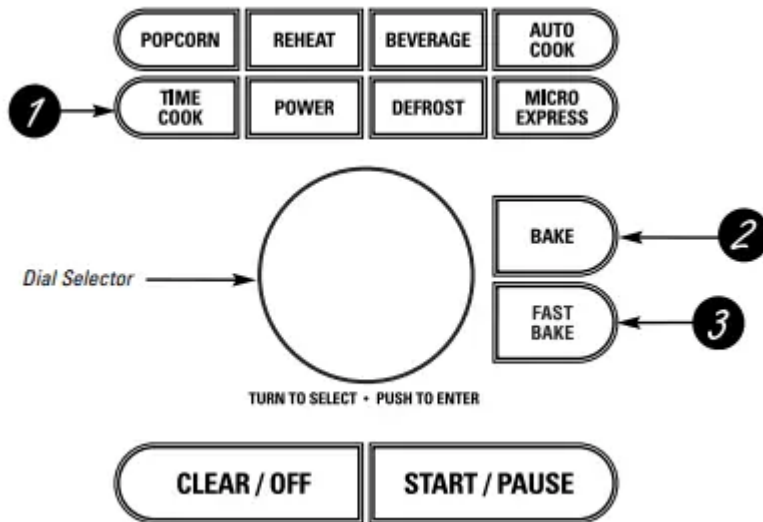

Cooking Controls

1 Microwave Cooking Time and Auto Features

<i>Press</i>	<i>Turn and push dial to enter</i>
TIME COOK Press once or twice	Amount of cooking time
MICRO EXPRESS cook/Add 30 sec.	Starts immediately!
DEFROST Press once (Time) Press twice (Auto) Press three times (Fast)	Amount of defrosting time Food weight up to six pounds Food weight up to one pound
POWER level	Power level 1–10

Sensor Features

<i>Press</i>	<i>Turn and push dial to enter</i>	<i>Option</i>
POPCORN Press once (regular) Press twice (snack)	Starts immediately!	more/less time
REHEAT Press once (plate) Press twice (½ to 1 cup) Press three times (1 to 2 cups)	Starts immediately!	more/less time
BEVERAGE	Starts immediately!	
AUTO COOK	Food type 1–7	more/less time

2 Baking

<i>Press</i>	<i>Turn and push dial to enter</i>
BAKE	Oven temperature and cook time

3 Fast Baking

<i>Press</i>	<i>Turn and push dial to enter</i>
FAST BAKE	Oven temperature and cook time

About the time and auto microwave features.

Using the Dial

TURN TO SELECT
PUSH TO ENTER

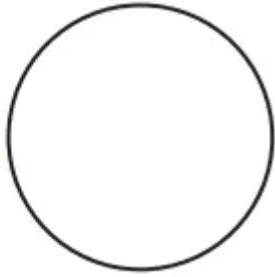

You can make selections on the oven by turning the dial and pressing it to enter the selection.

Pressing the dial can also be used in place of the START/PAUSE button for quicker programming of the oven.

Time Cook



TURN TO SELECT
PUSH TO ENTER

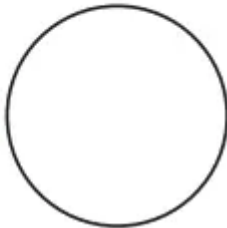

Time Cook I

Allows you to microwave for any time between 15 seconds and 95 minutes.

Power level 10 (High) is automatically set, but you may change it for more flexibility.

1. Press the TIME COOK button.
2. Turn the dial to set the cook time and press the dial to enter.
3. Change power level if you don't want full power. (Press POWER. Turn the dial to select. Press the dial to enter.)
4. Press the dial or the START/PAUSE button to start cooking.

You may open the door during Time Cook to check the food. Close the door and press the dial or START/PAUSE to resume cooking.

NOTE: You may change the cook time at any time during cooking by turning the dial. You may also change the power level by pressing the POWER button.

Time Cook II

Lets you change power levels automatically during cooking. Here's how to do it:

1. Press the TIME COOK button.
2. Turn the dial to set the first cook time and press the dial to enter.

3. Change the power level if you don't want full power. (Press POWER. Turn the dial to select. Press the dial to enter.)
4. Press the TIME COOK button again.
5. Turn the dial to set the second cook time and press the dial to enter.
6. Change the power level if you don't want full power. (Press POWER. Turn the dial to select. Press the dial to enter.)
7. Press the dial or the START/PAUSE button to start cooking.

At the end of Time Cook I, Time Cook II counts down.

NOTE: You may change the cook time at any time during cooking by turning the dial. You may also change the power level by pressing the POWER button.

Micro Express Cook

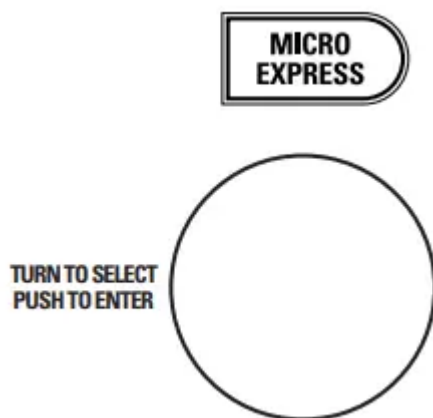

This is a quick way to set and start cooking in 30 second blocks each time the MICRO EXPRESS button is pressed. The cook time may be changed by turning the dial at any time during cooking

The power level will automatically be set at 10 and the oven will start immediately.

The power level can be changed as time is counting down. Press the POWER button, turn the dial and press to enter.

Time Defrost

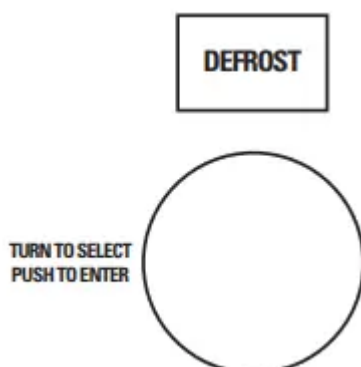

Use Time Defrost to defrost for a selected length of time.

1. Press the DEFROST button once.
2. Turn the dial to select the time you want. Press the dial to enter.
3. Press the START/PAUSE button to start defrosting.
4. Turn the food over if the oven signals TURN FOOD OVER.

You may change the defrost time at any time during defrosting by turning the dial.

Power level is automatically set at 3, but can be changed. You can defrost small items quickly by raising the power level after entering the time. Power level 7 cuts the total defrosting time in about half; power level 10 cuts the total time to approximately 1/3. However, food will need more frequent attention than usual.

A dull thumping noise may be heard during defrosting. This is normal when oven is not operating at High power.

Defrosting Tips

- Foods frozen in paper or plastic can be defrosted in the package. Closed packages should be slit, pierced or vented AFTER food has partially defrosted. Plastic storage containers should be partially uncovered.
- Family-size, prepackaged frozen dinners can be defrosted and microwaved. If the food is in a foil container, transfer it to a microwave-safe dish.
- Foods that spoil easily should not be allowed to sit out for more than one hour after defrosting. Room temperature promotes the growth of harmful bacteria.
- For more even defrosting of larger foods, such as roasts, use Auto Defrost. Be sure large meats are completely defrosted before cooking.
- When defrosted, food should be cool but softened in all areas. If still slightly icy, return to the microwave very briefly, or let it stand a few minutes.

Auto Defrost

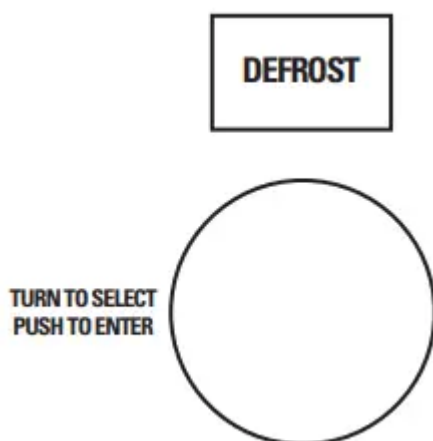

Use Auto Defrost for meat, poultry and fish weighing up to six pounds. Use Time Defrost for most other frozen foods.

Auto Defrost automatically sets the defrosting times and power levels to give even defrosting results for meats, poultry and fish.

- Remove meat from package and place on microwave-safe dish.

1. Press the DEFROST button twice.
2. Turn the dial to the food weight, using the Conversion Guide at right. For example, dial 1.2 for 1.2 pounds (1 pound, 3 oz.) Press the dial to enter.
3. Press the START/PAUSE button to start defrosting.
4. Turn the food over if the oven signals TURN FOOD OVER.

- Remove defrosted meat or shield warm areas with small pieces of foil.
- After defrosting, most meats need to stand 5 minutes to complete defrosting. Large roasts should stand for about 30 minutes.

Conversion Guide

If the weight of food is stated in pounds and ounces, the ounces must be converted to tenths (.1) of a pound

<i>Weight of Food in Ounces</i>	<i>Enter Food Weight (tenths of a pound)</i>
<i>1-2</i>	<i>.1</i>
<i>3</i>	<i>.2</i>
<i>4-5</i>	<i>.3</i>
<i>6-7</i>	<i>.4</i>
<i>8</i>	<i>.5</i>
<i>9-10</i>	<i>.6</i>
<i>11</i>	<i>.7</i>
<i>12-13</i>	<i>.8</i>
<i>14-15</i>	<i>.9</i>

Fast Defrost



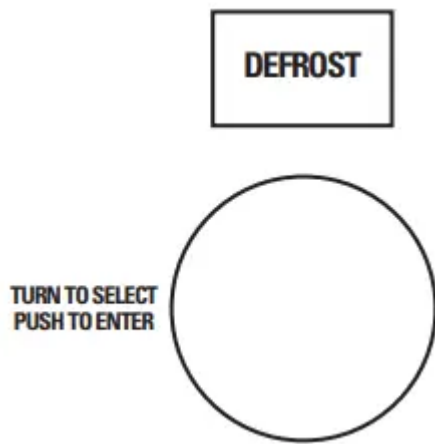

Fast Defrost automatically sets the defrosting times and power levels to give even defrosting results for meats, poultry and fish weighing up to one pound.

- Remove meat from package and place on microwave-safe dish.
1. Press the DEFROST button three times.
 2. Turn the dial to the food weight, using the Conversion Guide at right. For example, dial .5 for .5 pounds (8 oz.) Press the dial to enter.
 3. Press the START/PAUSE button to start defrosting.
 4. Turn the food over if the oven signals TURN FOOD OVER.
- Remove defrosted meat or shield warm areas with small pieces of foil.
 - After defrosting, most meats need to stand 5 minutes to complete defrosting.

Conversion Guide

If the weight of food is stated in pounds and ounces, the ounces must be converted to tenths (.1) of a pound.

<i>Weight of Food in Ounces</i>	<i>Enter Food Weight (tenths of a pound)</i>
<i>1-2</i>	<i>.1</i>
<i>3</i>	<i>.2</i>
<i>4-5</i>	<i>.3</i>
<i>6-7</i>	<i>.4</i>
<i>8</i>	<i>.5</i>
<i>9-10</i>	<i>.6</i>
<i>11</i>	<i>.7</i>
<i>12-13</i>	<i>.8</i>
<i>14-15</i>	<i>.9</i>

About changing the power level.

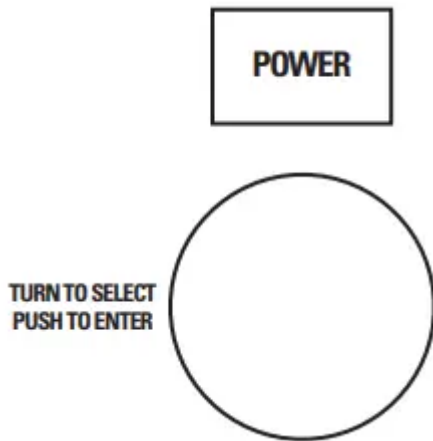

The power level may be entered or changed immediately after entering the time for Time Cook, Time Defrost or Express Cook. The power level may also be changed during time countdown.

1. First, follow directions for Time Cook, Time Defrost or Express Cook.
2. Press the POWER button.
3. Turn the dial clockwise to increase and counterclockwise to decrease the power level. Press the dial to enter.
4. Press the START/PAUSE button to start cooking.

Variable power levels add flexibility to microwave cooking. The power levels on the microwave oven can be compared to the surface units on a range. Each power level gives you microwave energy a certain percent of the time. Power level 7 is microwave energy 70% of the time. Power level 3 is energy 30% of the time. Most cooking will be done on High (power level 10) which gives you 100% power. Power level 10 will cook faster but food may need more frequent stirring, rotating or turning over. A lower setting will cook more evenly and need less stirring or rotating of the food. Some foods may have better flavor, texture or appearance if one of the lower settings is used. Use a lower power level when cooking foods that have a tendency to boil over, such as scalloped potatoes.

Rest periods (when the microwave energy cycles off) give time for the food to “equalize” or transfer heat to the inside of the food. An example of this is shown with power level 3—the defrost cycle. If microwave energy did not cycle off, the outside of the food would cook before the inside was defrosted.

Here are some examples of uses for various power levels:

High 10: Fish, bacon, vegetables, boiling liquids.

Med-High 7: Gentle cooking of meat and poultry; baking casseroles and reheating.

Medium 5: Slow cooking and tenderizing for stews and less tender cuts of meat.

Low 2 or 3: Defrosting; simmering; delicate sauces.

Warm 1: Keeping food warm; softening butter.

Auto Cook



Because most cooking containers must be covered during Auto Cook, this feature is best with foods that you want to steam or retain moisture.

NOTE: Use of the metal shelf with Auto Cook is not recommended.

Recommended Foods

A wide variety of foods including meats, fish and vegetables can be cooked using this feature.



Foods not recommended

Foods that must be cooked uncovered, foods that require constant attention, foods that require addition of ingredients during cooking and foods calling for a dry look or crisp surface after cooking should not be cooked using this feature. It is best to Time Cook them.



Auto Cook

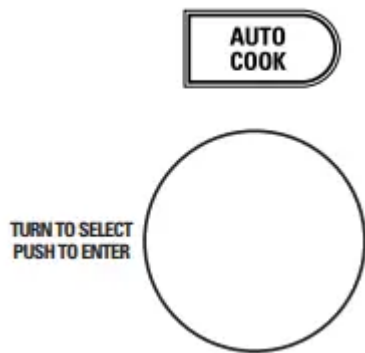

NOTE: Do not use this feature twice in succession on the same food portion—it may result in severely overcooked or burnt food.

1. Place covered food in the oven and close the door. Press the AUTO COOK button. SELECT FOOD TYPE appears in the display.
2. Turn the dial to the desired food type. Press to enter.

See the Sensor Food Type Guide below for specific foods and instructions.

The oven starts immediately.

NOTE: If the door was open while the control was being set, close the door and press the START/PAUSE button to begin cooking.

If food is undercooked after the countdown, use Time Cook for additional cooking time.

Do not open the oven door before the countdown time is displayed—steam escaping from the oven can affect cooking performance. If the door is opened, close the door and press START/PAUSE immediately.

If ground meat was selected, the oven may signal you to drain and stir the meat. Open the door, drain the meat and close the door. Press the START/PAUSE button if necessary to resume cooking.

Cooking Tips

- When oven signals and countdown time is displayed, the door may be opened for stirring, turning or rotating food. To resume cooking, close the door and press START/PAUSE.
- Match the amount of food to the size of container. Fill containers at least 1/2 full.
- Be sure outside of container and inside of oven are dry.
- After completion of Cook cycle, if food needs additional cooking, return food to oven and use Time Cook to finish cooking

How to Adjust the Oven's Automatic Settings for a Shorter or Longer Cook Time (Not available for all food types)

To subtract 10% from the automatic cooking time:

At any time after the countdown begins, turn the dial counterclockwise and press to enter.

To add 10% to the automatic cooking time: At any time after the countdown begins, turn the dial clockwise and press to enter.

Sensor Food Type Guide

Food Type	Servings	Serving Size	Comments
Chicken Pieces	1 to 4	2 to 8 pieces	Use oblong, square or round dish. Cover with vented plastic wrap.
Fish	1 to 4	4 to 16 oz.	Use oblong, square or round dish. Cover with vented plastic wrap.
Ground Meat (Beef, Pork, Turkey)	—	8 to 32 oz.	Use round casserole dish. Crumble meat into dish. Cover with vented plastic wrap.
Potatoes	1 to 4	8 to 32 oz.	Pierce skin with fork. Arrange in a star pattern in center of turntable.
Canned Vegetables	1 to 4	4 to 16 oz.	Use microwave-safe casserole or bowl. Cover with lid or vented plastic wrap.
Fresh Vegetables	1 to 4	4 to 16 oz.	Use microwave-safe casserole or bowl. Add 2 tablespoons water for each serving. Cover with lid or vented plastic wrap.
Frozen Vegetables	1 to 4	4 to 16 oz.	Use microwave-safe casserole or bowl. Follow package instructions for adding water. Cover with lid or vented plastic wrap.

Reheat



NOTE: Do not use this feature twice in succession on the same food portion—it may result in severely overcooked or burnt food.

The Reheat feature reheats servings of previously cooked foods or a plate of leftovers.

1. Place the cup of liquid or covered food in the oven. Press REHEAT once, twice or three times. The oven starts immediately.

Press once for a plate of leftovers.

Press twice for 1/2 to 1 full cup.

Press three times for 1 to 2 full cups.

2. The oven signals when steam is sensed and the time remaining begins counting down.

Do not open the oven door until time is counting down. If the door is opened, close it and press START immediately.

After removing food from the oven, stir, if possible, to even out the temperature. Reheated foods may have wide variations in temperature. Some areas of food may be extremely hot.

If food is not hot enough after the countdown use Time Cook for additional reheating time.

Some Foods Not Recommended for Use With Reheat

It is best to use Time Cook for these foods:

- Bread products.
- Foods that must be reheated uncovered.
- Foods that need to be stirred or rotated.
- Foods calling for a dry look or crisp surface after reheating.

How to Adjust the Oven's Automatic Settings for a Shorter or Longer Time

To subtract 10% from the automatic cooking time:

Within the first 30 seconds after the oven starts, turn the dial counterclockwise and press to enter.

To add 10% to the automatic cooking time: Within the first 30 seconds after the oven starts, turn the dial clockwise and press to enter.

Beverage



NOTE: Do not use this feature twice in succession on the same food portion—it may result in severely overcooked or burnt food.

Press the BEVERAGE button to heat an 8–10 oz. cup of coffee or other beverage. The oven starts immediately

Drinks heated with the Beverage feature may be very hot. Remove the container with care.

If food is undercooked after the countdown use Time Cook for additional cooking time.

Bake with Preheat

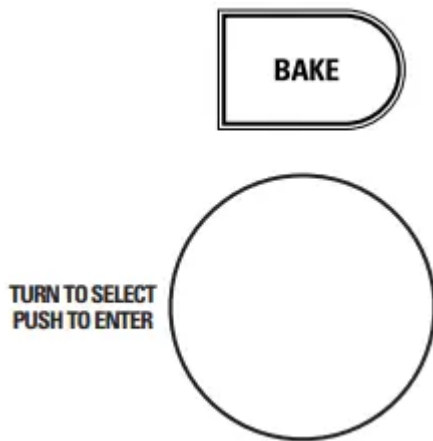

1. Press the BAKE button.
2. Turn the dial to set the oven temperature and press dial to enter. Do not enter bake time now. (The cook time will be entered later, after the oven is preheated.)
3. Press the dial or the START/PAUSE button to start preheating.
4. When the oven is preheated, it will signal. If you do not open the door within 1 hour, the oven will turn off automatically.
5. Open the oven door and, using caution, place the food in the oven.
6. Close the oven door. Turn the dial to set the cook time and press the dial or START/PAUSE to start cooking.
7. When cooking is complete, the oven will signal and turn off.

NOTE: You may change the cook time at any time during cooking by turning the dial.

You may change the oven temperature at any time during cooking by pressing the POWER button. Turn the dial to set the oven temperature and press the dial to enter.

To view the cook time and oven temperature during cooking, press the BAKE button.

Reduce the recipe oven temperature 25°F for baked goods.

Bake without Preheating

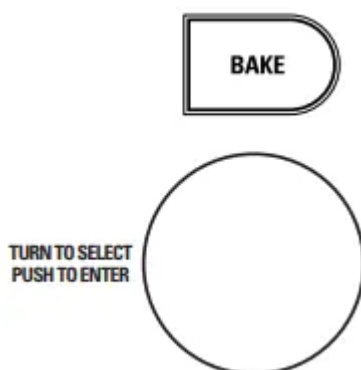

1. If your recipe does not require preheating, press the BAKE button.

2. Turn the dial to set the oven temperature and press to enter.
3. Turn the dial to set the cook time and press to enter.
4. Press the dial or the START/PAUSE button to start the oven.

NOTE: You may change the cook time at any time during cooking by turning the dial.

You may change the oven temperature at any time during cooking by pressing the POWER button. Turn the dial to set the oven temperature and press the dial to enter.

To view the cook time and oven temperature during cooking, press the BAKE button. Reduce the recipe oven temperature 25°F for baked goods.

Fast Bake with Preheat

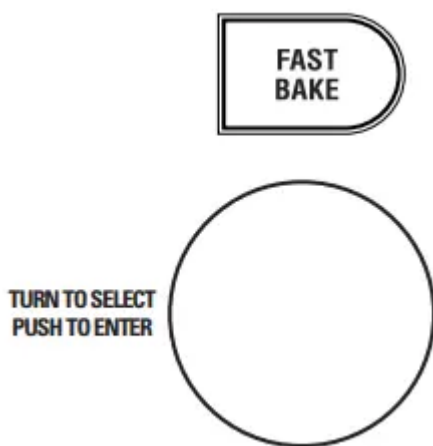

1. Press the FAST BAKE button.
2. Turn the dial to set the oven temperature and press dial to enter. Do not enter FAST BAKE cook time now. (The cook time will be entered later, after the oven is preheated.)
3. Press the dial or the START/PAUSE button to start preheating.
4. When the oven is preheated, it will signal. If you do not open the door within 1 hour, the oven will turn off automatically.
5. Open the oven door and, using caution, place the food in the oven.
6. Close the oven door. Turn the dial to set the cook time and press to enter. Press the dial or the START/PAUSE button to start cooking.
7. When cooking is complete, the oven will signal and turn off.

NOTE: You may change the cook time at any time during cooking by turning the dial.

You may change the oven temperature and microwave power level at any time during cooking by pressing the POWER button. Turn the dial to set the oven temperature and press the dial to enter. Then, turn the dial to set microwave power level 1 through 4 and press the dial to enter. The default power level is 4.

To view the cook time and oven temperature during cooking, press the FAST BAKE button.

- Check the Cookware Tips section for correct cookware when using Fast Bake.
- Do not use metal cookware with Fast Bake.
- Reduce the recipe cook time by 25%.
- See the Best Method of Cooking section to determine the which foods are appropriate to cook using Fast Bake.

Fast Bake without Preheat

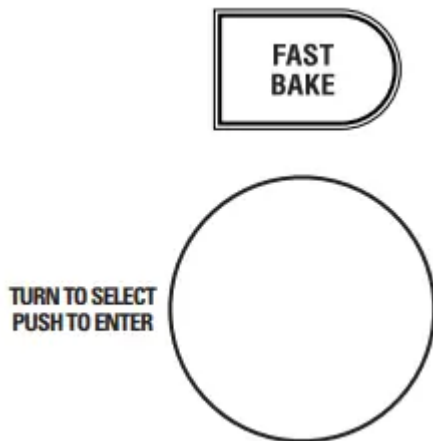

1. If your recipe does not require preheating, press the FAST BAKE button.
2. Turn the dial to set the oven temperature and press to enter.
3. Turn the dial to set the cook time and press to enter.
4. Press the dial or the START/PAUSE button to start the oven.

NOTE: You may change the cook time at any time during cooking by turning the dial.

You may change the oven temperature and microwave power level at any time during cooking by pressing the POWER button. Turn the dial to set the oven temperature and press the dial to enter. Then, turn the dial to set microwave power level 1 through 4 and press the dial to enter. The default power level is 4.

To view the cook time and oven temperature during cooking, press the FAST BAKE button.

NOTE:

- Some recipes call for preheating.
- Check the Cookware Tips section for correct cookware when using Fast Bake.
- Do not use metal cookware with Fast Bake.
- See the Best Method of Cooking section to determine the which foods are appropriate to cook using Fast Bake.
- Reduce the recipe cook time by 25%.

Bake

Metal Pans are recommended for all types of baked products, but especially where browning is important.

Dark or dull finish metal pans are best for breads and pies because they absorb heat and produce crisper crust.

Shiny aluminum pans are better for cakes, cookies or muffins because they reflect heat and help produce a light tender crust.

Glass or Glass-Ceramic casserole or baking dishes are best suited for egg and cheese recipes due to the cleanability of glass.

Fast Bake

Glass or Glass-Ceramic baking containers are recommended. Be sure not to use items with metal trim as it may cause arcing (sparking) with oven wall or oven shelf. This can damage the cookware, the shelf or the oven.

Heat-Resistant Plastic microwave cookware (safe to 450°F) may be used, but it is not recommended for foods requiring all-around browning, because the plastic is a poor conductor of heat.

Cookware	Microwave	Bake	Fast Bake
Heat-Resistant Glass, Glass-Ceramic (Pyrex®, Fire King®, Corning Ware®, etc.)	Yes	Yes	Yes
Metal	No	Yes	No
Non Heat-Resistant Glass	No	No	No
Microwave-Safe Plastics	Yes	No	Yes*
Plastic Films and Wraps	Yes	No	No
Paper Products	Yes	No	No
Straw, Wicker and Wood	Yes	No	No

* Use only microwave cookware that is safe to 450°F.

About the other features.

Help

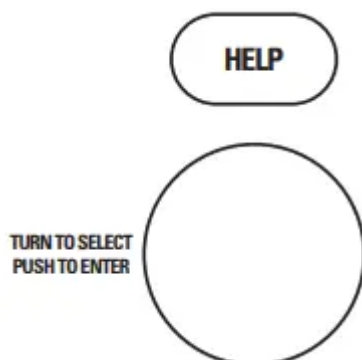

The HELP button displays feature information and helpful hints.

Press HELP, then turn the dial to select a feature and press the dial to enter.

Cooking Complete Reminder

To remind you that you have food in the oven, the oven will display YOUR FOOD IS READY and beep once a minute until you either open the oven door or press the CLEAR/OFF button.

Clock

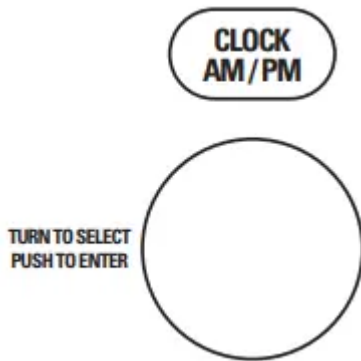

Press to enter the time of day or to check the time of day while cooking.

1. Press the CLOCK button.
2. Turn the dial to set hours. Press the dial to enter.
3. Turn the dial to set minutes. Press the dial to enter.
4. Turn the dial to select AM or PM. Press the dial to enter.
5. Press the START/PAUSE button to start the clock.

Start/Pause



In addition to starting many functions, START/PAUSE allows you to stop cooking without opening the door or clearing the display

Clear/Off



Press the CLEAR/OFF button to stop and cancel cooking at any time.

Child Lock-Out

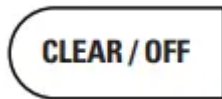

You may lock the control panel to prevent the oven from being accidentally started or used by children.

To lock or unlock the controls, press and hold the CLEAR/OFF button for about three seconds. When the control panel is locked, CONTROL LOCKED will be displayed briefly anytime a button or dial is pressed.

Auto Nite Light

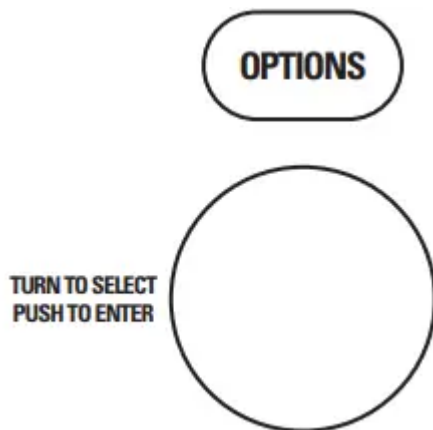

The Auto Nite Light can be set to come on and go off at desired times.

1. Press the OPTIONS button and turn the dial to select AUTO NITE LIGHT. Press the dial to enter.
2. Turn the dial to select SET TIMES. Press the dial to enter.
3. Enter the time of day for the light to come on by turning the dial to select the hour, minutes and AM or PM. Press the dial to enter after each selection.
4. Enter the time of day for the light to go off by turning the dial to select the hour, minutes and AM or PM. Press the dial to enter after each selection.

NOTE: The NITE indicator will be lit whenever the nite light is set to operate.

To review the nite light settings, turn the dial to select REVIEW SETTINGS after selecting the Auto Nite Light option. Press the dial to enter.

To clear the nite light settings, turn the dial to select CLEAR SETTINGS after selecting the Auto Nite Light option. Press the dial to enter.

Beeper Volume

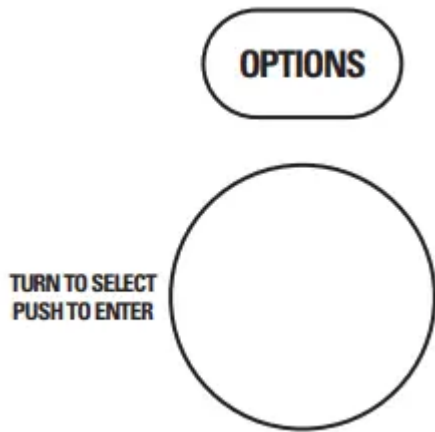

The beeper sound level can be adjusted.

1. Press the OPTIONS button and turn the dial to select BEEPER VOLUME. Press the dial to enter.
2. Turn the dial to select mute to loud. Press the dial to enter.

NOTE: The MUTE indicator will be lit whenever the beeper volume is set to mute.

Display Language

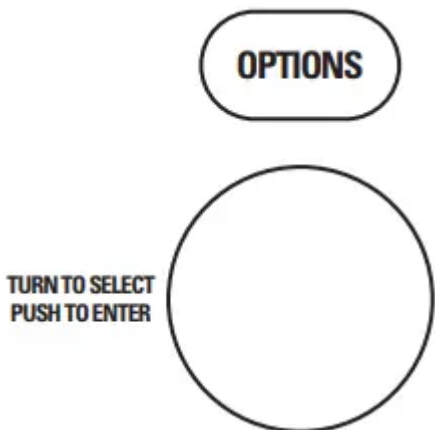

The language for the scrolling display can be set to either English or Spanish.

1. Press the OPTIONS button and turn the dial to select DISPLAY LANGUAGE. Press the dial to enter.
2. Turn the dial to select ENGLISH or SPANISH. Press the dial to enter.

Display ON/OFF

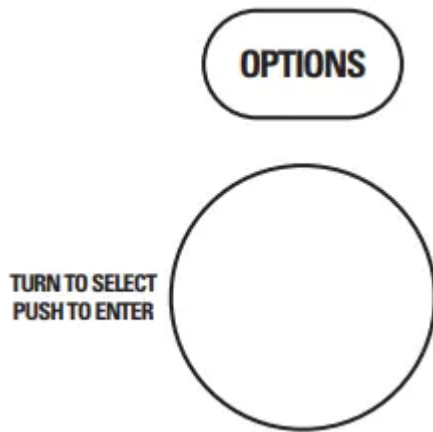

Use to turn your clock display on or off.

1. Press the OPTIONS button and turn the dial to select DISPLAY ON/ OFF. Press the dial to enter.
2. Turn the dial to select ON or OFF. Press the dial to enter.

Care and cleaning of the oven.

Helpful Hints



An occasional thorough wiping with a solution of baking soda and water keeps the inside fresh.

Be sure the power is off before cleaning any part of this oven.

How to Clean the Inside

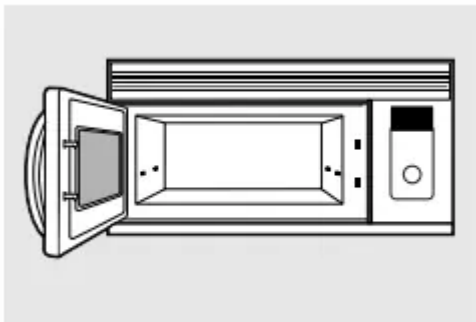

Walls, Floor, Inside Window, Metal and Plastic Parts on the Door

Some spatters can be removed with a paper towel; others may require a damp cloth. Remove greasy spatters with a sudsy cloth, then rinse with a damp cloth. Do not use abrasive cleaners or sharp utensils on oven walls.

Never use a commercial oven cleaner on any part of your microwave.

Removable Turntable and Turntable Support

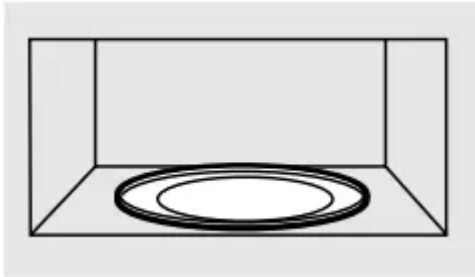

To prevent breakage, do not place the turntable into water just after cooking. Wash it carefully in warm, sudsy water or in the dishwasher. The turntable and support can be broken if dropped. Remember, do not operate the oven without the turntable and support in place.

Shelf

Clean with mild soap and water or in the dishwasher.

Do not clean in a self-cleaning oven.

How to Clean the Outside

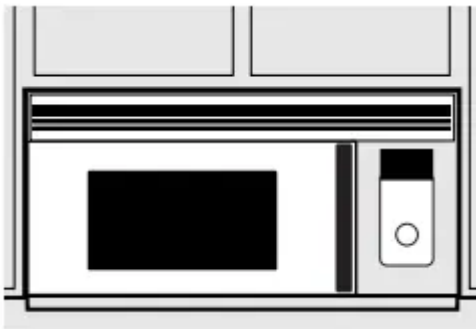

We recommend against using cleaners with ammonia or alcohol, as they can damage the appearance of the microwave oven. If you choose to use a common household cleaner, first apply the cleaner directly to a clean cloth, then wipe the soiled area.

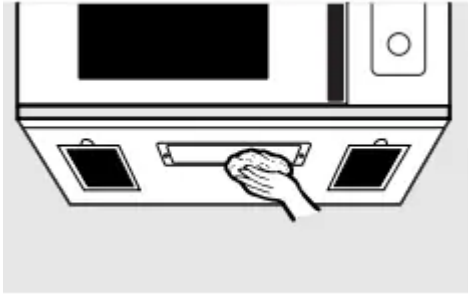

Case

Clean the outside of the microwave with a sudsy cloth. Rinse and then dry. Wipe the window clean with a damp cloth.

Control Panel

Wipe with a damp cloth. Dry thoroughly. Do not use cleaning sprays, large amounts of soap and water, abrasives or sharp objects on the panel—they can damage it. Some paper towels can also scratch the control panel.

Door Panel

Before cleaning the front door panel, make sure you know what type of panel you have. Refer to the eighth digit of the model number. “S” is stainless steel, “L” is CleanSteel and “B”, “W” or “C” are plastic colors.

Stainless Steel

The stainless steel panel can be cleaned with Stainless Steel Magic or a similar product using a clean, soft cloth. Apply stainless cleaner carefully to avoid the surrounding plastic parts. Do not use appliance wax, polish, bleach or products containing chlorine on Stainless Steel finishes.

CleanSteel

Use a clean, soft, light and lightly dampened cloth, then dry thoroughly. Do not use appliance wax, polish, bleach or products containing any chemical agent on the CleanSteel surfaces.

Plastic Color Panels

Use a clean, soft, lightly dampened cloth, then dry thoroughly.

Door Seal

It's important to keep the area clean where the door seals against the microwave. Use only mild, non-abrasive detergents applied with a clean sponge or soft cloth. Rinse well.

Bottom

Clean off the grease and dust on the bottom often. Use a solution of warm water and detergent.

Replacing the light bulb.

Cooktop Light/Nite Light

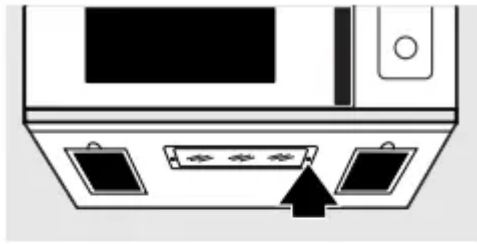

Remove screw.



Replace with a 130 volt, 35 watt (max.) halogen bulb. Order WB36X10213 from your GE supplier.

1. To replace the cooktop light/nite light, first disconnect the power at the main fuse or circuit breaker panel, or pull the plug.
2. Remove the screw from the side of the light compartment cover and lower the cover until it stops.
3. Be sure the bulb is cool before removing. Break the adhesive seal by gently unscrewing the bulb.
4. Screw in the new bulb, then raise the light cover and replace the screw. Connect electrical power to the oven.

About the exhaust feature.

Vent Fan

Charcoal filter (on some models).

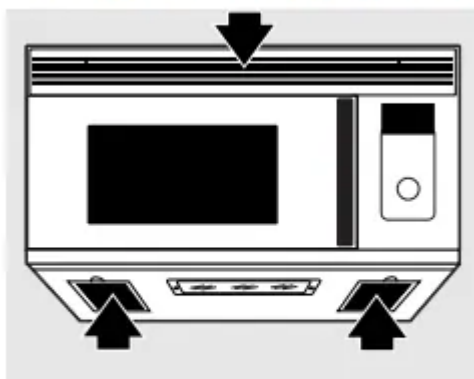

*Reusable vent filters
(on all models).*

The vent fan has two metal reusable vent filters.

Models that recirculate air back into the room also use a charcoal filter.

Reusable Vent Filters

The metal filters trap grease released by foods on the cooktop. They also prevent flames from foods on the cooktop from damaging the inside of the oven.

For this reason, the filters must always be in place when the hood is used. The vent filters should be cleaned once a month, or as needed.

Removing and Cleaning the Filters

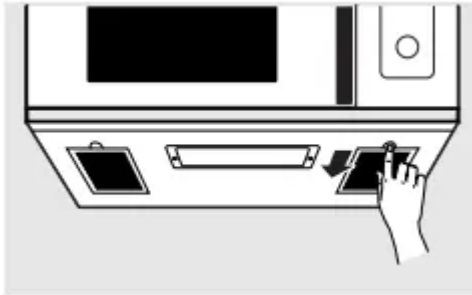

To remove, slide them to the rear using the tabs. Pull down and out.

To clean the vent filters, soak them and then swish around in hot water and detergent. Don't use ammonia or ammonia products because they will darken the metal. Light brushing can be used to remove embedded dirt.

Rinse, shake and let dry before replacing.

To replace, slide the filters into the frame slots on the back of each opening. Press up and to the front to lock into place.

Charcoal Filter

The charcoal filter cannot be cleaned. It must be replaced. Order Part No. WB2X9883 from your GE supplier.

If the model is not vented to the outside, the air will be recirculated through a disposable charcoal filter that helps remove smoke and odors.

The charcoal filter should be replaced when it is noticeably dirty or discolored (usually after 6 to 12 months, depending on usage). See "Optional Kits," page 7, for more information.

To Remove the Charcoal Filter

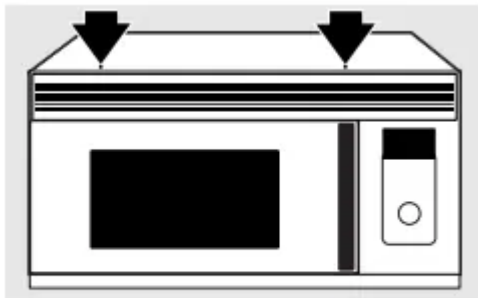

Remove 2 grille screws to remove the grille.

To remove the charcoal filter, first disconnect power at the main fuse or circuit breaker, or pull the plug. Remove the top grille by removing the two screws that hold it in place.

You may need to open the cabinet doors to remove the screws.

Slide the filter toward the front of the oven and remove it.

To Install the Charcoal Filter

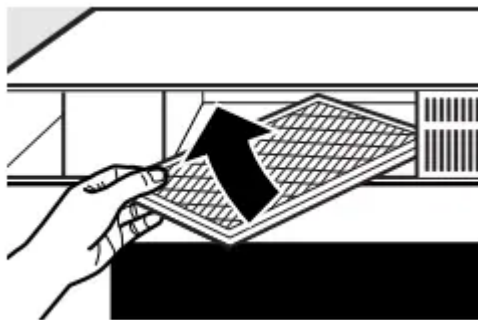

To install a new charcoal filter, remove plastic and other outer wrapping from the new filter.

Insert the filter into the top opening of the oven as shown, maneuvering it behind the plastic grille until it fits squarely into place. It will rest at an angle behind the plastic grille on two side support tabs and in front of the right rear tab. Replace the grille and two screws. Reconnect power.

Troubleshooting Tips

Problem	Possible Causes	What To Do
Oven will not start	A fuse in your home may be blown or the circuit breaker tripped.	• Replace fuse or reset circuit breaker.
	Power surge.	• Unplug the microwave oven, then plug it back in.
	Plug not fully inserted into wall outlet.	• Make sure the 3-prong plug on the oven is fully inserted into wall outlet.
	Door not securely closed.	• Open the door and close securely
Control panel lighted, yet oven will not start	Door not securely closed.	• Open the door and close securely
	START button not pressed after entering cooking selection.	• Press START
	Another selection entered already in oven and CLEAR/OFF button not pressed to cancel it.	• Press CLEAR/OFF
	Cooking time not entered after pressing TIME COOK	• Make sure you have entered cooking time after pressing TIME COOK.
	CLEAR/OFF was pressed accidentally.	• Reset cooking program and press START.
	Food weight not entered after selecting AUTO DEFROST or FAST DEFROST.	• Make sure you have entered food weight after selecting weight after selecting selecting UTO DEFROST or FAST DEFROST.
	Food type not entered after pressing AUTO COOK.	• Make sure you have entered a food type.

CONTROL LOCKED appears on display	The control has been locked.	<ul style="list-style-type: none"> • Press and hold CLEAR/OFF for about 3 seconds to unlock the control.
CAUTION—OVEN HOT appears on display	The temperature inside the oven is greater than 200°F.	<ul style="list-style-type: none"> • This is normal.
	One of the sensor cooking pads was pressed when the temperature inside the oven was greater than 200°F.	<ul style="list-style-type: none"> • These features will not operate when the oven is hot.
Floor of the oven is warm even when the oven has not been used	The cooktop light is located below the oven floor. When light is on, the heat it produces may make the oven floor get warm.	<ul style="list-style-type: none"> • This is normal.
You hear an unusual low-tone beep	You have tried to change the power level when it is not allowed.	<ul style="list-style-type: none"> • Many of the oven's features are preset and cannot be changed.
Oven emits a smoky odor and gray smoke after using the Bake feature	Oil on the stainless steel cavity is burning off after using the Bake feature the first few times.	<ul style="list-style-type: none"> • This is normal.
Food browns on top much faster than on the bottom	Rack has been placed in the "high" position.	<ul style="list-style-type: none"> • Always use the rack in its "low" position.
Oven temperature fluctuates during cooking	The cooking element cycles on and off to maintain the oven temperature at the desired setting.	<ul style="list-style-type: none"> • This is normal.
Vent fan comes on automatically	The vent fan automatically turns on to protect the microwave if it senses too much heat rising from the cooktop below.	<ul style="list-style-type: none"> • This is normal.
	During Bake or Fast Bake (after preheating), the vent	<ul style="list-style-type: none"> • This is normal.



fan will automatically come on to cool the oven components.

Things That Are Normal With Your Microwave Oven

- Moisture on the oven door and walls while cooking. Wipe the moisture off with a paper towel or soft cloth.
- Moisture between the oven door panels when cooking certain foods. Moisture should dissipate shortly after cooking is finished.
- Steam or vapor escaping from around the door.
- Light reflection around door or outer case.
- Dimming oven light and change in the blower sound at power levels other than high.
- Dull thumping sound while oven is operating.
- The vent fan operating while the microwave is operating. The vent fan will not go off nor can it be turned off until the microwave is off.
- TV-radio interference might be noticed while using the microwave. Similar to the interference caused by other small appliances, it does not indicate a problem with the microwave. Plug the microwave into a different electrical circuit, move the radio or TV as far away from the microwave as possible or check the position and signal of the TV/radio antenna.

Warning

This content is compiled from multiple sources and is provided for reference purposes only. It may not be complete or fully applicable to all situations. If you are unable to resolve your issue, please contact the product manufacturer or an authorized service provider for official support.