

USING THE DISHWASHER

Getting started

Features and appearance will vary throughout this manual

1. Load Dishwasher

For best dishwashing results, follow the loading guidelines found in the Loading section. No pre-rinsing of normal food soil is required. Scrape off hard soils, including bones, toothpicks, skins, and seeds. Remove leafy vegetables, meat trimmings, and excessive amounts of grease or oil.

2. Add Detergent

Add needed amount of detergent to the detergent dispenser. Use detergent such as **Finish® Quantum® Automatic Dishwashing Detergent**. See Dispensers section.

3. Add Rinse Agent

Add rinse agent such as Finish® Jet-Dry® Rinse Aid to the rinse agent dispenser. See Dispensers section.

NOTE: The use of rinse aid can further enhance the dishwasher's drying performance.

4. Select Cycle

Press the **Select Cycle** pad for the desired wash cycle. The light next to the Select Cycle pad will be lit to indicate which wash cycle has been selected.

NOTE: Cycle times vary based on soil level, water temperature, and options selected. The cycle may be selected with the door in the open position. The cycle will not start until the Start pad is pushed and the door is closed within 4 seconds.

AutoSense (on some models) This cycle automatically senses the soil level and adjusts the wash cycle accordingly. Time range: 1 hour 50 minutes - 2 hours 5 minutes.

Heavy This cycle is meant for heavily soiled dishes, cookware, pots, or pans with dried-on or baked-on soils. Everyday dishes are safe to be used in this cycle. *Time: 2 hours 30 minutes.

Normal This cycle is meant for daily, regular, or typical use to completely wash a full load of normally soiled dishes and is designed to conserve both water and energy. Normal was used to rate the energy efficiency of this dishwasher. *Time range: 1 hour 15 minutes - 1 hour 45 minutes.

1 Hour This cycle is for light to medium soiled dishes and takes about 1 hour. It is safe for china and crystal with no options selected. *Time: 50 minutes.

Rinse (on some models) For rinsing partial loads that will be washed later. Do not use detergent. Detergent is not dispensed during the rinse cycle. *Time: 15 minutes.

Washing time only. Does not include drying time, Auto Hot Start, or options. NOTE: If the incoming water temperature is too low, the Auto Hot Start feature may add up to 11 minutes of additional time.

5. Select Options

The light by the selected pad will be lit to indicate which Option has been selected.

Wash Temp Boost (on some models) This option increases the temperature to help clean heavily soiled dishes and will increase the cycle time by 20 to 50 minutes. Option may be turned On or Off during the wash cycle. This option will also improve dry performance on the Normal cycle.

Steam Sani (on some models) This option has several functions. Steam is introduced at the beginning of the cycle to help with heavily soiled and/or dried-on, baked-on soils and for sanitization of dishware along with improving dry performance by raising the water temperature in the final rinse. The cycle length will vary depending on the temperature of your inlet water. This option **MUST** be selected **PRIOR** to starting the cycle. Available with **Heavy, AutoSense and Normal cycles.**

NOTE: This option is monitored for sanitization requirements. If the cycle is interrupted during or after the main wash portion or if the incoming water temperature is so low that adequate water heating cannot be achieved, the sanitizing conditions may not be met. In these cases, the

Sanitized light will not illuminate at the end of the cycle. Utilizing this option will modify the cycle to meet the requirements of Section 6, NSF 184 for soil removal and sanitization efficacy.

NOTE: NSF certified residential dishwashers are not intended for licensed food establishments.

Heated Dry This option can be selected by pressing the **Dry** button once to illuminate the Heated light. This setting will greatly improve your dry performance for daily, regular or typical dishes. The heated dry option will typically add 48 minutes to your cycle time. This option is not available with the Rinse cycle. **NOTE:** The use of rinse aid can further enhance the dishwasher's drying performance. **Heated Dry** was selected to rate the energy efficiency of this dishwasher.

Dry Boost This option can be selected by pressing the Dry button twice to illuminate the Boost light. This option will add additional time to your heated dry option, further enhancing the dishwasher's drying performance for difficult to dry items. NOTE: The use of rinse aid can further enhance the dishwasher's drying performance.

Heated Dry Off Shuts off the drying option. Dishes air dry naturally and energy is saved. Opening the door at the end of the cycle can improve drying performance. NOTE: The use of rinse aid can further enhance the dishwasher's drying performance.

Bottle Jets (on some models) This option increases the time that the bottle jets are on and may add up to 23 minutes to the cycle time. Use this to wash difficult to clean, dishwasher safe baby bottles, sport bottles, tall coffee cups, etc. See use recommendations in the Loading section.

Wash Zones (on some models) Selecting either the Upper or Lower Wash Zones will target dishwashing of just one rack. This will shorten the cycle time and conserve energy. This option should be used when dishes are placed in only one rack.

Delay Hours (on some models) Delays the start of a wash cycle up to 8 to 12 hours depending on model. Press Delay Hours, to select the number of hours, then press Start one time and close door to begin countdown. The cycle will start once allotted time has expired.

Control Lock You can lock the controls to prevent selections from being made. You can also lock the controls after you have started a cycle to prevent cycle changes. For example, children cannot accidentally start the dishwasher by pressing pads with this option selected.

To LOCK/UNLOCK the dishwasher control, depending on the model, press and hold the Dry and **Steam** pads, or on some models the **Select Cycle** pad for 3 seconds. The Lock Controls light, or on some models the Light and Rinse cycle lights will

6. Start Dishwasher

Start Door can be open to select the desired options. Press the Start pad and close the door within seconds to start the cycle or begin the Delay Hours countdown. The wash cycle will begin shortly after closing the door. If the door is open, the illuminated lights will turn off if a pad is not pressed within two minutes. To activate the display, close and open the door or press any pad.

Interrupt or Pause To interrupt or pause a dish cycle, slowly open the door. Opening the door will cause the wash cycle to pause. The dishwasher will beep every minute to remind you to close the door. To restart or resume the cycle, press Start, and close the door within 4 seconds.

Cancel To cancel a wash cycle, press and hold the Start pad for 3 seconds and close door. The dishwasher will drain, emit a beep sound, and the wash cycle light will turn OFF.

7. Cycle Indicator Lights and Sounds

Sanitized Displayed at end of the cycle when Wash Temp Sani (Sanitize) has been selected and dishwasher has met requirements for sanitization. See Wash Temp Sani (Sanitize), for complete description. Opening the door or pressing any key while the door is closed will turn off the light.

Clean Displayed when a wash cycle is complete. The light stays ON as a reminder that the dishes are clean. Opening the door or pressing any key while the door is closed will turn the light off.

Sabbath/ Door Wake Up (Mode on some models) To turn this option ON/OFF, press and hold the Start and Wash Temp pads for 5 seconds, close the door and wait 3 minutes for the dishwasher to go into sleep mode. In the OFF mode, the control display, control sounds, and interior lights (on some models) will not respond to the door opening/closing. This mode can be used when observing certain religious holidays such as the Sabbath. To activate the control and interior lights (on some models), press any button.

Mute To turn the dishwasher control sounds ON/OFF, press the Heated Dry or Power Dry button 7 times within 5 seconds.

Dispensers

Check the Water Temperature

The entering water should be at least 120°F (49°C) and not more than 150°F (66°C) for effective cleaning and to prevent dish damage. Check the water temperature with a candy or meat thermometer.

Turn on the hot water faucet nearest the dishwasher, place the thermometer in a glass and let the water run continuously into the glass until the temperature stops rising.

Use a Rinse Agent

Rinse agents, such as Finish® Jet-Dry® Rinse Aid are designed for great drying action and to protect against spots and film build-up on your dishes, glasses, flatware, cookware, and plastic.

Filling the Rinse Agent Dispenser

The rinse agent dispenser holds 3.5 oz. (104 ml) of rinse agent. Under normal conditions, this will last approximately one month.

1. Make sure the dishwasher door is fully open.
2. Open the rinse agent dispenser door.
3. Slowly add rinse agent until the cup is full. You may need to pause several times to allow rinse aid to settle. **NOTE:** Indicator window does not light up.
4. Clean up any spilled rinse agent with a damp cloth to prevent foam from forming inside the dishwasher.
5. Close the rinse agent dispenser door.

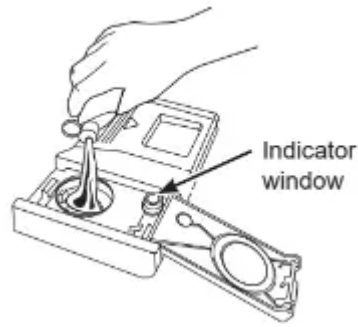

Rinse Aid Setting

The amount of rinse agent released into the final wash can be adjusted. If water drops or hard water spots remain on dishes after the dry cycle, increase the setting.



To adjust the setting

Open the Rinse Agent dispenser door; then turn the adjuster clockwise to increase the amount of rinse agent, counterclockwise to reduce the amount of rinse agent.

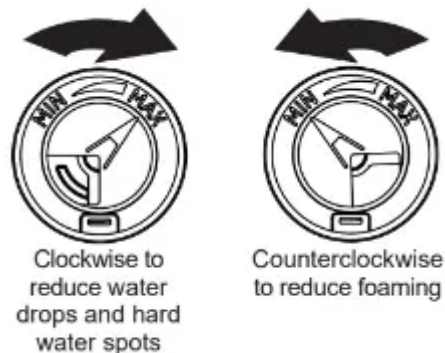

Detergent Dispenser

The detergent dispenser is located in the center of the dishwasher door. It has two compartments. The main wash compartment is found inside the detergent dispenser. To open, press the button on the side of the dispenser. The pre-wash compartment is on the lid of the detergent dispenser. Use the pre-wash compartment only when your water is extremely hard or when you have a heavy soiled load. The pre-wash compartment is not used when tablet or packet detergents are used.

NOTE: Do not block detergent dispenser with large or tall dishware.

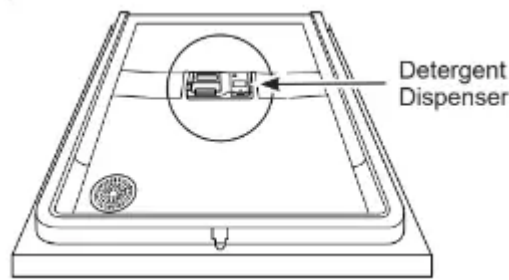

You may use tablet, packet, powder, liquid or gel automatic dishwasher detergent. Make sure you use only detergents specifically labeled for use in automatic dishwashers. Never use liquid hand dish detergent in an automatic dishwasher. Sudsing and poor wash performance will result with the use of improper detergents.

Detergents should be stored in a dry location and in their original container to prevent loss of effectiveness. Place detergent in the cup just prior to starting the dishwasher and then close the cover. The cover will open during the wash cycle.

Filling the Detergent Dispenser

GE Appliances recommends using detergent in tablet or packet form. Independent testing has shown this form of detergent is very effective in the dishwasher. Finish® Quantum® Powerball® is an example of this type of detergent. Simply put a tablet or packet into the main wash compartment and close the detergent cup cover. Please notice that the tablet or packet must be placed in the main wash compartment of the detergent cup. If the tablet or packet is placed in the prewash compartment or tossed in the bottom of the dishwasher, the detergent will be flushed down the drain in a very short period of time and will thus be wasted. Wash performance will be very poor as a result.

If you choose to use detergent in powder, liquid or gel form, the amount of detergent you use will be determined by the hardness of your water, the temperature of your water, and the food soil load inside the dishwasher. Contact your water company to get information about the hardness of the water in your area. Water hardness is measured in grains per gallon. Use this information and the table above to determine the amount of detergent to use. You may purchase a hard water test strip from GE Appliances. Call 877-959-8688 and ask for part number WD01X10295. In Canada, call 800-661-1616.

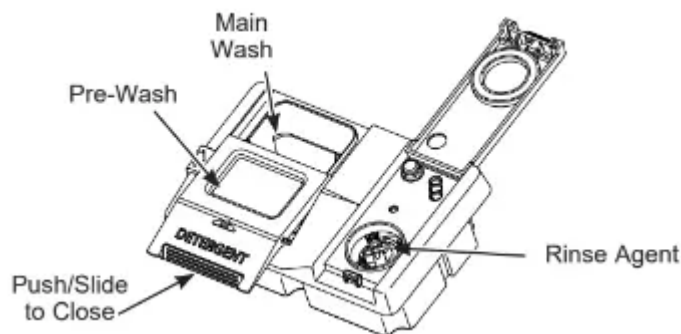

Use the table as a starting point and then adjust the amount of detergent you use. Use just enough to get good wash performance. Using just the right amount of detergent will provide great wash performance without wasting detergent or etching glassware.

Number of Grains/Gal.	Detergent Cup(s) to Fill
Less than 4	Fill cup to 1/3 full
4 to 8	Fill cup to 2/3 full
8 to 12	Fill cup completely full
Greater than 12	Fill both main wash cup and pre wash cup

Using too much detergent with very soft and/or very hot water may cause a condition called etching on your glassware. Etching is a permanent cloudiness in your glassware. This condition is irreversible. However, using too little detergent will cause poor wash performance.

DO NOT USE HAND DISH DETERGENT

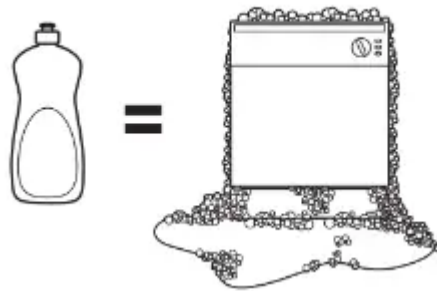

NOTE: Using a detergent that is not specifically designed for dishwashers will cause the dishwasher to fill with suds.

During operation, these suds will spill out of the dishwasher vents, covering the kitchen floor and making the floor wet.

Because so many detergent containers look alike, store the dishwasher detergent in a separate space from all other cleaners. Show anyone who may use the dishwasher the correct detergent and where it is stored.

While there will be no lasting damage to the dishwasher, your dishes will not get clean using a dishwashing detergent that is not formulated for automatic dishwashers.

Loading

For best dishwashing results, follow these loading guidelines. Features and appearance of racks and silverware baskets may vary from your model.

Upper Rack

The upper rack is primarily for glasses, cups, and saucers. For best wash performance, tilt cup and glass openings toward the center of the rack. Other items such as pots, pans, and plates may be placed in the upper rack. This is also a secure place for dishwasher-safe plastic items. The upper rack can be used for odd sized utensils. Sauce pans, mixing bowls, and other similarly shaped items should be placed face down for best wash performance. Ensure small plastic items are secure so that they cannot fall on the heater at the bottom of the dishwasher, potentially damaging the item.

IMPORTANT: Ensure items in the upper rack do not interfere with the 3rd Rack (on some models) when loading and unloading.

IMPORTANT: Ensure that items do not protrude through the bottom of the rack or silverware basket where they will block the rotation of the middle spray arm. This could result in noise during operation and/or poor wash performance.

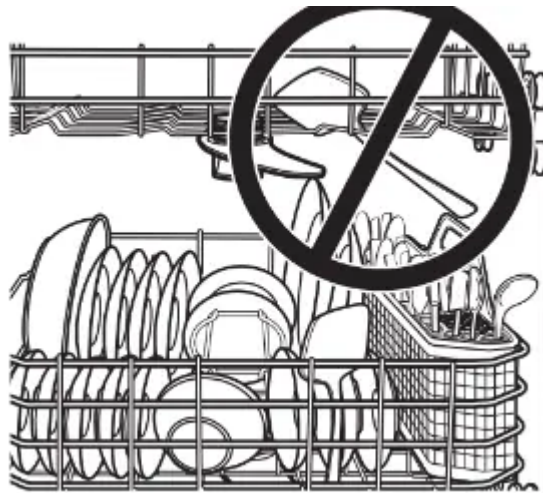

CAUTION: A loaded upper rack may be heavier than anticipated. To prevent minor injury or damage to the contents, do not raise or lower the upper rack after the rack is loaded.

On some models, the upper rack may be adjusted to accommodate larger items. To adjust the upper rack, fully extend the upper rack and lift the front of the rack so that the rack roller wheels clear the end hooks on the front of the rails. Continue to pull the rack until the remaining rack roller wheels clear the end hook. Select the set of rollers on the side of the rack that provides the desired height, and reinstall the upper rack by aligning the rack roller wheels on the end hook and rack rails – Ensure that there are roller wheels above and below the rack rails. Failure to properly align the wheels onto the end hook and rails may result in the rack falling from the dishwasher.

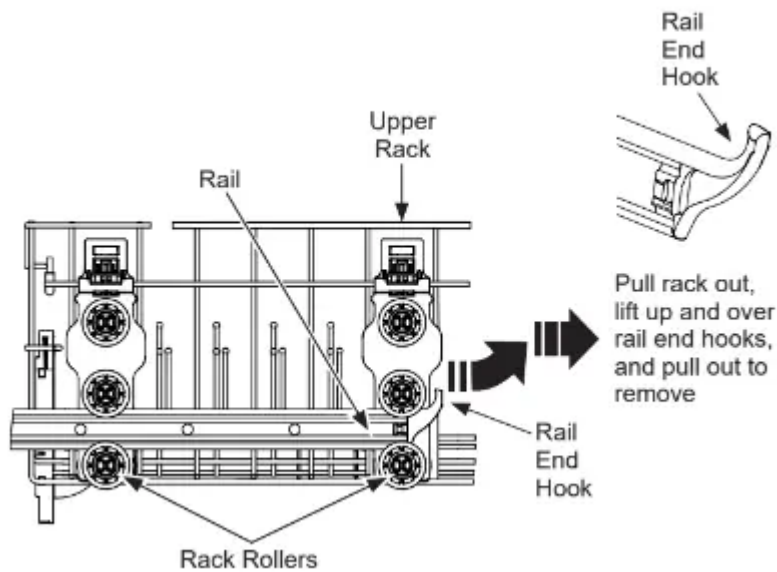

To add flexibility in loading, the stem safe shelf (on some models) may be placed in the up or down position or unfolded and placed in the lower unfolded position.

The shelf may also be used to secure stemware such as wine glasses. Because these stemware items come in various sizes, slowly push the rack in to ensure the items do not bump into the edges of the dishwasher, which may cause damage to the items.

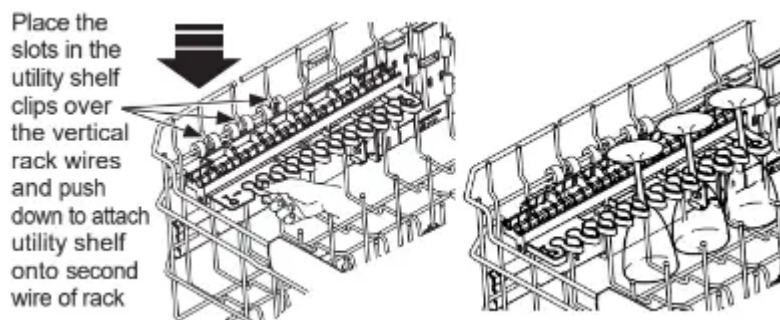

The **Bottle Jets** system (on some models) is the ideal location to position baby bottles, tall sports bottles, or other tall items with narrow openings. The **Bottle Jets** clips hold bottles with small openings in place so water jets are directed inside the bottles to clean hard to reach areas. Clips can be installed or removed by simply slipping the clip opening over the top of the nozzle.

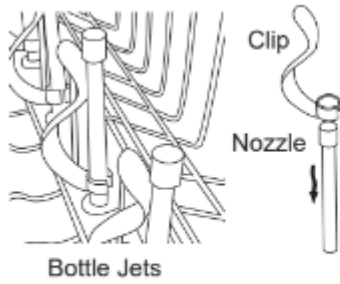

Bottle Jets

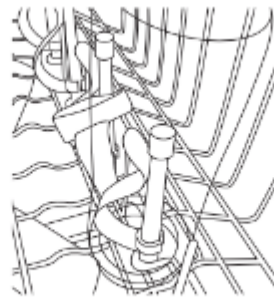

Sports bottle held in place over a Bottle Jets clip

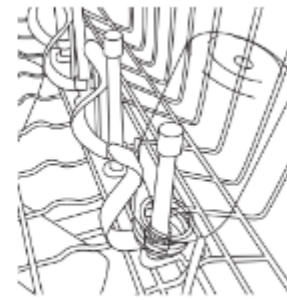

Baby bottle held in place under a Bottle Jets clip

For best dishwashing results, follow these loading guidelines. Features and appearance of racks and silverware baskets may vary from your model.

Upper Rack - 8 Place Settings
GDF510, GDF511, GDT535



Upper Rack - 10 Place Settings
GDF510, GDF511, GDT535



Upper Rack - 12 Place Settings
GDF510, GDF511, GDT535



Upper Rack - 8 Place Settings
GDF530, GDT605, GDP615, GDT635



Upper Rack - 10 Place Settings
GDF530, GDT605, GDP615, GDT635



Upper Rack - 12 Place Settings
GDF530, GDT605, GDP615, GDT635



Upper Rack - 8 Place Settings
GDF630 & GDF640

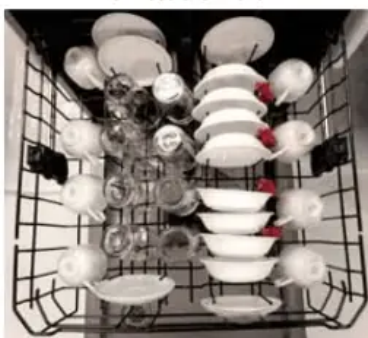

Upper Rack - 10 Place Settings
GDF630 & GDF640



Upper Rack - 12 Place Settings
GDF630 & GDF640



Lower Rack

The lower rack is best used for plates, saucers and cookware items. Large items, such as broiler pans and baking racks should be placed along the sides of the rack.



If necessary, oversized glasses and mugs can be placed in the lower rack to maximize loading flexibility. Plates, saucers and similar items should be placed between the tines in the direction that allows the item to remain secure in the rack.

IMPORTANT: It is important to ensure that items do not protrude through the bottom of the rack or the silverware basket where they will block the rotation of the lower spray arm. This could result in noise during operation and/or poor wash performance.

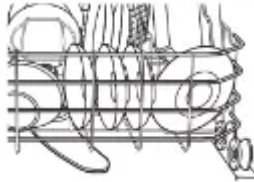

Lower Rack - 8 Place Settings
GDF510, GDF511, GDF530, GDT535,
GDT605, GDP615, GDT635



Lower Rack - 10 Place Settings
GDF510, GDF511, GDF530, GDT535,
GDT605, GDP615, GDT635



Lower Rack - 12 Place Settings
GDF510, GDF511, GDF530, GDT535,
GDT605, GDP615, GDT635

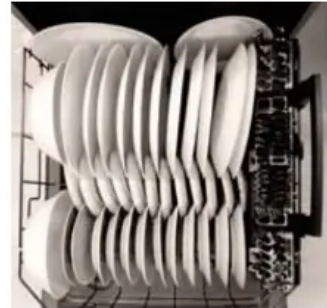

Lower Rack - 8 Place Settings
GDF630* & GDF640*



Lower Rack - 10 Place Settings
GDF630* & GDF640*



Lower Rack - 12 Place Settings
GDF630 & GDF640

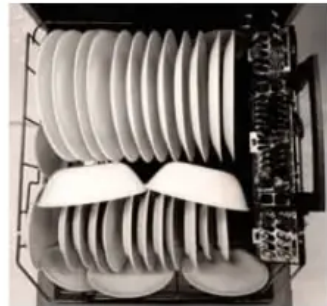

*See the 3rd Rack in this Loading section, for 8 Place Settings and 10 Place Settings, of silverware.

3rd Rack (GDF630 & GDF640)

CAUTION: Take care when loading, unloading, or transporting the silverware or utensil tray. The tray may contain sharp or heavy items. If items are dropped from the tray or the tray is dropped, injury could occur.

IMPORTANT NOTES:

- Do not allow cutlery of different materials to touch each other in the 3rd rack. Doing so may cause discoloration of the cutlery.
- The tray is only meant to be used with a GE Appliances 3rd rack dishwasher to hold silverware, cooking utensils, and other small items. Using the tray for any other

purpose could result in damage to the tray or damage to anything interacting with the tray.

- Ensure that the 3rd rack is fully closed before shutting the dishwasher door. Shutting the door with the rack partially extended could cause damage to the dishwasher.

8 Place Settings



10 Place Settings



12 Place Settings



The 3rd rack is also removable to allow extra large items to be placed in the upper rack:

To remove the 3rd rack:

1. With the rack fully extended, lift the front of the rack so that the rack roller wheels clear the end hook.
2. Continue to pull the rack until the remaining rack roller wheels clear the end hook.
3. Replace the rack by aligning the rack roller wheels on the end hook and rack rails – Ensure all roller wheels are located on top of the rack rails.

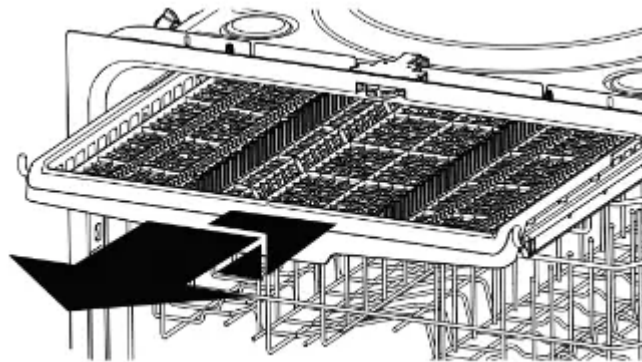

Silverware Basket

Place flatware in the removable silverware basket. Sharp objects, such as forks and knives, may be placed with the handles facing up, in order to protect your hands. For the best wash performance, place other items such as spoons with the handles facing down. Avoid allowing items to nest together, which may keep them from being properly washed. When loading, distribute items evenly in the basket.

The silverware basket may also be used for small items, such as measuring spoons, baby bottle nipples, plastic lids, or corn cob holders. The silverware basket covers on some models) can be closed to contain small items.



IMPORTANT: Do not load large or tall utensils where they may block the detergent dispenser, mid spray arm, or become trapped between the door and the gasket when the door is closed.

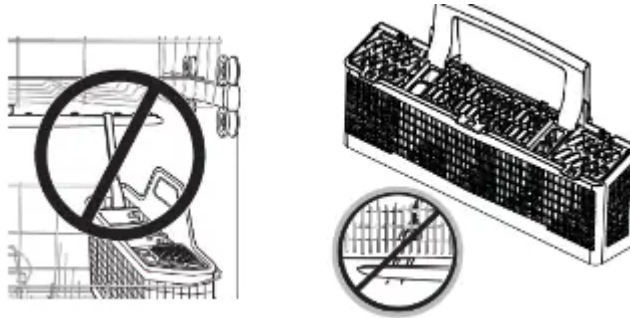

Silverware Basket - 8 Place Settings
GDF510, GDF511, GDF530, GDT535,
GDT605, GDP615, GDT635



Silverware Basket - 10 Place Settings
GDF510, GDF511, GDF530, GDT535,
GDT605, GDP615, GDT635



Silverware Basket - 12 Place Settings
GDF510, GDF511, GDF530, GDT535,
GDT605, GDP615, GDT635, GDF630*, GDF640*



*See the 3rd Rack in this Loading section, for 8 Place Settings and 10 Place Settings, of silverware.

CARE AND CLEANING

Control Panel

To clean the control panel, use a lightly dampened cloth. The dry thoroughly

Exterior Door Panel

Before cleaning the front panel, make sure you know what type of panel you have. Refer to the last two letters of your model number. You can locate your model number on the left-hand tub wall just inside the door. If your model number ends with BB, CC, WW, SA, ES, DS, TS or FS then you have a painted door panel. If your model number ends with SS, then you have a Stainless Steel door panel. If your model number ends with II, then you have an Integrated door panel.

Follow the instructions below for cleaning the door panel for your specific model.

Painted/Coated Door Panels (model numbers ending in BB–black, CC–bisque, WW–white, SA–silver, ES–slate, DS–black slate, TS–black stainless steel or FS–fingerprint resistant stainless steel)

WARNING: DO NOT use Stainless Steel cleaners on the door surfaces.

Use a clean, soft, lightly dampened cloth, then dry thoroughly.

Do not use scouring pads or powered cleaners because these products can scratch the finish.

Stainless Steel Door Panel (model numbers ending in SS)

For cleaning rust and tarnish, cleaners with oxalic acid such as Bar Keepers Friend Soft Cleanser™ will remove rust, tarnish and small blemishes. Use only a liquid cleanser free of grit and rub in the direction of the brush lines with a damp soft sponge. Do not use appliance wax or polish on the stainless steel.

For other blemishes and marks, use Stainless Steel Magic or a similar product using a clean soft cloth. Do not use appliance wax, polish, bleach or products containing chlorine on Stainless Steel. You can order Stainless Steel Magic # WX10X29 through GE Appliances Parts by calling 877.959.8688. In Canada, call 800-661-1616.

Integrated Door Panel (model numbers ending in II)

This is a custom installed door panel, and you will need to refer to the cabinet manufacturers recommendations for proper cleaning.

Dishwasher Interior

To clean and de-odorize your dishwasher, use citric acid or **Finish® Dishwasher Cleaner**, a detergent additive. **Finish® Dishwasher Cleaner** will break up mineral deposits, and remove hard water film and stains. You can order citric acid GE Appliances kit # WD35X151 through GE Appliances Parts by calling 877-959-8688 or visiting GEApplianceparts.com. In Canada, call 800-661-1616. You can purchase **Finish® Dishwasher Cleaner** at your local grocery store.

Stainless Steel Inner Door and Tub

The stainless steel used to make the dishwasher tub and inner door provides the highest reliability available in a GE Appliances dishwasher.

If the dishwasher tub or inner door should be scratched or dented during normal use, they will not rust or corrode. These surface blemishes will not affect their function or durability.

Filters

Inspect and clean the filters periodically. This should be done every other month or more depending on usage. If there is a decrease in wash performance or dishes feel gritty, this is also an indication the filters need to be cleaned.

WARNING: The retaining posts can be a choke hazard for small children if removed from the dishwasher. Keep out of reach of children.

Ultra-Fine Filter

To clean the Ultra-Fine Filter, remove the bottom rack. Twist the Ultra-Fine Filter counterclockwise and lift to remove. Rinse filter with warm soapy water and use a sponge to carefully remove any stubborn particles. Scrubbing with scouring pads or brushes can

damage the filter. Once cleaned, replace the Ultra-Fine Filter, and twist it clockwise to lock in place.

Fine Filter

To clean the Fine Filter (mesh plate), remove the bottom rack. Remove the Ultra-Fine Filter. Twist each of the two retaining posts located toward the back bottom of the tub counterclockwise, and remove the Fine Filter. Rinse filter with warm soapy water. Scouring pads or brushes can scratch the filter surface but a soft brush or sponge may be needed to remove stubborn soils or calcium deposits caused by hard water. Once cleaned, replace the Fine Filter and the Ultra-Fine Filter. Twist the two retaining posts clockwise to lock in place.

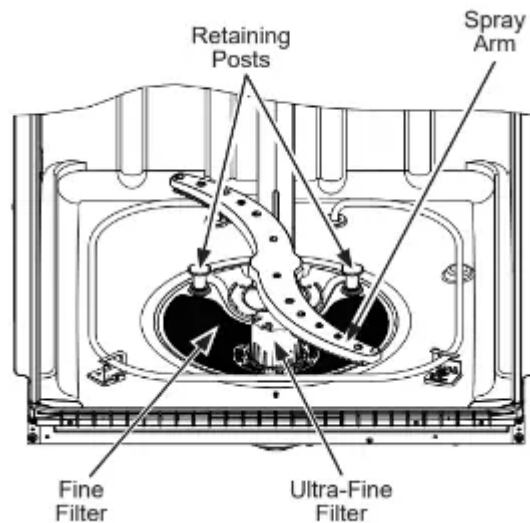

Protect Against Freezing

If your dishwasher is left in an unheated place during the winter, ask a service technician to:

1. Turn off electrical power to the dishwasher. Remove fuses or trip circuit breaker.
2. Turn off the water supply and disconnect the water inlet line from the water valve.
3. Drain water from the water inlet line and water valve. (Use a pan to catch the water.)
4. Reconnect the water inlet line to the water valve.

Does Your Dishwasher Have an Air Gap?

An air gap protects your dishwasher against water backing up into it if a drain clogs. The air gap is not a part of the dishwasher. It is not covered by your warranty. Not all plumbing codes require air gaps, so you may not have one.



The air gap is easy to clean.

1. Turn off the dishwasher and lift off the air gap cover.
2. Remove the plastic cap under the cover and clean with a toothpick.
3. Replace the cap and cover when the air gap is clean.

Troubleshooting Tips... Before you call for service

Start status indicator light flashing

- **The door was opened or the cycle was interrupted.**
 - Press the Start pad once and close the door within 4 seconds to start the dishwasher. Press the Start pad a second time when the dishwasher is running only if you wish to cancel the cycle.

Dishwasher BEEPS once every minute on some models)

- **This is a reminder that your dishwasher door has been left open during operation. It will continue beeping until you press Start and close the door.**
 - Press Start and close the door.

Beeping at the end of the cycle (on some models)

- **This is normal. Dishwasher will beep twice at the end of the cycle.**
 - To turn off the double beep indicator (or re-activate it if it was previously turned off), press the Heated Dry pad 5 times within 3 seconds. A triple beep will sound to indicate the end-of-cycle beep option has been turned on or off.

Dishes and flatware not clean

- **Ultra-Fine Filter or Fine Filter is clogged**
 - See the Care and Cleaning section.
- **Low inlet water temperature**
 - Make sure inlet water temperature is correct (see the **USING THE DISHWASHER** section). Turn on the hot water faucet nearest the dishwasher, let run until the water temperature stops rising. Then start the dishwasher and turn off the faucet. This

ensures the entering water is hot. Select **Wash Temp Boost** if available.

- **Water pressure is temporarily low**

- Turn on a faucet. Is water coming out more slowly than usual? If so, wait until pressure is normal before using your dishwasher. Normal water pressure to the dishwasher should be 20-120 psi.

- **Air gap or disposer clogged**

- Clean the air gap or flush the disposer.

- **High drain loop or air gap not installed**

- Refer to the Installation Instructions for proper drain line installation.

- **Improper rack loading**

- Make sure large dishware does not block the detergent dispenser or the wash arms. See the Loading section.

- **Poor performing detergent**

- Use a highly rated detergent such as **Finish® Quantum® Automatic Dishwashing Detergent**.

Spots and filming on glasses and flatware

- **Extremely hard water**

- Use rinse agents such as Finish® Jet-Dry® Rinse Aid to prevent spots and prevent new film build-up. If water is extremely hard, a softener may be required.

- **Low inlet water temperature**

- Make sure water temperature is at least 120°F (49°C).

- **Overloading or improper loading of the dishwasher**

- Load dishwasher as shown in the Loading section.

- **Old or damp powder detergent**

- Make sure detergent is fresh. Use a highly rated detergent such as Finish® Quantum® Automatic Dishwashing Detergent.

- **Rinse agent dispenser empty**

- Refill with rinse agent such as Finish® Jet-Dry® Rinse Aid.

- **Too little or low performing detergent**

- Make sure you use the proper amount of highly rated detergent.

Cloudiness on glassware

- **Combination of soft water and too much detergent**
 - This is called etching and is permanent. To prevent this from happening, use less detergent if you have soft water. Wash glassware in the shortest cycle that will get it clean.
- **Low performing phosphate- free detergent**
 - See A white film on glassware, dishware and the interior in this TROUBLESHOOTING section.
- **Water temperature entering the dishwasher exceeds 150°F (66°C)**
 - This could be etching. Lower the water heater temperature.

Suds in the tub

- **Wrong detergent**
 - Use only automatic dishwasher detergents to avoid sudsing. Finish® Quantum® Automatic Dishwashing Detergent has been approved for use in all GE Appliances dishwashers. To remove suds from the tub, open the dishwasher and let suds dissipate. Pump out water by pressing Start and close the door. Wait 30 seconds. Open the door, press and hold Start for 3 seconds, and close the door. Repeat if necessary.
- **Rinse agent was spilled**
 - Always wipe up rinse agent spills immediately.

Detergent left in dispenser cups

- **Dishes are blocking the detergent cup**
 - Reposition the dishes, so the water from the lower spray arm can flush the detergent cup. See the Loading section. Reposition dishware that may be keeping the dispenser cup door from opening. See the Loading section.

Black or gray marks on dishes

- **Aluminum utensils have rubbed against dishes**
 - Remove marks with a mild, abrasive cleaner.

Dishes don't dry

- **Low inlet water temperature**
 - Make sure inlet water temperature is at least 120°F. Select Heated Dry or Dry Boost. Use Wash Temp Boost. Select a higher cycle, such as Steam Sani or Heavy.
- **Rinse agent dispenser is empty**
 - Check the rinse agent dispenser and fill as required.
- **Additional drying time is needed**
 - Leave door closed after the Clean light appears to allow the fan to run an additional 90 minutes (on some models). **Note:** If you open the door, this fan extension will be cancelled.
- **Cycle selection**
 - If using Light cycle which uses lower water temperature and thus limited dry performance, switch to a different cycle.
- **Cycle completion**
 - Allow cycles to fully complete. See Long cycle times in this Troubleshooting Tips section

Long cycle times

- **Dishwasher washes by alternating mid and lower spray arms**
 - Longer cycles are normal. For best wash and dry performance, let cycle complete.
- **Soil level**
 - The turbidity sensor senses how much soil is on the dishes. Heavy soiled dish loads will add more time to the cycle. This is normal function. For best wash and dry performance, allow cycle to complete.

Control panel responded to inputs but dishwasher never filled with water

- **Door may not be completely closed**
 - Make sure the door is firmly closed.
- **Water valve may be turned off**
 - Make sure water valve (usually located under the sink) is turned on.

- **Flood float may be stuck**

- Remove Ultra-Fine filter and lightly tap the piece under the ultra fine filter that looks like a dome. Replace the filter.

Stained tub interior

- **Some tomato-based foods can cause reddish stains**

- Use of the Steam Sani cycle (on some models) after adding the dish to the load can decrease the level of staining.

- **Tea or coffee stains**

- Remove the stain by hand, using a solution of 1/2 cup bleach and 3 cups warm water. **NOTE:** Do not use bleach on stainless steel inner door. **CAUTION: Before cleaning interior, wait at least 20 minutes after a cycle for the heating elements to cool down. Failure to do so can result in burns.**

- **An overall yellow or brown film can be caused by iron deposits in water**

- A special filter in the water supply line is the only way to correct this problem. Contact a water softener company.

- **White film on inside surface— hard water minerals**

- GE Appliances recommends Finish® Jet-Dry® Rinse Aid to help prevent hard water mineral deposits from forming. Run dishwasher with citric acid to remove mineral deposits. Citric acid (Part number: WD35X151) can be ordered through GE Appliances Parts. See back cover for ordering information. Alternatively, purchase **Finish® Dishwasher Cleaner** and follow the directions on the label.

Dishwasher won't run

- **Fuse is blown or circuit breaker is tripped**

- Replace fuse or reset circuit breaker. Remove any other appliances from the circuit.

- **Power is turned off**

- In some installations, the power to the dishwasher is provided through a wall switch, often located next to the disposer switch. Make sure it is on.

- **Control panel is locked**

- Unlock control panel. See the Getting started section.

Control panel lights go off when you're setting controls

- **Time too long between touching of selected buttons**
 - Each pad must be touched within 30 seconds of the others. To relight, touch any pad again or open the door and unlock (top control).

Water standing in the bottom of the tub

- **Air gap is clogged**
 - Clean the air gap. See the Care and Cleaning section.
- **High drain loop or air gap not installed**
 - Refer to the Installation Instructions for proper drain line installation.

Water won't pump out of the tub

- **Drain is clogged**
 - If you have an air gap, clean it. See the Care and Cleaning section. If the dishwasher drains into a disposer, run disposer clear. Check to see if your kitchen sink is draining well. If not, you may need a plumber.

Steam

- **This is normal**
 - Warm, moist air comes through the vent during drying and when water is being pumped out. This is necessary for drying.

Sanitized light does not illuminate at the end of the cycle

- **The door was opened and the cycle was interrupted during final rinse**
 - Do not interrupt the cycle by opening the door during the wash cycle.
- **The incoming water temperature was too low**
 - Raise the water heater temperature to between 120°F and 150°F.

Noise

- **Normal operating sounds: Beeping at the end of the cycle (on some models) . Detergent cup opening. Water entering dishwasher. Motor stops and starts at various times during cycle. Spray arms start and stop at**

various times. Drain pump sounds during pump out. Drain pump starts and stops several times during each drain

- These are all normal. No action is required.

Rattling dishes when the spray arm rotates

Make sure dishes are properly loaded. See the Loading section.

Rattling silverware against door during wash

Tall utensils may be placed in the upper rack to avoid bumping against inner door during wash cycle.

A white film on glassware, dishware and the interior

- **This problem is likely caused by a low quality phosphate-free dishwasher detergent**
 - To remove the white film, run your dishes through a dishwasher cycle with citric acid. Use a WD35X151 citric acid kit found online. Otherwise, use Finish® Dishwasher Cleaner found at your local grocery store. Pour the citric acid in the detergent cup and close the cover. Place the filmed but otherwise clean glassware and dishware in the dishwasher. Leave silverware and other metal items out of the dishwasher. Turn the dishwasher on and let it run through a complete cycle without detergent. The glassware, dishware, and dishwasher should come out film free. Alternatively, a vinegar rinse may be used. Pour 1 cup of vinegar into dishwasher just after the detergent cup opens and let the dishwasher complete its cycle. This may be repeated several times a year as needed. The use of a rinse agent such as Finish® Jet-Dry® Rinse Aid may help minimize a repeat build up of film. Also, the use of a highly rated detergent such as Finish® Quantum® Automatic Dishwashing Detergent will help prevent film build-up.

Warning

This content is compiled from multiple sources and is provided for reference purposes only. It may not be complete or fully applicable to all situations. If you are unable to resolve your issue, please contact the product manufacturer or an authorized service provider for official support.

