

## Operating Instructions

### Using the gas surface burners

Throughout this manual, features and appearance may vary from your model.

#### Before Lighting a Gas Burner

- Drip pans are supplied with your range; they should be used at all times.
- Make sure all burners are in place.
- Make sure all grates on the range are properly placed before using any burner.

#### After Lighting a Gas Burner

- Do not operate the burner for an extended period of time without cookware on the grate. The finish on the grate may chip without cookware to absorb the heat.
- Be sure the burners and grates are cool before you place your hand, a pot holder, cleaning cloths or other materials on them.

#### How to Light a Gas Surface Burner



Push the control knob in and turn it to the LITE position.

Make sure all the surface burners are placed in their respective positions.

Push the control knob in and turn it to the LITE position. You will hear a little clicking noise— the sound of the electric spark igniting the burner.

Turn the knob to adjust the flame size. If the knob stays at LITE, it will continue to click.

When one burner is turned to LITE, all the burners spark. Do not attempt to disassemble or clean around any burner while another burner is on. An electric shock may result, which could cause you to knock over hot cookware.

### Sealed Gas Burners

Your gas range cooktop has four sealed gas burners. They offer convenience and flexibility to be used in a wide range of cooking applications.

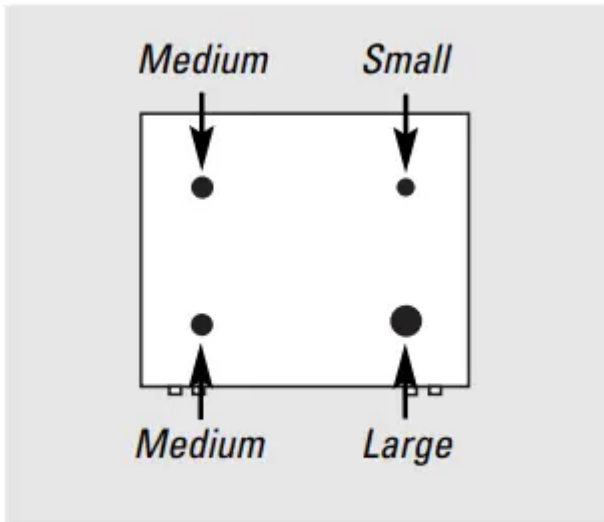

*On some models*

The smallest burner in the right rear position is the simmer burner. This burner can be turned down to a very low simmer setting. It provides precise cooking performance for delicate foods such as sauces or foods that require low heat for a long cooking time.

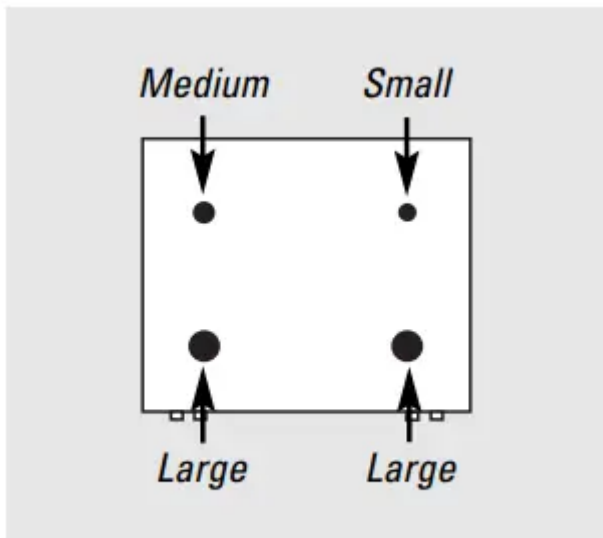

*On some models*



The medium (left rear and, on some models, left front) and the large (right front and, on some models, left front) burners are the primary burners for most cooking. These general-purpose burners can be turned down from HI to LO to suit a wide range of cooking needs.

**NOTE:** On some models, the burners are all the same size and power.

### How to Select Flame Size



*For safe handling of cookware, never let the flames extend up the sides of the cookware.*

Watch the flame, not the knob, as you reduce heat. When fast heating is desired, the flame size on a gas burner should match the cookware you are using.

Flames larger than the bottom of the cookware will not result in faster heating of the cookware and could be hazardous.

### Top-of-Range Cookware

**Aluminum:** Medium-weight cookware is recommended because it heats quickly and evenly. Most foods brown evenly in an aluminum skillet. Use saucepans with tightfitting lids when cooking with minimum amounts of water.

**Cast-Iron:** If heated slowly, most skillets will give satisfactory results.

**Enamelware:** Under some conditions, the enamel of some cookware may melt. Follow cookware manufacturer's recommendations for cooking methods.

**Glass:** There are two types of glass cookware—those for oven use only and those for top-of-range cooking (saucepans, coffee and teapots). Glass conducts heat very slowly.

**Heatproof Glass Ceramic:** Can be used for either surface or oven cooking. It conducts heat very slowly and cools very slowly. Check cookware manufacturer's directions to be sure it can be used on gas ranges.

**Stainless Steel:** This metal alone has poor heating properties and is usually combined with copper, aluminum or other metals for improved heat distribution. Combination metal skillets usually work satisfactorily if they are used with medium heat as the manufacturer recommends.

### Stove Top Grills (on models with sealed burners)

Do not use stove top grills on your sealed gas burners. If you use the stove top grill on the sealed gas burner, it will cause incomplete combustion and can result in exposure to carbon monoxide levels above allowable current standards.

This can be hazardous to your health.



### **Wok This Way (on models with sealed burners)**

We recommend that you use a 14" or smaller flat-bottomed wok. Make sure the wok bottom sits flat on the grate. They are available at your local retail store.

Only a flat-bottomed wok should be used.



*Use a flat-bottomed wok.*

Do not use a flat-bottomed wok on a support ring. Placing the ring over the burner or grate may cause the burner to work improperly, resulting in carbon monoxide levels above allowable standards. This could be dangerous to your health.



## In Case of Power Failure

In case of a power failure, you can light the gas surface burners on your range with a match. Hold a lit match to the burner, then push in and turn the control knob to the LITE position. Use extreme caution when lighting burners this way.

Surface burners in use when an electrical power failure occurs will continue to operate normally.

## Using the oven controls



### Oven Control, Clock and Timer Features and Settings (on some models)

#### 1. Bake/Temp Recall Pad

- Touch this pad to select the bake function.
- Bake Light
  - Flashes while in edit mode—you can change the oven temperature at this point. Glows when the oven is in bake mode.

#### 2. Start/On Pad

- Must be touched to start any cooking or cleaning function.

#### 3. Display

- Shows the time of day, oven temperature, whether the oven is in the bake, broil or self-cleaning mode and the times set for the timer or automatic oven operations. The display will show PRE while preheating. When the oven reaches the selected temperature, the oven control will beep and the display will show the oven temperature.
- If “F— and a number or letter” flash in the display and the oven control signals, this indicates a function error code.
- If your oven was set for a timed oven operation and a power outage occurred, the clock and all programmed functions must be reset.

- The time of day will flash in the display when there has been a power outage. Reset the clock.
- If the function error code appears during the self-cleaning cycle, check the oven door latch. The latch handle may have been moved, even if only slightly, from the latched position. Make sure the latch is moved to the right as far as it will go.
- Touch the Clear/Off pad. Allow the oven to cool for one hour. Put the oven back into operation. If the function error code repeats, disconnect the power to the range and call for service.

#### 4. Kitchen Timer On/Off Pad

- Touch this pad to select the timer feature. Then press the + and – pads to adjust the timer.
- Timer Light
  - Flashes while in edit mode—you can change the set time at this point. Glows when the timer has been activated. Flashes again when the time has run out until the control is reset.

#### 5. Clock Pad

- To set the clock, press this pad twice and then press the + and – pads. The time of day will flash in the display when the oven is first turned on.

#### 6. Start Time Pad (on some models)

- Use along with the Cooking Time or Self Clean pads to set the oven to start and stop automatically at a time you set.
- Start Time Light
  - Flashes while in edit mode—you can change the start time at this point. Glows when the function has been activated.

#### 7. Cooking Time Pad (on some models)

- Touch this pad and then touch the + or – pads to set the amount of time you want your food to cook. The oven will shut off when the cooking time has run out.
- Cooking Time Light
  - Flashes while in edit mode—you can change the set time at this point. Glows when the function has been activated. Flashes again when the time has run out until the control is reset.

## 8. Automatic Oven Light (on some models)

- This lights anytime the oven has been programmed using the Cooking Time or Start Time functions.

## 9. Oven Light On/Off Pad Touch this pad to turn the oven light on or off.

## 10. – Pad

- Short taps to this pad will decrease the time or temperature by small amounts. Touch and hold the pad to decrease the time or temperature by larger amounts.

## 11. + Pad

- Short taps to this pad will increase the time or temperature by small amounts. Touch and hold the pad to increase the time or temperature by larger amounts.

## 12. Self Clean Pad

- Touch this pad to select the self-cleaning function. See the Using the self-cleaning oven section.
  - Clean Light
    - Flashes while in edit mode—you can change the length of time for the self-clean cycle at this point. Glows when the oven is in the self-clean cycle. After the self-clean cycle, the light will turn off. Unlatch the door.

## 13. Clear/Off Pad

- Touch this pad to cancel ALL oven operations except the clock and timer.

## 14. Broil Hi/Lo Pad

- Touch this pad to select the broil function.
  - Broil Light
    - Flashes while in edit mode—you can switch from Hi to Lo Broil at this point. Glows when the oven is in broil mode.
  - Indicator Lights (on some pads)
    - EDIT mode lasts several seconds after the last pad press. Start Time and Cooking Time will be the only pads lit if either of these options is selected. (Example: Start Time is selected with Bake—the Start Time pad will remain lit until the clock reaches the programmed time, at which point it will turn off and the Bake/Temp Recall pad light will light up).

### Oven Temperature Knob (on some models)

Turn the OVEN TEMP knob to the setting you want.

- The oven cycling light comes on during cooking.



*Appearance may vary.*

### Using the oven

To avoid possible burns, place the shelves in the desired position before you turn the oven on.

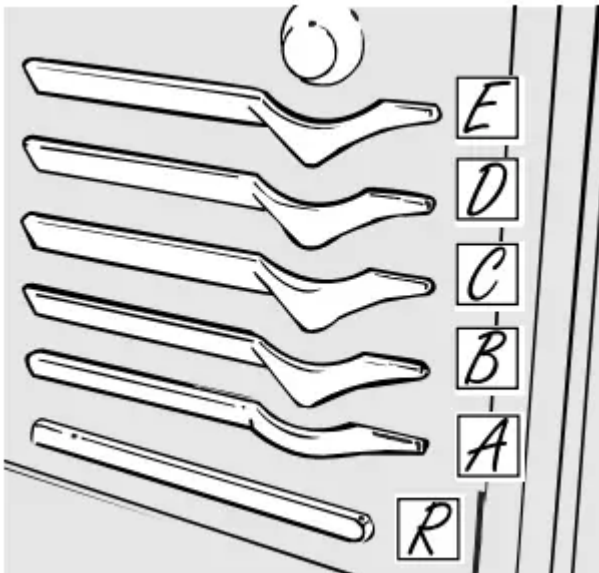

*The oven has 5 shelf positions.*

*It also has a special low shelf position (R) for extra large items, such as a large turkey.*

**Before you begin...**

The shelves have stop-locks, so that when placed correctly on the shelf supports (A through E), they will stop before coming completely out, and will not tilt.

When placing and removing cookware, pull the shelf out to the bump on the shelf support.

To remove a shelf, pull it toward you, tilt the front end up and pull it out.

To replace, place the end of the shelf (stop-locks) on the support, tilt up the front and push the shelf in.

**NOTE:** The shelf is not designed to slide out at the special low shelf (R) position.

### Oven Vent



*Plastic items on the cooktop may melt if left too close to the vent.*

*Vent appearance and location vary*

Your oven is vented through ducts at the rear of the range. Do not block these ducts when cooking in the oven—it is important that the flow of hot air from the oven and fresh air to the oven burner be uninterrupted. Avoid touching the vent openings or nearby surfaces during oven or broiler operation—they may become hot.

- Handles of pots and pans on the cooktop may become hot if left too close to the vent.
- Do not leave plastic or flammable items on the cooktop—they may melt or ignite if left too close to the vent.
- Do not leave closed containers on the cooktop. The pressure in closed containers may increase, which may cause them to burst.
- Metal items will become very hot if they are left on the cooktop, and could cause burns.

### Power Outage

**CAUTION:** Do not make any attempt to operate the electric ignition oven during an electrical power failure.

The oven or broiler cannot be lit during a power failure. Gas will not flow unless the glow bar is hot.

If the oven is in use when a power failure occurs, the oven burner shuts off and cannot be re-lit until power is restored. This is because the flow of gas is automatically stopped and will not resume when power is restored until the glow bar has reached operating temperature.

### Oven Light (on some models)

Touch the Oven Light On/Off pad on the upper control panel to turn the light on or off.

### Oven Light (on some models)

Press the Oven Light On/Off pad on the lower control panel to turn the light on or off.

Do not lock the oven door with the latch during baking or roasting. The latch is used for self-cleaning only.

### How to Set the Oven for Baking or Roasting

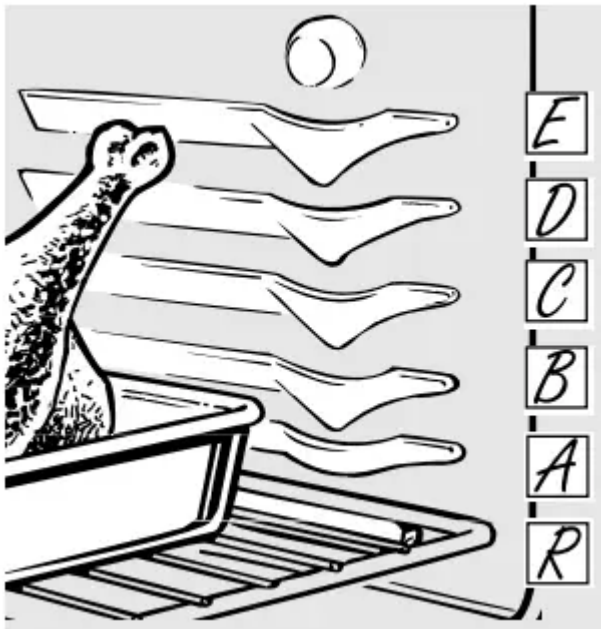

*The oven has a special low shelf (R) position just above the oven bottom. Use it when extra cooking space is needed, for example, when cooking a large turkey. The shelf is not designed to slide out at this position.*

Your oven is not designed for open-door cooking.

**NOTE:** On models with an OVEN TEMP knob, turn it to the desired temperature.

1. Touch the Bake pad.
2. Touch the + or – pads until the desired temperature is displayed.
3. Touch the Start/On pad.

The oven will start automatically. The display will show PRE while preheating. When the oven reaches the selected temperature, the oven control will beep several times and the display will show the oven temperature.

To change the oven temperature during BAKE cycle, touch the Bake pad and then the + or – pads to get the new temperature.

4. Check food for doneness at minimum time on recipe. Cook longer if necessary.
5. Touch the Clear/Off pad when baking is finished and then remove the food from the oven.

<b>Type of Food</b>	<b>Shelf Position</b>
Frozen pies (on cookie sheet)	B or C
Angel food cake, bundt or pound cakes	B
Biscuits, muffins, brownies, cookies, cupcakes, layer cakes, pies	C
Casseroles	B or C
Roasting	R or A

### **Preheating and Pan Placement**

Preheat the oven if the recipe calls for it. To preheat, set the oven at the correct temperature. Preheating is necessary for good results when baking cakes, cookies, pastry and breads.

For ovens without a preheat indicator light or tone, preheat 10 minutes.

Baking results will be better if baking pans are centered in the oven as much as possible. Pans should not touch each other or the walls of the oven. If you need to use two shelves, stagger the pans so one is not directly above the other, and leave approximately 1 1/2" between pans, from the front, back and sides of the wall.

### **Aluminum Foil**

Do not use aluminum foil on the bottom of the oven.

Never entirely cover a shelf with aluminum foil. This will disturb the heat circulation and result in poor baking.

A smaller sheet of foil may be used to catch a spillover by placing it on a lower shelf several inches below the food.

### **Oven Moisture**

As your oven heats up, the temperature change of the air in the oven may cause water droplets to form on the door glass. These droplets are harmless and will evaporate as the oven continues to heat up.

## How to Set the Oven for Broiling

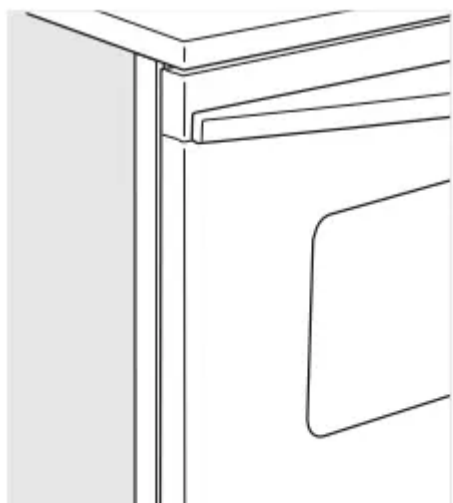

***Close the door. Always broil with the door closed.***

**NOTE:** On models with an OVEN TEMP knob, turn it to BROIL.

1. Place the meat or fish on a broiler grid in a broiler pan.
2. Follow suggested shelf positions in the Broiling Guide.
3. The oven door must be closed during broiling.
4. Touch the Broil Hi/Lo pad once for Hi Broil.
  - To change to Lo Broil, touch the Broil Hi/Lo pad again.
5. Touch the Start/On pad.
6. When broiling is finished, touch the Clear/Off pad.

Serve the food immediately, and leave the pan outside the oven to cool during the meal for easiest cleaning.

Use Lo Broil to cook foods such as poultry or thick cuts of meat thoroughly without over-browning them.

### Broiling Guide

The size, weight, thickness, starting temperature and your preference of doneness will affect broiling times. This guide is based on meats at refrigerator temperature.

*†The U.S. Department of Agriculture says “Rare beef is popular, but you should know that cooking it to only 140°F means some food poisoning organisms may survive.” (Source: Safe Food Book, Your Kitchen Guide, USDA Rev. June 1985.)*



*The oven has 5 shelf positions.*

<b>Food</b>	<b>Quantity and/ or Thickness</b>	<b>Shelf* Position</b>	<b>First Side Time (min.)</b>	<b>Second Side Time (min.)</b>	<b>Comments</b>
<b>Bacon</b>	1/2 lb. (about 8 thin slices)	C	4	3	Arrange in single layer.
<b>Ground Beef</b> Well Done	1 lb. (4 patties) 1/2 to 3/4" thick	C	10	7-10	Space evenly. Up to 8 patties take about the same time.
<b>Beef Steaks</b> Rare <sup>1</sup> Medium Well Done	1" thick 1 to 1½ lbs.	C C C	9 12 13	7 5-6 8-9	Steaks less than 1" thick cook through before browning. Pan frying is recommended. Slash fat.
Rare <sup>1</sup> Medium Well Done	1½" thick 2 to 2½ lbs.	C C C	10 12-15 25	6-7 10-12 16-18	
<b>Chicken</b>	1 whole 2 to 2½ lbs., split lengthwise 4 bone-in breasts	B B	30-35 25-30	15-20 10-15	
<b>Lobster Tails</b>	2-4 6 to 8 oz. each	C	13-16	Do not turn over.	Cut through back of shell. Spread open. Brush with melted butter before broiling and after half of broiling time.
<b>Fish Fillets</b>	1/4 to 1/2" thick	D	6	6	Handle and turn very carefully. Brush with lemon butter before and during cooking, if desired. Preheat broiler to increase browning.
<b>Ham Slices</b> (precooked)	1" thick 1/2" thick	C D	8 6	8 6	
<b>Pork Chops</b> Well Done	2 (1/2" thick) 2 (1" thick) about 1 lb.	D D	10 15	8 8	Slash fat.
<b>Lamb Chops</b> Medium Well Done	2 (1" thick) about 10 to 12 oz.	D D	8 10	4-7 10	Slash fat.
Medium Well Done	2 (1½" thick) about 1 lb.	D D	10 17	4-6 12-14	

*\*See illustration for description of shelf positions.*

## Using the clock and timer. (on some models)

Not all features are on all models.

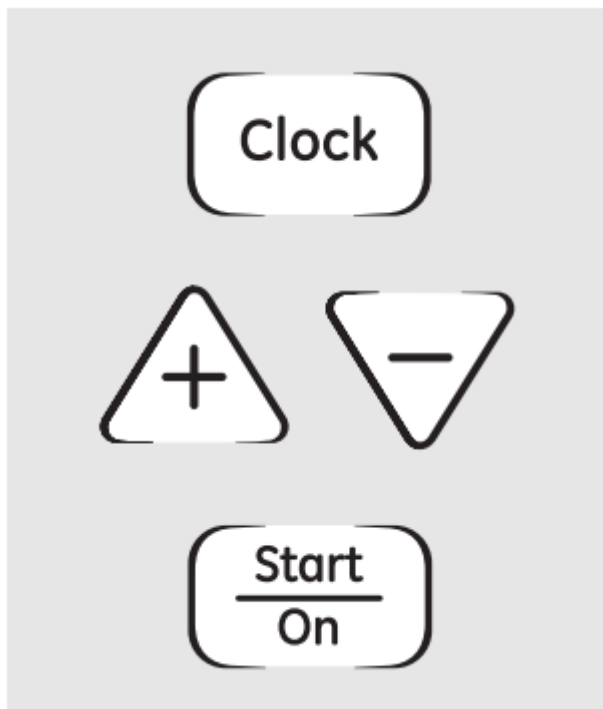

*Make sure the clock is set to the correct time of day*

The clock must be set to the correct time of day for the automatic oven timing functions to work properly. The time of day cannot be changed during a delayed cooking or a delayed self-cleaning cycle.

1. Touch the Clock pad twice.
2. Touch the + or – pads.
  - If the + or – pads are not touched within one minute after you touch the Clock pad, the display reverts to the original setting. If this happens, touch the Clock pad twice and reenter the time of day
3. Touch the Start/On pad until the time of day shows in the display. This enters the time and starts the clock.

To check the time of day when the display is showing other information, simply touch the Clock pad. The time of day shows until another pad is touched.

### **To Turn Off the Clock Display**

If you have several clocks in your kitchen, you may wish to turn off the time of day clock display on your range.

1. Touch the Clock pad once to turn off the time of day display. Although you will not be able to see it, the clock maintains the correct time of day.

2. Touch the Clock pad twice to recall the clock display

### To Set the Timer



*The timer is a minute timer only.*

*The Clear/Off pad does not affect the timer*

The timer does not control oven operations. The maximum setting on the timer is 9 hours and 59 minutes.

1. Touch the Kitchen Timer On/Off pad.
2. Touch the + or – pads until the amount of time you want shows in the display. The maximum time that can be entered in minutes is 59. Times more than 59 minutes should be changed to hours and minutes.
  - If you make a mistake, touch the Kitchen Timer On/Off pad and begin again.
3. Touch the Start/On pad. The time will start counting down, although the display does not change until one minute has passed.
4. When the timer reaches **:00**, the control will beep 3 times followed by one beep every 6 seconds until the Kitchen Timer On/Off pad is touched.

### To Reset the Timer

If the display is still showing the time remaining, you may change it by touching the Kitchen Timer On/Off pad, then touch the + or – pads until the time you want appears in the display.

If the remaining time is not in the display (clock, start time or cooking time are in the display), recall the remaining time by touching the Kitchen Timer On/Off pad and then touching the + or – pads to enter the new time you want.

#### **To Cancel the Timer**

Touch the Kitchen Timer On/Off pad twice.

#### **End of Cycle Tones (on some models)**

Clear the tones by pressing the pad of the function you are using



#### **Power Outage**

If a flashing time is in the display, you have experienced a power failure. Reset the clock.

To reset the clock, touch the Clock pad. Enter the correct time of day by touching the + or – pads. Touch the Start/On pad.

#### **Using the timed baking and roasting features. (on some models)**

Do not lock the oven door with the latch during timed cooking. The latch is used for self-cleaning only.

**NOTE:** Foods that spoil easily—such as milk, eggs, fish, stuffings, poultry and pork—should not be allowed to sit for more than 1 hour before or after cooking. Room temperature promotes the growth of harmful bacteria. Be sure that the oven light is off because heat from the bulb will speed harmful bacteria growth.

#### **How to Set an Immediate Start and Automatic Stop**



The oven will turn on immediately and cook for a selected length of time. At the end of the cooking time, the oven will turn off automatically

1. Touch the Bake pad.
2. Touch the + or – pads to set the oven temperature.
3. Touch the Cooking Time pad.

**NOTE:** If your recipe requires preheating, you may need to add additional time to the length of the cooking time.

4. Touch the + or – pads to set the baking time

The cooking time that you entered will be displayed. (If you select Cooking Time first and then adjust the Bake Temperature, the oven temperature will be displayed instead).

5. Touch the Start/On pad.

The display shows either the oven temperature that you set or the cooking time countdown. (The display starts with PRE if showing the oven temperature.)

The oven will continue to cook for the programmed amount of time, then turn off automatically.

6. Touch the Clear/Off pad to clear the display if necessary.

Remove the food from the oven. Remember, even though the oven shuts off automatically, foods continue cooking after controls are off.

### **How to Set a Delayed Start and Automatic Stop**

The oven will turn on at the time of day you set, cook for a specific length of time and then turn off automatically



Make sure the clock shows the correct time of day.

1. Touch the Bake pad.
2. Touch the + or – pads to set the oven temperature.
3. Touch the Cooking Time pad.

4. Touch the + or – pads to set the desired length of cooking time.
5. Touch the Start Time pad.
6. Touch the + or – pads to set the time of day you want the oven to turn on and start cooking.
7. Touch the Start/On pad.

**NOTE:** An attention tone will sound if you are using timed baking and do not touch the Start/On pad.

**NOTE:** If you would like to check the times you have set, touch the Start Time pad to check the start time you have set or touch the Cooking Time pad to check the length of cooking time you have set.

When the oven turns on at the time of day you have set, the display will show PRE until it reaches the selected temperature, then it will display the oven temperature.

At the end of cooking time, the oven will turn off and the end of cycle tone will sound.

8. Touch the Clear/Off pad to clear the display if necessary.

Remove the food from the oven. Remember, even though the oven shuts off automatically, foods continue cooking after controls are off

### **Special features of your oven control. (on some models)**

*Your new touch pad control has additional features that you may choose to use.*

*The following are the features and how you may activate them. The special feature modes can only be activated while the display is showing the time of day. They remain in the control's memory until the steps are repeated.*

*When the display shows your choice, touch the Start/On pad. The special features will remain in memory after a power failure.*

**NOTE:** *The Sabbath feature and the Thermostat Adjustment feature are also Special Features, but they are addressed separately in the following sections.*

### **12 Hour Shut-Off**



*With this feature, should you forget and leave the oven on, the control will automatically turn off the oven after 12 hours during baking functions or after 3 hours during a broil function.*

If you wish to turn OFF this feature, follow the steps below.

1. Touch the Bake and Broil Hi/Lo pads at the same time for 3 seconds until the display shows SF. Touch the Clock pad. The display will show ON (12 hour shut-off).
2. Touch the Clock pad repeatedly until the display shows OFF (no shut-off).
3. Touch the Start/On pad to activate the no shut-off and leave the control set in this special features mode.

### **Adjust the oven thermostat—Do it yourself!**

You may find that your new oven cooks differently than the one it replaced. Use your new oven for a few weeks to become more familiar with it. If you still think your new oven is too hot or too cold, you can adjust the thermostat yourself.

Do not use thermometers, such as those found in grocery stores, to check the temperature setting of your oven. These thermometers may vary 20–40 degrees.

**NOTE:** This adjustment will not affect the broiling or the self-cleaning temperatures. The adjustment will be retained in memory after a power failure.

#### **To Adjust the Thermostat (on some models)**



1. Touch the Bake and Broil Hi/Lo pads at the same time for 3 seconds until the display shows SF.
2. Touch the Bake pad. A two digit number shows in the display. The oven temperature can be adjusted up to (+) 35°F hotter or (-) 35°F cooler.
3. Touch the + pad to increase the temperature in 1 degree increments.  
Touch the – pad to decrease the temperature in 1 degree increments.
4. When you have made the adjustment, touch the Start/On pad to go back to the time of day display. Use your oven as you would normally.

**NOTE:** This adjustment will not affect the broiling or self-cleaning temperatures. It will be retained in memory after a power failure.

### **Using the warming drawer. (on some models)**

#### **Control Knob (on models equipped with a knob)**



Push and turn the control knob to any desired setting.

**NOTE:** The warming drawer should not be used during a self-clean cycle.

<b>Lo</b> .....	<b>Pies</b>
<b>Medium</b> (midposition on the knob) .....	<b>Casseroles</b>
<b>Hi</b> .....	<b>Meats</b>

***On Signal Light***

The On signal light is located above the control knob and glows when the knob is in the on position. It stays on until the knob is moved to the Off position.

**When Using the Warming Drawer**

The warming drawer will keep hot, cooked foods at serving temperature. Always start with hot food. Do not use to heat cold food other than crisping crackers, chips or dry cereal.

Do not line the warming drawer with aluminum foil. Foil is an excellent heat insulator and will trap heat beneath it. This will upset the performance of the drawer and could damage the interior finish.

- Preheat prior to use according to these recommended times:



<b>Setting Lo</b>	.....	<b>15 minutes</b>
<b>Setting Medium</b>	.....	<b>25 minutes</b>
<b>Setting Hi</b>	.....	<b>35 minutes</b>

- Do not put liquid or water in the warming drawer.
- For moist foods, cover them with a lid or aluminum foil.
- For crisp foods, leave them uncovered.
- Food should be kept hot in its cooking container or transferred to a heat-safe serving dish.

**CAUTION:** Plastic containers or plastic wrap will melt if in direct contact with the drawer or a hot utensil. Melted plastic may not be removable and is not covered under your warranty.

- Remove serving spoons, etc., before placing containers in warming drawer.

### Temperature Selection Chart

To keep several different foods hot, set the control to the food needing the highest setting.

- The temperature, type and amount of food, and the time held will affect the quality of the food.
- Food in heat-safe glass and glass-ceramic utensils may need a higher control setting as compared to food in metal utensils.
- Repeated opening of the drawer allows hot air to escape and food to cool.
- Allow extra time for the temperature inside the drawer to stabilize after adding items.
- With large loads it may be necessary to use a higher thermostat setting and cover some of the cooked food items.
- Do not use plastic containers or plastic wrap.



<b>Food Type</b>	<b>Control Setting</b>
Bacon	Hi
Breads	Medium
Casserole	Medium
Chicken, fried	Hi
Eggs, scrambled	Medium
Fish	Hi
Gravy, sauces	Hi
Ham	Hi
Muffins	Medium
Onion rings	Hi
Pies	Lo
Pizza	Hi
Potatoes, baked	Hi
Potatoes, mashed	Lo
Tortilla Chips	Lo

**CAUTION:** Do not keep food in the warming drawer for more than two hours.

#### **To Crisp Stale Items**

- Place food in low-sided dishes or pans.
- Preheat on Lo setting.
- Check crispness after 45 minutes. Add time as needed.

#### **To Warm Serving Bowls and Plates**

- To warm serving bowls and plates, set the control on Lo.
- Use only heat-safe dishes.
- If you want to heat fine china, please check with the manufacturer of the dishes for their maximum heat tolerance.
- You may warm empty serving dishes while preheating the drawer.

**CAUTION:** Dishes will be hot. Use pot holders or mitts when removing hot dishes.

## Using the self-cleaning oven

Never force the latch handle. Forcing the handle will damage the door lock mechanism.

The oven door must be closed and all controls set correctly for the cycle to work properly

### Before a Clean Cycle



*Wipe up heavy soil on the oven bottom.*

For the first self-clean cycle, we recommend venting your kitchen with an open window or using a ventilation fan or hood.

Remove the shelves, any broiler pan, broiler grid, all cookware and any aluminum foil from the oven.

The oven shelves can be self-cleaned, but they will darken, lose their luster and become hard to slide.

Do not use commercial oven cleaners or oven protectors in or near the self-cleaning oven. A combination of any of these products plus the high clean cycle temperatures may damage the porcelain finish of the oven.

Soil on the front frame of the range and outside the gasket on the door will need to be cleaned by hand. Clean these areas with hot water, soap-filled scouring pads or cleansers such as Soft Scrub®. Rinse well with clean water and dry.

Do not clean the gasket. The fiberglass material of the oven door gasket cannot withstand abrasion. It is essential for the gasket to remain intact. If you notice it becoming worn or frayed, replace it.

Wipe up any heavy spillovers on the oven bottom.

Make sure the oven light bulb cover is in place and the oven light is off.

**CAUTION:** The grates and drip pans (if so equipped) should never be cleaned in the self-cleaning oven.

Do not use commercial oven cleaners or oven protectors in or near the self-cleaning oven. A combination of any of these products plus the high clean cycle temperatures may damage the porcelain finish of the oven.

**IMPORTANT:** The health of some birds is extremely sensitive to the fumes given off during the self-cleaning cycle of any range. Move birds to another well ventilated room.

### How to Set the Oven for Cleaning

Follow the directions in the Before a Clean Cycle section.

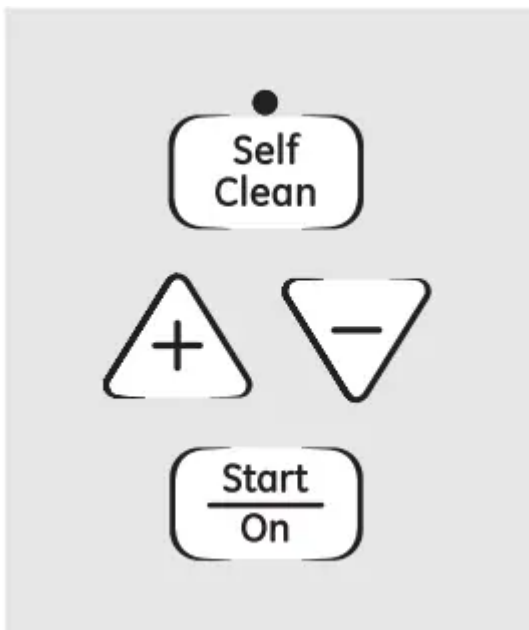

1. Latch the door.

**NOTE:** Never force the latch. If the oven is too hot, you will not be able to slide the latch. Allow the oven to cool.

2. Touch the Self Clean pad.

3. Touch the + or – pads until the desired Clean Time is displayed.

The Clean Time is normally 4 hours and 20 minutes. You can change the Clean Time to any time between 3 and 5 hours, depending on the amount of soil in your oven.

4. Touch the Start/On pad.

The self-clean cycle will automatically begin after CLEAN is displayed and the time countdown appears in the display.

While the oven is self-cleaning, you can touch the Clock pad to display the time of day. To return to the clean countdown, touch the Self Clean pad.

The oven shuts off automatically when the clean cycle is complete, and 0:00 will flash in the display.

5. Slide the latch handle to the left as far as it will go and open the door.

## Care and Cleaning

### Care and cleaning of the range

Be sure electrical power is off and all surfaces are cool before cleaning any part of the range.

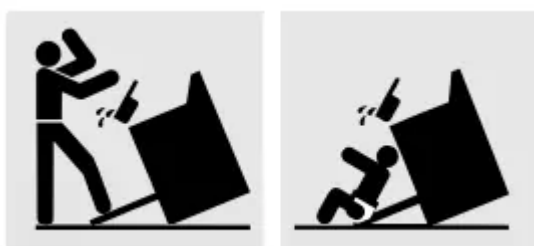

If your range is removed for cleaning, servicing or any reason, be sure the anti-tip device is re-engaged properly when the range is replaced. Failure to take this precaution could result in tipping of the range and cause injury

### Standard Twin Burner Assemblies (on some models)



**CAUTION:** Do not operate the cooktop without all burner parts, drip pans (if so equipped) and grates in place.

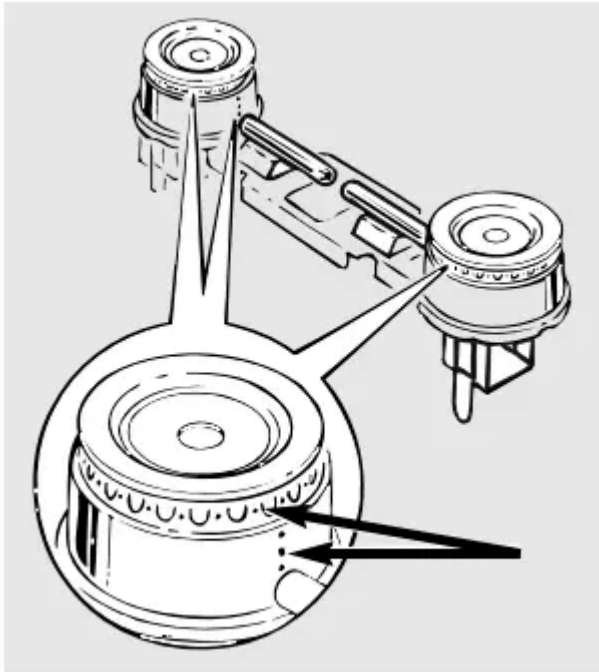

Clean these holes thoroughly on each burner

Turn all controls OFF before removing burner parts and drip pans (if so equipped).

The burner grates and drip pans (if so equipped) can be lifted off, making them easy to clean.

The holes in the surface burners of your range must be kept clean at all times for proper ignition and an even, unhampered flame.

You should clean the surface burners routinely, especially after bad spillovers, which could clog these holes.

Wipe off surface burners. If heavy spillover occurs, remove the surface burners from the range. Burners lift out for cleaning. Lift up the cooktop and then lift out the surface burners.

To remove burned-on food, soak the surface burner in a solution of mild liquid detergent and hot water. Soak the surface burner for 20 to 30 minutes.

For more stubborn stains, use a cleanser like Soft Scrub® brand or Bon Ami® brand. Rinse well to remove any traces of the cleanser that might clog the surface burner openings.

Do not use steel wool because it will clog the surface burner openings and scratch the surface burners. If the holes become clogged, clean them with a sewing needle or twist-tie.

Before putting the surface burner back, shake out excess water and then dry it thoroughly by setting it in a warm oven for 30 minutes. Then place it back in the range, making sure it is properly seated and level.

Check the flame pattern of each burner. If the flames are “jumpy” (not steady), clean the holes again with a sewing needle or twist-tie.

### **Drip Pans (if so equipped)**

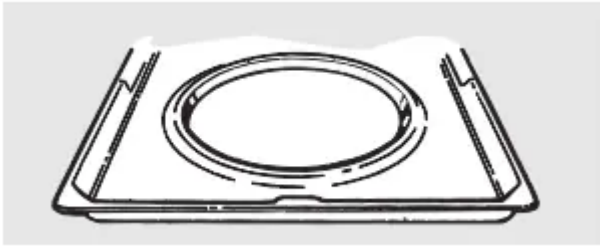

Remove the grates and lift out the drip pans. Drip pans can be cleaned in a dishwasher or by hand.

When replacing the drip pans, make sure they are in the correct position.

Place them in a covered container. Add 1/4 cup ammonia and let soak several hours or overnight. Wash, rinse well and dry.

**CAUTION:** Do not clean the drip pans in a self-cleaning oven.

### **Sealed Burner Assemblies (on some models)**



Turn all controls OFF before removing the burner parts and drip pans (if so equipped).

The burner grates, caps, burner heads and drip pans (if so equipped) can be lifted off, making them easy to clean.

**CAUTION:** Do not operate the cooktop without all burner parts, drip pans (if so equipped) and grates in place.

**NOTE:** Do not lift the cooktop. Lifting the cooktop on sealed burner models can lead to damage and improper operation of the range.



The electrode of the spark igniter is exposed when the burner head is removed. When one burner is turned to **LITE**, all the burners spark. Do not attempt to disassemble or clean around any burner while another burner is on. An electric shock may result, which could cause you to knock over hot cookware.

### **Burner Caps and Heads**

**NOTE:** Before removing the burner caps and heads, remember their size and location. Replace them in the same location after cleaning

#### **Burner caps**

Lift off when cool. Wash burner caps in hot, soapy water and rinse with clean water. You may scour with a plastic scouring pad to remove burned-on food particles.

#### **Burner heads**

For proper ignition, make sure the small hole in the section that fits over the electrode is kept open. A sewing needle or wire twist-tie works well to unclog it.

The slits in the burner heads must be kept clean at all times for an even, unhampered flame.

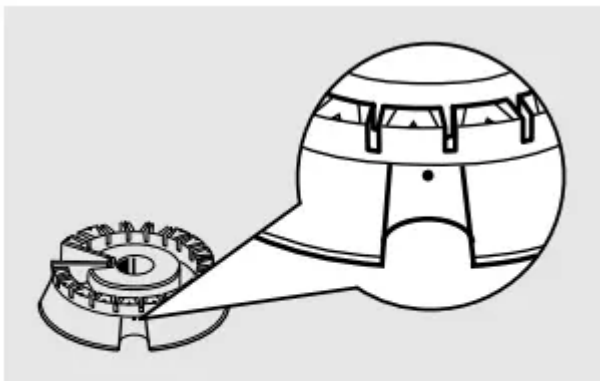

*Use a sewing needle or twist-tie to unclog the small hole in the burner head.*

Clogged or dirty burner ports or electrodes will not allow the burner to operate properly.

Any spill on or around an electrode must be carefully cleaned. Take care to not hit an electrode with anything hard or it could be damaged.

You should clean the burner caps and burner heads routinely, especially after bad spillovers, which could clog the openings in the burner heads. Lift off when cool.

To remove burned-on food, soak the burner heads in a solution of mild liquid detergent and hot water for 20–30 minutes. For more stubborn stains, use a toothbrush.

### After cleaning

Before putting the burner caps and heads back, shake out excess water and then dry them thoroughly by setting in a warm oven for 30 minutes.

**NOTE:** Do not use steel wool or scouring powders to clean the burners.

### Replacement

Replace burner heads over the electrodes on the cooktop, in the correct locations according to their size.

**On some models:**



**On some models:**



Make sure the slot in the burner head is positioned over the electrode.



Replace the matching size caps onto the heads.

Make sure that the heads and caps are replaced in the correct locations.

**NOTE:** On some models, the burners are all the same size and power.

### Burner Grates

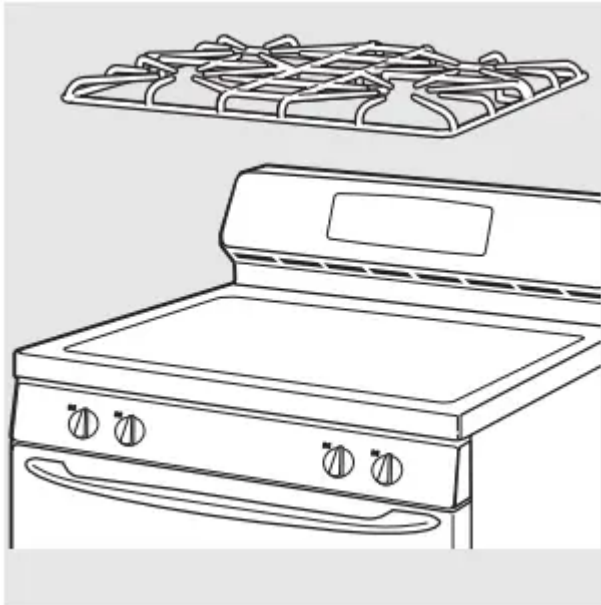

Lift out when cool. Grates should be washed regularly and, of course, after spillovers. Wash them in hot, soapy water and rinse with clean water. When replacing the grates, be sure they are positioned securely over the burners.

On models with professional-style double grates, the grates are position-specific. For maximum stability, these grates should only be used in their proper position; they cannot be interchanged left to right or front to back. For convenience, the undersides of the left and right grates are marked “LEFT FRONT” and “RIGHT FRONT.”

Do not operate a burner for an extended period of time without cookware on the grate. The finish on the grate may chip without cookware to absorb the heat.

To get rid of burned-on food, place the grates in a covered container. Add 1/4 cup ammonia and let them soak several hours or overnight. Wash, rinse well and dry.

Although they are durable, the grates will gradually lose their shine, regardless of the best care you can give them. This is due to their continual exposure to high temperatures. You will notice this sooner with lighter color grates.

**NOTE:** Do not clean the grates in a self-cleaning oven.

### **Cooktop Surface**



To avoid damaging the porcelain enamel surface of the cooktop and to prevent it from becoming dull, clean up spills right away. Foods with a lot of acid (tomatoes, sauerkraut, fruit juices, etc.) or foods with high sugar content could cause a dull spot if allowed to set.

When the surface has cooled, wash and rinse. For other spills such as fat splatterings, etc., wash with soap and water once the surface has cooled. Then rinse and polish with a dry cloth.

**NOTE:** Do not store flammable materials in an oven or near the cooktop. Do not store or use combustible materials, gasoline or other flammable vapors and liquids in the vicinity of this or any other appliance.

**NOTE:** Do not lift the cooktop on sealed burner models. Lifting the cooktop can lead to damage and improper operation of the range.

### **Stainless Steel Surfaces (on some models)**

Do not use a steel wool pad; it will scratch the surface.

To clean the stainless steel surface, use warm sudsy water or a stainless steel cleaner or polish. Always wipe the surface in the direction of the grain. Follow the cleaner instructions for cleaning the stainless steel surface.

### **Lift-Off Oven Door**

The oven door is removable, but it is heavy. You may need help removing and replacing the door.

To remove the door, open it a few inches to the special stop position that will hold the door open. Grasp firmly on each side and lift the door straight up and off the hinges.

**NOTE:** Be careful not to place hands between the hinge and the oven door frame as the hinge could snap back and pinch fingers



*Lift the door straight up and off the hinges.*

To replace the door, make sure the hinges are in the special stop position. Position the slots in the bottom of the door squarely over the hinges. Then lower the door slowly and evenly over both hinges at the same time. If the hinges snap back against the oven frame, pull them back out.



*The gasket is designed with a gap at the bottom to allow for proper air circulation.*

*Do not rub or clean the door gasket— it has an extremely low resistance to abrasion.*

*If you notice the gasket becoming worn, frayed or damaged in any way or if it has become displaced on the door, you should have it replaced.*

**To clean the inside of the door:**

- Do not allow excess water to run into any holes or slots in the door.

- Because the area inside the gasket is cleaned during the self clean cycle, you do not need to clean this by hand. Any soap left on the liner causes additional stains when the oven is heated.
- The area outside the gasket can be cleaned with a soap-filled scouring pad.

To clean the outside of the door:

- Use soap and water to thoroughly clean the top, sides and front of the oven door. Rinse well. You may also use a glass cleaner to clean the glass on the outside of the door.
- Spillage of marinades, fruit juices, tomato sauces and basting materials containing acids may cause discoloration and should be wiped up immediately. When the surface is cool, clean and rinse.
- Do not use oven cleaners, cleansing powders or harsh abrasives on the outside of the door.

### Oven Bottom

The oven bottom has a porcelain enamel finish. To make cleaning easier, protect the oven bottom from excessive spillovers by placing a cookie sheet on the shelf below the shelf you are cooking on. This is particularly important when baking a fruit pie or other foods with a high acid content. Hot fruit fillings or other foods that are highly acidic (such as tomatoes, sauerkraut, and sauces with vinegar or lemon juice) may cause pitting and damage to the porcelain enamel surface and should be wiped up immediately.

We don't recommend using aluminum foil on the oven bottom. It can affect air flow if the holes are blocked and it can concentrate heat at the bottom of the oven, resulting in poor baking performance.

To clean up spillovers, use soap and water, an abrasive cleaner or soap-filled scouring pad. Rinse well to remove any soap before self-cleaning

### Removable Kick Panel (on some models)

The kick panel may be removed for cleaning under the range.



To remove: Lift up the bottom of the panel slightly to disengage the panel from the tabs at the base of the range. Pull the bottom of the panel forward until the spring clips are released at the top of the panel.



To replace: Insert the two slots at the bottom of the panel onto the two tabs at the base of the range, and push the top of the panel forward to engage the spring clips.

#### **Removable Storage Drawer (on some models)**

The storage drawer is a good place to store cookware and bakeware. Do not store plastics and flammable material in the drawer.



*The storage drawer may be removed for cleaning under the range.*

The storage drawer may be removed for cleaning under the range. Clean the storage drawer with a damp cloth or sponge. Never use harsh abrasives or scouring pads.

To remove storage drawer:

1. Pull drawer straight out until it stops.
2. Tilt the front of the drawer up and free of the range.

To replace storage drawer:

1. Set the stops on the back of the drawer over the stops in the range.
2. Slide drawer evenly and straight back, so that the rails in the range are engaged.

### Removable Warming Drawer (on some models)

**NOTE:** For models with an electric warming drawer, before performing any adjustments, cleaning or service, disconnect the range electrical power supply at the household distribution panel by removing the fuse or switching off the circuit breaker. Make sure the warming drawer heating element is cool.



Most cleaning can be done with the drawer in place. However, the drawer may be removed if further cleaning is needed. Use soap and warm water to thoroughly clean.



To remove the warming drawer:

1. Pull the drawer straight out until it stops.

2. Press the left rail release up and press the right rail release down, while pulling the drawer forward and free.

**To replace the warming drawer:**

1. Place the left drawer rail around the inner left rail guide and slide it in slightly to hook it.
2. Place the right drawer rail around the inner right rail guide and slide it in slightly to hook it.
3. Slide the drawer all the way in.

**Lift-Up Cooktop (on models with standard twin burners)**

Clean the area under the cooktop often. Built-up soil, especially grease, may catch on fire.

To make cleaning easier, the cooktop may be lifted up.

**NOTE:** Do not lift the cooktop on sealed burner models. Lifting the cooktop can lead to damage and improper operation of the range.



*Some models have dual support rods that will hold the cooktop up while you clean underneath it.*

To raise the cooktop:

1. Be sure the burners are turned off.
2. Remove the grates.
3. Grasp the two front burner wells and lift up.

Clean under the cooktop with hot, soapy water and a clean cloth. If you removed your surface burners while cleaning, make sure they are properly seated when replacing them.

After cleaning, lower the cooktop (be careful not to pinch your fingers).

**Oven Air Vents**



*Vent appearance and location vary.*

Never block the vents (air openings) of the range. They provide the air inlet and outlet that are necessary for the range to operate properly with correct combustion.

Air openings are located at the rear of the cooktop, at the top and bottom of the oven door, and at the bottom of the range, under the warming drawer, storage drawer or kick panel (depending on the model).

#### **Lower Control Panel (Front Manifold Panel) and Knobs**

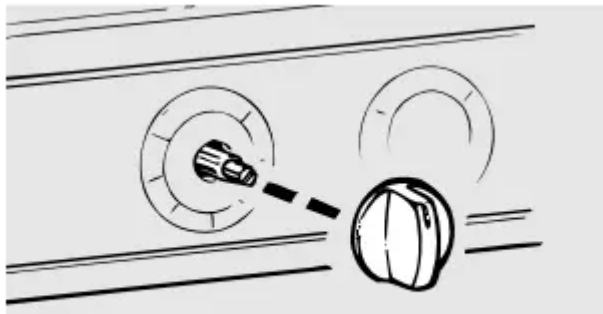

*Pull the knob straight off the stem.*

It's a good idea to wipe the control panel after each use of the oven. Use a damp cloth to clean or rinse. For cleaning, use mild soap and water or a 50/50 solution of vinegar and water. For rinsing, use clean water. Polish dry with a soft cloth.

Do not use abrasive cleansers, strong liquid cleaners, plastic scouring pads or oven cleaners on the control panel—they will damage the finish.

Do not bend knobs by pulling them up or down or by hanging a towel or other such loads. This can damage the gas valve shaft.

The control knobs may be removed for easier cleaning.

Make sure the knobs are in the Off positions and pull them straight off the stems for cleaning.

The knobs can be cleaned in a dishwasher or they may also be washed with soap and water. Make sure the insides of the knobs are dry before replacing.

Replace the knobs in the Off position to ensure proper placement.

Metal parts can be cleaned with soap and water. Do not use steel wool, abrasives, ammonia, acids or commercial oven cleaners. Dry with a soft cloth.

### Oven Shelves

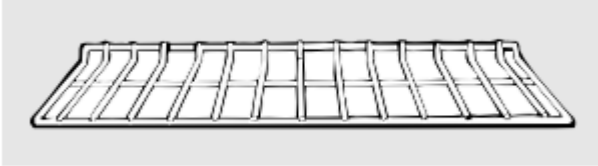

Clean the shelves with an abrasive cleanser or scouring pad. After cleaning, rinse the shelves with clean water and dry with a clean cloth.

If the shelves ever become hard to slide, wipe the shelf edges or oven shelf supports with vegetable oil.

**NOTE:** Take the shelves out of the oven before you begin the self-clean cycle or they may discolor.

### Oven Light Replacement



*Wire cover holder.*

**CAUTION:** Before replacing your oven light bulb, disconnect the electrical power to the range at the main fuse or circuit breaker panel. Be sure to let the light cover and bulb cool completely.

The oven light bulb is covered with a removable glass cover that is held in place with a bail-shaped wire. Remove the oven door, if desired, to reach cover easily

#### To remove:

1. Hold a hand under the cover so it doesn't fall when released. With fingers of the same hand, firmly push back the wire cover holder. Lift off the cover.

Do not remove any screws to remove the cover.

2. Do not touch hot bulb with a wet cloth. Replace bulb with a 40-watt household appliance bulb

To replace cover:

1. Place it into the groove of the light receptacle. Pull the wire forward to the center of the cover until it snaps into place. When in place, the wire holds the cover firmly. Be certain the wire is in the depression in the center of the cover.
2. Connect electrical power to the range.

# Troubleshooting



Problem	Possible Causes	What To Do
Top burners do not light or do not burn evenly	Plug on range is not completely inserted in the electrical outlet	Make sure electrical plug is plugged into a live, properly grounded outlet.
	Burner hole or slits on the side of the burner may be clogged.	Remove the burners (on models with standard twin burners) or burner heads and caps (on models with sealed burners) and clean them with a sewing needle or twist-tie. Make sure you do not enlarge the holes. On sealed burner models, check and clean the electrode area for burned-on food or grease.
	Improper burner assembly	Make sure the burner parts are installed correctly. See the Care and cleaning of the range section.
Burner flames very large or yellow	Improper air to gas ratio.	If range is connected to LP gas, contact the person who installed your range or made the conversion.
Surface burners light but oven does not	The oven gas shut-off valve may have accidentally been moved during cleaning or moving.	<ul style="list-style-type: none"> <li>• To check the oven gas shut-off valve on sealed burner models, remove the warming drawer, storage drawer or kick panel (see the Care and cleaning of the range section) and look for the gas shut-off lever at the back of the range.</li> </ul>

		 <p>To check the oven gas shut-off valve on standard twin burner models, raise the cooktop and look for the gas shut-off lever at the extreme right rear corner. Follow the directions in box A or B that match your regulator type.</p> 
Control signals after entering cooking time or start time (on some models)	You forgot to enter a bake temperature or cleaning time.	Touch the Bake pad and desired temperature or the Self Clean pad and desired clean time.
Clock and timer do not work (on some models)	Plug on range is not completely inserted in the electrical outlet.	Make sure electrical plug is plugged into a live, properly grounded outlet.
	A fuse in your home may be blown or the circuit breaker tripped.	Replace the fuse or reset the circuit breaker.
	Oven controls improperly set.	See the Using the clock and timer section
Food does not bake or roast properly	Oven controls improperly set.	See the Using the oven section.
	Shelf position is incorrect.	See the Using the oven section
	Incorrect cookware or cookware of improper size being used.	See the Using the oven section

	Oven thermostat needs adjustment	See the Adjust the oven thermostat—Do it yourself! section.
	Clock not set correctly. (on some models)	See the Using the clock and timer section.
	Aluminum foil used improperly in the oven.	See the Care and cleaning of the range section.
	Oven bottom not securely seated in position.	See the Installation of the range section
Food does not broil properly	Oven controls improperly set.	On models with touch pads, make sure you touch the Broil Hi/Lo pad. On models with an OVEN TEMP knob, make sure it is set at BROIL.
	Oven door not closed.	See the Using the oven section.
	Improper shelf position being used.	See the Broiling Guide.
	Food being cooked in a hot pan	For best results, use a pan designed for broiling. Make sure it is cool.
	Cookware not suited for broiling.	For best results, use a pan designed for broiling.
	Oven bottom not securely seated in position.	See the Installation of the range section.
Oven temperature too hot or too cold	Oven thermostat needs adjustment.	See the Adjust the oven thermostat—Do it yourself! section.
Oven light does not work	Light bulb is loose or defective.	Tighten or replace the bulb.
	Plug on range is not completely inserted in the electrical outlet.	Make sure electrical plug is plugged into a live, properly grounded outlet.



Oven will not self-clean	The oven temperature is too high to set a self-clean operation.	Allow the range to cool to room temperature and reset the controls.
	Oven controls improperly set.	See the Using the self-cleaning oven section.
	On models with a door latch, the oven door is not in the locked position.	Make sure you move the door latch handle all the way to the right.
"Crackling" or "popping" sound	This is the sound of the metal heating and cooling during both the cooking and cleaning functions.	This is normal.
Excessive smoking	Excessive soil.	On models with touch pads, touch the Clear/Off pad. On models with an OVEN TEMP knob, turn it to OFF. Open the windows to rid the room of smoke. Wait until the SELF CLEAN light goes off. Wipe up the excess soil and reset the clean cycle.
Oven door will not open after a clean cycle	Oven too hot.	Allow the oven to cool below locking temperature
Oven not clean after a clean cycle	Oven controls not properly set.	See the Using the self-cleaning oven section.
	Oven was heavily soiled.	Clean up heavy spillovers before starting the clean cycle. Heavily soiled ovens may need to self-clean again or for a longer period of time.
Oven door will not unlock (on models with a door latch)	Oven too hot	Allow the oven to cool below locking temperature.  Do not lock the door with the

		door latch except when using the self-clean feature.
Self clean light (on some models) blinks when trying to set a self clean cycle	The OVEN TEMP knob has not been set to CLEAN when the latch was moved to the right.	Set the OVEN TEMP knob to CLEAN. See the Using the sell-cleaning oven section.
	The latch was not moved to the right when the OVEN TEMP knob was set to CLEAN.	Move the latch to the right as far as it will go. See the Using the sell-cleaning oven section.
Self clean light (on some models) blinks during self clean cycle	A power interruption occurred.	Turn the OVEN TEMP knob to OFF and move the latch to the left as far as it will go. Reset the range controls to the desired settings. See the Using the self-cleaning oven section.
"Door" appears in the display (on some models)	Self-cleaning cycle has been selected but the latch handle was not moved all the way to the right.	Move the latch handle all the way to the right.
	Latch handle was moved to the right but a program other than self-cleaning was selected.	Move the latch handle to the right only when setting the self-cleaning cycle.
"F—and a number or letter" flash in the display (on some models)	On models with a door latch, if a function error code appears during the self-cleaning cycle, check the oven door latch.	The latch may have been moved, even if only slightly, from the locked position. Make sure the latch is moved to the right as far as it will go.
	You have a function error code.	Touch the Clear/Off pad. Allow the oven to cool for one hour. Put the oven back into operation.
	If the function code repeats.	Disconnect all power to the range for 5 minutes and then



		reconnect power. If the function error code repeats, call for service.
Display goes blank (on some models)	A fuse in your home may be blown or the circuit breaker tripped.	Replace the fuse or reset the circuit breaker.
	The clock is turned off so that it does not show in the display.	See the Using the clock and timer section.
Display flashes (on some models)	Power failure.	Reset the clock.
Unable to get the display to show "SF" (on some models)	Oven control pads were not touched properly.	The Bake and Broil Hi/Lo pads must be touched at the same time and held for 3 seconds.
Power outage, clock flashes (on some models)	Power outage or surge.	Reset the clock. If the oven was in use, you must reset it by touching the Clear/Off pad, setting the clock and resetting any cooking function.
"Burning" or "oily" odor emitting from the vent	This is normal in a new oven and will disappear in time.	To speed the process, set a self-clean cycle for a minimum of 3 hours. See the Using the self-cleaning oven section.
Strong odor	An odor from the insulation around the inside of the oven is normal for the first few times the oven is used.	This is temporary.
Fan noise	A cooling fan may automatically turn on and off to cool internal parts.	This is normal. The cooling fan will turn off and on
Drawer does not slide smoothly or drags	The drawer is out of alignment.	Fully extend the drawer and push it all the way in. See the



		Care and cleaning of the range section.
	Drawer is over-loaded or load is unbalanced.	Reduce weight. Redistribute drawer contents.

**Warning**

This content is compiled from multiple sources and is provided for reference purposes only. It may not be complete or fully applicable to all situations. If you are unable to resolve your issue, please contact the product manufacturer or an authorized service provider for official support.

