

FEATURES

Controls with temperature settings

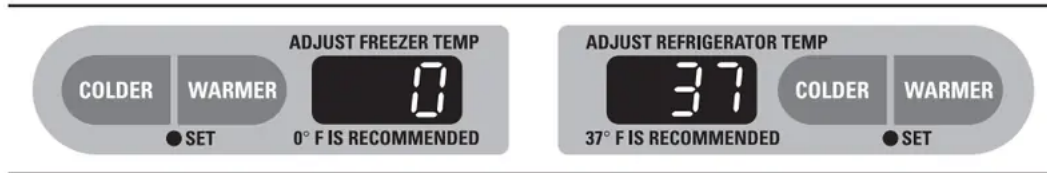

NOTE: The refrigerator is shipped with protective film covering the temperature controls. If this film was not removed during installation, remove it now

The temperature controls are preset in the factory at 37°F for the refrigerator compartment and 0°F for the freezer compartment. Allow 24 hours for the temperature to stabilize to the preset recommended settings.

The temperature controls can display both the SET temperature as well as the actual temperature in the refrigerator and freezer. The actual temperature may vary slightly from the SET temperature based on usage and operating environment.

Setting either or both controls to OFF stops cooling in both the freezer and refrigerator compartments, but does not shut off electrical power to the refrigerator

Changing the Temperature

To change the temperature, press and release the WARMER or COLDER pad. The SET light will come on and the display will show the set temperature.

To change the temperature, tap either the **WARMER** or **COLDER** pad until the desired temperature is displayed. Refrigerator temperatures can be adjusted between 34°F and 47°F and the freezer temperatures can be adjusted between -6°F and +8°F.

Once the desired temperature has been set, the temperature display will return to the actual refrigerator and freezer temperatures after 5 seconds. Several adjustments may be required.

Each time you adjust controls, allow 24 hours for the refrigerator to reach the temperature you have set.

To turn the cooling system off, tap the **WARMER** pad for either the refrigerator or the freezer until the display shows OFF.

To turn the unit back on, press the COLDER pad for either the refrigerator or freezer. The SET light will illuminate on the side you selected. Then press the COLDER pad again (on the side where the SET light is illuminated) and it will go to the preset points of 0°F for the freezer and 37°F

for the refrigerator. Setting either or both controls to OFF stops cooling in both the freezer and refrigerator compartments, but does not shut off electrical power to the refrigerator.

Performance Air Flow System

The Performance Air Flow System is designed to maximize temperature control in the refrigerator and freezer compartments. This unique special feature consists of the Air Tower along the back wall of the refrigerator and the Air Tunnel on the bottom portion of the freezer rear wall. Placing food in front of the louvers on these components will not affect performance.

About TurboCool.™ (on some models)

How it Works



TurboCool rapidly cools the refrigerator compartment in order to more quickly cool foods. Use TurboCool when adding a large amount of food to the refrigerator compartment, putting away foods after they have been sitting out at room temperature or when putting away warm leftovers. It can also be used if the refrigerator has been without power for an extended period.

Once activated, the compressor will turn on immediately and the fans will cycle on and off at high speed as needed for eight hours. The compressor will continue to run until the refrigerator compartment cools to approximately 34°F (1°C), then it will cycle on and off to maintain this setting. After 8 hours, or if TurboCool is pressed again, the refrigerator compartment will return to the original setting

How to Use

1. Press TurboCool. The refrigerator temperature display will show.
2. After TurboCool is complete, the refrigerator compartment will return to the original setting.

NOTES: The refrigerator temperature cannot be changed during TurboCool.

The freezer temperature is not affected during TurboCool.

When opening the refrigerator door during TurboCool, the fans will continue to run if they have cycled on.

About the controls with numbered settings



NOTE: The refrigerator is shipped with protective film covering the temperature controls. If this film was not removed during installation, remove it now

Initially, set the refrigerator control at 5 and the freezer control at 5 and allow 24 hours for the temperature to stabilize.

Several adjustments may be required. Adjust the controls one increment at a time, and allow 24 hours after each adjustment for the refrigerator to reach the temperature you have set.

Setting either or both controls to 0 stops cooling in both the refrigerator and freezer compartments, but does not shut off electrical power to the refrigerator

Performance Air Flow System

The Performance Air Flow System is designed to maximize temperature control in the refrigerator and freezer compartments. This unique special feature consists of the Air Tower along the back wall of the refrigerator and the Air Tunnel on the bottom portion of the freezer rear wall. Placing food in front of the louvers on these components will not affect performance.

About the water filter

Water Filter Cartridge

The water filter cartridge is located in the back upper right corner of the refrigerator compartment.

When to Replace the Filter

There is a replacement indicator light for the water filter cartridge on the temperature display. This light will turn orange to tell you that you need to replace the filter soon. The filter cartridge should be replaced when the replacement indicator light turns red or if the flow of water to the dispenser or icemaker decreases.

Installing the Filter Cartridge

	<p>1. If you are replacing the cartridge, first remove the old one. Open the cartridge cover by pressing in on the tab at the front and pulling down.</p>
	<p>2. Remove the cartridge by slowly rotating it counterclockwise. A small amount of water may drip down.</p> <p>CAUTION: If air has been trapped in the system, the filter cartridge may be ejected as it is removed. Use caution when removing.</p>
<p>3. Remove the protective foil from the end of the cartridge.</p>	
	<p>4. Lining up the arrow on the cartridge and the cartridge holder, slowly rotate the cartridge clockwise until it stops. When the cartridge is properly installed, you will feel it “click” as it locks into place. The blade on the end of the cartridge should be positioned vertically. Do not overtighten.</p>
<p>5. Close the cartridge cover.</p>	
<p>6. Run water from the dispenser for 3 minutes (about 1 1/2 gallons) to clear the system and prevent sputtering. See To Use the Dispenser section.</p>	
 <p>(on some models)</p>	<p>7. Press and hold the RESET WATER FILTER pad for 3 seconds.</p> <p>NOTE: A newly-installed water filter cartridge may cause water to spurt from the dispenser.</p>

About the shelves and bins

Rearranging the Shelves

Shelves in the refrigerator compartment are adjustable.

Refrigerator Compartment

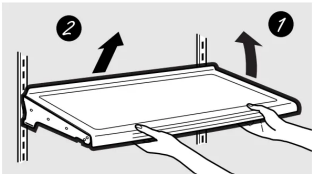
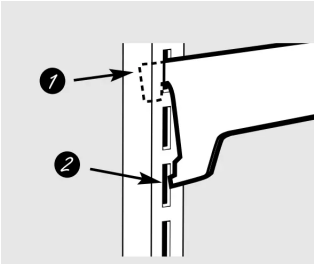
 <p>Some models have wire shelves that can be adjusted in the same manner</p>	<p><i>To remove:</i></p> <ol style="list-style-type: none">1. Tilt the shelf up at the front.2. Lift the shelf up at the back and bring the shelf out.
	<ol style="list-style-type: none">1. While tilting the shelf up, insert the top hook at the back of the shelf in a slot on the track2. Lower the front of the shelf until the bottom of the shelf locks into place.

Spillproof Shelves (on some models)

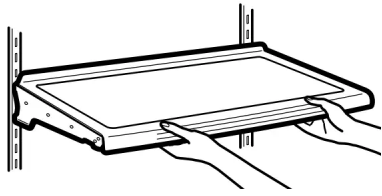
	<p>Spillproof shelves have special edges to help prevent spills from dripping to lower shelves. To remove or replace the shelves, see Rearranging the Shelves.</p>
---	--

Slide-Out Spillproof Shelf (on some models)

The slide-out spillproof shelf allows you to reach items stored behind others. The special edges are designed to help prevent spills from dripping to lower shelves.



To remove:

1. Remove all items from shelf.
2. Slide the shelf out until it stops.
3. Lift the front edge of the shelf until the central tabs are above the front bar.
4. Continue pulling the shelf forward until it can be removed.

To replace:

1. Place the rear shelf tabs just in front of the central notches on the shelf frame.
2. Slide the shelf in until the central tabs are slightly behind the front bar.
3. Lower the shelf into place until it is horizontal and slide the shelf in.

NOTE:

- Make sure that the shelf sits flat after reinstallation and doesn't move freely from side to side.
- Make sure you push the shelves all the way in before you close the door

Adjustable Bins on the Door



Adjustable bins can easily be carried from refrigerator to work area.

To remove: Lift bin straight up, then pull out.

To replace or relocate: Engage the bin in the molded supports of the door, and push in. Bin will lock in place.

The snugger helps prevent tipping, spilling or sliding of small items stored on the door shelf. Grip the finger hold near the rear of the snugger and move it to fit your needs.

Non-Adjustable Shelves on the Door



To remove: Lift the shelf straight up, then pull out.

To replace: Engage the shelf in the molded supports on the door and push down. It will lock in place.

About the additional features

Not all features are on all models.

	<p>Shelf Saver Rack (on some models)</p>
--	---

Slide-out beverage rack holds twelve cans of soda or two wine/water bottles (lengthwise). It can be removed for cleaning.

To remove, slide the rack out to the stop position, lift the rack up and past the stop position and lift it out.

About the crispers and pans

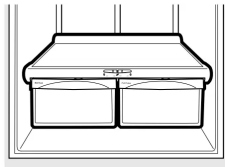

Fruit and Vegetable Crisper

Excess water that may accumulate in the bottom of the drawers or under the drawers should be wiped dry.

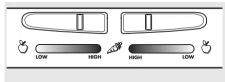

Adjustable Humidity Crisper (on some models)

Slide the control all the way to the HIGH setting to provide high humidity recommended for most vegetables. Slide the control all the way to the LOW setting to provide lower humidity levels recommended for most fruits.

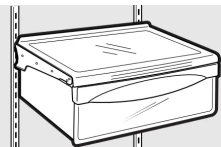

Snack Pan (on some models)

This pan can be moved to the most useful location for your family's needs.

To remove, slide the pan out to the stop position, lift the pan up and past the stop position and lift it out.

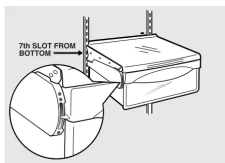

Adjustable Temperature Deli Pan (on some models)

When the pan is placed in the 7th slot from the bottom of the track and the lever is set at COLDEST, air from the freezer is forced around the pan to keep it very cold.

You can move the pan to any location if you don't want the extra cold storage.

The settings can be adjusted anywhere between cold



and coldest



When set at cold, the pan will stay at the normal refrigerator temperature.

The coldest setting provides the coldest storage area.



Crisper Removal

To Remove:

These drawers can be removed easily by lifting up slightly while pulling the drawer past the stop location.

When the door cannot be fully opened,

7remove the drawer farthest from the door first. Make sure the drawer closest to the door is fully closed. There is a latch at the front of the center slide rail. Push down on the latch and slide the center slide rail, to which the drawer is attached, away from the door. Remove the drawer



About the freezer

Freezer Shelves and Baskets



Depending on your model, your freezer may feature:

1. A deep full-width basket
2. A shallow full-width basket
3. A half-width basket
4. A full-width wire shelf
5. A shelf above the ice storage bin

Basket/Shelf Removal

	<p><i>To remove the deep full-width basket on freezer drawer models:</i></p> <ol style="list-style-type: none"> 1. Open the freezer drawer until it stops. 2. The freezer basket rests on a frame inside the freezer drawer. Lift the basket up at the back. 3. Lift the front up and lift the entire basket up and out of the drawer.
	<p><i>To remove the half-width basket:</i></p> <ol style="list-style-type: none"> 1. Pull the basket out to the stop location. 2. Lift the basket up at the front to release it from the slides. 3. Lift the back up and out of the slide. <p>When replacing the basket, make sure that the wire tabs and wire hooks on the sides of the basket go into the slots in the top of the upper basket slides.</p> <p>NOTE: Always be sure to fully close this basket. You will know it is fully closed when you feel it “click” into place.</p>
	<p><i>To remove the deep full-width baskets on freezer door models, the shallow full-width basket and the full-width wire shelf:</i></p> <ol style="list-style-type: none"> 1. Pull the basket/shelf out to the stop location. 2. Lift the front up and over the stop location. 3. Lift the basket/shelf up and out.
	<p><i>To remove the shelf above the ice bin:</i></p> <p>Pull the shelf straight out.</p>

About the automatic icemaker

A newly installed refrigerator may take 12 to 24 hours to begin making ice.



Automatic Icemaker (on some models)

The icemaker will produce seven cubes per cycle—approximately 100–130 cubes in a 24-hour period, depending on freezer compartment temperature, room temperature, number of door openings and other use conditions.

See below for how to access ice and reach the power switch.

If the refrigerator is operated before the water connection is made to the icemaker, set the power switch in the O (off) position. The icemaker power light will turn green when the freezer light switch is pressed in or when the freezer door is closed.

When the refrigerator has been connected to the water supply, set the power switch to the I (on) position.

The icemaker will fill with water when it cools to 15°F (–10°C). A newly installed refrigerator may take 12 to 24 hours to begin making ice cubes.

You will hear a buzzing sound each time the icemaker fills with water.

Throw away the first few batches of ice to allow the water line to clear.

Be sure nothing interferes with the sweep of the feeler arm.

When the bin fills to the level of the feeler arm, the icemaker will stop producing ice. It is normal for several cubes to be joined together.

If ice is not used frequently, old ice cubes will become cloudy, taste stale and shrink.

NOTE: In homes with lower-than-average water pressure, you may hear the icemaker cycle multiple times when making one batch of ice.

Accessing Ice and Reaching the Power Switch

	<p><i>To reach the icemaker power switch, pull the shelf above the ice bin straight out. Always be sure to replace the shelf.</i></p> <p><i>To access ice, simply pull the bin forward.</i></p>	
--	---	--

To Use the Dispenser (on some models)



The water dispenser is located on the left wall inside the refrigerator compartment.

To dispense water:

1. Hold the glass against the recess.
2. Push the water dispenser button.
3. Hold the glass underneath the dispenser for 2–3 seconds after releasing the dispenser button. Water may continue to dispense after the button is released.

If no water is dispensed when the refrigerator is first installed, there may be air in the water line system.

Press the dispenser button for at least 2 minutes to remove trapped air from the water line and to fill the water system. During this process, the dispenser noise may be loud as the air is purged from the water line system. To flush out impurities in the water line, throw away the first 6 glassfuls of water.

NOTE: To avoid water deposits, the dispenser should be cleaned periodically by wiping with a clean cloth or sponge.

INSTALLATION

PREPARATION





MOVING THE REFRIGERATOR INDOORS

If the refrigerator will not fit through a doorway, the refrigerator door and freezer drawer or door (depending on model) can be removed.

- To remove the refrigerator door, see Step 1 in the Reversing the Door Swing section.
- To remove the freezer drawer, see the Removing the Freezer Drawer section.
- To remove the freezer door, see Steps 2 and 3 in the Reversing the Door Swing section.

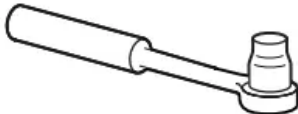
TOOLS YOU MAY NEED

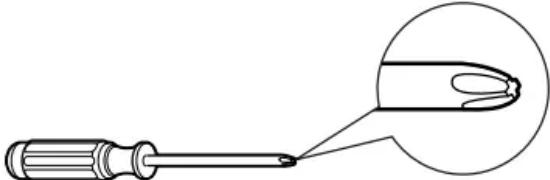
TOOLS YOU MAY NEED

 <p>Adjustable Wrench</p>	 <p>3/8" and 10 mm Socket Ratchet/Driver</p>
 <p>1/4" Outer Diameter Compression Nut and Ferrule (sleeve) (icemaker models only)</p>	 <p>Phillips Head Screwdriver</p>
 <p>3/32" Allen wrench supplied for use on Stainless steel refrigerator handles (on some models)</p>	 <p>1/4" Allen wrench supplied for changing handle fasteners location (on some models)</p>

INSTALLING THE REFRIGERATOR

REFRIGERATOR LOCATION

- Do not install the refrigerator where the temperature will go below 60°F (16°C) because it will not run often enough to maintain proper temperatures.
- Do not install the refrigerator where the temperature will go above 100°F (37°C) because it will not perform properly.
- Install it on a floor strong enough to support it fully loaded.

CLEARANCES

Allow the following clearances for ease of installation, proper air circulation and plumbing and electrical connections.

- Sides 1/8" (4 mm)
- Top 1" (25 mm)
- Back 1" (25 mm)

REMOVE TOP CAP (on some models)

IMPORTANT NOTE:

- This refrigerator is 34-1/2" deep. Doors and passageways leading to the installation location must be at least 36" wide in order to leave the doors and handles attached to the refrigerator while transporting it into the installation location. If passageways are less than 36", the refrigerator doors and handles can easily be scratched and damaged. The top cap and doors can be removed to allow the refrigerator to be safely moved indoors. Start with Step A.
- If it is not necessary to remove doors, skip Step A. Leave tape and all packaging on doors until the refrigerator is in the final location.

SKID REMOVAL: Tilt refrigerator to each side to remove skid.

NOTE: Use a padded hand truck to move this refrigerator. Place the refrigerator on the hand truck with a side against the truck. We strongly recommend that TWO PEOPLE move and complete this installation.

A Locate and remove the two Phillips head screws on the top of the refrigerator. Remove the two screws on each side at the rear of the top cap. Lift off and remove top cap.

B Remove the fresh-food door. Refer to Steps 1 through 3 of "Reversing the Door Swing" section.

C Remove the bottom freezer drawer. Refer to "Removing Freezer Drawer" section.

D Move refrigerator to the installation location.

REINSTALL DOORS, DRAWERS AND TOP CAP

E Carefully lower the door onto the center hinge. Reinstall top hinge. NOTE: Ensure the door is properly aligned to the case top to avoid readjustment of the door during top cap reinstallation.

F Place cap over the top of the refrigerator. Reinstall the original screws in the top and back of the cap.

G Reinstall the bottom freezer drawer. Refer to “Replacing the Freezer Drawer” section



1. CONNECTING THE REFRIGERATOR TO THE HOUSE WATER LINE (icemaker and dispenser models)

A cold water supply is required for automatic icemaker operation. If there is not a cold water supply, you will need to provide one. See Installing the Water Line section.

NOTES:

- Before making the connection to the refrigerator, be sure the refrigerator power cord is not plugged into the wall outlet.
- If your refrigerator does not have a water filter, we recommend installing one if your water supply has sand or particles that could clog the screen of the refrigerator's water valve. Install it in the water line near the refrigerator. If using GE SmartConnect™ Refrigerator Tubing Kit, you will need an additional tube (WX08X10002) to connect the filter. Do not cut plastic tube to install filter

A If you are using copper tubing, place a compression nut and ferrule (sleeve) onto the end of the tubing coming from the house cold water supply. If you are using the GE SmartConnect™ tubing, the nuts are already assembled to the tubing.

B If you are using copper tubing, insert the end of the tubing into the refrigerator connection, at the back of the refrigerator, as far as possible. While holding the tubing, tighten the fitting.

If you are using GE SmartConnect™ tubing, insert the molded end of the tubing into the refrigerator connection, at the back of the refrigerator, and tighten the compression nut until it is hand tight. Then tighten one additional turn with a wrench. Overtightening may cause leaks.

C Fasten the tubing into the clamp provided to hold it in position. You may need to pry open the clamp.

One of the illustrations below will look like the connection on your refrigerator.



Icemaker-Installed Models



2. TURN ON THE WATER SUPPLY (icemaker and dispenser models)

Turn the water on at the shutoff valve (house water supply) and check for any leaks.



3. PLUG IN THE REFRIGERATOR

On models with an icemaker, before plugging in the refrigerator, make sure the icemaker power switch is set to the O (off) position.



See the grounding information attached to the power cord.

4. PUT THE REFRIGERATOR IN PLACE

Move the refrigerator to its final location.

5. REMOVE THE FRESH FOOD DOOR HANDLE

(For placement in the installation location or reversal of the handles – on some models)

Stainless steel (on some models):

A. REMOVING THE DOOR HANDLE: Loosen the set screws with the 3/32" Allen wrench and remove the handle. NOTE: For Double Door models follow the same procedure on the opposite door.



B. REVERSING THE DOOR HANDLE: •Remove the handle mounting fasteners with a 1/4" Allen wrench and transfer the handle mounting fasteners to the right side.

- Remove and transfer the plug button and logo badge to the left side of the fresh food door.

NOTE: Use a flat plastic edge to prevent damaging the door. Remove any adhesive on the door with a mild detergent. Remove the paper covering on the adhesive backing on the logo badge prior to carefully attaching the badge to the door.

Plastic handle (on some models):

A. REMOVING THE DOOR HANDLE: Slide the handle up on the handle mounting fasteners and remove the handle.



B REVERSING THE DOOR HANDLE:

- Remove the handle mounting fasteners with a 3/8" or 10 mm socket wrench and transfer the handle mounting fasteners to the right side.
- Remove and transfer the plug button and logo badge to the left side of the fresh food door. NOTE: Use a flat plastic edge to prevent damaging the door. Remove any adhesive on the door with a mild detergent. Remove the paper covering on the adhesive backing on the logo badge prior to carefully attaching the badge to the door.

After removing the handle: Move the small plug button from the top right side of the door top and insert it into the hole on the opposite side.



(appearance may vary)

6. REMOVE THE FREEZER DOOR HANDLE

Stainless steel handle:

Loosen the set screws located on the underside of the handle with the 3/32" Allen wrench and remove the handle.

NOTE: If the handle mounting fasteners need to be tightened or removed use a 1/4" Allen wrench.



Plastic handle:

A Slide the handle to the right on the handle mounting fasteners and remove the handle.

NOTE: If the handle mounting fasteners need to be tightened or removed use a 3/8" or 10 mm socket wrench.



(appearance may vary)

Slots on back
of handle

7 ATTACH THE FRESH FOOD DOOR HANDLE

Stainless steel handle:

A Attach the handle to the handle mounting fasteners and tighten the set screws with a 3/32" Allen wrench. NOTE: For Double Door models follow the same procedure on the opposite door.

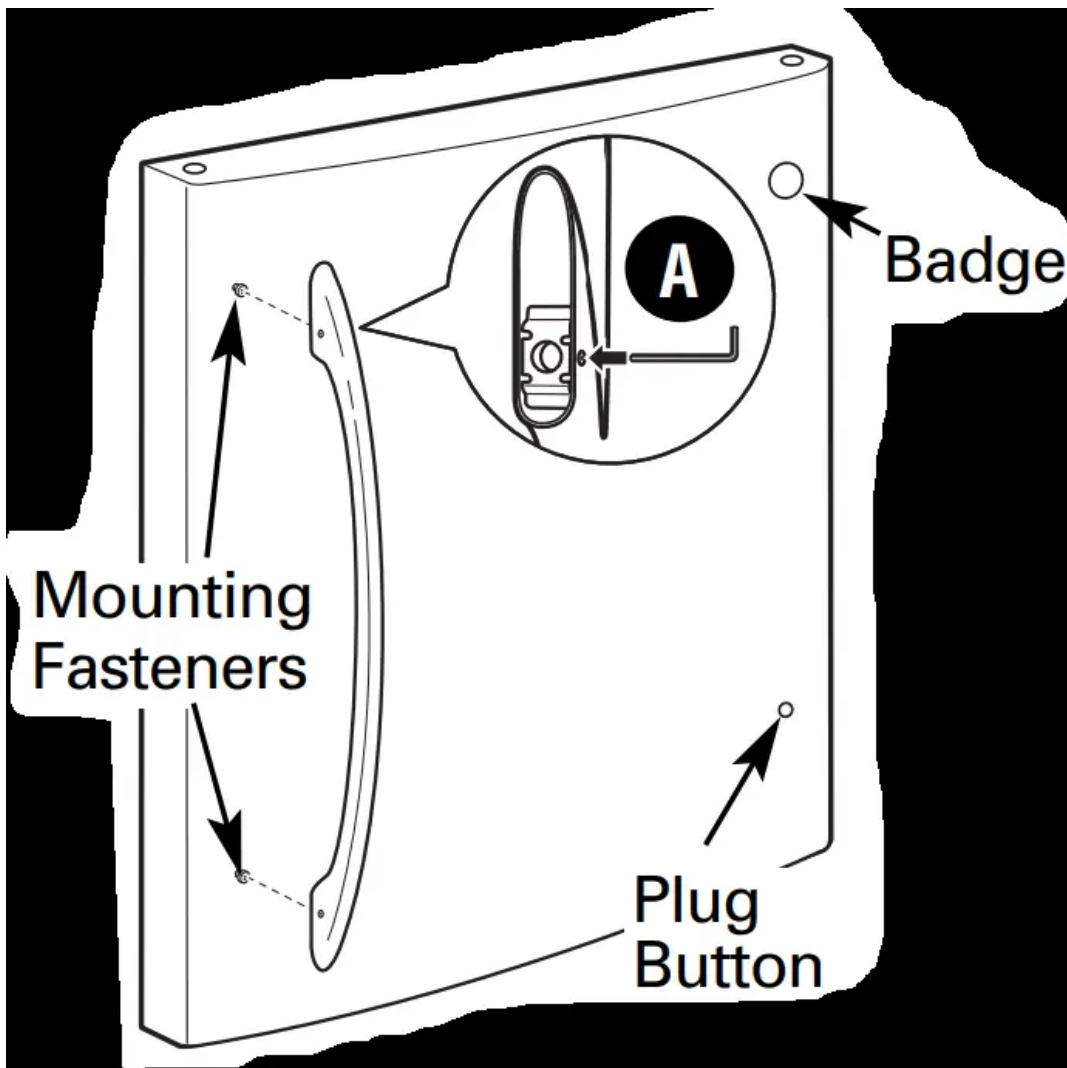

Plastic handle:

A Attach the handle to the handle mounting fasteners by aligning the slots with the handle mounting fasteners.

B Slide it down until it is firmly locked into position.



8 ATTACH THE FREEZER DOOR HANDLE

Stainless steel handle:

A Attach the handle firmly to the mounting fasteners and tighten the set screws on the bottom of the handle with a 3/32" Allen wrench.



Plastic handle:

A Attach the handle to the mounting fasteners by aligning the slots with the mounting fasteners.

B Slide it to the left until it is firmly locked into position.

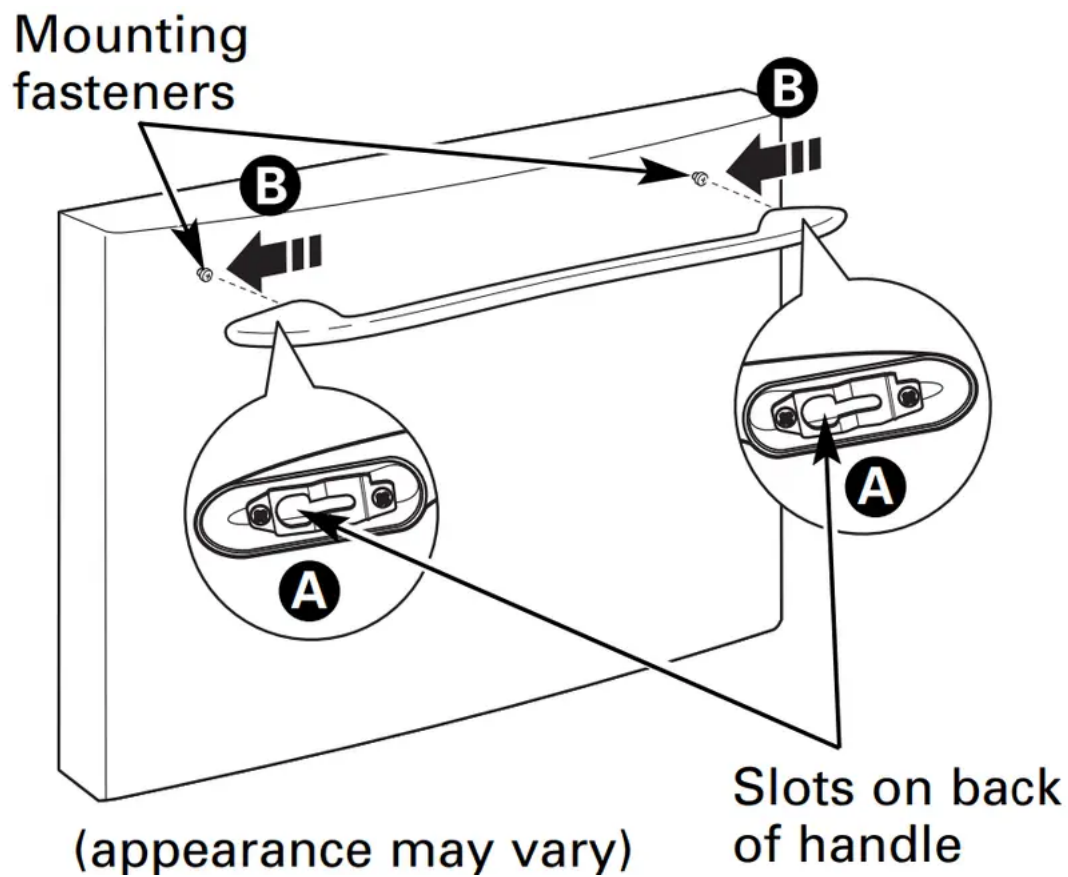

NOTE: A properly locked handle will be centered on the freezer.

9. LEVEL THE REFRIGERATOR

The leveling legs have 3 purposes:

- 1) Leveling legs adjust so the door closes easily when opened about halfway. (Front of the refrigerator should be 1/4" [6 mm] higher than the rear of the refrigerator).
- 2) Leveling legs adjust so the refrigerator is firmly positioned on the floor and does not wobble.
- 3) Leveling legs serve as a stabilizing brake to hold the refrigerator securely in position during operation and cleaning.

A Turn the leveling legs clockwise to raise the refrigerator, counterclockwise to lower it.



CAUTION: To avoid possible personal injury or property damage, the leveling legs must be firmly touching the floor.

B Install the base grille by aligning the prongs on the back of the grille with the holes in the cabinet. Push forward until the grille snaps into place.

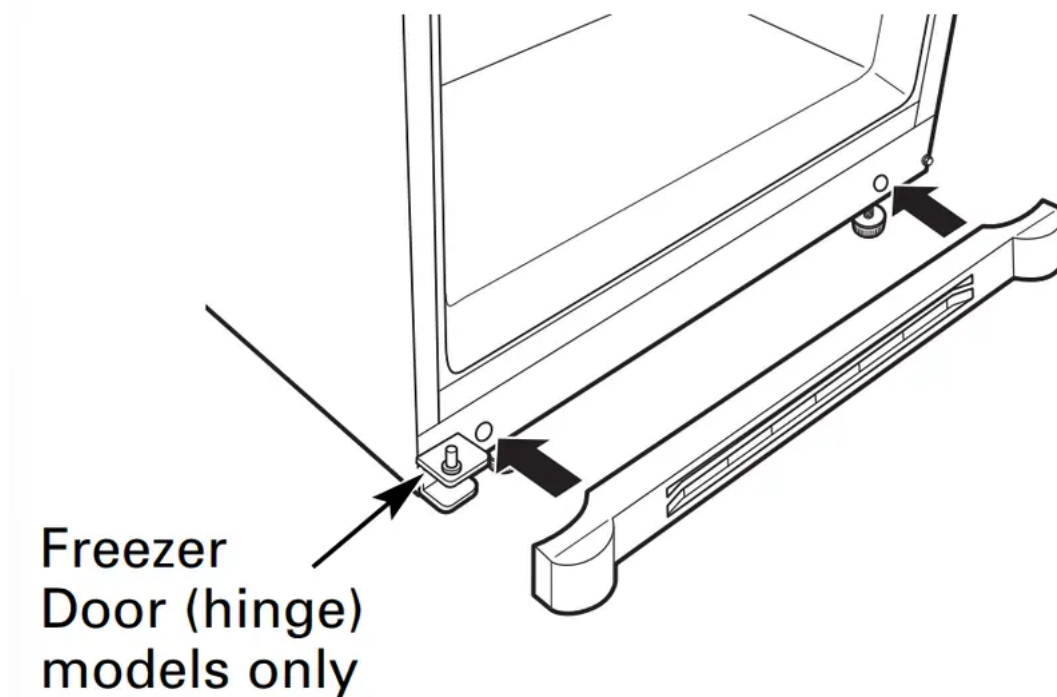

10. SET THE CONTROLS

Set the controls to the recommended setting.



11. REMOVE PACKAGING START ICEMAKER (icemaker models)

- A) Remove all tape, foam and protective packing from shelves and drawers.
- B) Remove the tie downs from the freezer baskets.
- C) Place half width basket onto drawer slides. See About the freezer section for instructions. Set the icemaker power switch to the I (on) position. The icemaker will not begin to operate until it reaches its operating temperature of 15°F (−9°C) or below. It will then begin operation automatically. It will take 2–3 days to fill the ice bin.



NOTE: In lower water pressure conditions, the water valve may turn on up to 3 times to deliver enough water to the icemaker.

REMOVING THE FREEZER DRAWER (on some models)

The freezer drawer can be removed, if needed, to fit through tight areas. Read these instructions completely and carefully.

1. REMOVE THE BASKET

- A** Open the freezer drawer until it stops.
- B** The freezer basket rests on a frame inside the freezer drawer. Lift the basket up at the back.
- C** Lift the front up and lift the entire basket up and out of the drawer.



2. REMOVE THE DRAWER FRONT FROM THE SLIDES

A Remove the Phillips head screw on each side of the railing.

DO NOT remove the hex head screws from the rail assemblies.



B Lift up on both sides of the freezer drawer handle to separate the drawer railings from the rail assemblies.

C Set the drawer front on a nonscratching surface.

D Push the rail assemblies back into locking position.



3. REMOVE THE BASE GRILLE (if needed)

If, after removing the freezer drawer and refrigerator door, the refrigerator will still not fit through a doorway, the base grille can be removed.

A Remove the base grille by grasping it at the bottom and pulling it straight out.



*Two people may be required to complete this procedure.

REPLACING THE FREEZER DRAWER (on some models)

1. ATTACH AND SECURE THE DRAWER FRONT TO THE SLIDES

A Pull out the rail assemblies to the full length on each side of the cabinet.



B Locate the slots on the inside of the rail assemblies near the back.



C Insert the hooks at the back of the drawer railings into the slots on the rail assemblies.

D Lower the front of the drawer, making sure the tabs on the sides of the railings fit into the front slots in the rail assemblies.



E Replace the Phillips head screws on both rail assemblies.



2. REPLACE THE FREEZER BASKET

Replace the lower freezer basket by lowering it into the frame.

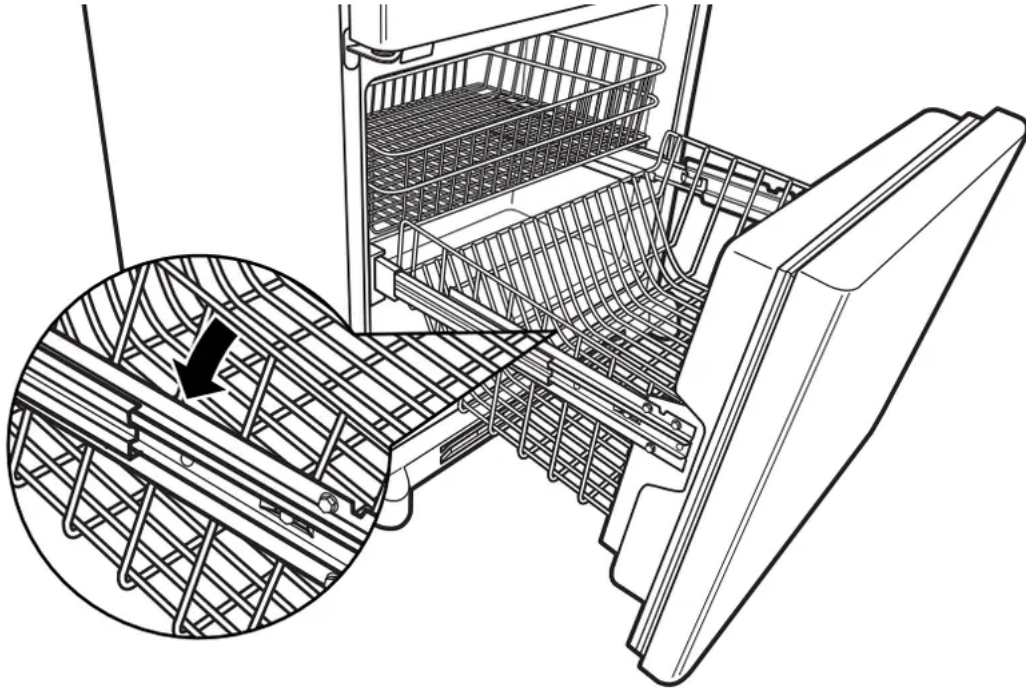

REVERSING THE DOOR SWING (Single Door Refrigerator Models only)

IMPORTANT NOTES

When reversing the door swing:

NOTE: Door swing is not reversible on some stainless steel models.

- Read the instructions all the way through before starting.
- Handle parts carefully to avoid scratching paint.
- Set screws down by their related parts to avoid using them in the wrong places.
- Provide a non-scratching work surface for the doors.

IMPORTANT: Once you begin, do not move the cabinet until door-swing reversal is completed.

These instructions are for changing the hinges from the right side to the left side—if you ever want to change the hinges back to the right side, follow these same instructions and reverse all references to left and right.

- Once door swing is finalized, ensure the logo badge is properly aligned and permanently secured to the door by removing the adhesive cover on the back side.

NOTE: If necessary call Customer Service for a replacement badge.

Unplug the refrigerator from its electrical outlet. Empty all door shelves, including the dairy compartment.

TOOLS YOU WILL NEED



Adjustable Wrench



3/8" and 10 mm Socket Ratchet/Driver



Masking Tape



Putty Knife or Thin-blade Screwdriver



Phillips Screwdriver

1. REMOVE THE REFRIGERATOR DOOR

A Tape the door shut with masking tape.



B Remove the hinge cover on top of the refrigerator door by squeezing it and pulling it up.

C Using a 3/8" or 10 mm socket ratchet/driver, remove the bolts securing the top hinge to the cabinet. Then lift the hinge straight up to free the hinge pin from the socket in the top of the door.



D Remove the tape and tilt the door away from the cabinet. Lift the door off the center hinge pin. Ensure that the white hinge pin thimble remains on the hinge pin or inside door hinge pin hole located in the bottom of the door.



E Set the door on a non-scratching surface with the inside up.

2. REMOVE THE CENTER HINGE PIN

A On models with a freezer door, tape the door shut with masking tape.

B Using an adjustable wrench, remove the center hinge pin.



3. REMOVE THE FREEZER DOOR (freezer door mode)

A Remove the tape and tilt the door away from the cabinet. Lift the door off the bottom hinge pin.
NOTE: There is a plastic washer between the hinge and the top of the freezer door. Do not lose.

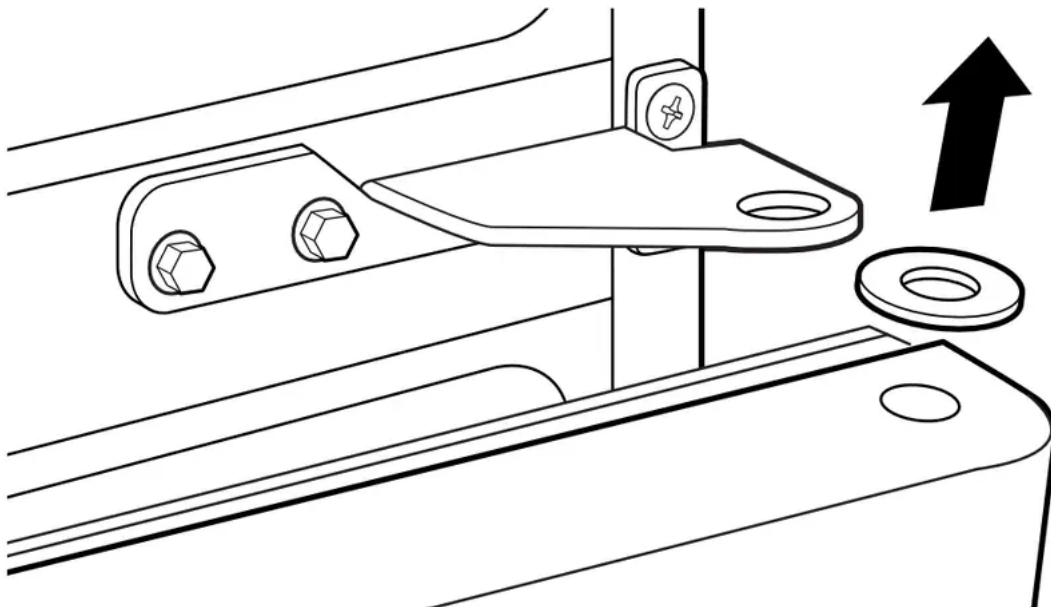

B Set the door on a non-scratching surface with the inside up.

4. REMOVE CENTER HINGE

Using a 3/8" or 10 mm socket ratchet/driver and Phillips head screwdriver, remove the bolts and screws securing the center hinge to the cabinet. Set hinge, bolts, screws, washer (on freezer door models) and hinge pin aside.



On models with a freezer drawer, skip to Step 7.

5. TRANSFER BOTTOM HINGE BRACKET (freezer door models)

A Remove the base grille by grasping it at the bottom and pulling it straight out.



B Using a 3/8" or 10 mm socket ratchet/driver, remove the screws securing the bottom hinge bracket to the cabinet.



C Using an adjustable wrench, remove the hinge pin and washer(s) from the right side of the bracket and install on the left.



D Install the bottom hinge bracket on the left side of the cabinet.

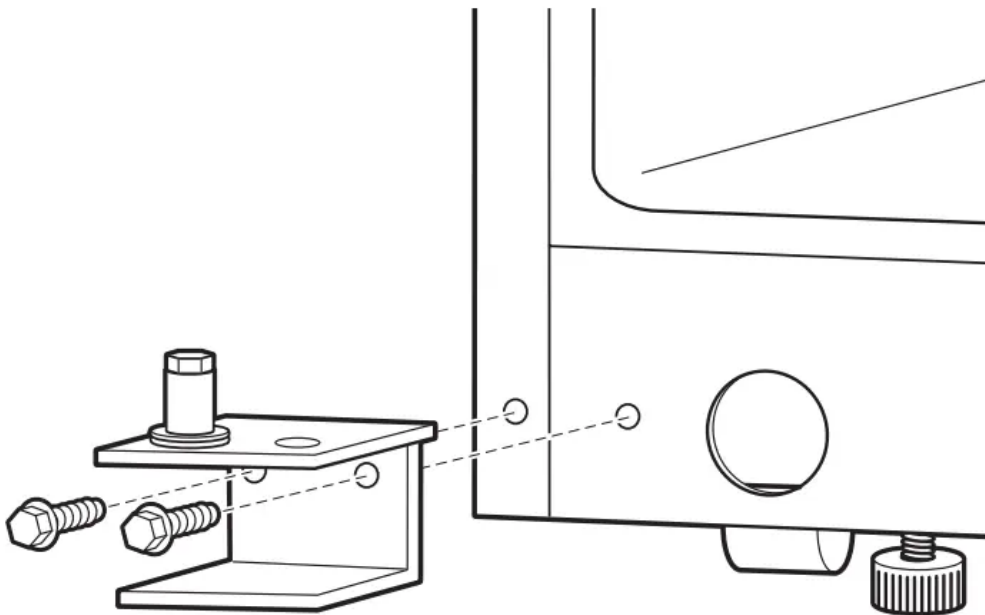

E Replace the base grille by aligning the prongs on the back of the grille with the holes in the cabinet. Push forward until the grille snaps into place.



6. TRANSFER FREEZER DOOR STOP (freezer door models)

A Remove the door stop on right side of the bottom of the freezer door by removing the two screws.

B Move the plastic hinge hole thimble to the opposite hole.

C Install the door stop on the left side.



Bottom of Freezer Door
(Right Side)



Bottom of Freezer Door
(Left Side)

7. INSTALL CENTER HINGE

A Transfer the plug button and screws in the hinge holes on the left side to the right side.

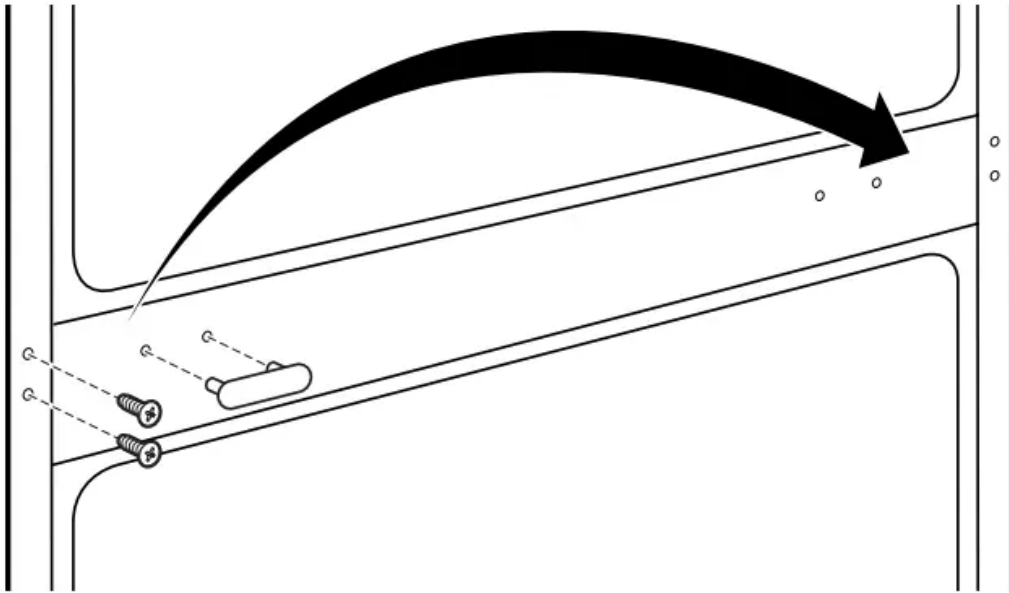

B Install the center hinge on the left side.

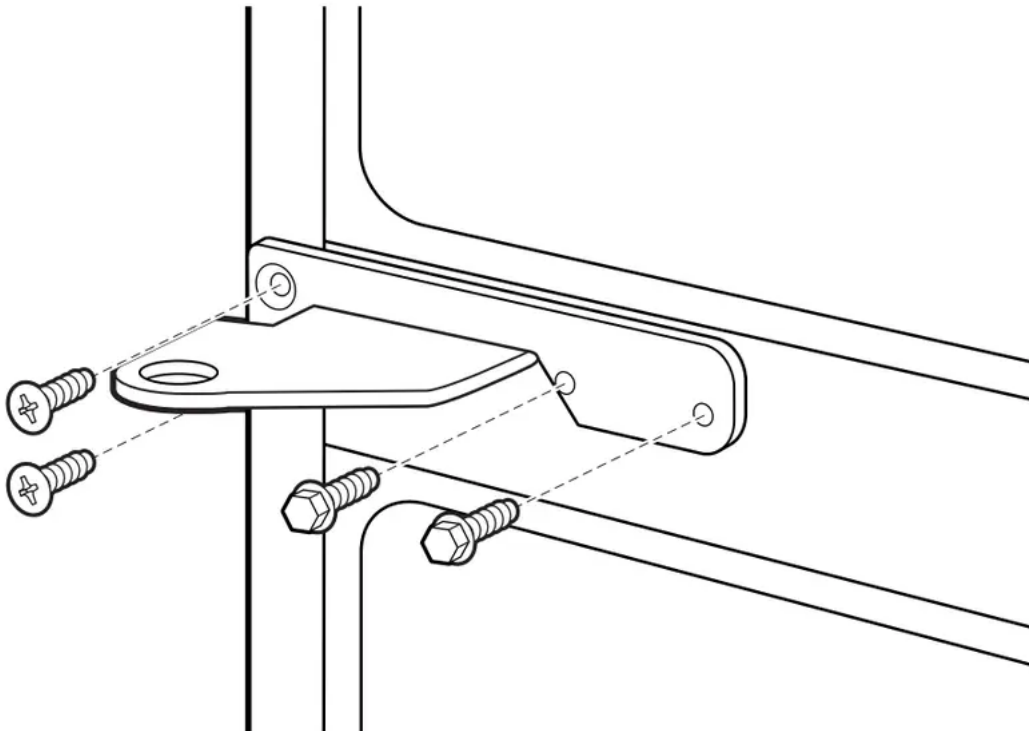

8. HANG THE FREEZER DOOR (freezer door models)

Lower the freezer door onto the bottom hinge pin, then shut the door, making sure to align the door with the cabinet. Make sure the gasket on the door is flush against the cabinet.





9. INSTALL CENTER HINGE PIN

A Install the center hinge pin. NOTE: On models with a freezer door, be sure to put the washer between the top of the freezer door and the bottom of the center hinge.



Freezer Door Models



Freezer Drawer Models

10. TRANSFER REFRIGERATOR DOOR STOP

A Remove the door stop on right side of the bottom of the refrigerator door by removing the two screws.

B Move the plastic hinge hole thimble to the opposite hole.

C Install the door stop on the left side, making sure to line up the screw holes in the door stop with the holes in the bottom of the door.



11. TRANSFER REFRIGERATOR DOOR HANDLE TO RIGHT

Refer to Remove the Fresh Food Door Handle and Attach the Fresh Food Door Handle sections for instructions.

12. REHANG REFRIGERATOR DOOR

A Lower the refrigerator door onto the center hinge pin. Ensure that the white hinge pin thimble is on the center hinge pin or inside door hinge pin hole located in the bottom of the door.



B Insert the top hinge pin into the hinge hole on top of the refrigerator door.

C Make sure the door is aligned with the cabinet. Attach the hinge to the top of the cabinet loosely with the bolts. Make sure the gasket on the door is flush against the cabinet and is not folded. Support the door on the handle side and make sure the door is straight and the gap between the doors is even across the front. While holding the door in place, tighten the top hinge bolts. Replace the hinge cover.



REMOVING THE DOORS (Double Door Refrigerator Models only)

IMPORTANT NOTES

NOTE: Door swing is not reversible.

- Read the instructions all the way through before starting.
- Handle parts carefully to avoid scratching paint.
- Set screws down by their related parts to avoid using them in the wrong places.
- Provide a non-scratching work surface for the doors.

IMPORTANT: Once you begin, do not move the cabinet. These instructions are for removing the doors. **Unplug the refrigerator from its electrical outlet. Empty all door shelves, including the dairy compartment.**

TOOLS YOU WILL NEED



Adjustable Wrench

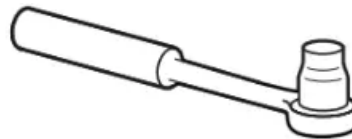

3/8" and 10 mm Socket Ratchet/Driver



Masking Tape

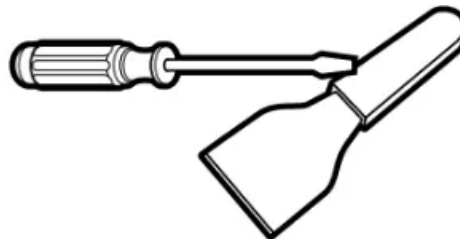

Putty Knife or Thin-blade Screwdriver

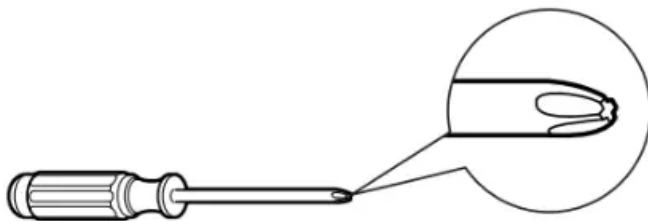

Phillips Screwdriver

PARTS INCLUDED



C Spacer (on some models)

1. REMOVE THE REFRIGERATOR DOORS

A Tape the doors shut with masking tape.



B Remove the screw securing each hinge cover, lift the hinge cover and place to the side on top of the refrigerator. Carefully disconnect the wire connector and remove the screw securing the ground wire.

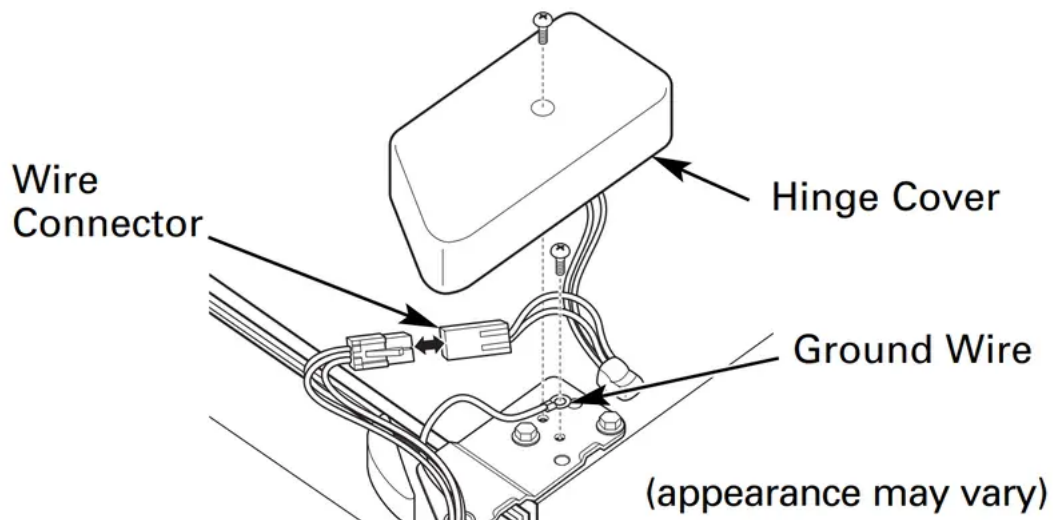

C Using a 3/8" or 10 mm socket ratchet/driver, remove the bolts securing the top hinge to the cabinet. Then lift the hinge straight up to free the hinge pin from the hinge pin hole in the top of the door. Carefully remove the wires from the hinge pin through the slot.



D Remove the tape and tilt the door away from the cabinet. Lift the door off the center hinge pin. Ensure that the white hinge pin thimble remains on the center hinge pin or inside door hinge pin hole located in the bottom of the door.



E Set the door on a non-scratching surface with the inside up.

2. REMOVE CENTER HINGE

Using a 3/8" or 10 mm socket ratchet/driver and Phillips head screwdriver, remove the bolts and screw securing the center hinge to the cabinet. Set hinge, bolts, and screw aside.



3 REMOVE OPPOSITE DOOR

Follow the same procedure on the opposite door.

4 REMOVE FREEZER DRAWER

Refer to the Removing the Freezer Drawer section for instructions.

REPLACING THE DOORS (Double Door Refrigerator Models only)

1. INSTALL CENTER HINGE

Install the center hinge on each side.



2. REHANG REFRIGERATOR DOORS

A Lower the refrigerator door onto the center hinge pin. Ensure that the white hinge pin thimble is on the center hinge pin or inside door hinge pin hole located in the bottom of the door.



B Securely tape the door shut with masking tape or have a second person support the door.

C Route wires through top hinge pin slot. Insert the top hinge pin into the hinge hole on top of the refrigerator door. Make sure the door is aligned with the cabinet and opposite door. Attach the hinge to the top of the cabinet loosely with the bolts.

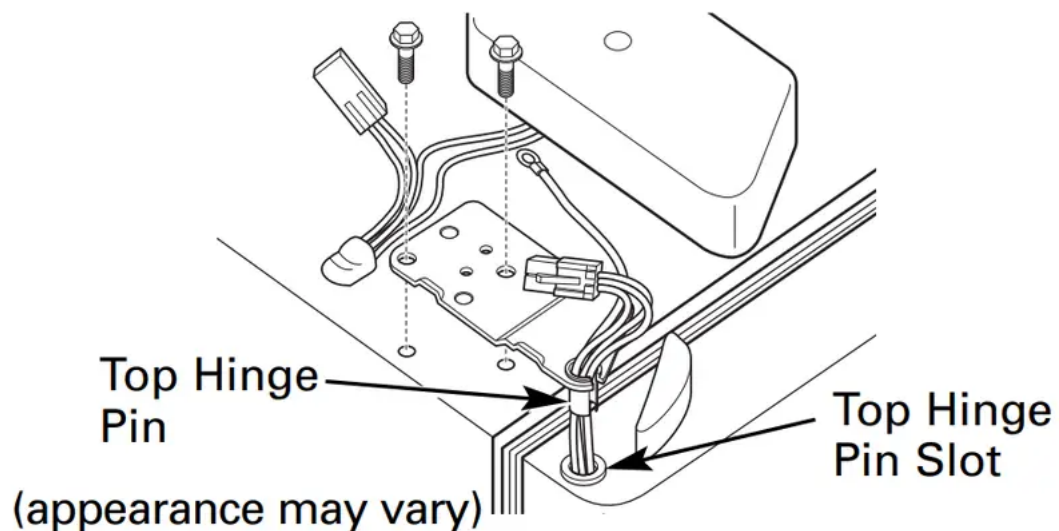

D Reconnect the wire connector and reconnect the ground wire using the screw removed earlier. Ensure that the wire connector is fully engaged.

IMPORTANT: The ground wire must be reinstalled to ensure a proper ground.



E Make sure the gasket on the door is flush against the cabinet and is not folded. Make sure the door is straight and the gap between the doors is even across the front. While holding the aligned door in place, tighten the top hinge bolts. Replace the hinge cover and screw.



3. REPLACE OPPOSITE DOOR

Follow the same procedure on the opposite door.

4. ALIGN DOUBLE DOORS

If the top of the doors are uneven, first try to raise the lowest door by turning the leveling leg on the same side as the door until the doors are even. If the unit rocks, re-adjust the leveling legs to the extent that the unit is stable.



If the doors remain uneven, use a C spacer to align the doors. While lifting the door on the hinge side with one hand, insert a C spacer with pliers. Continue to add C spacers until the doors are even.



5. REPLACE FREEZER DRAWER

Refer to the Replacing the Freezer Drawer section for instructions.

INSTALLING THE WATER LINE (ICEMAKER MODELS)

1. SHUT OFF THE MAIN WATER SUPPLY

Turn on the nearest faucet long enough to clear the line of water.

2. CHOOSE THE VALVE LOCATION

Choose a location for the valve that is easily accessible. It is best to connect into the side of a vertical water pipe. When it is necessary to connect into a horizontal water pipe, make the connection to the top or side, rather than at the bottom, to avoid drawing off any sediment from the water pipe.



3. DRILL THE HOLE FOR THE VALVE

Drill a 1/4" hole in the water pipe (even if using a self-piercing valve), using a sharp bit. Remove any burrs resulting from drilling the hole in the pipe.

Take care not to allow water to drain into the drill. Failure to drill a 1/4" hole may result in reduced ice production or smaller cubes.

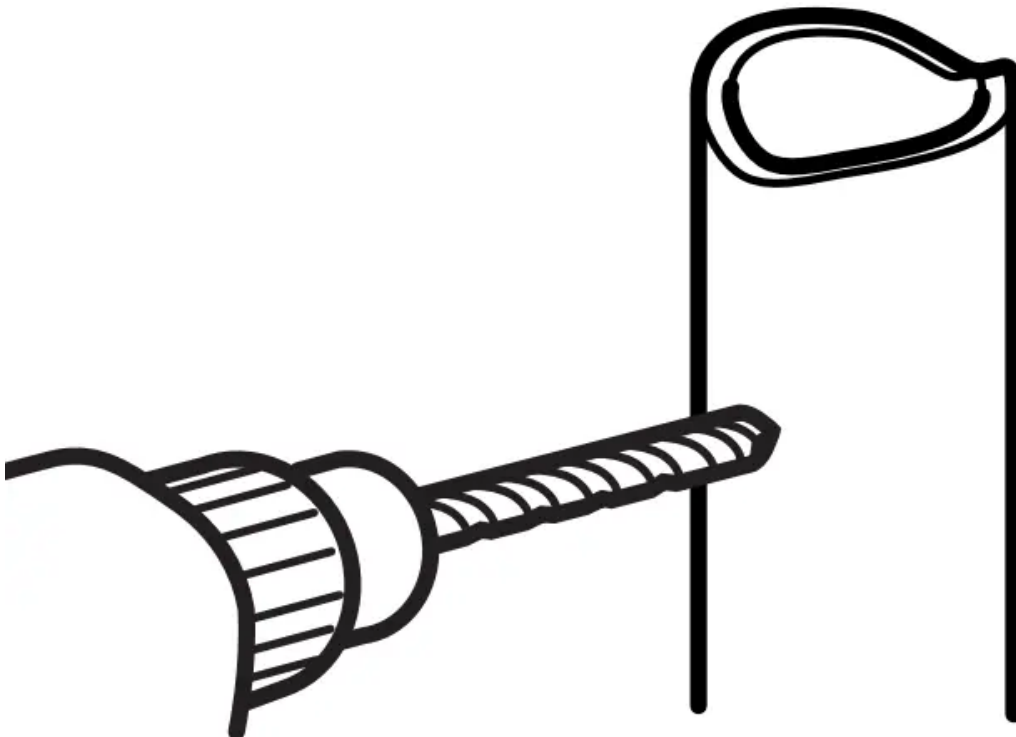

4. FASTEN THE SHUTOFF VALVE

Fasten the shutoff valve to the cold water pipe with the pipe clamp.



NOTE: Commonwealth of Massachusetts Plumbing Codes 248CMR shall be adhered to. Saddle valves are illegal and use is not permitted in Massachusetts. Consult with your licensed plumber.

5. TIGHTEN THE PIPE CLAMP

Tighten the clamp screws until the sealing washer begins to swell.

NOTE: Do not overtighten or you may crush the tubing.

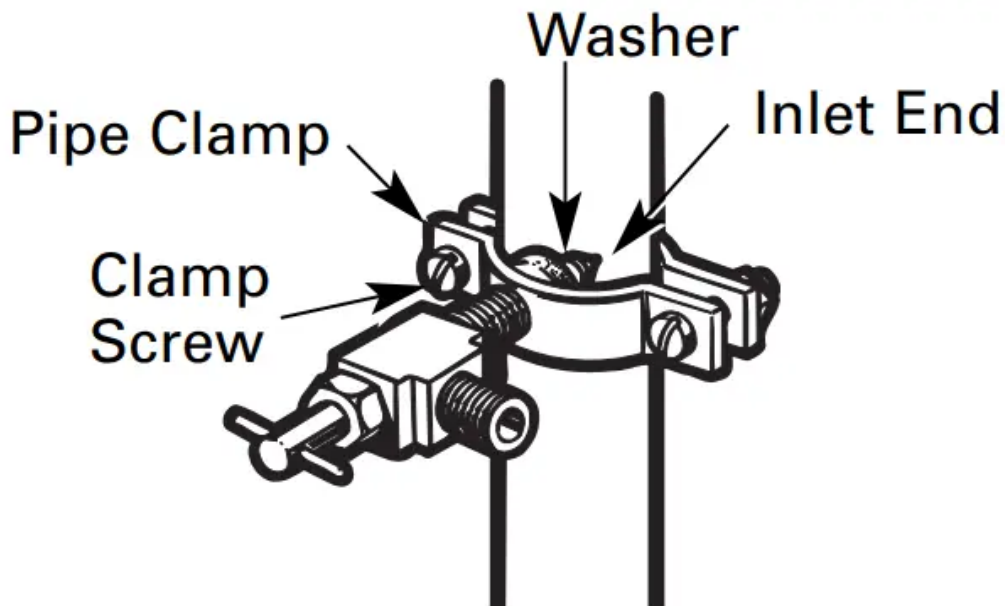

6. ROUTE THE TUBING

Route the tubing between the cold water line and the refrigerator. Route the tubing through a hole drilled in the wall or floor (behind the refrigerator or adjacent base cabinet) as close to the wall as possible. **NOTE:** Be sure there is sufficient extra tubing (about 8' [2.4 m] coiled into 3 turns of about 10" [25 cm] diameter) to allow the refrigerator to move out from the wall after installation.

7. CONNECT THE TUBING TO THE VALVE

Place the compression nut and ferrule (sleeve) for copper tubing onto the end of the tubing and connect it to the shutoff valve. Make sure the tubing is fully inserted into the valve. Tighten the compression nut securely.

For plastic tubing from a GE SmartConnect™ Refrigerator Tubing kit, insert the molded end of the tubing into the shutoff valve and tighten compression nut until it is hand tight, then tighten one additional turn with a wrench. Overtightening may cause leaks.



NOTE: Commonwealth of Massachusetts Plumbing Codes 248CMR shall be adhered to. Saddle valves are illegal and use is not permitted in Massachusetts. Consult with your licensed plumber

8. FLUSH OUT THE TUBING

Turn the main water supply on and flush out the tubing until the water is clear. Shut the water off at the water valve after about one quart (1 liter) of water has been flushed through the tubing.



To complete the installation of the refrigerator, go back to Step 1 in Installing the Refrigerator.

CARE AND CLEANING

Cleaning the Outside

The door handles and trim. Clean with a cloth dampened with soapy water. Dry with a soft cloth. Do not use wax on the door handles and trim.

Keep the outside clean. Wipe with a clean cloth lightly dampened with kitchen appliance wax or mild liquid dish detergent. Dry and polish with a clean, soft cloth.

- Do not wipe the refrigerator with a soiled dish cloth or wet towel. These may leave a residue that can erode the paint.
- Do not use scouring pads, powdered cleaners, bleach or cleaners containing bleach because these products can scratch and weaken the paint finish.

The stainless steel panels and door handles.

Stainless steel (on some models) can be cleaned with a commercially available stainless steel cleaner. A spray-on stainless steel cleaner works best.

Do not use appliance wax or polish on the stainless steel.

Cleaning the Inside

To help prevent odors, leave an open box of baking soda in the refrigerator and freezer compartments.

Unplug the refrigerator before cleaning. If this is not practical, wring excess moisture out of sponge or cloth when cleaning around switches, lights or controls.

- Use an appliance wax polish on the inside surface between the doors.
- Use warm water and baking soda solution— about a tablespoon (15 ml) of baking soda to a quart (1 liter) of water. This both cleans and neutralizes odors. Rinse and wipe dry.
- After cleaning the door gaskets, apply a thin layer of petroleum jelly to the door gaskets at the hinge side. This helps keep the gaskets from sticking and bending out of shape.

NOTE

- Avoid cleaning cold glass shelves with hot water because the extreme temperature difference may cause them to break. Handle glass shelves carefully. Bumping tempered glass can cause it to shatter.
- Do not wash any plastic refrigerator parts in the dishwasher

Behind the Refrigerator

Be careful when moving the refrigerator away from the wall. All types of floor coverings can be damaged, particularly cushioned coverings and those with embossed surfaces.

Pull the refrigerator straight out and return it to position by pushing it straight in.

Moving the refrigerator in a side direction may result in damage to the floor covering or refrigerator.

NOTE: When pushing the refrigerator back, make sure you don't roll over the power cord or icemaker supply line (on some models)

Preparing for Vacation

For long vacations or absences, remove food and unplug the refrigerator. Move the freezer control to the 0 (off) position, and clean the interior with a baking soda solution of one tablespoon (15 ml) of baking soda to one quart (1 liter) of water. Leave the doors open.

Set the icemaker power switch to the O (off) position and shut off the water supply to the refrigerator.

If the temperature can drop below freezing, have a qualified servicer drain the water supply system (on some models) to prevent serious property damage due to flooding.

Preparing to Move

Secure all loose items such as base grille, shelves and drawers by taping them securely in place to prevent damage.

When using a hand truck to move the refrigerator, do not rest the front or back of the refrigerator against the hand truck. This could damage the refrigerator. Handle only from the sides of the refrigerator.

NOTE: Be sure the refrigerator stays in an upright position during moving

Replacing the light bulbs

Turning the control to the 0 (off) position does not remove power to the light circuit.

Refrigerator Lights

CAUTION: Light bulbs may be hot.

1. Unplug the refrigerator.
2. The bulbs are located at the top of the refrigerator compartment behind the controls. To remove the light shield, grasp the shield at the back and pull out to release the tabs at the back.
3. Rotate the shield down and then forward to release the tabs at the front of the shield.
4. After replacing with an appliance bulb of the same or lower wattage, replace the shield.
5. Plug the refrigerator back in.

Freezer Light

CAUTION: Light bulbs may be hot

1. Unplug the refrigerator.
2. The bulb is located at the top of the freezer inside a light shield. To remove the shield, grasp the shield at the back and pull out to release the tabs at the back.
3. Rotate the shield down and then forward to release the tabs at the front of the shield.
4. After replacing with an appliance bulb of the same or lower wattage, replace the shield.
5. Plug the refrigerator back in.

TROUBLESHOOTING

Normal operating sounds.

HUMMM...WHOOSH...

- The new high efficiency compressor may run faster and longer than your old refrigerator and you may hear a high-pitched hum or pulsating sound while it is operating.
- You may hear a whooshing sound when the doors close. This is due to pressure equalizing within the refrigerator.



- You may hear the fans spinning at high speeds. This happens when the refrigerator is first plugged in, when the doors are opened frequently or when a large amount of food is added to the refrigerator or freezer compartments. The fans are helping to maintain the correct temperatures.
- The fans change speeds in order to provide optimal cooling and energy savings.

CLICKS, POPS, CRACKS and SNAPS

- You may hear cracking or popping sounds when the refrigerator is first plugged in. This happens as the refrigerator cools to the correct temperature.
- The freezer control will click when starting or stopping the compressor.
- Defrost timer snapping in and out of the defrost cycle.
- Expansion and contraction of cooling coils during and after defrost can cause a cracking or popping sound.
- On models with an icemaker, after an icemaking cycle, you may hear the ice cubes dropping into the ice bucket.
- On models with a dispenser, during water dispense, you may hear the water lines move at initial dispense and after dispenser button is released.

WATER SOUNDS

- The flow of refrigerant through the freezer cooling coils may make a gurgling noise like boiling water.
- Water dropping on the defrost heater can cause a sizzling, popping or buzzing sound during the defrost cycle.
- A water dripping noise may occur during the defrost cycle as ice melts from the evaporator and flows into the drain pan.
- Closing the door may cause a gurgling sound due to pressure equalization.

Before you call for service...



Problem	Possible Causes
Refrigerator does not operate	Refrigerator in defrost cycle.
	Control in 0 (off) position.
	Refrigerator is unplugged.
	The fuse is blown/circuit
Vibration or rattling	Leveling legs need adjusting.
Motor operates for long periods or cycles on and off frequently. (Modern refrigerators with more storage space and a larger freezer require more operating time. They start and stop often to maintain even temperatures.)	Normal when refrigerator is first plugged in.
	Often occurs when large amounts of food are placed in refrigerator.
	Door left open.
	Hot weather or frequent door openings.
	Temperature control set at the coldest setting.
	Grille and condenser need cleaning.
	TurboCool function has been activated.
Refrigerator or freezer compartment too warm	Temperature controls not set cold enough.
	Warm weather or frequent door openings.
	Door left open.
Frost or ice crystals on frozen food (frost within package is normal)	Door left open.
	Too frequent or too long door openings.



Problem	Possible Causes
Frequent "buzzing" sound	Icemaker power switch is in the <i>I (on)</i> position, but the water supply to the refrigerator has not been connected.
Small or hollow cubes	Water filter clogged.
Automatic icemaker (on some models) does not work	Icemaker power switch is not on.
	Water supply turned off or not connected.
	Freezer compartment too warm.
	Piled up cubes in the storage bin cause the icemaker
	to shut off.
	Ice cubes stuck in icemaker.
	(Green power light on icemaker blinking.)
	Icemaker light is not lit.
Ice cubes have odor/taste	Food transmitting odor/taste to ice cubes.
	Interior of refrigerator needs cleaning.
Slow ice cube freezing	Door left open.
	Freezer control not set cold enough.



Problem	Possible Causes
Refrigerator has odor	Foods transmitting odor to refrigerator.
	Interior needs cleaning.
Moisture forms on outside of refrigerator	Not unusual during periods of high humidity.
Moisture collects inside (in humid weather, air carries moisture into refrigerator when doors are opened)	Too frequent or too long door openings.
Refrigerator or freezer compartment light does not work	No power at outlet.
	Light bulb burned out or loose.
Door/drawer does not close by itself	Leveling legs need adjusting.
Freezer door/drawer pops open when refrigerator door is closed	This is normal if, after popping open, the freezer door/drawer closed on its own.
Hot air from bottom of refrigerator	Normal air flow cooling motor. In the refrigeration process, it is normal that heat is expelled in the area under the refrigerator. Some floor coverings will discolor at the normal and safe temperatures.
	Food too close to the air vent at the back of the refrigerator.



Problem	Possible Causes
Food freezing in the refrigerator	
	Refrigerator control is set too cold.
Orange glow in the freezer	Defrost heater is on.
Water has poor taste/odor	Water dispenser has not been used for a long time.
Water in first glass is warm	Normal when refrigerator is first installed.
	Water dispenser has not been used for a long time.
	Water system has been drained.
Water dispenser does not work	Water supply line turned off or not connected.
	Water filter clogged.
	Air may be trapped in the water system.
Water spurting from dispenser	Newly-installed filter cartridge.
Water is not dispensed but icemaker is working	Water in reservoir is frozen because the controls are set too cold.
No water or ice cube production	Supply line or shutoff valve is clogged.
	Water filter clogged.
	Filter cartridge not properly installed.



Problem	Possible Causes
Water is leaking from dispenser	<p>Glass not being held under the dispenser long enough after button is released.</p> <p>Air may be present in the water line system, causing water to drip after being dispensed.</p>
My display is showing 	TurboCool function is activated.
Water filter indicator light changed color	This is normal.
Water filter indicator light remains red even after replacing the water filter	Water filter indicator must be reset.
Water filter indicator light is not lit	This is normal. This light will turn orange to tell you that you need to replace the filter soon. The filter cartridge should be replaced when the replacement indicator light turns red.
Handle is loose / handle has a gap	Handle needs adjusting.
Refrigerator beeping	This is the door alarm.
Control setting is not lit	On some models, the light bulbs at the top of the refrigerator compartment light up when the temperature control settings are changed.

Problem	Possible Causes
Refrigerator doors are not even (on Double Door models only)	Doors need realigning.

Warning

This content is compiled from multiple sources and is provided for reference purposes only. It may not be complete or fully applicable to all situations. If you are unable to resolve your issue, please contact the product manufacturer or an authorized service provider for official support.

