

## Control panel

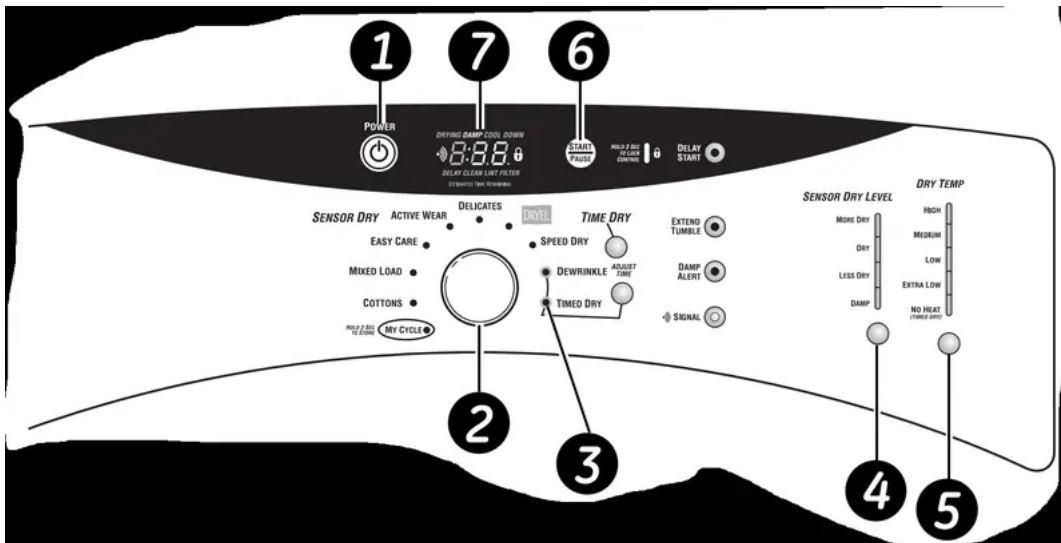

### 1. Power

Press to “wake up” the display. If the display is active, press to put the dryer in the standby mode.

**NOTE:** Pressing POWER does not disconnect the appliance from the power supply.

### 2. Dry Cycles

The dry cycle controls the length and tumble speed of the drying process. The chart below will help you match the dry setting with the loads.

#### Sensor Cycles

- **COTTONS** For cottons and most linens.
- **MIXED LOAD** For loads consisting of cottons and poly-blends.
- **EASY CARE** For wrinkle-free and permanent press items.
- **ACTIVE WEAR** Clothing worn for active sports exercise and some casual wear. Fabrics include new technology finishes and stretch fibers such as Spandex.
- **DELICATES** For lingerie and special-care fabrics.
- **DRYEL™** Designed for use with the DRYEL™ “dry clean only” fabric care system. See product package for directions. For questions or issues related to use and performance of DRYEL™, see the Website at: [www.dryel.com](http://www.dryel.com).
- **SPEED DRY** For small loads that are needed in a hurry, such as sports or school uniforms. Can also be used if the previous cycle left some items damp, such as collars or waistbands.

## Timed Dry Cycles

- **DEWRINKLE** For removing wrinkles from items that are dry or slightly damp. This cycle is not recommended for delicate fabrics.
- **WARM UP** Provides 10 minutes of warming time to warm up clothes.
- **AIR FLUFF** Use this feature to tumble items without heat.
- **My Cycle** (on some models) Press to use, create or modify custom dry cycles.

### 3. Timed Dry

Use to set your own dry time. TIMED DRY is also recommended for small loads. To use TIMED DRY:

1. Turn dry cycle dial to TIMED DRY.
2. Select the drying time by pressing the + and – buttons.
3. Select the DRY TEMP.
4. Close the door.
5. Press START.

### 4. Sensor Dry Level

The sensor continuously monitors the amount of moisture in the load. When the moisture in your clothes reaches your selected dry level, the dryer will stop.

- **MORE DRY** Use for heavy or mixed type of fabrics.
- **DRY** Use for normal dryness level suitable for most loads. This is the preferred cycle for energy saving.
- **LESS DRY** Use for lighter fabric (ideal for ironing).
- **DAMP** For leaving items partially damp.

### 5. Dry Temp

You can change the temperature of your dry cycle.

---

## ANTI-BACTERIAL

This option may only be used with COTTONS or MIXED LOAD cycles. This option reduces on some models) certain types of bacteria by 99.9%, including: Staphylococcus aureus, Pseudomonas aeruginosa and Klebsiella pneumoniae\*. The anti-bacterial process occurs when high heat is used during a portion of this drying cycle.

**NOTE:** Do not use this cycle on delicate fabrics.

\* The Anti-Bacterial Cycle is Certified by NSF International (formerly National Sanitation Foundation) to NSF Protocol P154 Sanitization Performance of Residential Clothes Dryers.



## NSF Protocol P154 Sanitization Performance of Residential Clothes Dryers

- **HIGH** For regular to heavy cottons.
- **MEDIUM** For synthetics, blends and items labeled permanent press.
- **LOW** For delicates, synthetics and items labeled Tumble Dry Low.
- **EXTRA LOW** For lingerie and special-care fabrics.
- **NO HEAT** (on some models) Can only be used with TIMED DRY.

### 6. START

Press to start a dry cycle. If the dryer is running, press it once and it will pause the dryer. Press it again to restart the dry cycle.

#### ***My Cycle (on some models)***

Set up your favorite combination of settings and save them here for one touch recall. These custom settings can be set while a cycle is in progress.

*To store a MY CYCLE combination of settings:*

1. Select your drying cycle.
2. Change DRY TEMP and SENSOR DRY LEVEL settings to fit your needs.
3. Select any drying OPTIONS you want.
4. Press and hold the  pad for three seconds to store your selection. A beep will sound and the pad will light up.

*To recall your stored MY CYCLE combination:*

Press the MY CYCLE button before drying a load.

*To change your stored MY CYCLE combination:*

Follow steps 1–4 in “To store a MY CYCLE combination of settings”.

### 7. CLEAN LINT FILTER” (message)

(This message represents only a reminder.)

After the POWER button is pressed, the “CLEAN LINT FILTER” message could appear if the previous cycle was not finished.

This message will disappear after the START button is pressed. Even though you have already cleaned the filter (before or after the POWER button has been pressed), the “CLEAN LINT FILTER” message will still be displayed until the START button is activated.

## Operating Instructions

### Cycle options

#### Extend Tumble



Minimizes wrinkles by adding approximately minutes of no-heat tumbling after clothes are dry. The beeper will sound every minutes to remind you to remove the clothes. The **ESTIMATED TIME REMAINING** display will show **00**.

#### Damp Alert (on some models)



This option causes the dryer to beep when clothes have dried to a damp level. Remove items that you wish to hang dry. The **DAMP ALERT** will only beep when this option is selected.

Removing clothes and hanging them when they are damp can reduce the need to iron some items.

#### Signal



Alerts you that the cycle is complete.

The beeper will continue to sound every two minutes for the next 6 minutes, until the clothes have been removed. The clothes should be removed when the beeper goes off so wrinkles don't set in.

Press SIGNAL to select low, medium or high volume, or to turn the beeper off.

#### Delay Start



Use to delay the start of your dryer.

1. Choose your dry cycle and any options.
2. Press DELAY START. You can change the delay time in 1 hour increments using the + or – arrow pads.
3. Press the START pad to start the countdown.

The countdown time will be shown in the ESTIMATED TIME REMAINING display.

**NOTES:**

- If the door is opened while the dryer is in DELAY, the countdown time will not restart unless the door is closed and START has been pressed again.
- You can delay the start of a dry cycle up to 18 hours for model DHDVH52

**Lock**

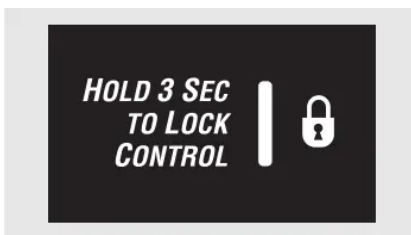

You can lock the controls to prevent any selections from being made. Or you can lock the controls after you have started a cycle.

Children cannot accidentally start the dryer by touching pads with this option selected.

To lock the dryer, press and hold the lock icon for 3 seconds. To unlock the dryer, press and hold the lock icon for 3 seconds.

The icon of the lock next to the timer will light up when the controls are locked.

**Estimated Time Remaining**

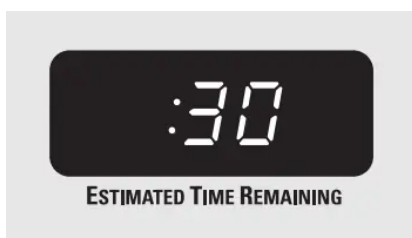

Displays the approximate time remaining until the end of the cycle.

As the cycle begins, you will see an initial approximate total cycle time in the display.

Then lights will “race” in the display. This means the dryer is continuously monitoring the amount of moisture in the load.

The lights will continue until the dryer senses a low level of moisture in the load. At that point, the dryer will calculate and display the approximate time remaining

### **My Cycle (on some models)**



To save a favorite cycle, set the desired settings and hold down the MY CYCLE button for 3 seconds. A beep will sound to indicate the cycle has been saved.

To use your custom cycle, press the MY CYCLE button before drying a load.

To change the saved cycle, set the desired settings and hold down the MY CYCLE button for 3 seconds.

## Dryer features

**Drum Lamp** Before replacing the light bulb, be sure to unplug the dryer power cord or disconnect the dryer at the household distribution panel by removing the fuse or switching off the circuit breaker. Reach above dryer opening from inside the drum. Remove the bulb and replace with the same size bulb.

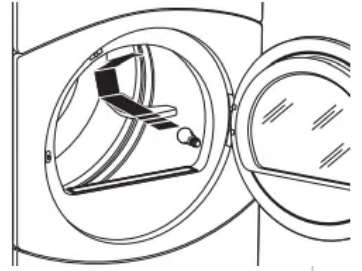

### Drying Rack (on some models)

A handy drying rack may be used for drying delicate items such as washable sweaters. Place items flat on the drying rack and block such items as wool sweaters and delicate fabrics. Dry with low heat.

To install the drying rack, pull up the lint filter slightly. Insert the drying rack into the slots, then push the filter back down.

#### NOTE:

- The drying rack must be used with the TIMED DRY or RACK DRY (on some models) cycles.
- Do not use this drying rack when there are other clothes in the dryer.

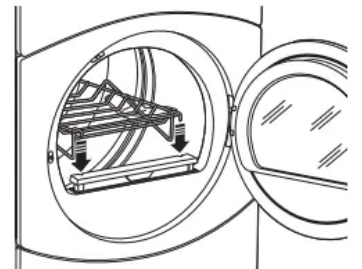

## Reversing the door swing

### IMPORTANT NOTES:

- Read the instructions all the way through before starting.
- Handle parts carefully to avoid scratching paint.
- Set screws down by their related parts to avoid using them in the wrong places.
- Provide a non-scratching work surface for the doors.
- Normal completion time to reverse the door swing is 30–60 minutes.

**IMPORTANT:** Once you begin, do not move the cabinet until door-swing reversal is completed.

These instructions are for changing the hinges from the right side to the left side—if you ever want to switch them back to the right side, follow these same instructions and reverse all references to the left and right.

### 1. TOOLS YOU WILL NEED



Adjustable Crescent Wrench



Phillips Head Screwdriver

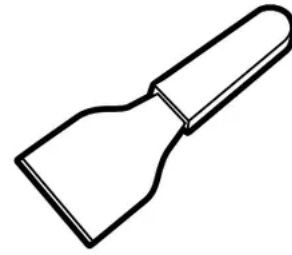

Putty Knife or  
Thin-Blade  
Screwdriver

## 2. DOOR PARTS

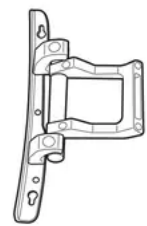

Hinge Assembly



Hinge  
Cover

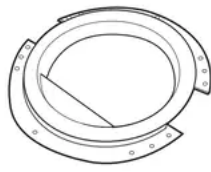

Plastic Cover



Large Tapping  
Screw (#10) - 6



Tapping Screw (#8) - 2



Machine Screw (#8) - 6



Nut (#8) - 2



Washer - 2

## 3. STEP-BY-STEP INSTRUCTIONS

## Before You Start

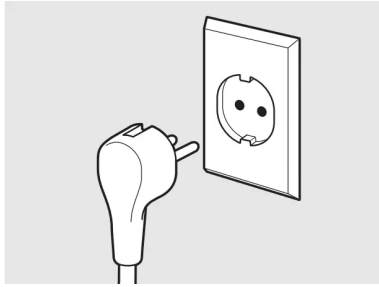

1. Unplug the dryer from its electrical outlet.

## Remove Door Assembly

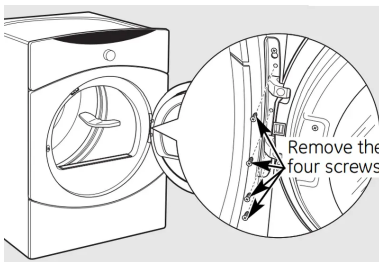

2. Open the door to approximately 90 degrees. Remove the 4 screws starting from the bottom to the top. Make sure the door is supported while removing the screws.

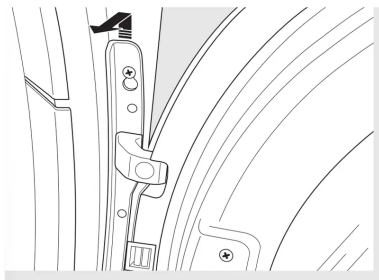

3. Loosen the top screw as shown. Unhook the door by lifting and pulling as shown by the arrows.

4. Lay the door down on a soft protected flat surface so that the inner part faces upward (door resting on the handle side).

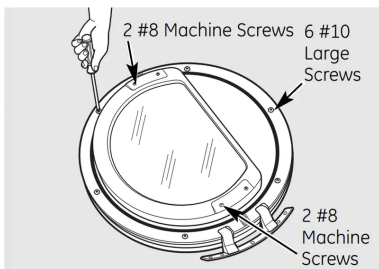

5. Remove the 6 large tapping screws (#10) located around the perimeter of the door outlining the gasket, and the 2 machine screws (#8) on the hinge side.

6. With the screws removed, turn the door over and separate the silver cover part of the door from the door frame and set aside.

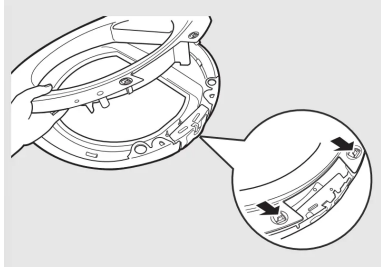
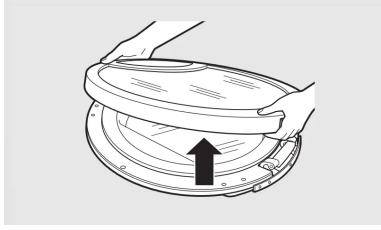

7. Unlock the 4 tabs on the plastic cover and separate the plastic cover from the frame.

**NOTE:** Disregard the “DO NOT REMOVE” label on the plastic cover.

### **Remove Hinge**

**IMPORTANT:** Note the location of the hinge (left or right) before removing

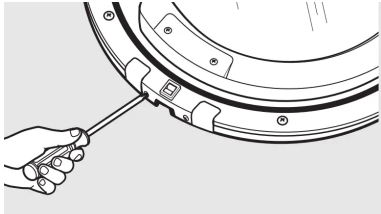

8. With the door frame part of the door laid down on a protected soft surface, remove the hinge cover by removing the 2 tapping screws (#8) that fasten it to the frame. The hinge cover is located at the opposite side of the hinge assembly.

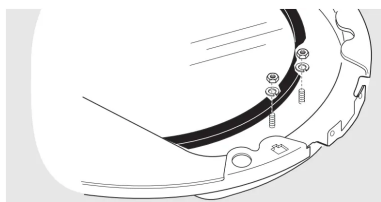

9. Remove the 2 nuts, washers and the 2 machine screws (#8).

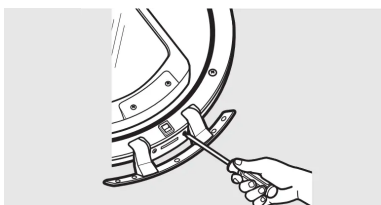

10. Remove the hinge assembly by removing the 2 machine screws (#8) that fasten it to the frame. Pull the hinge assembly out and set it aside.

### **Reinstall Hinge Assembly**

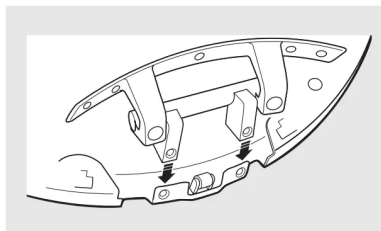

11. Place the hinge assembly in the opposite side of the door. Align the hinge holes with the door holes.

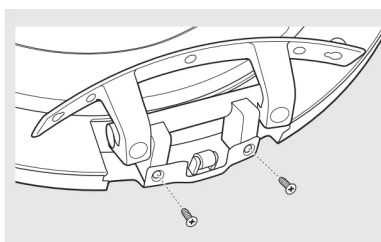

12. Loosely fasten the hinge assembly to the edge using 2 machine screws (#8).

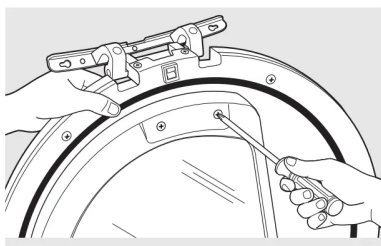

13. Hold the door on its side with one hand and fasten the remaining 2 screws as shown. Then tighten the 2 screws (#8) holding the hinge assembly.

### **Reinstall Nuts and Hinge Cover**

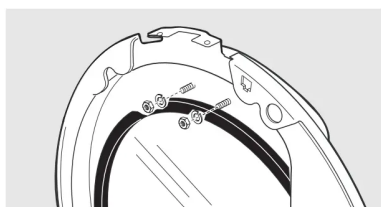

14. Place the door on its edge. Assemble the 2 machine screws (#8), washers and nuts. Tighten using a wrench and screwdriver.

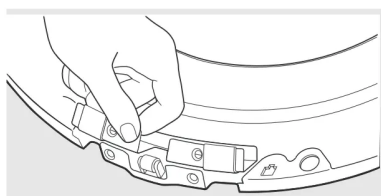

15. Place the hinge cover in position. Align the hinge cover holes with the holes in the door

16. Secure the hinge cover with the 2 tapping screws (#8).

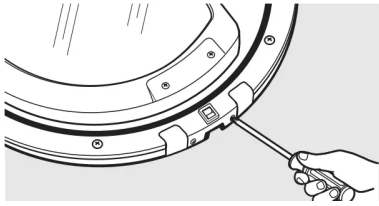

### Reassemble Door Assembly

**IMPORTANT:** Make sure there is no dirt or any other foreign material in between the window panes.

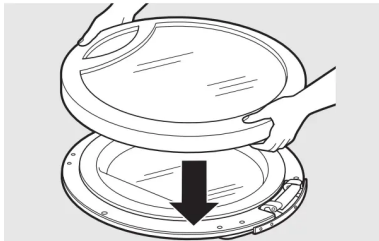

17. Place the plastic cover onto the inner door and lock in place with the 4 tabs.

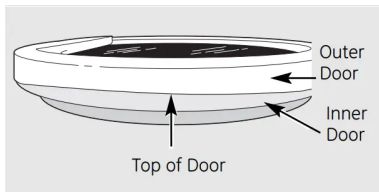

18. Place the outer door onto the inner door.

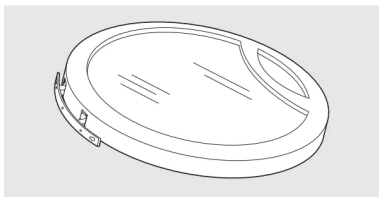

19. After reversing door, there will be a mismatch between the outer door and the inner door.

Make sure that the handle part of the outer door is opposite the hinge, as shown.

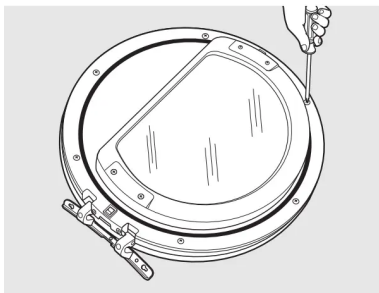

20. Turn the door over and fasten the outer door to the inner door using the 6 large tapping screws (#10).

### Move Strike Bracket

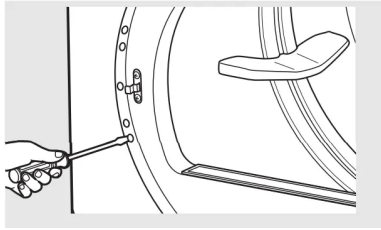

21. Using a putty knife or any other flat tool, remove the 5 plastic screw caps located on the dryer where the door will be installed and install them on the opposite side.

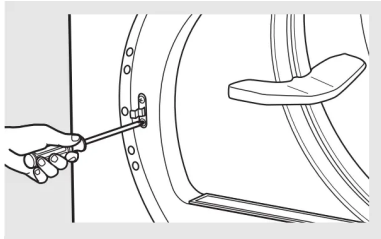

22. Switch the strike bracket and its cover on the opposite side by removing the screws; then reinstall both on the opposite side.

### Reinstall Door Assembly

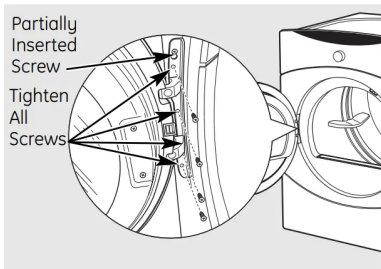

23. The door is now ready to be installed on the dryer. To ease this step, the hinge has keyholes that allow a partially fastened screw to be used as a hook.

Partially fasten a screw to the uppermost screw hole. Hook the door on the partially fastened screw.

Fasten the hinge by installing the other 4 screws and tightening the partially fastened screw above.

## Loading and using the dryer

### Fabric Care Labels

#### WASH LABELS

<i>Machine wash cycle</i>						
	Normal	Permanent Press/ wrinkle resistant	Gentle/ delicate	Hand wash	Do not wash	Do not wring
<i>Front load target water temperature</i>	<b>Category</b>	<b>Target Water Temperature</b>		<b>Automatic Temperature Control</b>		
	Tap Cold	Inlet Water Temperature		Not used		
	Cold	27°C/80°F		Used		
	Warm	40°C/105°F		Used		
	Hot	50°C/120°F		Used		
Sanitize	70°C/160°F		Used			

**DRY LABELS**

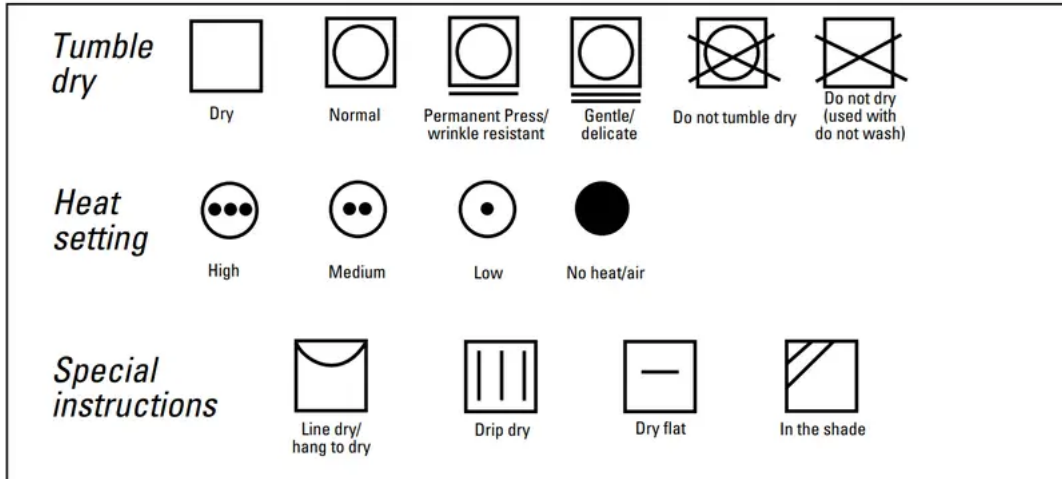

**BLEACH LABELS**

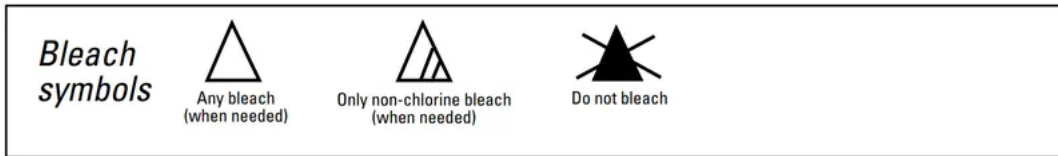

**Sorting and Loading Hints**

- As a general rule, if clothes are sorted properly for the washer, they are sorted properly for the dryer. Try also to sort items according to size. For example, do not dry a sheet with socks or other small items.
- Do not add fabric softener sheets once the load has become warm. They may cause fabric softener stains. Bounce® Fabric Conditioner Dryer Sheets have been approved for use in all GE Dryers when used in accordance with the manufacturer’s instructions.
- Do not overload. This wastes energy and causes wrinkling.
- Do not dry the following items: fiberglass items, woolens, rubber-coated items, plastics, items with plastic trim and foam-filled items.

**Care and Cleaning**

**The Exterior:**

Wipe or dust any spills or washing compounds with a damp cloth. Dryer control panel and finishes may be damaged by some laundry pretreatment soil and stain remover products. Apply these products away from the dryer. The fabric may then be washed and dried normally. Damage to your dryer caused by these products is not covered by your warranty.



**The Lint Filter:** Clean the lint filter before each use.

Pull out the lint filter. Moisten your fingers and remove the captured lint. Once clean, slide the filter back into position. Have a qualified technician vacuum the lint from the dryer once a year

**NEVER OPERATE THE DRYER WITHOUT ITS FILTER IN PLACE.**

**The Exhaust Duct:** Inspect and clean the exhaust ducting at least once a year to prevent clogging. A partially clogged exhaust can lengthen the drying time.

**Follow these steps:**

1. Turn off electrical supply by disconnecting the plug from the wall socket.
2. Disconnect the duct from the dryer.
3. Vacuum the duct with the hose attachment and reconnect the duct.

**The Exhaust Hood:** Check with a mirror that the inside flaps of the hood move freely when operating. Make sure that there is no wildlife (birds, insects, etc.) nesting inside the duct or hood.

## Venting the dryer

For the best drying performance, the dryer needs to be properly vented. The dryer will use more energy and run longer if it is not vented to the below specifications. Carefully follow the details on Exhausting in the Installation Instructions.

- Use only rigid metal or flexible metal 4" diameter ductwork inside the dryer cabinet or for exhausting to the outside.
- Do not use plastic or other combustible ductwork.
- Use the shortest length possible.
- Do not crush, kink or collapse the duct.
- Avoid resting the duct on sharp objects.
- Venting must conform to local building codes.
- Do not remove the vent protector from the back of the dryer (on some models).
- Flip the protector down to its lowest position and connect the exhaust duct to the dryer. The lowered protector will prevent the duct from getting crushed on some models).

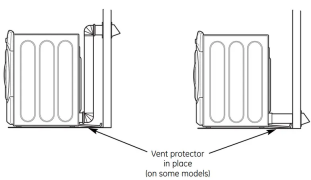
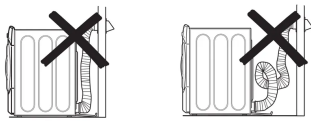
<p>Correct Venting</p>	 <p>Vent protector in place (on some models)</p>
<p>Incorrect Venting</p>	



# Troubleshooting



<b>PROBLEM</b>	<b>Possible Causes</b>	<b>What To Do</b>
Dryer shakes or makes noise	Some shaking/noise is normal. Dryer may be sitting unevenly	<ul style="list-style-type: none"> <li>• Move dryer to an even floor space, or adjust legs as necessary until even.</li> </ul>
Clothes take too long to dry	Improper or obstructed ducting	<ul style="list-style-type: none"> <li>• Check the Installation Instructions to make sure dryer venting is correct.</li> <li>• Make sure ducting is clean, free of kinks and is unobstructed.</li> <li>• Check to see if outside wall damper operates properly.</li> </ul>
	Improper sorting	<ul style="list-style-type: none"> <li>• Separate heavy items from lightweight items (generally, a well-sorted washer load is a well-drying dryer load).</li> </ul>
	Large loads of heavy fabrics (like beach towels)	<ul style="list-style-type: none"> <li>• Large, heavy fabrics contain more moisture and take longer to dry. Separate large, heavy fabrics from smaller loads to speed drying time.</li> </ul>
	Controls improperly set	<ul style="list-style-type: none"> <li>• Match control settings to the load you are drying.</li> </ul>
	Lint filter is full	<ul style="list-style-type: none"> <li>• Clean lint filter before every load.</li> </ul>
	Blown fuses or tripped circuit breaker	<ul style="list-style-type: none"> <li>• Replace fuses or reset circuit breakers. Some dryers use 2 fuses/breakers, make sure both are operating.</li> </ul>
	Overloading/combining loads	<ul style="list-style-type: none"> <li>• Do not put more than one washer load in the dryer at a time.</li> </ul>
	Underloading	<ul style="list-style-type: none"> <li>• If you are drying only one or two items, add more items to ensure proper tumbling.</li> </ul>
The DRY dryness level was chosen but load is still damp	Load consists of a mixture of heavy and light fabrics	<ul style="list-style-type: none"> <li>• When combining heavy and light fabrics in a load, choose <b>MORE DRY</b>.</li> </ul>
	Exhaust system is blocked	<ul style="list-style-type: none"> <li>• Inspect and clean exhaust system.</li> </ul>
Control pads not responding	Controls accidentally put in service mode	<ul style="list-style-type: none"> <li>• Press <b>STOP</b>.</li> </ul>

<b>PROBLEM</b>	<b>Possible Causes</b>	<b>What To Do</b>
	Controls accidentally put in lock mode	<ul style="list-style-type: none"> <li>• Hold the <b>LOCK</b> button for 3 seconds to unlock the dryer.</li> </ul>
	Controls performed an incorrect operation	<ul style="list-style-type: none"> <li>• Reset the in-house breaker.</li> </ul>
Dryer doesn't start	Control panel is "asleep"	<ul style="list-style-type: none"> <li>• This is normal. Press <b>POWER</b> to activate the control panel.</li> </ul>
	Dryer is unplugged	<ul style="list-style-type: none"> <li>• Make sure the dryer plug is pushed completely into the outlet.</li> </ul>
	Fuse is blown/circuit breaker is tripped	<ul style="list-style-type: none"> <li>• Check the building's fuse/circuit breaker box. Replace fuse or reset breaker. <b>NOTE:</b> Electric dryer uses two fuses or breakers.</li> </ul>
	Dryer was accidentally paused when starting Delay Start	<ul style="list-style-type: none"> <li>• If the light on the <b>DELAY START</b> pad is flashing, the dryer is paused. Press <b>START</b> to restart the countdown.</li> </ul>
No numbers displayed during cycle, only lights	Dryer is continuously monitoring the amount of moisture in the clothes	<ul style="list-style-type: none"> <li>• This is normal. When the dryer senses a load, it monitors the moisture in the load, and the dryer will display the time remaining.</li> </ul>
Time Remaining jumped to a lower number	The estimated time may change when a smaller load than usual is drying	<ul style="list-style-type: none"> <li>• This is normal.</li> </ul>
Cannot make a selection and the dryer beeps twice	The DRYNESS LEVEL, TEMP or OPTION that you are trying to select is incompatible with the chosen dry cycle	<ul style="list-style-type: none"> <li>• This is normal.</li> </ul>
Dryer is running but 00 is displayed in Time Remaining	The EXTEND TUMBLE option was chosen	<ul style="list-style-type: none"> <li>• This is normal. During extended tumbling, the time remaining is not displayed. The extended tumble option lasts approximately 20 minutes.</li> </ul>
Clean Lint Filter (message)	POWER button was activated	<ul style="list-style-type: none"> <li>• Press <b>START</b> to begin a dry cycle and the message will disappear.</li> </ul>



<b>PROBLEM</b>	<b>Possible Causes</b>	<b>What To Do</b>
Dryer doesn't heat	Fuse is blown/circuit breaker is tripped; the dryer may tumble but not heat	<ul style="list-style-type: none"> <li>• Check the building's fuse/circuit breaker box. If both fuses or both breakers are blown or tripped, replace both fuses or reset both breakers. The dryer may tumble if only one fuse is blown or one breaker is tripped.</li> </ul>
	Gas service is off	<ul style="list-style-type: none"> <li>• Make sure gas shutoff at dryer and main service are fully open.</li> </ul>
	LP gas supply tank is empty or there has been a utility interruption of natural gas (gas models)	<ul style="list-style-type: none"> <li>• Refill or replace tank. Dryer should heat when service is restored.</li> </ul>
Inconsistent drying times	Type of heat	<ul style="list-style-type: none"> <li>• Drying time will vary according to the type of heat used. If you recently changed from an electric (natural or LP) dryer, or vice versa, the drying times could be different.</li> </ul>
	Type of load and drying conditions	<ul style="list-style-type: none"> <li>• The load size, types of fabric, wetness of clothes, the length and condition of the exhaust system can affect drying times.</li> </ul>
Glow at the rear of the drum	Heaters behind the drum	<ul style="list-style-type: none"> <li>• This is normal. Under certain drying conditions and room ambient lighting, the glow of the heaters may be visible at the rear of the drum.</li> </ul>
Clothes are still wet and dryer shut off after a short time	The door was opened mid-cycle. The load was then removed from the dryer and a new load put in without selecting a new cycle	<ul style="list-style-type: none"> <li>• A dry cycle must be reselected each time a new load is put in.</li> </ul>
	Small load	<ul style="list-style-type: none"> <li>• When drying 3 items or less, choose <b>SPEED DRY</b> or <b>TIMED DRY</b>.</li> </ul>
	Load was already dry except for collars and waistbands	<ul style="list-style-type: none"> <li>• Choose <b>SPEED DRY</b> or <b>TIMED DRY</b> to dry collars and waistbands. In the future, when drying a load with collars and waistbands, choose <b>MORE CARE</b>.</li> </ul>



<b>PROBLEM</b>	<b>Possible Causes</b>	<b>What To Do</b>
	Dryer is not level	<ul style="list-style-type: none"> <li>• Move dryer to an even floor space or adjust legs as necessary until even.</li> </ul>
Clothes are wrinkled	Overdrying	<ul style="list-style-type: none"> <li>• Select a shorter drying time.</li> <li>• Remove items while they still hold a slight moisture. Select a <b>LESS DRY</b> or <b>DAMP</b> setting.</li> </ul>
	Letting items sit in dryer after cycle ends	<ul style="list-style-type: none"> <li>• Remove items when cycle ends and fold or hang immediately, or use the <b>EXTEND TUMBLE</b> feature.</li> </ul>
	Overloading	<ul style="list-style-type: none"> <li>• Separate large loads into smaller ones.</li> </ul>
Clothes shrink	Some fabrics will naturally shrink when washed. Others can be safely washed, but will shrink in the dryer	<ul style="list-style-type: none"> <li>• To avoid shrinkage, follow garment care labels exactly.</li> <li>• Some items may be pressed back into shape after drying.</li> <li>• If you are concerned about shrinkage in a specific item, do not machine wash or tumble dry it.</li> </ul>
Greasy spots on clothes	Improper use of fabric softener	<ul style="list-style-type: none"> <li>• Follow directions on fabric softener packaging.</li> </ul>
	Drying dirty items with clean ones	<ul style="list-style-type: none"> <li>• Use your dryer to dry only clean items. Dirty items can stain clean items and the dryer.</li> </ul>
	Clothes were not completely clean	<ul style="list-style-type: none"> <li>• Sometimes stains which cannot be seen while clothes are wet <i>appear</i> after drying. Use proper washing procedures before drying.</li> </ul>
Lint on clothes	Lint filter is full	<ul style="list-style-type: none"> <li>• Clean lint screen before each load.</li> </ul>
	Improper sorting	<ul style="list-style-type: none"> <li>• Sort lint producers (like chenille) from lint attractors (like corduroy).</li> </ul>
	Static electricity can attract lint	<ul style="list-style-type: none"> <li>• See suggestions in this section under <b>STATIC</b>.</li> </ul>

<b>PROBLEM</b>	<b>Possible Causes</b>	<b>What To Do</b>
	Overloading	<ul style="list-style-type: none"> <li>• Separate large loads into smaller ones.</li> </ul>
	Paper, tissue, etc., left in pockets	<ul style="list-style-type: none"> <li>• Empty all pockets before laundering clothes.</li> </ul>
Static occurs	No fabric softener was used	<ul style="list-style-type: none"> <li>• Try a fabric softener.</li> <li>• Bounce® Fabric Conditioner Dryer Sheets are approved for use in all GE Dryers when used in accordance with the manufacturer's instructions.</li> </ul>
	Overdrying	<ul style="list-style-type: none"> <li>• Try a fabric softener.</li> <li>• Adjust setting to <b>LESS DRY</b> or <b>DAMP</b>.</li> </ul>
	Synthetics, permanent press and blends can cause static	<ul style="list-style-type: none"> <li>• Try a fabric softener.</li> </ul>
Collars and waistbands still wet at end of cycle	The dryness monitor senses that the body of the clothes is dry	<ul style="list-style-type: none"> <li>• Choose <b>SPEED DRY</b> or <b>TIMED DRY</b> to dry collars and waistbands. In the future, when drying a load with collars and waistbands, choose <b>MORE DRY</b>.</li> </ul>

### Warning

This content is compiled from multiple sources and is provided for reference purposes only. It may not be complete or fully applicable to all situations. If you are unable to resolve your issue, please contact the product manufacturer or an authorized service provider for official support.