

## User Manual

# INSTALLATION

## Parts and Specifications

**NOTE:** Appearance and specifications may change without notice to improve the quality of the appliance.

### Front View

\*This feature is only available on some models.

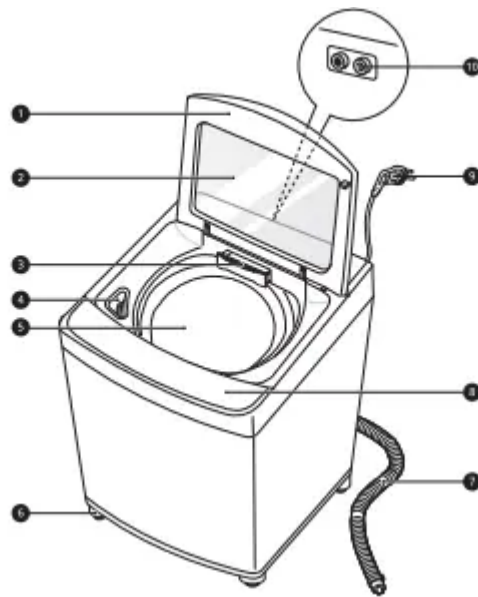

- ① Door
- ② Tempered Glass
- ③ Dispenser Drawer
- ④ Bleach Dispenser
- ⑤ Drum
- ⑥ Levelling Feet
- ⑦ Drain Hose\*
- ⑧ Control Panel
- ⑨ Power Cord
- ⑩ Hot and Cold Water Inlets

### Accessories

\*This feature is only available on some models.



- ❶ Cold and Hot Water Inlet Hoses
- ❷ Drain Hose\*
- ❸ Tie Strap\*

## Specifications

Model	WTG1434VHF/ WTG1434BHF/ WTG1434WHF	WTG1234WF	WTG1034WF/ WTG1034BF
Power Supply	220 - 240 V~, 50 Hz		
Dimension (Width X Depth X Height)	690 mm X 730 mm X 1023 mm		
Product Weight	Approx. 60 kg		
Permissible Inlet Water Pressure	50 - 600 kPa		

## Dimension(mm)

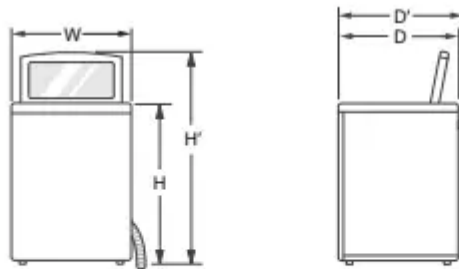

W	690	D	730	H	1023
D'	760	H'	1410		

## Installation Place Requirements

Before installing the appliance, check the following information in order to install the appliance in a correct place.

### Installation Location

- Install the appliance on a flat floor of hard material that is strong enough to support a fully loaded appliance. (Allowable slope under the appliance: 1o)
- Never try to level any uneven floor by putting pieces of wood, cardboard or similar materials under the appliance.

- If it is impossible to avoid positioning the appliance next to a gas cooker or coal burning stove, an insulation (85 X 60 cm) covered with aluminium foil on the side facing the cooker or stove must be inserted between the two appliances.
- Ensure that when the appliance is installed, it is easily accessible for a service technician in the event of a breakdown.
- Additional clearance for the wall should have 10 cm for the rear and 2 cm for right and left side.

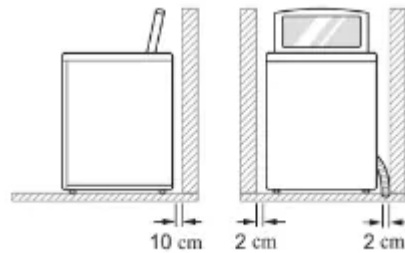

**WARNING:** This appliance must only be used for domestic household purposes and should not be used in mobile applications.

**NOTE:** Do not install this appliance on a raised surface or platform, plinth or stand. It may cause injury or serious malfunctioning.

### Ventilation

Make sure that air circulation around the appliance is not impeded by carpets, rugs, etc.

### Ambient Temperature

- Do not install the appliance in rooms where freezing temperatures may occur. Frozen hoses may burst under pressure. The reliability of the electronic control unit may be impaired at temperatures below freezing point.
- If the appliance is delivered in winter and temperatures are below freezing, place the appliance at room temperature for a few hours before putting it into operation.

### Electrical Connection

- Do not use an extension cord or double adapter.
- Always unplug the appliance and turn off the water supply after use.
- Connect the appliance to an earthed socket in accordance with current wiring regulations.
- The appliance must be positioned so that the plug is easily accessible.
- Power outlet must be within 1.5 meters of either side of the appliance.

## WARNING

- Repairs to the appliance must only be carried out by qualified personnel. Repairs carried out by inexperienced persons may cause injury or serious malfunctioning. Contact your local authorised LG repairer.
- The power plug must be plugged into an appropriate outlet socket that is installed and grounded/earthed in accordance with all local codes and ordinances.

## Connecting the Water Inlet Hoses

Before connecting the water inlet hose to the water tap, check the hose fitting type and then choose the correct instruction.

### Note for Connection

- Water supply pressure must be between kPa and 600 kPa (0. - 6.0 kgf / cm<sup>2</sup>). If the water supply pressure is more than 600 kPa, a decompression device should be installed.
- Do not overtighten the water inlet hoses to the valves.
- Periodically check the condition of the hose and replace the hose if necessary.

### Checking the Rubber Seal

Two rubber seals 1 are supplied with the water inlet hoses. They are used to prevent water leaks. Connection to taps is sufficiently tight.

- Do not use mechanical devices such as multi grips to tighten the inlet hoses. Ensure that the curved end of the water inlet hose is connected to the appliance.

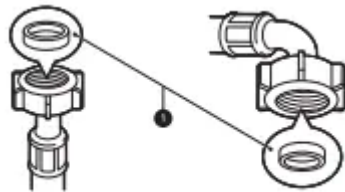

### Connecting the Hose to the Water Tap

#### Connecting Screw-Type Hose to Tap with Thread

Screw the hose connector onto the water supply tap. Hand tighten only with the aid of a soft cloth.



**NOTE:** After connecting the water inlet hose to the water tap, turn on the water tap to flush out foreign substances (dirt, sand, sawdust, and etc.) in the water lines. Let the water drain into a bucket, and check the water temperature.

### Connecting the Hose to the Appliance

Screw the water inlet hose to the water inlet valve on the back of the appliance.

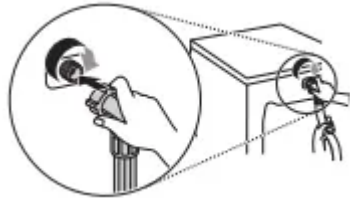

- Do not connect the hose to the hot water supply for models with one water inlet. Connect to the cold water supply only.

**NOTE:** After completing connection, if water leaks from the hose, repeat the same steps. Use the most conventional type of tap for the water supply. In case that the tap is square or too big, remove the guide plate before inserting the tap into the adaptor.

### Installing the Drain Hose

Before connecting the drain hose, check your drain hose model and choose the correct instruction.

#### Installing the Drain Hose with the Elbow Bracket

The drain hose must not be placed higher than 120 cm above the floor. Water in the appliance may not drain or may drain slowly.

- Securing the drain hose correctly will protect the floor from damage due to water leakage.

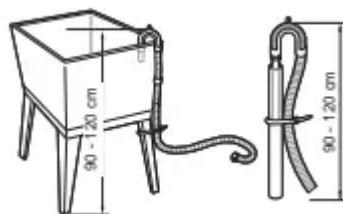

- If the drain hose is too long, do not force the drain hose further into the drain outlet. This will cause abnormal noise.
- When installing the drain hose to a sink, secure it tightly with the some string, cable tie, or chain.

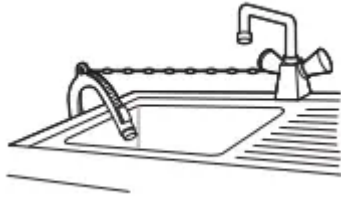

**NOTE:** The discharge height should be approximately 90 - 120 cm from the floor.

## Levelling the Appliance

### Checking the Level

Levelling the appliance prevents unnecessary noise and vibration. Check whether the appliance is perfectly level after installation.

- If the appliance rocks when pushing the top plate of the appliance diagonally, adjust the feet again.

### Adjusting and Levelling the Feet

When the appliance is not perfectly level, turn the adjustable feet until the appliance no longer wobbles.

- Turn the adjustable feet clockwise to raise or turn the adjustable feet counterclockwise to lower from front-to-back, side-to-side and corner-to-corner.

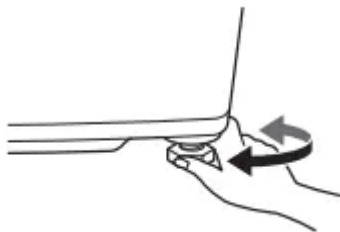

### NOTE

- Do not insert pieces of wood etc. under the feet.
- Timber or suspended type flooring will contribute to excessive vibration and unbalance.
- Reinforcing or bracing the timber floor may need to stop or reduce excessive noise and vibration.
- Do not install the appliance on any elevated surface or platform, as it may become unstable and cause serious injury and damage.
- If the appliance is installed on a uneven, weak or tilted floor causing excessive vibration, spin failure or UE error can occur. It must be placed on a firm and level floor to prevent spin failure.

# OPERATION

## Operation Overview

### Using the Appliance

Before the first wash, select the Cotton Wash programme and add a half amount of detergent. Start the appliance without laundry.

- This will remove residue and water from the drum that may have been left during manufacturing.

#### 1. Sort laundry and load items.

- Sort laundry by fabric type, soil level, colour and item size as needed. Open the door and load items into the appliance.

#### 2. Add detergent, fabric softener and/or bleach.

- Add the proper amount of detergent to the detergent dispenser drawer. If desired, add bleach or fabric softener to the appropriate areas of the dispenser.

#### 3. Turn on the appliance.

- Press the POWER button to turn on the appliance.

#### 4. Choose the desired wash cycle.

- Press the Program button repeatedly until the desired programme is selected.
- Select the option button to adjust wash temperature, spin speed, etc. Refer to a fabric care label of your clothes for any warning or special instructions.

#### 5. Begin cycle.

- Press the START/PAUSE button to begin the cycle.
- The appliance will agitate briefly without water to measure the weight of the laundry.
- If the START/PAUSE button is not pressed within a certain time, the appliance will shut off and all settings will be lost.

#### 6. End of cycle.

- When the cycle is finished, a melody will sound. Immediately remove your clothing from the appliance to reduce wrinkling.

**NOTE:** The Auto Restart function allows the cycle to restart by itself in case of power failure. It resumes from the stage where it stopped.

## Preparing Laundry

Sort laundry for best washing results, and then prepare laundry according to the symbols on the care labels.

## Sorting the Clothes

- For best washing results, sort your clothes according to a care label stating fabric type and washing temperature. Adjust the spin speed to wash them.
- Soil level (Heavy, Normal, Light): Separate clothes according to soil level. If possible, do not wash heavily soiled items with lightly soiled ones.
- Colour (White, Lights, Dark): Wash separately dark or dyed clothes from whites or light colours. Mixing dyed clothes with light clothes can result in dye transfer or discolouration of lighter clothes.
- Lint (Lint producers, Collectors): Wash separately lint producing fabrics from lint collecting fabrics. Lint producers can result in pilling and linting on the lint collectors.

## Checking the Fabric Care Label

This will tell you about the fabric content of your clothes and how it should be washed.

### Symbols on the Care Labels

Symbol	Wash / Fabric type
	<ul style="list-style-type: none"><li>• Normal Wash</li><li>• Cotton, Mixed Fabrics</li></ul>
	<ul style="list-style-type: none"><li>• Easy Care</li><li>• Synthetic, Mixed Fabrics</li></ul>
	<ul style="list-style-type: none"><li>• Special Delicate Wash</li><li>• Delicates</li></ul>
	<ul style="list-style-type: none"><li>• Hand Wash Only</li><li>• Wool, Silk</li></ul>
	<ul style="list-style-type: none"><li>• Do not wash</li></ul>

**NOTE:** The dashes under the symbol give you information about the type of fabric and the maximum allowance of mechanical stress.

### Checking the Laundry before Loading

- Combine large and small items in a load. Load large items first. Large items should not be more than half of total load.
- Do not wash single small items. Add 1 - 2 similar items to the load to prevent an out-of-balance load.
- Make sure to empty all pockets. Items such as hair clips, lighters, pens, coins and keys can cause irreparable damage to both your appliance and clothes.



- Wash delicates (stockings, underwired bras) in a wash net.
- Close zippers, hooks and strings to make sure that these items do not snag other clothes.
- Pre-treat dirt and stains by saturating the dirt and stains with dissolved detergent and brushing them in order to remove dirt.

### **CAUTION**

- Do not wash or spin any item labelled or known to be water-proof or water-resistant, even if the product care label on the item permits machine washing. Failure to follow these instructions could result in severe damage to your washing load, your appliance and/or property damage as a result of abnormal load friction or vibration of the appliance.

- Examples of water-proof or water-resistant items include certain mattress pads, mattress covers, rain gear, camping gear, skiing apparel, outdoor gear and similar items.

## **Adding Detergents, Softeners and Bleaches**

### **Detergent Dosage**

- Detergent should be selected according to fabric type, colour, soil level and washing temperature and should be used according to the detergent manufacturer's instructions.
- Too much detergent results in excessive suds which cause poor washing.
- When you use liquid detergent, follow the guidelines provided by the detergent manufacturer.
- You can pour liquid detergent directly into the main detergent drawer if you are starting the wash cycle immediately. It is also recommended that it be added into the drum when loading the clothes.
- Do not use liquid detergent if you are using Time Delay function, or if you have selected Pre Wash+Cotton option, as the liquid may harden.
- Reduce the amount of detergent if too many suds are formed.
- Detergent usage may need to be adjusted for water temperature, water hardness, size and soil level of the laundry. For best results, avoid oversudsing.

- Refer to the label of the clothes, before choosing the detergent and water temperature.
- Use only suitable detergents for the respective type of clothing:
  - General powdered detergents for all types of fabric
  - Powdered detergents for delicate fabric
  - Liquid detergents for all types of fabric or designated detergents only for wool
- For better washing performance and whitening, use detergent that contains general powdered bleach.
- Detergent is dispensed from the dispenser at the beginning of the cycle.
- Dilute liquid detergent with water, pour into the drum and start the cycle.

**CAUTION:** Using liquid detergent without diluting, or leaving laundry for a long time after pouring diluted liquid detergent into the drum might cause the clothes to be damaged, bleached, discoloured.

#### **NOTE**

- Do not let the detergent harden. Doing so may lead to blockages, poor rinse performance or odour.
- Full load: According to manufacturer's recommendation.
- Part load: 3/4 of the normal amount
- Minimum load: 1/2 of full load

#### **Adding Detergents**

- Add the measured amount of detergent into the detergent compartment 1.

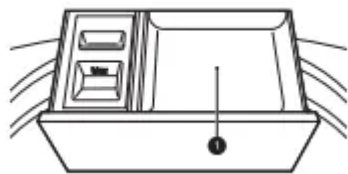

- Use more detergent if you have hard water, large items, greasy or oily soils or lower water temperature.
- Soap flakes or granulated soap powders should not be used in the appliance. When washing woollens, remember to use detergent suitable for washing woollens.

**NOTE:** Use the appropriate amount of detergent. Too much detergent, bleach or softener may cause an overflow or a malfunction.

#### **Adding Fabric Softeners**

- Add a fabric softener to the maximum fill line.

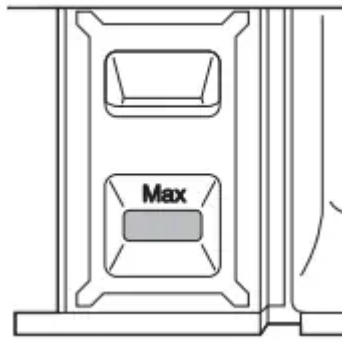

- If the softener is concentrated, then it should be diluted.
- Close the dispenser drawer gently.
- Do not leave the fabric softener in the detergent drawer for more than 2 days. Fabric softener may harden.
- Softener will automatically be added during the last rinse cycle.
- Do not open the drawer when water is being supplied.
- Solvents (benzene, etc.) must never be used.

#### **NOTE**

- Pouring excessive fabric softener over the maximum fill line can cause it to dispense too early, which may stain clothes.
- Do not pour fabric softener directly onto the laundry, doing so will cause staining on the clothes that will be difficult to remove.

#### **Adding Liquid Bleaches**

- Before starting the appliance, pour the measured amount of bleach directly into the bleach dispenser 1. Avoid splashing or overfilling.

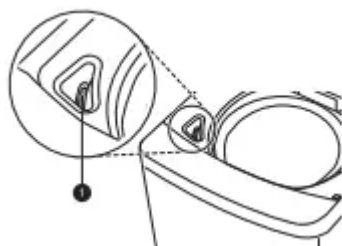

- Mix powdered bleach with water to a liquid consistency and pour it into the bleach dispenser.
- Check clothing care label for special instructions and separate the laundry to be bleached.
- Dilute liquid chlorine bleach with water.
- Measure the recommended amount of liquid bleach carefully according to instructions on the bottle.

## CAUTION

- Never pour undiluted liquid bleach directly onto laundry or into the wash basket. This may cause change of colour or damage to the laundry.
- Do not pour powdered bleach into the bleach dispenser. Powdered bleach may harden, so it will block the bleach dispenser.

## Control Panel

### Control Panel Features

#### For Vapour Mode Models

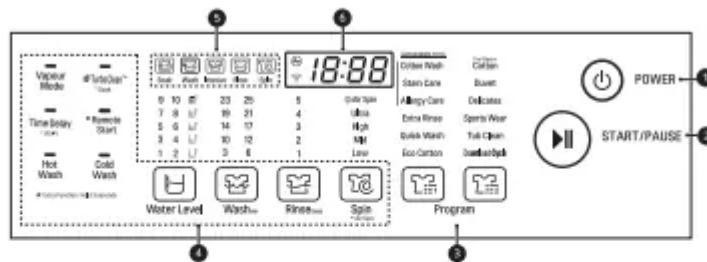

#### For Non-Vapour Mode Models

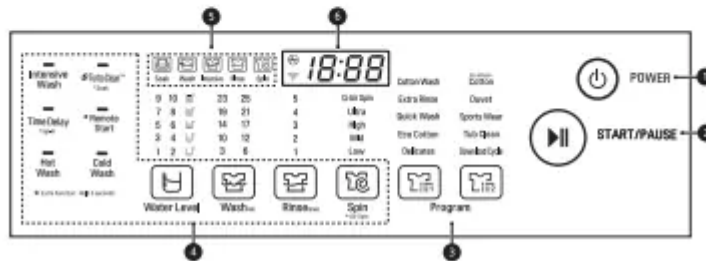

### 1. POWER Button

- Press the POWER button to turn on or off the appliance.
- The appliance automatically turns off once a certain time has passed after the wash has completed.

### 2. START/PAUSE Button

- Press the START/PAUSE button to start or pause a wash cycle.
- Press the START/PAUSE button to stop a wash cycle temporarily.

## NOTE

- If the wash is not recommenced within 60 minutes when in pause, then the appliance will automatically turn off.
- For customer safety, the door will be locked automatically during operation. If there is additional laundry to put in, press START/PAUSE to unlock.

### 3. Program Button

- Programmes are available according to the laundry type.

- The lamp will light up to indicate the selected programme.



#### 4. Extra Options and Functions

- You can use the extra options and functions to customize the programmes.

#### 5. Cycle Status Indicator

- The cycle status indicator is turned on before the start.
- The cycle status indicator blinks during that process, and then the indicator turns off when that process has completed.

#### 6. Display

- The display shows the settings, remaining estimated time, options, and status messages. When the appliance is turned on, the default settings in the display will light up.
- 18:88: When a programme is selected, the default time for that programme is displayed. The time can change as options are selected.
  - If the display shows --:-- , then the time will be displayed after the load sensing has detected the laundry size.
  - The time shown is only an estimate. Several external factors (laundry size, room temperature, incoming water temperature, etc.) can affect the actual time.
-  : The Door Lock icon turns on when the cycle starts and the door is locked.
-  : The Wi-Fi icon turns on when the appliance is connected to Wi-Fi network at home.

### Programme

Wash programmes are designed for the best wash performance for different types of clothes.

- Press the Program button to select the desired programme.
- When you select a wash programme, the light for the corresponding wash programme will turn on.

#### Cotton Wash

Use this programme to wash cotton laundry.

- This programme automatically selects the most appropriate conditions and completes the sequence in one operation.
- The built-in sensor detects the weight of the laundry and the ideal wash power and wash, rinse and spin times are set accordingly.
- If water or wet laundry is already in the drum before the start, the water level will be increased.

- For lightweight and bulky items, the water level may be too low. Increase the water level manually.

### **Stain Care**

This feature is only available on some models.

Use this programme to remove stains efficiently. Water will be heated up to about 40 °C under this programme for the best washing result.

- This programme uses more warm water than other programmes as it has higher set temperature for heating.
- Stains that can be easily removed with this programme are coffee, soda, juice, soy sauce etc.
- If only cold water is connected, it takes longer laundry time as heating time lengthens.

### **NOTE**

- Due to higher water temperatures used, this programme is not recommended for wool, silk, leather, or any other delicates or temperature sensitive items.
- While heating, water drops might be created at the door glass due to humidity differences. This is normal. Wipe the door glass after the wash cycle is completed.
- Be careful as the exterior of the appliance is hot by heating.
- This programme's recommended amount of laundry is under 5.85 kg.

### **Allergy Care**

This feature is only available on some models.

This programme is specifically designed for reducing certain allergens at a powerful, high temperature.

- Stains that can be easily removed with this programme are milk, blood, sebum, egg, etc.
- If only cold water is connected, it takes longer laundry time as heating time lengthens.

### **NOTE**

- Due to higher water temperatures used, this programme is not recommended for wool, silk, leather, or any other delicates or temperature sensitive items.
- While heating, water drops might be created at the door glass due to humidity differences. This is normal. Wipe the door glass after the wash cycle is completed.
- Be careful as the exterior of the appliance is hot by heating.
- This programme's recommended amount of laundry is under 4.5 kg.

### **Extra Rinse**

Use this programme to increase rinsing performance.

- This programme is recommended for underwear and baby clothes.
- If someone has sensitive skin or skin trouble, use this programme.

### Quick Wash

Use this programme to wash lightly soiled clothes for a short time.

**NOTE:** This programme's recommended amount of laundry is under 4.5 kg.

### Eco Cotton

Use this programme to consume less water and electricity to wash normally soiled cotton load.

### Information for Energy Test

Select the water temperature to suit wash cycles. Always follow clothes manufacturer's care label or instructions when washing.

- For normally soiled items, select the programme and options as below and test it in accordance with AS/NZS 2040. 1.
  - Programme: Eco Cotton
  - Option: press Water Level for 3 seconds, Hot Wash and Cold Wash
- The test results depend on water pressure, water hardness, water supply temperature, room temperature, type and amount of laundry, type and amount of detergent, fluctuations in the main electricity supply and chosen additional options.
- During water supply, press the START/PAUSE button to pause, open the door and add the detergent powder (drum type) that has been diluted with warm water directly into the drum.
- Press the START/PAUSE button to resume the cycle.
- Since this cycle is programmed to use a lesser amount of water, usage of fabric softener is not recommended.
- At the end of hot wash fill, the washing operation starts.

### Pre Wash+Cotton

Use this programme to pretreat immediate stain without handwash.

- It is necessary for clothes which could smell bad if they are not washed promptly.

### Duvet

Use this programme to wash a blanket or bedclothes that have the hand wash sign on the care label.

- Cashmere bedclothes, acrylic blanket, mixed spinning blanket, woollen blanket, infilling polyester 101), and bed sheets might be damaged if they are allowed to float. It is recommended to purchase a separate laundry net to wash.
- Separate bed clothes from general clothes. It might cause laundry to be unbalanced, which results in abnormal washing.
- Spin dry might take longer to redistribute the laundry evenly if bedclothes are lumped to a side.
- Never wash an electric blanket, carpets, rugs, pet accessories, soft toys or shoes. It can cause damage to the appliance and other items in the wash.
- Put bedclothes into a laundry net and then soak and sink them in water so that they are less likely to float. If the items float during the wash or spin, it may damage the appliance and the clothes.
- Regardless of size, we recommend washing bedclothes individually. If two bedclothes with different materials are washed at the same time, it might cause a spin malfunction due to imbalance.

**CAUTION:** When putting a blanket into the drum, do not load it over the maximum line 1. The blanket must also be submerged in the water. Failure to do so or overloading the blanket in the appliance will result in damage to the wash load and the appliance.

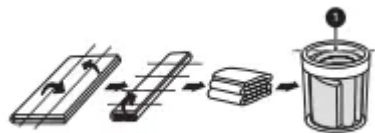

### Delicates

Use this programme to wash delicate fabrics such as lingerie and woollens. Before washing, check the care label for the washing instructions.

- This programme uses a slow spin to prevent the clothes from being damaged, so the laundry has more moisture than normal.

### NOTE

- Hang or lay your delicates flat when you dry them.
- Only cold water will be used for this programme as hot water may damage laundry.

### Sports Wear

This programme is suitable for sports wear such as jogging clothes and running wear.

### Tub Clean

This is a special function to clean inside the drum of your appliance.

- To use this function, refer to the MAINTENANCE for details.

### Download Cycle

Download a new or special washing programme to this appliance using the smartphone. It will be placed in this programme position.

- You can check the default programme in the LG ThinQ application.

### Extra Options and Functions

You can use the extra options and functions on some programmes to customize the cycle.

- The extra options and functions can be changed when the START/PAUSE button is pressed during operation depending on the selected programmes, options and functions.

### Water Level

This appliance detects the amount of laundry automatically, then sets the water level. However, manually increasing the water level may be required and recommended to avoid linting and unbalanced errors when the load is bulky but lightweight.

- Press Water Level option to adjust water level.
- When you select a wash programme, the water level will be shown on the control panel.
- When water level is automatically detected, it may differ depending on the amount of laundry even though the same water level is indicated on the control panel.

### Wash

Adjusting the wash time setting modifies the cycle times and/or wash actions.

- Press Wash button until the desired wash time is selected.

### Rinse

Use this option to change the number of rinses.



- Press Rinse button to change the number of rinses.
- When the Rinse option is selected,  icon is lit.
- If selecting the maximum number of rinses, then this option is deactivated.

**NOTE:** This option is only available on some programmes.

### Intensive Rinse

Use this option to remove detergents more effectively.

- When the Rinse button is pressed, Intensive Rinse option is selected.

- When the Intensive Rinse option is selected,  and  icons are lit.
- If selecting the maximum number of rinses, then this option is deactivated.

**NOTE:** This option is only available on some programmes.

### Spin

Use this option to change the spin strength. When you press the START/PAUSE button after selecting this option, the remaining time is indicated on the display.

#### To Use the Air Spin Function

When you select Air Spin, you can reduce the drying time by minimizing the moisture that remains within the clothes.

- Press the Spin button for 3 seconds to select and press the POWER button to deselect.

#### NOTE

- Always keep the laundry amount to 2 kg or less and make sure to redistribute the laundry evenly.
- Select 60 minutes for cotton laundry and 120 minutes for synthetic fibre laundry for effective moisture reduction.

### Vapour Mode

This feature is only available on some models.

Use this option to enhance washing performance with vapour.

- This option is automatically selected under the Allergy Care programme.

### Intensive Wash

This feature is only available on some models. Use this option to allow a higher agitation intensity.

- It is set to medium intensity by default and it is not indicated on the display.
- It can be set on all programmes except Delicates and Tub Clean.

### Turbo Clean™

Use this option to save time and energy by using the jet spray technology.

### Soak

This option can be selected to wash heavily soiled clothes by soaking them in water for some time to loosen dirt and grime.

- When this option is activated, the  icon is lit.
- To activate this option, press and hold the Turbo Clean™ button for 3 seconds.

- To change the soak time on the display or deactivate this option, press the Turbo Clean™ while this option is activated.

**NOTE:** While the Turbo Clean™ option is activated, this option cannot be set even if the Turbo Clean™ button is pressed for 3 seconds.

### Time Delay

Use this function to delay ending time. The appliance will start automatically and finish after a specified time interval.

1. Press the POWER button.
2. Select a washing programme.
3. Press the Time Delay button to set the required delay ending time.
4. Press the **START/PAUSE** button.

### NOTE

- This function is the time to the end of the programme, not the start. The actual running time may vary due to water temperature, wash laundry and other factors.
- Reservation can be made up to 18 hours;
  - 1 hour interval up to 3 - 12 hours
  - 2 hours interval up to 12 - 18 hours
- This function cannot be set for less than 3 hours.
- To cancel this function, press Time Delay button repeatedly until the reservation is cancelled or press the POWER button to turn off and on power.

### Wi-Fi

When WLAN is connected to the appliance, the Wi-Fi  icon on the control panel is lit.

- Press and hold Time Delay button for 3 seconds to register the appliance in the LG ThinQ application.

### Remote Start

Use a smartphone to control your appliance remotely.

- In order to use this function, refer to SMART FUNCTIONS.

### Hot Wash / Cold Wash

- Press the Hot Wash and/or Cold Wash buttons to select hot water, cold water, or hot and cold water (warm water).
- If Hot Wash is selected, washing will be done with hot water and rinse will be done with cold water.
- Under normal and standard user environments, warm water will enter the drum when both hot water and cold water are selected.

## NOTE

- **Delicates** programme is cold water only. If hot water is used, the laundry can be damaged.
- Both Hot Wash and Cold Wash are automatically selected under **Extra Rinse** and **Tub Clean** programmes.

## Child Lock

Use this function to disable the controls. This function can prevent children from changing programmes or operating this appliance.

## NOTE

- Once this function is set, all buttons are locked except the POWER button.
- When the controls are locked, CL and the remaining time are alternatively shown on the display during the wash while the child lock is engaged.
- Turning off the power will not reset this function. You must deactivate this function before you can access any other options and functions.

## Locking the Control Panel









1. Turn on the power.
2. Press and hold the Water Level and Spin buttons simultaneously for 3 seconds to activate this function.

## Unlocking the Control Panel

1. Turn on the power.
  2. Press and hold the Water Level and Spin buttons simultaneously for 3 seconds to deactivate this function.
- When this function is deactivated, a beeper will sound and the remaining time for the current cycle will reappear on the display.

## Manual Washing

When you need a rinse and spin, spin only, rinse only or wash only cycle, these can be set manually.

	Rinse and Spin	Spin only	Rinse only	Wash only
1	 Press the <b>POWER</b> button.			
2	 Press the <b>Rinse</b> button.	 Press the <b>Spin</b> button.	 Press the <b>Rinse</b> button.	 Press the <b>Wash</b> button.
3	Rinse and spin are automatically selected.	Press the <b>Spin</b> button to adjust spin strength.	Press the <b>Spin</b> button until the spin function is cancelled.	Rinse and spin are automatically selected.
4	 Press the <b>Rinse</b> or <b>Spin</b> buttons to adjust the number of rinses or spin strength.		 Press the <b>Rinse</b> button to adjust the number of rinses.	 Press the <b>Rinse</b> and <b>Spin</b> buttons until the rinse and spin functions are cancelled.
5	 Press the <b>START/PAUSE</b> button to start the cycle(s).			

## NOTE

- When you set a washing cycle manually such as rinse only, wash only or wash and rinse, the water will not be drained out after the wash is completed. If you wish to drain the water, select a spin only cycle after the wash has completed.
- If a rinse only cycle is selected, the water supply begins after detecting the load and the cycle will start. However the water will still fill to the selected water level even if there is water already in the tub.
- If you do not select or change the Water Level, the water level will be set automatically.

## SMART FUNCTIONS

### LG ThinQ Application

This feature is only available on the model with  or  logo.

The **LG ThinQ** application allows you to communicate with the appliance using a smartphone.

### LG ThinQ Application Features

Communicate with the appliance from a smartphone using the convenient smart features.

#### Washer Cycle (Remote Start, Download Cycle)

Set or download any preferred cycle and operate by remote control.

#### Tub Clean Coach

This function shows how many cycles remain before running the Tub Clean function.

#### Energy Monitoring

This function checks the energy consumption of the recently used cycles and monthly average.

### Smart Diagnosis

This function provides useful information for diagnosing and solving issues with the appliance based on the pattern of use.

### Settings

Allows you to set various options on the appliance and in the application.

### Push Alert

When the cycle is complete or the appliance has problems, you have the option of receiving push notifications on a smartphone. The notifications are triggered even if the LG ThinQ application is off.

### NOTE

- If you change your wireless router, Internet service provider, or password, delete the registered appliance from the LG ThinQ application and register it again.
- The application is subject to change for appliance improvement purposes without notice to users.
- Functions may vary by model.

### Before Using LG ThinQ Application

1. Check the distance between the appliance and the wireless router (Wi-Fi network).

- If the distance between the appliance and the wireless router is too far, the signal strength becomes weak. It may take a long time to register or installation may fail.

2. Turn off the Mobile data or Cellular Data on your smartphone.

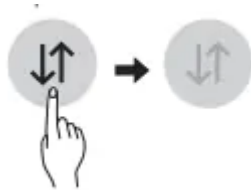

3. Connect your smartphone to the wireless router.



### NOTE

- To verify the Wi-Fi connection, check that the Wi-Fi icon on the control panel is lit.

- The appliance supports 2.4 GHz Wi-Fi networks only. To check your network frequency, contact your Internet service provider or refer to your wireless router manual.
- **LG ThinQ** is not responsible for any network connection problems or any faults, malfunctions, or errors caused by network connection.

## **NOTE**

- If the appliance is having trouble connecting to the Wi-Fi network, it may be too far from the router. Purchase a Wi-Fi repeater (range extender) to improve the Wi-Fi signal strength.
- The Wi-Fi connection may not connect or may be interrupted because of the home network environment.
- The network connection may not work properly depending on the Internet service provider.
- The surrounding wireless environment can make the wireless network service run slowly.
- The appliance cannot be registered due to problems with the wireless signal transmission.
- Unplug the appliance and wait about a minute before trying again.
- If the firewall on your wireless router is enabled, disable the firewall or add an exception to it.
- The wireless network name (SSID) should be a combination of English letters and numbers. (Do not use special characters.)
- Smartphone user interface (UI) may vary depending on the mobile operating system (OS) and the manufacturer.
- If the security protocol of the router is set to WEP, you may fail to set up the network. Please change it to other security protocols (WPA2 is recommended) and register the product again.

## **Installing the LG ThinQ Application**

Search for the LG ThinQ application from the Google Play Store or Apple App Store on a smartphone. Follow instructions to download and install the application.

## **Using the Appliance Remotely**

### **Remote Start**

Use a smartphone to control your appliance remotely. You can also monitor your cycle operation so you know how much time is left in the cycle.

### **Using this function**

1. Put the laundry into the drum and add detergent into the detergent dispenser drawer.
  - If desired, add bleach or fabric softener to the appropriate areas of the dispenser.
2. Press the POWER button.
3. Press and hold Remote Start button for 3 seconds to enable the remote control function.
4. Start a cycle from the LG ThinQ application on your smartphone.

#### **NOTE**

- Once this function is enabled, you can only start a cycle from the LG ThinQ smartphone application. If the cycle is not started, the appliance will wait to start the cycle until it is turned off remotely from the application or this function is disabled.
- If the door has been opened, you can not start a cycle remotely.

#### **Disable this function manually**

When this function is activated, press and hold the Remote Start button for 3 seconds.

#### **Download Cycle**

You can download new and special cycles that are not included in the basic cycles on the appliance.

Appliances that have been successfully registered can download a variety of specialty cycles specific to the appliance.

Once cycle download is completed in the appliance, the product keeps the downloaded cycle until a new cycle is downloaded.

**NOTE:** Only one downloaded cycle can be stored on the appliance at a time.

#### **RF Radiation Exposure Statement**

This equipment shall be installed and used at a minimum distance of 20 cm from the human body.

#### **Open Source Software Notice Information**

To obtain the source code under GPL, LGPL, MPL, and other open source licenses, that is contained in this product, please visit [opensource.lge.com](https://opensource.lge.com)

In addition to the source code, all referred license terms, warranty disclaimers and copyright notices are available for download.

LG Electronics will also provide open source code to you on CD-ROM for a charge covering the cost of performing such distribution (such as the cost of media, shipping, and handling) upon email request to [opensource@lge.com](mailto:opensource@lge.com). This offer is valid for a period of three years after our last shipment of this product. This offer is valid to anyone in receipt of this information.

## Smart Diagnosis

This feature is only available on models with the  or  logo.

Use this feature to help you diagnose and solve problems with your appliance.

### NOTE

- For reasons not attributable to LGE's negligence, the service may not operate due to external factors such as, but not limited to, Wi-Fi unavailability, Wi-Fi disconnection, local app store policy, or app unavailability.
- The feature may be subject to change without prior notice and may have a different form depending on where you are located.

### Using LG ThinQ to Diagnose Issues

If you experience a problem with your Wi-Fi equipped appliance, it can transmit troubleshooting data to a smartphone using the LG ThinQ application.

- Launch the LG ThinQ application and select the Smart Diagnosis feature in the menu. Follow the instructions provided in the LG ThinQ application.

### Using Audible Diagnosis to Diagnose Issues

Follow the instructions below to use the audible diagnosis method.

- Launch the LG ThinQ application and select the Smart Diagnosis feature in the menu. Follow the instructions for audible diagnosis provided in the LG ThinQ application.

1. Press the POWER button to turn on the appliance.

- Do not press any other buttons.

2. Place the mouthpiece of your smartphone close to the  or  logo.

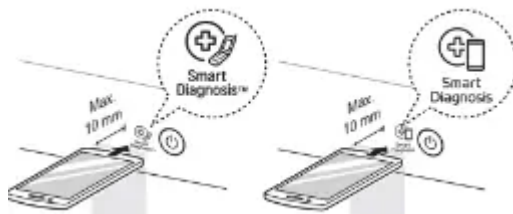

3. Press and hold the Cold Wash button for 3 seconds or longer while holding the smartphone mouthpiece to the logo until the data transfer is complete.

- Keep the smartphone in place until the data transfer has finished. Time remaining for data transfer is displayed.

4. After the data transfer is complete, the diagnosis will be displayed in the application.

**NOTE:** For best results, do not move the smartphone while the tones are being transmitted.

# MAINTENANCE

## WARNING:

- Unplug the appliance before cleaning to avoid the risk of electric shock. Failure to follow this warning may result in serious injury, fire, electric shock, or death.
- Never use harsh chemicals, abrasive cleaners, or solvents to clean the appliance. They may damage the finish.

## Cleaning after Every Wash

### What to Clean

- If you always use cold water, we recommend that a warm or hot wash be used at regular intervals e.g. every 5th wash should be at least a warm one.
- Turn off taps after use to prevent the chance of flooding, otherwise an inlet hose may burst.
- Always unplug the power cord after use.
- After the cycle is finished, wipe the door and the inside of the door to remove any moisture.
- Clean around the bleach dispenser with water to flush any residual bleach from the dispenser opening as bleach can be corrosive if left undiluted.

**WARNING:** Leave the door open to dry the drum interior but only if it is safe and any children are supervised.

### Cleaning the Exterior

Proper care of the appliance can extend the service life.

#### Exterior

- Immediately wipe off any spills.
- Wipe with a damp cloth and then again with a dry cloth ensuring there is no moisture in cabinet joints or crevices.
- Do not press on the surface or the display with sharp objects.

#### Dispenser Drawer

Detergent or fabric softener may build up in the dispenser drawer. Remove the drawer and inserts from the dispenser drawer and clean any buildup once or twice a month.

## Cleaning the Appliance Periodically

### Tub Clean

This function is a special to help to clean the inside of the appliance.

Run this function once a month (or more often if needed) to remove detergent build-up and other residue.

1. Remove any clothing or items from the appliance.
2. Open the dispenser drawer and add anti- limescale to the main wash compartment.
3. Close the dispenser drawer slowly and close the door.
4. Press the POWER button.
5. Press the Program button to select Tub Clean.
6. Press the START/PAUSE button to start.
7. After the cycle is complete, leave the door open in order to allow the appliance door opening, flexible gasket and door glass to dry.

**WARNING:** Leave the door open to dry the drum interior but only if it is safe and any children are supervised.

#### **NOTE**

- Do not add any detergent to the detergent dispenser drawer for this function. Excessive suds may generate and leak from the appliance.
- For models with a lint filter, remove lint or dirt inside the lint filter before and after using this programme.
- For models without a lint filter, the lint is discharged when the water drains during washing.
- After finishing this programme, open the appliance door to remove irritant odour.

#### **Cleaning the Water Inlet Filter**

Water inlet filter collects lime or any small objects that may be in water supplied to the appliance. Clean the water inlet filter regularly.

- Turn off the water taps to the appliance if the appliance is to be left for any length of time (e.g. holiday), especially if there is no floor drain gully in the immediate vicinity.
- IE error message will be displayed on the control panel when water is not entering the detergent drawer.
- If the water is very hard or contains traces of limescale, the filter on the water inlet may be clogged.

1. Turn off the power and the water tap and then unscrew the water inlet hose.

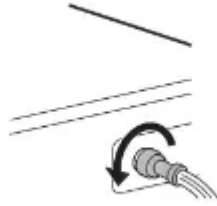

2. Remove the water inlet filter with small pliers and then clean the filter using a medium bristle tooth brush.

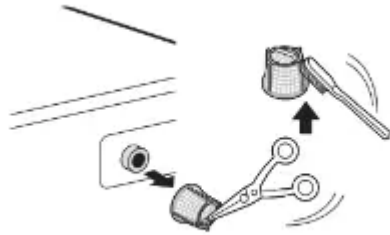

### Caution on Freezing During Winter

When frozen, the appliance does not operate normally. Make sure to install the appliance where it will not freeze during winter.

- In case the appliance must be installed outside on a porch or in other outdoor conditions, make sure to check the following.

### How to Keep the Appliance from Freezing

After closing the tap, disconnect the cold water inlet hose from the tap, and remove water while keeping the hose facing downwards.



### How to Handle Freezing

When water supply problems occur, take the following measures.

- Turn off the tap, and thaw out the tap and both connection areas of water inlet hose of the appliance using a hot water cloth.

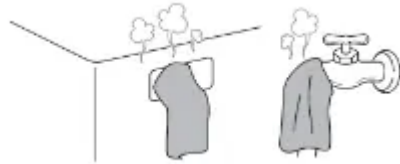

- Take out the water inlet hose and immerse in warm water below 50 - 60 °C.



## TROUBLESHOOTING

### Before Calling for Service

Operation of the appliance can lead to errors and malfunctions. The following tables contain possible causes and notes for resolving an error message or malfunction. You can remedy most of the problems by yourself, consequently save time and money, since you do not need to call LG Electronics service centre. The following table should assist you by troubleshooting.

### Error Messages

The appliance is equipped with an automatic error-monitoring system to detect and diagnose problems at an early stage. If this appliance does not function properly or does not function at all, check the following before you call LG Electronics service centre.

#### **dE DOOR ERROR**

The door is not closed properly.

- Close the door completely. If the error code is still displayed, call for service.

#### **dL DOOR LOCK ERROR**

Door is not locked properly.

- Check nothing is caught under the door, including shipping materials or clothing.
- Close the door completely. If the error code is still displayed, call for service.

#### **dr DRAIN FEATURE**

The appliance is paused during a cycle for a few minutes.

- The cycle will be cancelled and any water remaining in the drum will be drained.

#### **IE INLET ERROR**

Water supply tap(s) are not completely open.

- Fully open tap.

Water supply hose(s) are kinked, pinched, or crushed.

- Straighten or reinstall the water supply hose(s).

The filter of the supply hose(s) are clogged.

- Check and clean the filter of the supply hose(s).

Water supply pressure to tap or house is too low or too high.

- Contact a plumber to have the water pressure checked or restored to the operating requirements.

Water supply is connected with leak limiting hose(s).

- Do not use leak limiting hose(s).

#### **LE | FOREIGN OBJECTS ERROR**

Foreign objects, such as coins, pins, clips, etc., are caught between the pulsator and the inner drum.

- Turn off the appliance and then press the POWER button. Press the Spin button without selecting a cycle to drain and spin the laundry. When the spin is complete, remove the clothes and then find and remove any objects caught in the pulsator gap.

#### **DE | WATER OUTLET ERROR**

Drain hose is kinked, pinched, or clogged.

- Clean and straighten the drain hose.

Drain discharge is more than 1.2 m above the bottom of the appliance.

- Adjust the hose or reconfigure the drain pipe. Maximum drain height is 1.2

#### **UE | UNBALANCE ERROR**

Rebalancing operation is not successful.

- The automatic attempt to rebalance the laundry was not successful. The cycle has been paused to allow the laundry to be manually adjusted.

The load is too small.

- Add more items to allow the appliance to balance the laundry.

Heavy items are mixed with lighter items.

- Wash items of somewhat similar weight.

The load is out of balance.

- Manually redistribute the laundry if laundry have become tangled.

## **EE TEMPERATURE SENSOR ERROR**

Control error.

- Unplug the appliance and wait 60 seconds. Reconnect power and try again.
- If the error code is still displayed, call for service.

## **FE OVERFLOW ERROR**

Water overfills due to the faulty water valve.

- Close the water taps, unplug the appliance, and call for service.

## **PE PRESSURE SENSOR ERROR**

The water level sensor is not working correctly.

- Close the water taps, unplug the appliance, and call for service.

## **LE MOTOR LOCKED ERROR**

A motor error has occurred.

- Allow the appliance to stand for 30 minutes and then restart the cycle.
- If the error code is still displayed, call for service.

## **RE CLUTCH ERROR**

Clutch error.

- Unplug the appliance and call for service. tCL

## **tCL TUB CLEAN ALARM**

The programme has run more than 30 times.

- Run the Tub Clean function.

## **E3 CLOTHES SENSING ERROR**

Sensor for clothes-sensing is defective.

- Manually redistribute the laundry if laundry have become tangled.

Motor's revolution is too low.

Contact-point of Connector is defective.

- Unplug the appliance and wait 60 seconds. Reconnect power and try again.

## **CL CHILD LOCK FUNCTION**

CL is not an error. This prevents children from changing cycles or operating the appliance.

- To deactivate, press the Water Level and Spin buttons simultaneously for 3 seconds.

## Noises

### Rattling and clanking noise

Foreign objects, such as keys, coins, or safety pins may be in the drum.

- Stop the appliance, check the drum for foreign objects. If noise continues after the appliance is restarted, call for service.

### Thumping sound

Heavy laundry may produce a thumping sound. This is usually normal.

- If the sound continues, the appliance is probably out of balance. Stop and redistribute the laundry.

The laundry may be out of balance.

- Pause the cycle and redistribute the laundry after the door unlocks.

### Vibrating noise

Packaging materials are not removed.

- Remove packing materials.

The laundry may be unevenly distributed in the drum.

- Pause the cycle and redistribute the laundry after the door unlocks.

Not all levelling feet are resting firmly and evenly on the floor.

- See the section **Levelling the Appliance** to adjust and level the feet.

Floor is not rigid enough.

- Check if the floor is solid and does not flex. See the section **Installation Place Requirements** to select the proper location.

## Operation

### Water leaking

Water inlet hose connection is loose at tap or appliance.

- Check hoses for leaks, cracks and splits.
- Tighten hose connections.

House drain pipes are clogged.

- The appliance pumps out water very rapidly. Check for water backing up out of the drain pipe during drain. If water is seen coming out of the drain, check for proper drain hose installation and check for restrictions in the drain. Contact a plumber to repair drain pipe.

Drain hose has come out of drain or is not inserted far enough.

- Tie drain hose to supply hose or standpipe to prevent it from coming out during drain. For smaller drain pipes, insert the drain hose into the pipe as far as the drain hose flange. For larger drain pipes, insert the drain hose into the pipe 2.5 - 5 cm past the flange.

A large item such as a pillow or blanket is above the top of the drum.

- Stop the appliance and check the item. Make sure the item does not crest above the top edge of the drum.

**Appliance will not operate.**

Control panel has powered off due to inactivity.

- This is normal. Press the POWER button to turn on the appliance.

Appliance is unplugged.

- Make sure that the cord is plugged securely into a working outlet.

Water supply is turned off.

- Turn on the water supply tap completely.

Controls are not set properly.

- Make sure the cycle is correctly set. Close the door and press the START/ PAUSE button.

Door is open.

- Close the door completely and make sure that nothing is caught at the door.

Circuit breaker/fuse is tripped/blown.

- Check house circuit breakers/fuses. Replace fuses or reset breaker. The appliance should be on a dedicated branch circuit. The appliance will resume the cycle where it stopped once power is restored.

Control needs to be reset.

- Press the POWER button, then reselect the desired programme and press the START/PAUSE button.

START/PAUSE was not pressed after a cycle was set.

- Press the POWER button, then reselect the desired cycle and press the START/ PAUSE button. If the START/PAUSE button is not pressed within a certain time, the appliance will be turned off.

Extremely low water pressure.

- Check another tap in the house to make sure that household water pressure is adequate.

Appliance is too cold.

- If the appliance has been exposed to temperatures below freezing for an extended period of time, allow it to warm up before pressing the POWER button.

Appliance is heating the water or making vapour. (some models only)

- The drum in the appliance may stop operating temporarily during certain cycles, while water is safely heated to a set temperature.

**Appliance is not filling properly.**

Filter is clogged.

- Make sure the inlet filters on the fill valves are not clogged.

Supply hoses may be kinked.

- Check that supply hoses are not kinked or clogged.

Insufficient water supply.

- Make sure that both hot and cold water taps are turned on all the way.

Hot and cold supply hoses are reversed.

- Check supply hose connections.

**Appliance will not drain water.**

Drain hose is kinked.

- Ensure that the drain hose is not kinked.

Drain is located higher than 1.2 m above the floor.

- Make sure that the drain hose is no higher than 1.2 m above the bottom of the appliance.

**Detergent is not dispensed completely or not dispensed at all.**

Too much detergent is used.

- Follow the guidelines provided by the detergent manufacturer.

**Cycle time is longer than usual.**

The load is too small.

- Add more items to allow the appliance to balance the laundry.

Heavy items are mixed with lighter items.

- Always try to wash items of somewhat similar weight to allow the appliance to evenly distribute the weight of the laundry for spinning.

The load is out of balance.

- Manually redistribute the laundry if laundry have become tangled.

## **Performance**

### **Poor stain removal**

Proper options are not selected.

- Heavier soils and tougher stains may require extra cleaning power. Select the Soak option to boost the cleaning power of the selected cycle.

Previously set stains.

- Items that have previously been washed may have stains that have been set. These stains may be difficult to remove and may require hand washing or pretreating to aid in stain removal.

### **Staining**

Bleach or softener dispensed too soon.

- Dispenser compartment is overfilled causing bleach or softener to dispense immediately. ALWAYS measure bleach to prevent overfilling.
- Close the dispenser drawer gently.

Bleach or softener was added directly to the laundry in the drum.

- Always use the dispensers to ensure that laundry products are properly dispensed at the right time in the cycle.

Clothes were not properly sorted.

- Always wash dark colours separately from light colours and whites to prevent discolouration.
- Never wash heavily soiled items with lightly soiled items.

### **Wrinkling**

Appliance is not unloaded promptly.

- Always remove items from the appliance as soon as the cycle is complete.

Appliance overloaded.

- The appliance can be fully loaded, but the drum should not be tightly packed with items. The door of the appliance should be closed easily.

Hot and cold water supply hoses are reversed.

- Hot water rinse can set wrinkles in clothes. Check the supply hose connections.

### **Musty or mildewy odour in the appliance**

Inside of drum was not cleaned properly.

- Run the Tub Clean function regularly.

## **Wi-Fi**

### **Your home appliance and smartphone are not connected to the Wi-Fi network.**

The password for the Wi-Fi that you are trying to connect to is incorrect.

- Find the Wi-Fi network connected to your smartphone and remove it, then register your appliance on LG ThinQ.

Mobile data for your smartphone is turned on.

- Turn off the Mobile data of your smartphone and register the appliance using the Wi-Fi network.

The wireless network name (SSID) is set incorrectly.

- The wireless network name (SSID) should be a combination of English letters and numbers. (Do not use special characters.)

The router frequency is not 2.4 GHz.

- Only a 2.4 GHz router frequency is supported. Set the wireless router to 2.4 GHz and connect the appliance to the wireless router. To check the router frequency, check with your Internet service provider or the router manufacturer.

The distance between the appliance and the router is too far.

- If the distance between the appliance and the router is too far, the signal may be weak and the connection may not be configured correctly. Move the location of the router so that it is closer to the appliance.

### **Warning**

This content is compiled from multiple sources and is provided for reference purposes only. It may not be complete or fully applicable to all situations. If you are unable to resolve your issue, please contact the product manufacturer or an authorized service provider for official support.