

Using the dishwasher

Check the Water Temperature

The entering water should be at least 120°F (49°C) and not more than 150°F (66°C) for effective cleaning and to prevent dish damage. Check the water temperature with a candy or meat thermometer. Turn on the hot water faucet nearest the dishwasher, place the thermometer in a glass and let the water run continuously into the glass until the temperature stops rising.

Use a Rinse Agent such as Cascade® Rinse Aid™

Filling the Dispenser: The rinse agent dispenser holds 3.5 oz. (100 ml) of rinse agent. Under normal conditions, this will last approximately one month.

1. Make sure the dishwasher door is fully open.
2. Open the RINSE AID dispenser door.
3. Slowly add rinse agent until the fill cup is full. May need to pause several times to allow rinse aid to settle.
4. Clean up any spilled rinse agent with a damp cloth.
5. Close the RINSE AID dispenser door.



Rinse Aid Setting: The amount of rinse agent released into the final wash can be adjusted. The factory setting is at the midpoint. If hard water spots appear on dishes, try a higher setting. If you see foam in the dishwasher, move the indicator to a lower setting.



To adjust the setting: Open the RINSE AID dispenser door; then turn the adjuster clockwise to increase the amount of rinse agent, counterclockwise to reduce the amount of rinse agent.



Detergent Dispenser

The detergent dispenser is located in the center of the dishwasher door. It has two compartments. The main wash compartment is found inside the detergent dispenser. To open, press the blue button on the side of the dispenser. The pre-wash compartment is on the lid of the detergent dispenser. Use the pre-wash compartment only when your water is extremely hard or when you have a heavy soiled load.

NOTE: Do not block detergent dispenser with large or tall utensils.



You may use tablet, powder, liquid or gel automatic dishwasher detergent. Make sure you use only detergents specifically labeled for use in automatic dishwashers. Never use liquid hand dish detergent in an automatic dishwasher. Sudsing and poor wash performance will result with the use of improper detergents.

Detergents should be stored in a dry location and in their original container to prevent loss of effectiveness. Place detergent in the cup just prior to starting the dishwasher and then close the cover. The cover will open during the wash cycle.

Filling the Detergent Dispenser

GE recommends using detergent in tablet or packet form. Independent testing has shown this form of detergent is very effective in the dishwasher. Cascade® Platinum Pacs are an example of this type of detergent. Simply put a tablet or packet into the main wash compartment and slide to close the detergent cup cover. Please notice that the tablet or packet must be placed in the main wash compartment of the detergent cup. If the tablet or packet is tossed in the bottom of the dishwasher, the detergent will be flushed down the drain in a very short period of time and will thus be wasted. Wash performance will be very poor as a result. If you choose to use detergent in powder, liquid or gel form, the amount of detergent you use will be determined by the hardness of your water, the temperature of your water, and the food soil load inside the dishwasher. Contact your water company to get information about the hardness of the water in your area. Water hardness is measured in grains per gallon. Use this information and the table above to determine the amount of detergent to use.

<i>Number of Grains/Gal.</i>	<i>Detergent Cups to Fill</i>
Less than 4	Fill cup to 1/3 full
4 to 8	Fill cup to 2/3 full
8 to 12	Fill cup completely full
Greater than 12	Fill both main wash cup and pre wash cup



Using too much detergent with very soft and/or very hot water may cause a condition called etching on your glassware. Etching is a permanent cloudiness in your glassware. This condition is irreversible. However, using too little detergent will cause poor wash performance.

Use the table as a starting point and then adjust the amount of detergent you use. Use just enough to get good wash performance. Using just the right amount of detergent will provide great wash performance without wasting detergent or etching of glassware.

DO NOT USE HAND DISH DETERGENT

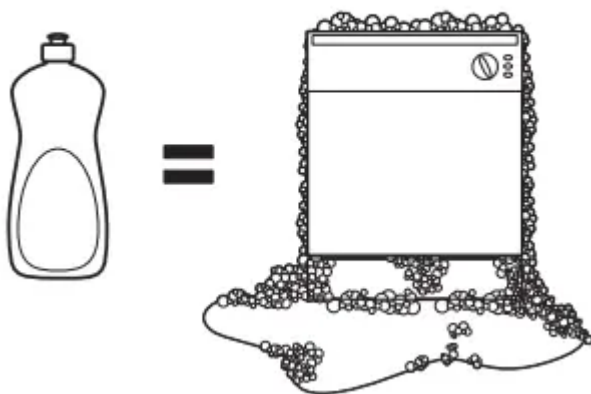

NOTE: Using a detergent that is not specifically designed for dishwashers will cause the dishwasher to fill with suds. During operation, these suds will spill out of the dishwasher vents, covering the kitchen floor and making the floor wet.



Because so many detergent containers look alike, store the dishwasher detergent in a separate space from all other cleaners. Show anyone who may use the dishwasher the

correct detergent and where it is stored. While there will be no lasting damage to the dishwasher, your dishes will not get clean using a dishwashing detergent that is not formulated to work with automatic dishwashers.

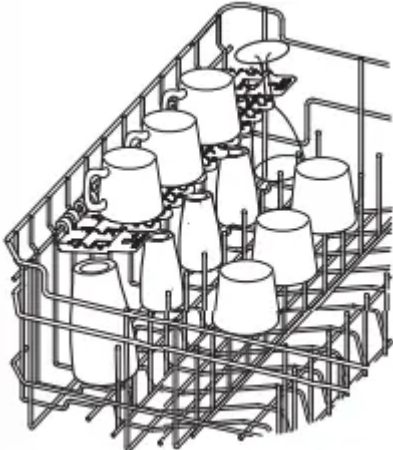
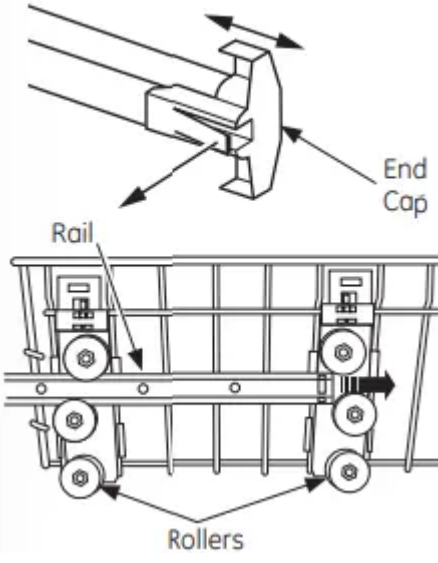

Loading and place settings.

Upper Rack

	<p>The upper rack is primarily for glasses, cups, and saucers. However, other items such as pots, pans, and plates may be placed in the upper rack. This is also a secure place for dishwasher-safe plastic items. The upper rack can be used for odd sized utensils. Sauce pans, mixing bowls, and other similarly shaped items should be placed face down for best wash performance. Ensure small plastic items are secure so that they cannot fall into the heater at the bottom of the dishwasher, potentially damaging the item.</p>
	<p>On some models, the upper rack may be adjusted to accommodate larger items. To adjust the upper rack, fully extend the upper rack and remove the two plastic end caps on the front of the rails. Remove the upper rack. Select the set of rollers on the side of the rack that provides the desired height, and reinstall the upper rack by guiding the rack rails between the appropriate set of rollers. With the rack reinstalled, replace the two plastic end caps, ensuring the snap is properly engaged. Failure to properly engage the end caps may result in the rack falling from the dishwasher.</p>
	<p>To add flexibility in loading, the utility shelf (on some models) may be placed in the up or down position. The shelf may also be used to secure stemware such as wine glasses. Because these stemware items come in various sizes, slowly push the rack in to ensure the items do not bump into the edges of the dishwasher, which may cause damage to the items.</p>



It is important to ensure that items do not protrude through the bottom of the rack or silverware basket (on some models) where they will block the rotation of the middle spray arm. This could result in noise during operation and/or poor wash performance.

Check to make sure that no items will block rotation of the wash arms.



	<p>The Bottle Jets system (on some models) is the ideal location to position tall cups, sports bottles, and baby bottles. The Bottle Jets clips hold bottles with small openings in place so water jets are directed inside to clean hard to reach areas. Clips can be installed or removed by simply slipping the clip opening over the top of the nozzle.</p>
--	---



Sports bottle held in place over a Bottle Jets clip



Baby bottle held in place under a Bottle Jets clip

Upper Rack - 8 Place Settings
GDF510-610, GDT535-545, GDT625
& ADT521



Upper Rack - 10 Place Settings
GDF510-610, GDT535-545, GDT625
& ADT521



Upper Rack - 12 Place Settings
GDF510-610, GDT535-545, GDT625
& ADT521



Upper Rack - 8 Place Settings
GDF620 & GDT635



Upper Rack - 10 Place Settings
GDF620 & GDT635



Upper Rack - 12 Place Settings
GDF620 & GDT635



Lower Rack



The lower rack is best used for plates, saucers and cookware items. Large items, such as broiler pans and baking racks should go along the sides of the rack. If necessary, oversized glasses and mugs can be placed in the lower rack to maximize loading flexibility. Plates, saucers and similar items should be placed between the tines in the direction that allows the item to remain secure in the rack. It is important to ensure that items do not protrude through the bottom of the rack or the silverware basket where they will block the rotation of the lower spray arm. This could result in noise during operation and/or poor wash performance.

**Lower Rack - 8 Place Settings
GDF510 & GDT535**



**Lower Rack - 10 Place Settings
GDF510 & GDT535**



**Lower Rack - 12 Place Settings
GDF510 & GDT535**



**Lower Rack - 8 Place Settings
GDF520, GDF610, ADT521, GDT545
& GDT625**



**Lower Rack - 10 Place Settings
GDF520, GDF610, ADT521, GDT545
& GDT625**

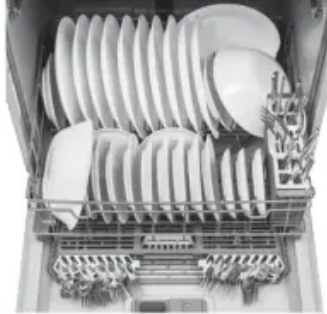

**Lower Rack - 12 Place Settings
GDF520, GDF610, ADT521, GDT545
& GDT625**

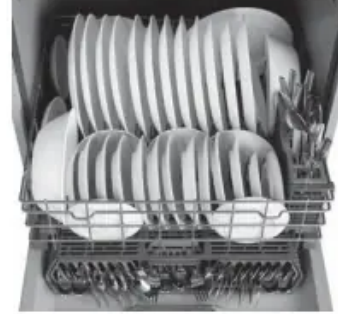

**Lower Rack - 8 Place Settings
GDF620 & GDT635**



**Lower Rack - 10 Place Settings
GDF620 & GDT635**

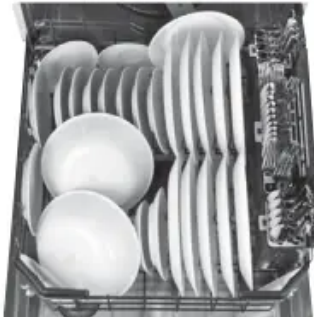

**Lower Rack - 12 Place Settings
GDF620 & GDT635**

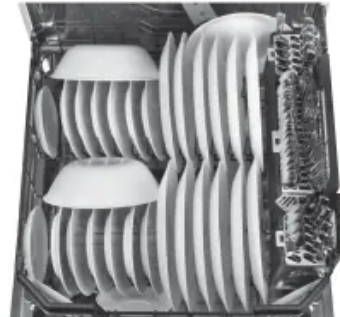

Loading the silverware baskets...

Silverware Basket

 <p>A line drawing showing a hand placing a silverware basket into a dishwasher rack. The basket is being inserted into a slot. Two small circular components, labeled 'Mounting Bosses', are visible on the side of the rack. The basket itself is labeled 'Silverware Basket'.</p>	<p>Place flatware in the removable silverware and accessory baskets (on some models). Sharp objects, such as forks and knives, may be placed with the handles facing up, in order to protect your hands. For the best wash performance, place other items such as spoons with the handles facing down. Avoid allowing items to nest together, which may keep them from being properly washed. When loading, distribute items evenly in the basket.</p>
 <p>A line drawing showing a silverware basket being secured to a dishwasher rack. The basket is shown in a perspective view, and a wire loop is being used to secure it to the rack. The basket is labeled 'Silverware Basket' and the wire loop is labeled 'Wire Loops'.</p>	<p>The silverware and accessory baskets (on some models) may also be used for small items, such as measuring spoons, baby bottle nipples, plastic lids, or corn cob holders. The silverware basket covers (on some models) can be closed to contain small items.</p> <p>The door mounted silverware basket (on some models) may be positioned either on the door by securing the basket to the door using the two mounting bosses, or to the rack by securing the basket to the rack using the wire loop on the front of the lower rack to engage the tabs on the rear of the basket.</p>

The accessory basket (on some models) may be positioned by placing the hooks on the back of the basket over the top wire on the sides of the lower rack.

Secure the basket to the rack using the wire loop on the front of the upper and lower racks to engage the tabs on the rear of the basket.

Do not load large or tall utensils where they may block the detergent dispenser or become trapped between the door and the gasket when the door is closed.



*Silverware Basket - 8 Place Settings
GDF510 & GDT535*



*Silverware Basket - 10 Place Settings
GDF510 & GDT535*



*Silverware Basket - 12 Place Settings
GDF510 & GDT535*



*Silverware Basket - 8 Place Settings
GDF520, GDF610, GDT545, GDT625 & ADT521*



*Silverware Basket - 10 Place Settings
GDF520, GDF610, GDT545, GDT625 & ADT521*



*Silverware Basket - 12 Place Settings
GDF520, GDF610, GDT545, GDT625 & ADT521*



*Silverware Basket - 8 Place Settings
GDF620 & GDT635*



*Silverware Basket - 10 Place Settings
GDF620 & GDT635*



*Silverware Basket - 12 Place Settings
GDF620 & GDT635*



Care and cleaning

Cleaning the Exterior Door Panel

Before cleaning the front panel, make sure you know what type of panel you have. Refer to the last two letters of your model number. You can locate your model number on the left-hand tub wall just inside the door. If your model number ends with BB, CC, WW, SA or ES then you have a painted door panel. If your model number ends with SS, then you have a Stainless Steel door panel. If your model number ends with II, then you have an Integrated door panel. Follow the instructions below for cleaning the door panel for your specific model.

Painted Door Panel (model numbers ending in BB–black, CC–bisque, WW–white, SA–silver or ES–slate) Use a clean, soft, lightly dampened cloth, then dry thoroughly. You may also use a good appliance wax or polish. Do not use scouring pads or powered cleaners because these products can scratch the finish.

Stainless Steel Door Panel (model numbers ending in SS)

For cleaning rust and tarnish, cleaners with oxalic acid such as Bar Keepers Friend Soft Cleanser™ will remove rust, tarnish and small blemishes. Use only a liquid cleanser free of grit and rub in the direction of the brush lines with a damp soft sponge. Do not use appliance wax or polish on the stainless steel.

For other blemishes and marks, use Stainless Steel Magic or a similar product using a clean soft cloth. Do not use appliance wax, polish, bleach or products containing chlorine on Stainless Steel. You can order Stainless Steel Magic™ # WX10X29 through GE Parts by calling 877.959.8688. In Canada, call 1-800- 661-1616.

Integrated Door Panel (model numbers ending in II) This is a custom installed door panel, and you will need to refer to the cabinet manufacturers recommendations for proper cleaning.

Cleaning the Control Panel

To clean the control panel, use a lightly dampened cloth. Then dry thoroughly

Cleaning the Dishwasher Interior

To clean and de-odorize your dishwasher, use citric acid or Lemi Shine®*, a detergent additive. Lemi Shine will break up mineral deposits, and remove hard water film and stains. You can order citric acid #WD35X151 through GE Parts by calling 877-959-8688 or visiting GEApplianceparts.com. In Canada, call 1-800-661-1616. You can purchase Lemi Shine at your local grocery store or by calling GE at the numbers above and ask for WX10X10019.

Stainless Steel Inner Door

The stainless steel used to make the dishwasher inner door provides the highest reliability available in a GE dishwasher.

If the dishwasher inner door should be scratched or dented during normal use, it will not rust or corrode. These surface blemishes will not affect its function or durability.

Cleaning the Filters

Inspect and clean the filters periodically. This should be done every other month or so depending on usage. If there is a decrease in wash performance or dishes feel gritty, this is also an indication the filters need to be cleaned.

Ultra-Fine Filter

To clean the Ultra-Fine Filter, remove the bottom rack. Twist counterclockwise and remove the Ultra-Fine Filter. Rinse filter with warm soapy water and use a sponge to carefully remove any stubborn particles. Scrubbing with scouring pads or brushes can damage the filter. Once cleaned, replace the Ultra-Fine Filter, and twist clockwise to lock in place.

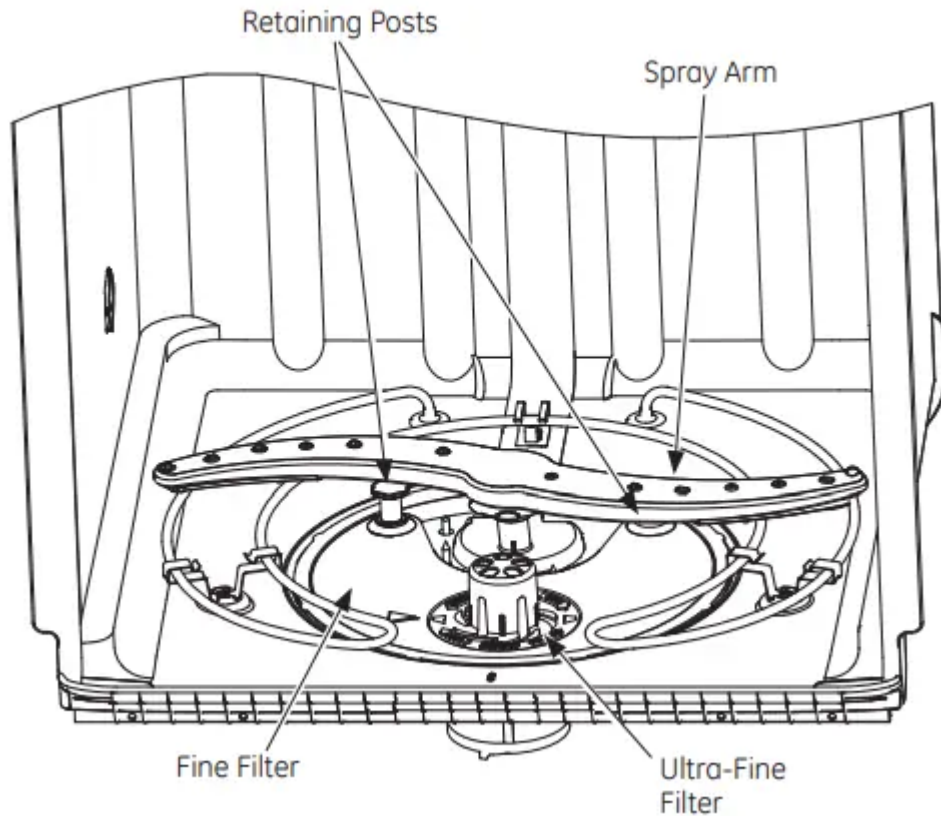

Fine Filter

To clean the Fine Filter (mesh plate), remove the bottom rack. Remove the Ultra-Fine Filter. Twist counterclockwise each of the two retaining posts located toward the back bottom of the tub, and remove the Fine Filter. Rinse filter with warm soapy water. Scouring pads or brushes can scratch the filter surface but a soft brush or sponge may be needed to remove stubborn soils or calcium deposits caused by hard water. Once cleaned, replace the Fine Filter, the Ultra-Fine Filter, and twist clockwise the two retaining posts into place.

Protect Against Freezing

If your dishwasher is left in an unheated place during the winter, ask a service technician to:

1. Turn off electrical power to the dishwasher. Remove fuses or trip circuit breaker.
2. Turn off the water supply and disconnect the water inlet line from the water valve.
3. Drain water from the water inlet line and water valve. (Use a pan to catch the water.)
4. Reconnect the water inlet line to the water valve.

Does Your Dishwasher Have an Air Gap?



An air gap protects your dishwasher against water backing up into it if a drain clogs. The air gap is not a part of the dishwasher. It is not covered by your warranty. Not all plumbing codes require air gaps, so you may not have one.

The air gap is easy to clean.

1. Turn off the dishwasher and lift off the air gap cover.
2. Remove the plastic cap under the cover and clean with a toothpick.
3. Replace the cap and cover when the air gap is clean.

Troubleshooting Tips

Problem	Possible Causes	What To Do
Start Status indicator light flashing	The door was opened or the cycle was interrupted.	<ul style="list-style-type: none"> • Press the Start pad once to start the dishwasher. Press the Start pad a second time when the dishwasher is running only if you wish to cancel the cycle.
Dishwasher BEEPS once every minute	This is a reminder that your dishwasher door has been left open during operation. It will continue beeping until you press Start and close the door.	<ul style="list-style-type: none"> • Press Start and close the door.
Beeping at the end of the cycle	This is normal. The dishwasher will beep twice at the end of the cycle.	<ul style="list-style-type: none"> • To turn off the double beep indicator (or re-activate it if it was previously turned off), press the Heated Dry pad 5 times within 3 seconds. A triple beep will sound to indicate the end-of-cycle beep option has been turned on or off.
Dishes and flatware not clean	Ultra fine or fine filter is clogged	<ul style="list-style-type: none"> • See the Care and cleaning section
	Low inlet water temperature	<ul style="list-style-type: none"> • Make sure inlet water temperature is correct (see the Using the dishwasher section). Turn on the hot water faucet nearest the dishwasher, let run until the water temperature stops rising. Then start the dishwasher and turn off the faucet. This ensures the entering water is hot. Select Wash Temp Boost if available.
	Water pressure is temporarily low	

Problem	Possible Causes	What To Do
		<ul style="list-style-type: none"> • Turn on a faucet. Is water coming out more slowly than usual? If so, wait until pressure is normal before using your dishwasher.
	Air gap or disposer is clogged	<ul style="list-style-type: none"> • Clean the air gap or flush the disposer.
	Improper rack loading	<ul style="list-style-type: none"> • Make sure large dishware does not block the detergent dispenser or the wash arms. See the Loading the dishwasher racks section. • When large utensils are placed in the silverware basket, do not mount the basket on the door (on some models). Instead, mount basket on the lower rack.
	Poor performing detergent	<ul style="list-style-type: none"> • Use a highly rated detergent such as Cascade Complete® All-in-1 ActionPacs™. Spot
Spots and filming on glasses and flatware	Extremely hard water	<ul style="list-style-type: none"> • Use rinse agents such as Cascade® Rinse Aid™ to remove spots and prevent new film buildup. • If water is extremely hard, a softener may be required
	Low inlet water temperature	<ul style="list-style-type: none"> • Make sure water temperature is at least 120°F.
	Overloading or improper loading of the dishwasher	<ul style="list-style-type: none"> • Load dishwasher as shown in the Loading Place Settings section.
	Old or damp powder detergent	<ul style="list-style-type: none"> • Make sure detergent is fresh.



Problem	Possible Causes	What To Do
	Rinse agent dispenser empty	<ul style="list-style-type: none"> • Refill with rinse agent such as Cascade ® Rinse Aid™
	Too little or low performing detergent	<ul style="list-style-type: none"> • Make sure you use the proper amount of highly rated detergent.
Cloudiness on glassware	Combination of soft water and too much detergent	<ul style="list-style-type: none"> • This is called etching and is permanent. To prevent this from happening, use less detergent if you have soft water. Wash glassware in the shortest cycle that will get it clean.
	Low performing phosphate free detergent .	<ul style="list-style-type: none"> • See A white film on glassware, dishware and the interior in this Troubleshooting section
	Water temperature entering the dishwasher exceeds 150°F (66°C)	<ul style="list-style-type: none"> • This could be etching. Lower the water heater temperature
Suds in the tub	Correct detergent wasn't used 	<ul style="list-style-type: none"> • Use only automatic dishwasher detergents to avoid sudsing. Cascade® Automatic Dishwashing Detergents have been approved for use in all GE dishwashers.
	Rinse agent was spilled	Always wipe up rinse agent spills immediately
Detergent left in dispenser cups	Dishes or utensils are blocking the detergent cup	<ul style="list-style-type: none"> • Reposition the dishes, so the water from the lower spray arm can flush the detergent cup. See the Loading the dishwasher racks section. • Reposition the tall utensils or heavy silverware that may be keeping the dispenser cup door

Problem	Possible Causes	What To Do
		from opening. See the Loading the silverware basket section.
Black or gray marks on dishes	Aluminum utensils have rubbed against dishes	<ul style="list-style-type: none"> • Remove marks with a mild, abrasive cleaner.
Dishes don't dry	Low inlet water temperature	<ul style="list-style-type: none"> • Make sure inlet water temperature is at least 120°F. • Select Heated Dry. • Use Wash Temp Boost option. • Select a higher cycle, such as Wash Temp Sani (Sanitize) or Heavy
	Rinse agent dispenser is empty	<ul style="list-style-type: none"> • Check the rinse agent dispenser and fill as required.
	Cycle selection	If using Light Cycle which uses lower water temperature and thus limited dry performance, switch to a different cycle.
	Cycle completion	Allow cycles to fully complete. See Long Cycle Times in this Troubleshooting section
Control panel responded to inputs but dishwasher never filled with water	Door may not be completely closed	<ul style="list-style-type: none"> • Make sure the door is firmly closed.
	Water valve may be turned off	<ul style="list-style-type: none"> • Make sure water valve (usually located under the sink) is turned on.

Problem	Possible Causes	What To Do
Stained tub interior	Some tomato-based foods can	<ul style="list-style-type: none"> • Use of the Steam cycle (on some models) after adding the dish to the load cause reddish stains can decrease the level of staining.
	Tea or coffee stains	<ul style="list-style-type: none"> • Remove the stain by hand, using a solution of 1/2 cup bleach and 3 cups warm water. NOTE: Do not use bleach on stainless steel tub or inner door.
	An overall yellow or brown film can be caused by iron deposits in water	<ul style="list-style-type: none"> • A special filter in the water supply line is the only way to correct this problem. Contact a water softener company.
	White film on inside surface-hard water minerals	<ul style="list-style-type: none"> • GE recommends Cascade® Rinse Aid™ to help prevent hard water mineral deposits from forming. • Run dishwasher with citric acid to remove mineral deposits. Citric acid (Part number: WD35X151) can be ordered through GE Parts. See back cover for ordering information.
Dishwasher won't run	Fuse is blown or circuit breaker is tripped	Replace fuse or reset circuit breaker. Remove any other appliances from the circuit.
	Power is turned off	<ul style="list-style-type: none"> • In some installations, the power to the dishwasher is provided through a wall switch, often located next to the disposer switch. Make sure it is on.
	Control panel is locked	<ul style="list-style-type: none"> • Unlock control panel. See the Getting started section.
Control panel lights go off		

Problem	Possible Causes	What To Do
when you're setting controls	Time too long between touching of selected pads	<ul style="list-style-type: none"> • Each pad must be touched within 30 seconds of the others. To relight, touch any pad again or open the door and unlock (top control).
Water standing in the bottom of the tub	Air gap is clogged	<ul style="list-style-type: none"> • Clean the air gap. See the Care and cleaning section.
Water won't pump out of the tub	Drain is clogged	<ul style="list-style-type: none"> • If you have an air gap, clean it. See the Care and cleaning section. • If the dishwasher drains into a disposer, run disposer clear. • Check to see if your kitchen sink is draining well. If not, you may need a plumber.
Steam	This is normal	<ul style="list-style-type: none"> • Warm, moist air comes through the vent during drying and when water is being pumped out. This is necessary for drying.
Sanitized light does not illuminate at the end of the cycle	The door was opened and the cycle was interrupted during final rinse	<ul style="list-style-type: none"> • Do not interrupt the cycle by opening the door during the wash cycle.
	The incoming water temperature was too low	<ul style="list-style-type: none"> • Do not interrupt the cycle by opening the door during the wash cycle.
Noise	Normal operating sounds: Detergent cup opening	<ul style="list-style-type: none"> • These are all normal. No action is required.

Problem	Possible Causes	What To Do
	<p>Water entering dishwasher</p> <p>The motor stops and starts at various times during the cycle</p> <p>Spray arms start and stop at various times</p> <p>Drain pump sounds during pump out</p> <p>Drain pump starts and stops several times during each drain</p>	
	<p>Rattling dishes when the spray arm rotates</p>	<ul style="list-style-type: none"> • Make sure dishes are properly loaded. See the Loading the dishwasher racks section. Ensure dishes do not extend below rack, so they do not contact the spray arm as it rotates
	<p>Rattling silverware against door during wash</p>	<ul style="list-style-type: none"> • Tall utensils may be placed in the upper rack to avoid bumping against inner door during wash cycle.
<p>A white film on glassware, dishware and the interior</p>	<p>This problem caused by phosphate-free dishwasher detergent</p>	<ul style="list-style-type: none"> • To remove the white film, run your dishes through a dishwasher cycle with citric acid. Use a WD35X151 citric acid kit found online. • Pour the citric acid in the detergent cup and close the cover. Place the filmed but otherwise clean glassware and dishware in the dishwasher. Leave silverware and other metal items out of the dishwasher. Turn the dishwasher on and let it run through a complete



Problem	Possible Causes	What To Do
		<p>cycle without detergent. The glassware, dishware, and dishwasher should come out film free. Alternatively, a vinegar rinse may be used. Pour 1 cup of vinegar into dishwasher just after the detergent cup opens and let the dishwasher complete its cycle. This may be repeated several times a year as needed. The use of a rinse agent such as Cascade® Rinse Aid™ may help minimize a repeat build up of film. Also, the use of a highly rated detergent such as Cascade Complete® All-in-1 ActionPacs™ will help prevent film build-up.</p>
<p>Long cycle times</p>	<p>Dishwasher washes by alternating mid and lower spray arms</p>	<ul style="list-style-type: none"> • Longer cycles are normal. For best wash and dry performance, let cycle complete
	<p>Soil level</p>	<ul style="list-style-type: none"> • The turbidity sensor senses how much soil is on the dishes. Heavy soiled dish loads will add more time to the cycle. This is normal function. For best wash and dry performance, allow cycle to complete.

Warning

This content is compiled from multiple sources and is provided for reference purposes only. It may not be complete or fully applicable to all situations. If you are unable to resolve your issue, please contact the product manufacturer or an authorized service provider for official support.

