

OPERATING INSTRUCTIONS

Features

French Door Models

1 Space-saving icemaker (on some models)

Icemaker and bin are located on the door creating more usable storage space.

2 LED lighting

LED lights in the fresh food compartment are located at the top center and on the left and right sides of climate zone pans. LED lights are also located in the freezer

3 Full-width drawer

A full-width drawer that can accommodate larger items is located at the bottom of the fresh food compartment.

4 QuickSpace™ shelf (on some models)

Functions as a normal full-sized shelf when needed and easily slides back to store tall items below.

5 Removable/adjustable door bins

Can be moved up or down to accommodate your needs.

6 Climate zone drawers

Separate pans for produce storage.

7 Water filter

Accessible for easy replacement.

Single Door Models

1 Floating snack pan

Can be moved to different locations to best serve your needs.

2 LED lighting

LED light is located at the top of the fresh food compartment. LED lights are also located in the freezer

3 Full-width shelves

Full-width shelves that can accommodate larger items.

4 Full-width gallon door bins

Nonadjustable full-width door bins that will hold gallon containers.

5 Climate zone pans

Separate bins for produce storage.

6 Water filter (on some models)

Accessible for easy replacement.

7 Adjustable door bins

Can be moved up or down to accommodate your needs.

8 Icemaker (on some models)

Icemaker is located in the freezer on some models. Icemaker Kit IM4D is available for models that are icemaker-ready. For installation instructions see the IM4D owner's manual

Controls

1 Freezer Compartment Temperature Control

Adjust freezer compartment temperature. The freezer temperature is preset in the factory at the Colder position. Allow 24 hours for temperature to stabilize to the preset recommended setting.

2 Fresh Food Compartment Temperature Control

Adjust fresh food compartment temperature. The fresh food temperature is preset in the factory at the Colder position. Allow 24 hours for temperature to stabilize to the preset recommended setting.

**GDE21D, GDE21E, PDE21K, GDE25E, GNE21D, GNE21F, PNE21K, PNE21N,
GWE19J, GNE25D, GNE25J, PNE25J, CNE25S, PNE25N, GNE27J, GNE27E**

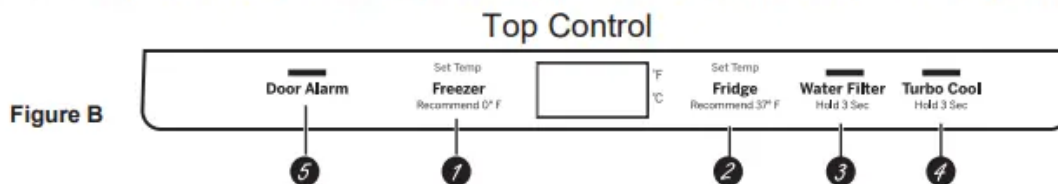

1 Freezer Compartment Temperature Control

Adjust freezer compartment temperature. The freezer temperature is preset in the factory at 0°F (-17.8°C). Allow 24 hours for temperature to stabilize to the preset recommended setting.

2 Fresh Food Compartment Temperature Control

Adjust fresh food compartment temperature. The fresh food temperature is preset in the factory at 37°F (2.8°C). Allow 24 hours for temperature to stabilize to the preset recommended setting.

3 Water Filter

Press and hold 3 seconds to reset the Water Filter.

4 Turbo Cool

To set the TurboCool™, press the Turbo Cool pad for 3 seconds. The display will show tc. TurboCool™ rapidly cools the refrigerator compartment in order to more quickly cool foods. Use TurboCool™ when adding a large amount of the food to the refrigerator compartment, putting away foods after they have been sitting out at room temperature, or when putting away warm leftovers. It can also be used if the refrigerator has been without power for an extended period.

NOTE: The refrigerator temperature cannot be changed during TurboCool™. The freezer temperature is not affected during Turbo Cool. When opening the refrigerator door during TurboCool™, the fans will continue to run if they have cycled on.

5 Door Alarm

To set the alarm, press the Door Alarm pad. This alarm will sound if either door is open for more than 2 minutes. The beeping stops when you close the door.

NOTE: To put the refrigerator control in the OFF position, simultaneously touch the words Freezer and Fridge for 3 seconds. Power to the refrigerator cannot be disconnected by any setting on the control panel.

6.Lock

Press and hold the Lock pad for 3 seconds to lock out ice and water dispenser and all other controls. Press and hold to unlock the controls.

7.LED dispenser Light

Press the Light pad to turn your dispenser light on and off.

Changing °F to °C or °C to °F: Press and hold the "DOOR ALARM" and "FREEZER" buttons simultaneously for 5 seconds to set °C to °F or °F to °C.

GYE18J, PYE18H, GFE24J, PFE24J, CFE24S, PFE24H, GFE26J External Control

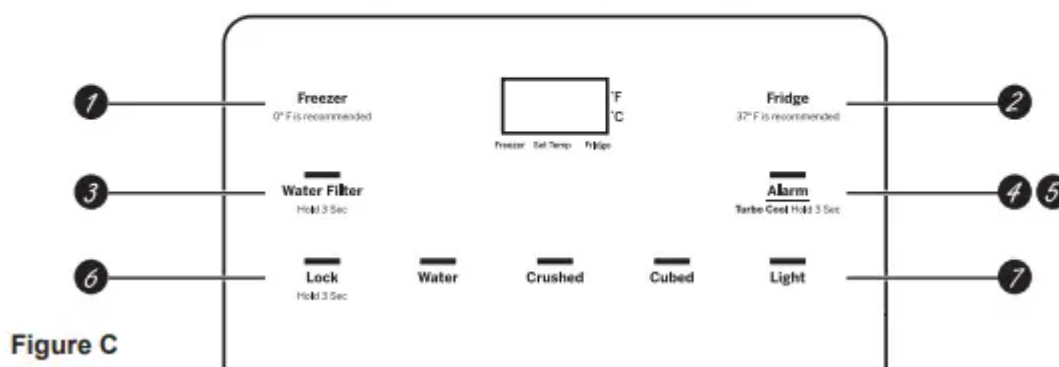

Figure C

1 Freezer Compartment Temperature Control

Adjust freezer compartment temperature. The freezer temperature is preset in the factory at 0°F (-17.8°C) . Allow 24 hours for temperature to stabilize to the preset recommended setting.

2 Fresh Food Compartment Temperature Control



Adjust fresh food compartment temperature. The fresh food temperature is preset in the factory at 37°F (2.8°C). Allow 24 hours for temperature to stabilize to the preset recommended setting.

3 Filter Status

Press the Filter Status pad to display the water filter's life percentage (%).

4 Turbo Cool

To set the TurboCool™, press the Turbo Cool pad for 3 seconds. The display will show tc. TurboCool™ rapidly cools the refrigerator compartment in order to more quickly cool foods. Use TurboCool™ when adding a large amount of the food to the refrigerator compartment, putting away foods after they have been sitting out at room temperature, or when putting away warm leftovers. It can also be used if the refrigerator has been without power for an extended period.

NOTE: The refrigerator temperature cannot be changed during TurboCool™. The freezer temperature is not affected during Turbo Cool. When opening the refrigerator door during TurboCool™, the fans will continue to run if they have cycled on.

5 Alarm

Press the Alarm pad to toggle the door alarm between off and on. The alarm will sound if either door is left open for more than 2 minutes. The beeping stops when you close the door.

6 Lock

Press and hold the Lock pad for 3 seconds to lock out ice and water dispenser and all other controls. Press and hold to unlock the controls.

7 LED dispenser Light

Press the Light pad to turn your dispenser light on and off.

NOTE: To put the refrigerator control in the OFF position, simultaneously touch the words Freezer and Fridge for 3 seconds. Power to the refrigerator cannot be disconnected by any setting on the control panel.

Changing °F to °C or °C to °F: Press and hold the "ALARM" and "FREEZER" buttons simultaneously for 5 seconds to set °C to °F or °F to °C.

Sabbath Modes (on some models)

Models with Figure B controls

- Press and hold the "DOOR ALARM" and "WATER FILTER" buttons simultaneously for 5 seconds to enter/exit Sabbath Mode.

Models with Figure C controls

- Press and hold the "LOCK" and "LIGHT" buttons simultaneously for 5 seconds to enter/exit Sabbath Mode.

Dispenser (on some models)

Water & Ice Dispenser

Press the glass gently against the dispenser cradle.

The spill shelf is not self-draining. To reduce water spotting, the shelf should be cleaned regularly.

If no water is dispensed when the refrigerator is first installed, there may be air in the water line system. Press the dispenser paddle for at least five minutes to remove trapped air from the water line and to fill the water system. To flush out impurities in the water line, throw away the first six full glasses of water.

To remove Dispenser Tray

- Pull Dispenser Tray out.

To reinstall Dispenser Tray

- Push in until it is firmly in place.

Door Ice Bin

1. Open left fresh food door.
2. Pull down latch to release bin door.
3. Using handhold, lift ice bucket up and out to clear locators in bottom of bin.
4. To replace the ice bucket, set it on the guide brackets and push until the ice bucket seats properly.
5. If bucket cannot be replaced, rotate the Ice Bucket Fork 1/4 turn clockwise.

Internal Water Dispenser (on some models)

The water dispenser is located on the left wall inside the refrigerator compartment.

To dispense water:

1. Hold the glass against the recess.
2. Push the water dispenser button.
3. Hold the glass underneath the dispenser for 2-3 seconds after releasing the dispenser button. Water may continue to dispense after the button is released.

If no water is dispensed when the refrigerator is first installed, there may be air in the water line system. Press the dispenser button for at least 5 minutes to remove trapped air from the water line and to fill the water system. During this process, the dispenser noise may be loud as the air is purged from the water line system. To flush out impurities in the water line, throw away the first 6 glassfuls of water.

NOTE: To avoid water deposits, the dispenser should be cleaned periodically by wiping with a clean cloth or sponge.

Important Facts About Your Dispensers

- Do not add ice from trays or bags to the door icemaker bucket. It may not crush or dispense.
- Avoid overfilling glass with ice and use of narrow glasses. Backed-up ice can jam the chute or cause the door in the chute to freeze shut. If ice is blocking the chute remove the ice bucket, poke it through with a wooden spoon.
- Beverages and foods should not be quick-chilled in the door icemaker bin. Cans, bottles or food packages in the storage drawer may cause the icemaker or auger to jam.
- To keep dispensed ice from missing the glass, put the glass close to, but not touching, the dispenser opening.
- Some crushed ice may be dispensed even though you selected CUBED ICE. This happens occasionally when a few cubes accidentally get directed to the crusher.
- After crushed ice is dispensed, some water may drip from the chute.
- Sometimes a small mound of frost will form on the door in the ice chute. This condition is normal and usually occurs when you have dispensed crushed ice repeatedly.

Water Filter Cartridge - MWF(on some models)

Water Filter Cartridge

The water filter cartridge is located in back upper right corner of the refrigerator compartment.

When to replace the filter on models with a replacement indicator light

There is a replacement indicator light for the water filter cartridge on the dispenser. A red light will start blinking to tell you that you need to replace the filter soon. The filter cartridge should be replaced when the replacement indicator light turns red or if the flow of water to the dispenser or icemaker decreases.

When to replace the filter on models without a replacement indicator light

The filter cartridge should be replaced every six months or earlier if the flow of water to the dispenser or icemaker decreases.

Removing the filter cartridge

If you are relacing the cartridge, first remove the old one by slowly turning it to the left. Do not pull down on the cartridge. A small amount of water may drip down.

NOTE: To reduce the risk associated with property damage due to water leakage, read and follow instructions before installation and use of this system. Installation and use MUST comply with all sate and local plumbing codes.

Installing the Filter Cartridge

1. Fill the replacement cartridge with water from the tap to allow for better flow from the dispenser immediately after installation.
2. Line up the arrow on the cartridge and the cartridge holder. Place the top of the new cartridge up inside the holder. Do not push it up into the holder.
3. Slowly turn it to the right until the filter cartridge stops. **DO NOT OVERTIGHTEN**. As you turn the cartridge, it will automatically raise Cartridge itself into position. The cartridge will Holder move about a 1/2 turn.
4. Run water from the dispenser for 1-1/2 gallons (about three minutes) to clear the system and prevent sputtering.
5. Press and hold the RESET WATER FILTER pad (on some models) on the dispenser for three seconds.

NOTE: A newly installed water filter cartridge may cause water to spurt from the dispenser.

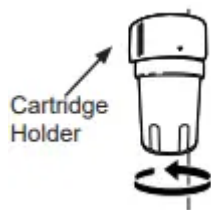

Filter Bypass Plug

You must use the filter bypass plug when a replacement filter cartridge is not available. The dispenser and the icemaker will not operate without the filter or filter bypass plug

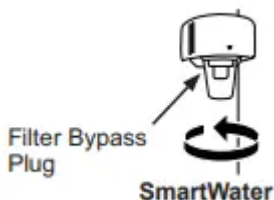

Water Filter Cartridge - XWF (on some models)

WATER FILTER CARTRIDGE

The water filter cartridge holder is located in the back upper-right corner of the fresh food refrigerator compartment.

WHEN TO REPLACE THE FILTER

If there is a replacement indicator light for the water filter cartridge on the dispenser, the red light will start blinking to tell you that you need to replace the filter soon.

- For external control models, the filter light will blink while you are dispensing until the filter is replaced.

- For top control models, the filter light will blink while the door is open until the filter is replaced.

For models that don't have the indicator light, the filter cartridge should be replaced every six months, or earlier if the flow of water to the dispenser or icemaker decreases.

REMOVING THE FILTER

If you are replacing the cartridge, first remove the previous one:

1. Open the filter cartridge housing by squeezing the 2 front tabs and gently pulling down.
2. Rotate the filter down.
3. Gently grasp the filter and slowly turn it counterclockwise about a ¼ turn. The filter should automatically release itself when you have rotated it far enough to the left. A small amount of water may drip down.

FILTER BYPASS PLUG

To reduce the risk of property damage due to water leakage, you **MUST** use the filter bypass plug replacement filter cartridge is not available. Some models do not come equipped with the filter bypass plug. To obtain a free bypass pug, call 800-GECARES. In Canada, call 800.561.3344. The dispenser and icemaker will not operate without either the filter or bypass plug installed. The bypass plug is installed in the same way as a filter cartridge

INSTALLING THE FILTER IN A BOTTOM FREEZER REFRIGERATOR

1. . Open the filter cartridge housing by squeezing the 2 front tabs and gently pulling down.
2. Line up the ports on the filter with the ports on the filter cartridge holder, and gently insert the filter.
3. Slowly turn it to the right until the filter cartridge stops. **DO NOT OVERTIGHTEN**. As you turn the cartridge, it will automatically raise itself into position. . The filter will move about a ¼ turn or 90 degrees, until the arrow on the filter aligns with the arrow on the filter cartridge holder.
4. Slowly push the filter up into the clips.
5. Close the filter cartridge housing by gently pushing the lid upwards until the tabs lock into place.
6. For dispenser-only models - Run water from the dispenser for 2 gallons (7.6 liters) or approximately 5 minutes to clear the system. Water may spurt out and air bubbles may be visible during this process. If water is not flowing, check to make sure the filter has been fully rotated to the right.

For icemaker-only models - Discard the first bin of ice to allow air to purge from the system. A newly installed filter cartridge will cause water to spurt into the icemaker body, which could lead to ice droplets around the icemaker area.

7. Press and hold the **RESET WATER FILTER** button on the dispenser for 3 seconds. On select models, filter reset will be automatic when a new filter is installed.

Shelves and Bins

Not all features are on all models.

Rearranging the Refrigerator Shelves

Shelves in the refrigerator compartment are adjustable.

To remove the shelves:

1. Remove all items from the shelf.
2. Tilt the shelf up at the front.
3. Lift the shelf up at the back and bring the shelf out.

To replace the shelves:

1. While tilting the shelf up, insert the top hook at the back of the shelf in a slot on the track.
2. Lower the front of the shelf until the bottom of the shelf locks into place.

Quick Space Shelf (on some models)

This shelf splits in half and slides under itself for storage of tall items on the shelf below.

This shelf can be removed and replaced or relocated.

NOTE: The back half of the Quick Space Shelf is not adjustable.

Adjustable Door Bins (on some models)

To remove: Lift the bin straight up; then pull out.

To replace: Engage the bin in the molded supports on the door and push down to lock in place.

Non-Adjustable Gallon Door Bins (on some models)

To remove: Lift the bin straight up; then pull out.

To replace: Engage the bin in the molded supports on the door and push down to lock in place.

Pans

Not all features are on all models.

Climate Zone Pans

Keep fruits and vegetables organized in separate compartments for easy access. Excess water that may accumulate in the bottom of the drawers or under the drawers should be wiped dry.

To remove pan:

Slide the pan out to the stop position, lift the pan up and past the stop position and pull forward.

Full-Width Pan (on some models)

To remove pan:

1. Pull the pan out to the stop position.
2. Lift the front of the drawer up and out.

To replace pan:

1. Place back of the drawer in first and rotate drawer front down to seat it on the slides.
2. Push the drawer in to the closed position.

How to Remove and Replace Drawer Divider

To remove:

1. Pull the drawer out to the stop position.
2. Slide pan divider to right to release it from pan.

To replace:

Reverse steps 1 and 2 to replace drawer divider.

Floating Snack Pan (on some models)

This pan can be moved to the most useful location for your family's needs.

To remove, slide the pan out to the stop position, lift the pan up and past the stop position and lift it out.

Freezer Drawer (on some models)

Not all features are on all models.

FREEZER BASKETS

1. An ice bucket in the top basket (on some models).
2. A top full-width basket.
3. A bottom full-width basket (with divider - in some models).

NOTE: Do not fill baskets higher than the rim of the basket. This may cause baskets to stick or jam when opening or closing.

Top Basket Removal

To remove the top full-width basket on freezer drawer models:

1. Pull the basket out to the stop location.
2. Lift basket up to release it from the slides.

When replacing the basket, make sure that the basket remains mounted on the side rails and over the slides of the bottom basket.

NOTE: Always be sure to fully close this basket.

Bottom Basket Removal

To remove the bottom full-width basket on freezer drawer models:

1. Open the bottom freezer drawer until it stops.
2. Remove the top freezer basket.
3. The bottom freezer basket rests on the inside tabs on the drawer slides.
4. Lift the front of the basket and pull forward.
5. Release the pin from the slot to remove the basket.

When replacing the bottom full-width basket, tilt the basket back and lower it into the drawer.

Rotate the basket to a horizontal position and press down. Make sure to place the pin back into the slot.

NOTE: Always be sure that the basket is seated on the bracket tabs before sliding the drawer back into the freezer.

Freezer Compartment

Not all features are on all models.

FREEZER SHELF AND BASKET

1. A full-width fixed wire shelf
2. A full-width sliding plastic basket

NOTE: Do not fill baskets higher than the rim. This may cause basket to stick or jam when opening or closing.

Basket Removal

To remove the full-width sliding basket on freezer door models:

1. Open the basket out to its full extension.
2. Lift up the front of the basket and pull straight out to remove.

When replacing the basket, insert the plastic basket into the lower liner rails and push back into place.

Fixed Shelf Removal

NOTE: The full-width wire shelf is not intended to slide.

To remove for cleaning, push the shelf to one side while then pull up on the opposite side and out to remove.

To replace the full-width wire shelf, insert one side of the shelf into the supports, pushing the shelf to that side until the opposite side will fit into its supports.

Automatic Ice maker

A newly installed refrigerator may take 12 to 24 hours to begin making ice.

Automatic Ice maker (on some models)

The icemaker will produce seven cubes per cycle approximately 100-130 cubes in a 24-hour period, depending on freezer compartment temperature, room temperature, number of door openings and other use conditions.

If the refrigerator is operated before the water connection is made to the icemaker, set the power switch in the OFF position.

When the refrigerator has been connected to the water supply, set the power switch to the ON position.

The icemaker will fill with water when it cools to 15°F (-10°C). A newly installed refrigerator may take 12 to 24 hours to begin making ice cubes.

You may hear a buzzing sound each time the icemaker fills with water.

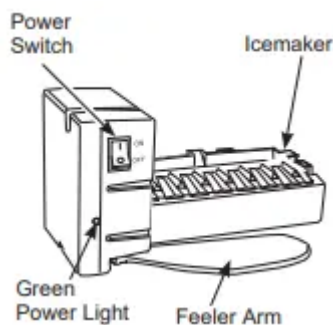

Throw away the first few batches of ice to allow the water line to clear. Be sure nothing interferes with the sweep of the feeler arm.

When the bin fills to the level of the feeler arm, the icemaker will stop producing ice. It is normal for several cubes to be joined together.

If ice is not used frequently, old ice cubes will become cloudy, taste stale and shrink.

CAUTION

To minimize the risk of personal injury, avoid contact with the moving parts of the ejector mechanism, or with the heating element that releases the cubes. Do not place fingers or hands on the automatic ice making mechanism while the refrigerator is plugged in.

For Refrigerator Models with Ice maker in the Door Ice Bucket and Dispenser

- Open the ice box door on inside of the left door.
- Pull up and out on the ice bucket in the left hand door to remove it from the compartment.
- To replace the ice bucket, set it on the guide brackets and push until the ice bucket seats properly.

- If bucket cannot be replaced, rotate the ice bucket fork 1/4 turn clockwise.
- Icemaker can be turned on and off using this display (see Controls.)

For Refrigerator Models with Icemaker in the Freezer Compartment

Some models come with an icemaker installed in the freezer compartment. For those models that come ice-maker ready, you can purchase Kit IM4D. Visit our website or call GE Appliances Parts and Accessories, 877.959.8688

There is ice storage in the freezer compartment located on the left side of the upper basket. Pull the upper basket forward to remove the ice bucket.

Care and Cleaning

Cleaning the Outside

FINGERPRINT RESISTANT STAINLESS STEEL*, BLACK STAINLESS, SLATE, DARK SLATE, PAINTED - Outside surfaces, door handles, and trim

DO NOT use Stainless Steel cleaners on the door surfaces.

IMPORTANT: The use of incorrect products may damage the outer finish of Fingerprint Resistant Stainless and Black Stainless models. Please follow these instructions and use only the appropriate items below to clean your appliance surfaces.

- Clean interior/exterior surfaces with warm water, mild soap or detergent, and a soft or microfiber cloth to avoid damage.
- Wipe the appliance surface dry with a soft clean cloth or microfiber towel to avoid streaking or water spotting.

* Easily wipe away smudges and fingerprints.

STAINLESS STEEL - Outside surfaces, door handles, and trim

NOTE: DO NOT allow stainless steel cleaner to come in contact with any plastic parts such as trim pieces, handle hardware and liners. If unintentional contact of cleaners with plastic parts does occur, clean plastic part with a sponge and mild detergent mixed with warm water.

Cleaning the Inside

Unplug the refrigerator before cleaning.

If this is not practical, wring excess moisture out of sponge or cloth when cleaning controls. switches, lights or

Use an appliance wax polish on the inside surface between the doors.

Use warm water and baking soda solution-about a tablespoon (15 ml) of baking soda to a quart (1 liter) of water. This both cleans and neutralizes odors. Rinse and wipe dry.

CAUTION

Do not clean glass shelves or covers with warm water when they are cold. Glass shelves and covers may break if exposed to sudden temperature changes or impact such as bumping or dropping.

Tempered glass is designed to shatter into many small pieces if it breaks.

Behind the Refrigerator

Be careful when moving the refrigerator away from the wall. All types of floor coverings can be damaged, particularly cushioned coverings and those with embossed surfaces.

Raise the leveling legs located at the bottom front of the refrigerator.

Pull the refrigerator straight out and return it to position by pushing it straight in. Moving the refrigerator in a side direction may result in damage to the floor covering or refrigerator.

Lower the leveling legs until they touch the floor.

When pushing the refrigerator back, make sure you don't roll over the power cord or water supply line.

Preparing for Vacation

For long vacations or absences, remove food and unplug the refrigerator. Clean the interior with a baking soda solution of one tablespoon (15 ml) of baking soda to one quart (1 liter) of water. Leave the doors open.

If the temperature can drop below freezing, have a qualified service technician drain the water supply system to prevent serious property damage due to flooding.

- 1) Turn refrigerator off (pages 7 and 8 or unplug the refrigerator).
- 2) Empty ice bucket
- 3) Turn water supply off

If you cut the water supply off, turn off the icemaker

Upon returning from vacation:

- 1) Replace the water filter.
- 2) Run 2 gallons of water through the cold water dispenser (about 5 minutes) to flush the system.

Preparing to Move

Secure all loose items such as shelves and drawers by taping them securely in place to prevent damage.

When using a hand truck to move the refrigerator, do not rest the front or back of the refrigerator against the hand truck. This could damage the refrigerator.

Handle only from the sides of the refrigerator.

Be sure the refrigerator stays in an upright position during moving.

Replacing the Lights

There is LED lighting in the fresh food compartment at the top center and on the left and right sides above the climate zone pans on the french door models. LED lighting is located at the top of the fresh food compartment on the single door models.

LED lights are also located at the top of the left and right sides of the freezer in all models.

An authorized technician will need to replace the LED light.

If this assembly needs to be replaced, call GE Appliances Service at 1.800.432.2737 in the United States or 1.800.561.3344 in Canada.

Installation Instruction

Refrigerator

TOOLS YOU MAY NEED

APPLIANCE DIMENSIONS

MEASURE THE CABINET OPENING ACCORDING TO THE WIDTH OF THE REFRIGERATOR

Measure width of cabinet opening where refrigerator will be placed, B

Be sure to account for any countertop overhang, baseboard thickness and any clearance desired. Width, B, should not be less than 30"-36" (76.2 cm - 91.4 cm) (depending on model). The refrigerator will be placed approximately in the middle of this opening.

INSTALLING THE REFRIGERATOR

REFRIGERATOR LOCATION

- Do not install the refrigerator where the temperature will go below 60°F (16°C) because it will not run often enough to maintain proper temperatures.
- Do not install the refrigerator where the temperature will go above 100°F (37°C) because it will not perform properly.
- Do not install the refrigerator in a location exposed to water (rain, etc.) or direct sunlight.

CLEARANCES

Allow the following clearances for ease of installation, proper air circulation and plumbing and electrical connections.

Install it on a floor strong enough to support it fully loaded.

Sides 1/8" (3 mm)

Top 1" (25 mm) Cabinet/Hinge Cover

Back 2" (50 mm)

IMPORTANT NOTES

This refrigerator without the handles ranges from 34 to 35-1/4" (86.4 cm - 89.5 cm) depending on your model (see dimension G on the previous page). Doors and passageways leading to the installation location must be at least 36" (91.4 cm) in order to leave the doors attached to the refrigerator while transporting it into the installation location. If passageways are less than 36" (91.4 cm), the refrigerator doors can easily be scratched and damaged. The doors can be removed to allow the refrigerator to be safely moved indoors.

- If you need to remove the door and you have the french door model, see Removing French Doors.
- If you need to remove the door and you have the single fresh food door model, see Reversing the Door.
- To remove the freezer door and you have the model with a freezer drawer see Removing Freezer Drawer.
- If you have the model with the hinged freezer door see Reversing the Door.
- If it is NOT necessary to remove doors, skip. Leave tape and all packaging on doors until the refrigerator is in the final location. Once in place, install door handles (see Steps 1 and 2).
- SKID REMOVAL: Tilt refrigerator to each side to remove skid
- NOTE: Use a padded hand truck to move this refrigerator. Place the refrigerator on the hand truck with a side against the truck. We strongly recommend that TWO PEOPLE move and complete this installation.

1 ATTACH REFRIGERATOR HANDLES

Attach refrigerator handle to the mounting fasteners by aligning the slots on the handle with the mounting fasteners. Slide the handle down until it comes to a hard stop.

NOTE: For French Door models, follow the same procedure for both doors. Verify handle is securely attached upwards.

2 ATTACH FREEZER HANDLE

Attach the handle to the mounting fasteners by aligning the slots on the handle with the mounting fasteners. Slide the handle to the right until you hear 'click'

REMOVING FRENCH DOORS (on some models)

WARNING

Follow all steps when reversing the door swing. Failure to follow these instructions, leaving off parts, or overtightening screws, can lead to the door falling off and result in injury and property damage.

IMPORTANT NOTES

When removing french doors:

- Read the instructions all the way through before starting.
- Handles are included inside the refrigerator.
- Place the screws by their related parts to avoid using them in the wrong places.
- Provide a non-scratching work surface for the doors.

CAUTION Lifting Hazard.

Single person lift can cause injury. Use assistance when handling, moving or lifting the refrigerator doors.

NOTE: When moving door, to prevent damage to door and electronics carefully place the door in a proper location.

WARNING

To eliminate the risk of electric shock or injury during installation, you must first unplug the refrigerator before proceeding. Failure to follow these instructions can result in electrical shock.

Tape the doors shut with adhesive tape.

1 REMOVING RIGHT DOOR

A. Remove the hinge cover on top of the right fresh food door by removing the screw using a Phillips screwdriver.

B Using a 5/16" socket ratchet/driver, remove the bolts securing the top hinge to the cabinet. Lift the hinge support straight up to free the hinge pin from the socket in the top of the door.

C. Remove the tape from the right door and tilt the door away from the cabinet. Lift the door off the center hinge pin.

D. Set the door on a non-scratching surface with the inside up.

2 REMOVING LEFT DOOR

A. For Ice and Water Models Only: Unplug the water line from the back of the refrigerator and remove all tape that fixes the water line to the refrigerator.

B. Remove the hinge cover on top of the left fresh food door by removing the screw using a Phillips screwdriver.

C. Unplug the 3 wire connectors and move the wires until you can see the screws holding the hinge.

For Ice and Water Models Only: Pull the water line very carefully.

D. Using a 5/16" socket/ratchet driver, remove the bolts securing the top hinge to the cabinet.

For NON Ice and Water Models Only: Lift the hinge straight up to free the hinge pin from the socket in the top of the door and pass the wire through the slot in the hinge. For Ice and Water Models Only: Do not remove hinge from the door.

E. Remove the tape from the door, open the door 90 degrees and tilt the door away from the cabinet. Lift the door off the center hinge pin.

F. Set the door on a non-scratching surface with the inside up.

3 REMOVING CENTER HINGES AND BRACKETS

A. Using a 1/4" Allen wrench, remove the 2 hinge pins from the hinge brackets.

B. Using a 5/16" socket/ratchet driver, remove the bolts securing the center hinge brackets to the cabinet.

REINSTALLING FRENCH DOORS (on some models)

1 REINSTALLING CENTER HINGE BRACKETS AND HINGES

A. Using a 5/16" socket/ratchet driver, reinstall the bolts and center hinge brackets to the cabinet.

B. Using a 1/4" Allen wrench, reinstall the 2 hinge pins into the hinge brackets.

2 REHANGING THE RIGHT DOOR

A. Lower the refrigerator door onto the right hinge pin.

B. Make sure the door is aligned with the cabinet. Attach the hinge to the top of the cabinet loosely with bolts removed earlier.

C. Make sure the gasket on the door is flush against the cabinet and is not folded. Tighten the bolts to 60 lb/in.(6.78 Nm).

D. Replace the right hinge cover on top of the refrigerator using a Phillips screwdriver.

3 REHANGING THE LEFT DOOR

A. For NON Ice and Water Models Only: Pass the wire through the slot in the hinge. Place the hinge pin into the top of the door.

B. Lower the refrigerator door onto the left hinge pin.

C. Make sure the door is aligned with the cabinet. Attach the hinge to the top of the cabinet loosely with bolts removed earlier.

D. Make sure the gasket on the door is flush against the cabinet and is not folded. Tighten the bolts to 60 lb/in. (6.78 Nm).

E. Plug the wire connectors together and rout the wire inside the plastic port.

F. For Ice and Water Models Only: Put the water line into the hole and pass through the plastic port to the back of the refrigerator. Plug the water line back into the fixture on back of the refrigerator. Tape water line to the refrigerator.

G. Replace the left hinge cover on top of the refrigerator using a Phillips screwdriver.

REMOVING FREEZER DRAWER (on some models)

IMPORTANT NOTES

When removing freezer drawer:

- Read the instructions all the way through before starting.
- Provide a non-scratching work surface for the doors.

1 REMOVE THE BASKETS

A. Open the freezer drawer until it stops.

B. Pull the top basket out until it stops. Lift the basket up on the front and out to remove.

C. The lower basket rests on a frame inside the freezer drawer. Lift the front of the basket and pull it forward. Release the pins from the slots on the frame to remove the basket.

2 REMOVE THE DRAWER FRONT

A. Remove the screw on each side of the railing.

B. Lift up on both sides of the freezer drawer handle to separate the drawer railings from the rail assemblies.

C. Set the drawer front on a non-scratching surface.

D. Push the rail assemblies back into locking position.

3 REINSTALL FREEZER DRAWER FRONT

A. Pull the rail assemblies to the maximum extension.

B. Locate the slots on the inside of each slide.

C. Insert the hooks on the ends of the drawer assembly extensions into the slots near the back of the slides.

D. Lower the front end of the freezer drawer assembly so the side tabs fit into the front slots on the rail assemblies.

E. Replace the safety screws in both sides of the slide assemblies.

F. Replace lower and upper baskets (see About freezer drawer).

REVERSING THE DOOR (on some models)

WARNING Follow all steps when reversing the door swing. Failure to follow these instructions, leaving off parts, or overtightening screws, can lead to the door falling off and result in injury and property damage.

IMPORTANT NOTES

When reversing doors:

- Read the instructions all the way through before starting.
- Logo badge, handles, plugs and right hinge cover are included inside the refrigerator (some models).
- Place the screws by their related parts to avoid using them in the wrong places.
- Provide a non-scratching work surface for the doors.

CAUTION Lifting Hazard.

Single person lift can cause injury. Use assistance when handling, moving or lifting the refrigerator doors.

NOTE: When removing door, to prevent damage to door and electronics carefully place the door in a proper location.

NOTE: The lower door hinge pin and hinge are keyed and must be matched correctly for the door to self close properly. Please follow directions carefully.

Freezer door is heavy. Use both hands to secure the door before lifting.

WARNING

To eliminate the risk of electric shock or injury during installation, you must first unplug the refrigerator before proceeding. Failure to follow these instructions can result in electrical shock.

1 REMOVE THE REFRIGERATOR DOORS

A. Tape the door shut with masking tape.

B. Remove right and left hinge covers on top of the refrigerator using a Phillips screwdriver.

C. Using a 5/16" socket/ ratchet driver, remove the bolts securing the top hinge to the cabinet. Lift the hinge straight up to remove.

D. Remove the tape and tilt the fresh food door away from the cabinet. Lift the door off of the center hinge pin.

E. Set the fresh food door on a non-scratching surface with the inside up.

For Models With a Freezer DRAWER:

F. Using a 1/4" Allen wrench, remove the hinge pin from the hinge bracket. The hinge pin will be used again on the opposite side.

G. Using a 5/16" socket/ratchet driver, remove the bolts securing the center hinge to the cabinet.

H. Remove the button plugs on the left side of the cabinet across from where the hinge bracket was located and install in the holes where the bracket was removed.

I. Flip the center hinge bracket and install on the left side of the cabinet where the button plugs were removed.

J. Using a 1/4" Allen wrench, install the hinge pin into the center hinge bracket.

For Models With a Freezer DOOR:

F. Tape the freezer door shut with adhesive tape.

G. Using a 1/4" Allen wrench, remove the hinge pin from the hinge bracket. The hinge pin will be used again on the opposite side.

H. Remove the tape and tilt the door away from the cabinet. Lift the door off of the bottom hinge pin.

I. Using a thin-blade screwdriver remove the button plug from the top left side of the door and install it on the opposite side.

J. Set the door on a non-scratching surface with the inside up.

K. Using a 5/16" socket/ ratchet driver, remove the bolts securing the center hinge to the cabinet.

L. Locate the button plugs in the kit and install them in the opposite side of center hinge.

M. Flip the center hinge bracket. Using a 5/16" socket/ratchet driver, install the center hinge bolt on the left side of the cabinet and torque to 60 in-lb. (6.78 Nm).

N. Using a 1/4" Allen wrench, install the hinge pin into the center hinge bracket. Do not let the pin go past the bottom of the bracket.

O. Using a 5/16" socket/ ratchet driver, remove the screws from the bottom hinge bracket. These will be reinstalled on the other side. Pull up on the hinge pin to remove.

P. Using a Torx T-20 screwdriver, remove the screw from the cabinet and install it on the other side.

Q. Using 5/16" socket/ ratchet driver, install the bottom hinge bracket and torque the screws to 60 in-lb. (6.78 Nm). Remount the hinge and pin in the opposite hole on the cabinet.

2 REINSTALL FREEZER DOOR

A. Using a Torx T-20 screwdriver, remove the bolts securing the door stop on the bottom right of the door.

B. Using a Trox T-20 screwdriver, remove the plastic force closure on the bottom right of the door.

C. Flip the plastic force closure and mount it to the bottom left of the door.

D. Install the door stop to the bottom left of the door.

E. Lower the freezer door and make sure to insert the hinge pin in the bottom hole of the door.

F. Straighten the door and line it up with the center hinge bracket. Using a 1/4" Allen wrench, turn the hinge pin until it extends through the hinge bracket and into the door.

3 REINSTALL FRESH FOOD DOOR

A. Using a Torx T-20 screwdriver, remove the bolts securing the door stop on the bottom right of the door.



- B. Transfer the plastic thimble to the opposite hole. Install the door stop with the plastic thimble on the opposite side.
- C. Using a Trox T-20 screwdriver, remove the plastic force closure on the bottom right of the door.
- D. Flip the plastic force closure and mount it to the bottom left of the door.
- E. Install the door stop to the bottom left of the door.
- F. Lower the fresh food door and make sure to insert the hinge pin in the bottom hole of the door.
- G. Remove the hinge base from the hinge. Flip the hinge over and remount to hinge base.
- H. Insert the top hinge pin inside the hole in the top left of the fresh food door. Make sure the door is aligned with the cabinet. Attach the hinge to the top of the cabinet loosely with the bolts that were removed previously. Make sure the gasket on the door is flush against the cabinet and not folded. Support the door on the handle side and make sure the door is straight and the gap between the doors is even across the front. While holding the door in place, tighten the screws to 60 in-lb. (6.78 Nm).

For Models with a Freezer DRAWER:

- I. Remove the front insert from the left hinge cover. Install the left hinge cover using a Phillips screwdriver and the screw removed earlier.
- J. Install the front insert into the right hinge cover. Install the right hinge cover using a Phillips screwdriver and the screws removed earlier.

For Models with a Freezer DOOR:

- I. Locate the left hinge cover that comes with the kit. Using a Phillips screwdriver, install the cover with the screws provided.
- J. Locate the insert for the right hinge cover that comes with the kit and install.
- K. Using a Phillips screwdriver, install the right hinge cover with screws provided.

4 TRANSFER HANDLE & MOUNTING FASTENERS

- A. Remove the plug from the lower right whole.
- B. Using a Phillips screwdriver remove the screws holding the mounting brackets from the left side and install them on the right side.

5 INSTALLING LOGO BADGE

- A. Locate the new logo badge from the kit. Remove the adhesive backing paper and align the pins on the back of the badge with the holes in the door. Apply pressure to the badge to ensure it sticks to the door.
- B. Locate the button plug from the kit and install it in the opposite side of handle.

CONNECTING TO THE HOUSE WATER LINE (icemaker models only)



A cold water supply is required for automatic icemaker operation. If there is not a cold water supply, you will need to provide one. See Installing the Water Line section.

NOTES:

- Before making the connection to the refrigerator, be sure the refrigerator power cord is not plugged into the wall outlet.
- If your refrigerator does not have a water filter, we recommend installing one if your water supply has sand or particles that could clog the screen of the refrigerator's water valve. Install it in the water line near the refrigerator. If using SmartConnect™ Refrigerator Tubing Kit, you will need an additional tube (WX08X10002) to connect the filter. Do not cut plastic tube to install filter.
- Before connecting the water line to the house, purge the house line for at least 2 minutes.

A. If you are using copper tubing, place a compression nut and ferrule (sleeve) onto the end of the tubing coming from the house cold water supply.

If you are using the SmartConnect™ tubing, the nuts are already assembled to the tubing.

B. If you are using copper tubing, insert the end of the tubing into the refrigerator connection, at the back of the refrigerator, as far as possible. While holding the tubing, tighten the fitting.

If you are using SmartConnect™ tubing, insert the molded end of the tubing into the refrigerator connection, at the back of the refrigerator, and tighten the compression nut until it is hand tight.

Then tighten one additional turn with a wrench. Over tightening may cause leaks.

C. Fasten the tubing into the clamp provided to hold it in position. You may need to pry open the clamp.

One of the illustrations below will look like the connection on your refrigerator.

Icemaker-Ready Models

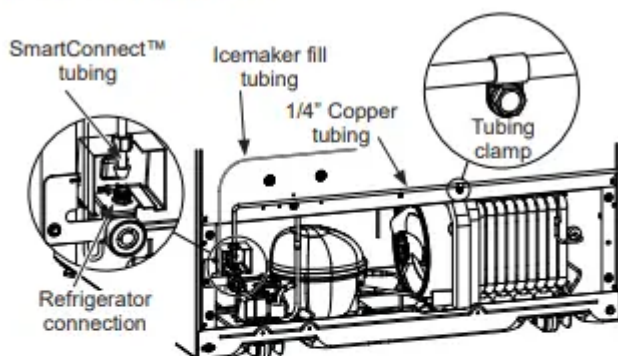

Icemaker-Installed Models

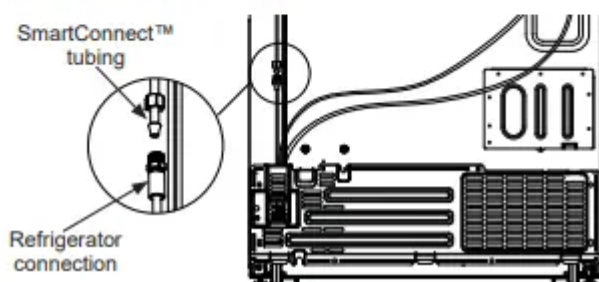

TURN ON THE WATER SUPPLY(Icemaker models only)

Turn the water on at the shutoff valve (house water supply) and check for any leaks.

PLUG IN THE REFRIGERATOR

On models with an icemaker, before plugging in the refrigerator, make sure the icemaker power switch is set to the 0 (off) position.

PUT THE REFRIGERATOR IN PLACE

Move the refrigerator to its final location.

LEVEL THE REFRIGERATOR

Adjustable legs at the front corners of the refrigerator should be set so the refrigerator is firmly positioned on the floor, and the front is raised just enough that the door closes easily when opened about halfway.

To adjust the leveling legs, turn the legs clockwise to raise the refrigerator, counterclockwise to lower it.

LEVEL THE REFRIGERATOR DOORS (on some models)

Remember a level refrigerator is necessary for getting the doors perfectly even. If you need help, review the previous section on leveling the refrigerator.

If the doors remain uneven, turn the adjustable pin to raise the lowest door using a 1/4" allen wrench to turn the pin.

INSTALLING THE WATER LINE

WHAT YOU WILL NEED

- Copper or SmartConnect™ Refrigerator Tubing kit, 1/4" outer diameter to connect the refrigerator to the water supply. If using copper, be sure both ends of the tubing are cut square.

To determine how much tubing you need: measure the distance from the water valve on the back of the refrigerator to the water supply pipe. Be sure there is sufficient extra tubing to allow the refrigerator to move out from the wall after installation.

SmartConnect™ Refrigerator Tubing Kits are available in the following lengths:

6' (1.8 m) - WX08X10006

15' (4.6 m) - WX08X10015

25' (7.6 m)- - WX08X10025

WARNING

Connect to potable water supply only.

A cold water supply is required for automatic icemaker operation. The water pressure must be between 40 and 120 psi (275-827 kilopascals)

NOTE: The only GE Appliances approved plastic tubing is that supplied in SmartConnect™ Refrigerator Tubing kits. Do not use any other plastic water supply line because the line is under pressure at all times. Certain types of plastic will crack or rupture with age and cause water damage to your home.

- A GE Appliances water supply kit (containing tubing, shutoff valve and fittings listed below) is available at extra cost from your dealer or from
- Parts and Accessories, 877.959.8688 (in Canada 1.800.661.1616).
- A cold water supply. The water pressure must be between 20 and 120 p.s.i. (138-827 kPa).
- Power drill.
- 1/2" or adjustable wrench.
- Straight and Phillips blade screwdriver.
- Two 1/4" outer diameter compression nuts and 2 ferrules (sleeves) to connect the copper tubing to the shutoff valve and the refrigerator water valve.
- If you are using a SmartConnect™ Refrigerator Tubing kit, the necessary fittings are preassembled to the tubing.
- If your existing copper water line has a flared fitting at the end, you will need an adapter (available at plumbing supply stores) to connect the water line to the refrigerator OR you

can cut off the flared fitting with a tube cutter and then use a compression fitting. Do not cut formed end from SmartConnect™ Refrigerator tubing

- Shutoff valve to connect to the cold water line. The shutoff valve should have a water inlet with a minimum inside diameter of 5/32" at the point of connection to the COLD WATER LINE. Saddle-type shutoff valves are included in many water supply kits. Before purchasing, make sure a saddle-type valve complies with your local plumbing codes.

Install the shutoff valve on the nearest frequently used drinking water line.

1 SHUT OFF THE MAIN WATER SUPPLY

Turn on the nearest faucet long enough to clear the line of water.

2 CHOOSE THE VALVE LOCATION

Choose a location for the valve that is easily accessible. It is best to connect into the side of a vertical water pipe. When it is necessary to connect into a horizontal water pipe, make the connection to the top or side, rather than at the bottom, to avoid drawing off any sediment from the water pipe.

3 DRILL THE HOLE FOR THE VALVE

Drill a 1/4" hole in the water pipe (even if using a self-piercing valve), using a sharp bit. Remove any burrs resulting from drilling the hole in the pipe.

Take care not to allow water to drain into the drill.

Failure to drill a 1/4" hole may result in reduced ice production or smaller cubes.

4 FASTEN THE SHUTOFF VALVE

Fasten the shutoff valve to the cold water pipe with the pipe clamp.

NOTE: Commonwealth of Massachusetts Plumbing Codes 248CMR shall be adhered to. Saddle valves are illegal and use is not permitted in Massachusetts. Consult with your licensed plumber.

5 TIGHTEN THE PIPE CLAMP

Tighten the clamp screws until the sealing washer begins to swell.

NOTE: Do not over tighten or you may crush the tubing.

6 ROUTE THE TUBING

Route the tubing between the cold water line and the refrigerator.

Route the tubing through a hole drilled in the wall or floor (behind the refrigerator or adjacent base cabinet) as close to the wall as possible.

7 FASTEN THE SHUTOFF VALVE

Place the compression nut and ferrule (sleeve) for copper tubing onto the end of the tubing and connect it to the shutoff valve.

Make sure the tubing is fully inserted into the valve. Tighten the compression nut securely.

For plastic tubing from a SmartConnect™ Refrigerator Tubing kit, insert the molded end of the tubing into the shutoff valve and tighten compression nut until it is hand tight, then tighten one additional turn with a wrench. Over tightening may cause leaks.

NOTE: Commonwealth of Massachusetts Plumbing Codes 248CMR shall be adhered to. Saddle valves are illegal and use is not permitted in Massachusetts. Consult with your licensed plumber.

8 FLUSH OUT THE TUBING

Turn the main water supply on and flush out the tubing until the water is clear.

Shut the water off at the water valve after about one quart (1 liter), or 2 minutes, of water has been flushed through the tubing.

To complete the installation of the refrigerator, go back to Step 11 in Installing the Refrigerator.

TROUBLESHOOTING TIPS

Normal Operating Conditions.

Newer refrigerators sound different from older refrigerators

Modern refrigerators have more features and use newer technology

Do you hear what I hear? These conditions are normal.

- The new high efficiency compressor may run faster and longer than your old refrigerator and you may hear a high-pitched hum or pulsating sound while it is operating.
- You may hear a whooshing sound when the doors close. This is due to pressure equalizing within the refrigerator.

CLICKS, POPS, CRACKS and SNAPS

- You may hear cracking or popping sounds when the refrigerator is first plugged in. This happens as the refrigerator cools to the correct temperature.
- Expansion and contraction of cooling coils during and after defrost can cause a cracking or popping sound.
- On models with an icemaker, after an ice making cycle, you may hear the ice cubes dropping into the ice bucket.
- On models with a dispenser, during water dispense, weder you may hear the water lines move at initial dispense and after dispenser button is released.
- You may hear the fans spinning at high speeds. This happens when the refrigerator is first plugged in, when the doors are opened frequently or when a large amount of food is added to the refrigerator or freezer compartments. The fans are helping to maintain the correct temperatures.

- The fans change speeds in order to provide optimal cooling and energy savings.

WATER SOUNDS

- The flow of refrigerant through the cooling coils may make a gurgling noise like boiling water.
- Water dropping on the defrost heater can cause a sizzling, popping or buzzing sound during the defrost cycle.
- A water dripping noise may occur during the defrost cycle as ice melts from the evaporator and flows into the drain pan.
- Closing the door may cause a gurgling sound due to pressure equalization.

Before you call for service

Refrigerator does not operate

- Refrigerator in defrost cycle.
 - Wait about 30 minutes for defrost cycle to end.
- Either or both controls set to OFF.
 - Set the controls to a lower temperature setting.
- Refrigerator is unplugged.
 - Push the plug completely into the outlet.
- The fuse is blown/circuit breaker is tripped.
 - Replace fuse or reset the breaker.
- Refrigerator is in showroom mode.
 - Unplug the refrigerator and plug it back in.

Vibration or rattling (slight vibration is Leveling legs need adjusting. normal)

- Leveling legs need adjusting.
 - See Level the refrigerator.

Motor operates for long periods or cycles on and off frequently.(Modern refrigerators with more storage space and a larger freezer require more operating time. They start and stop often to maintain even temperatures.)

- Normal when refrigerator is first plugged Wait 24 hours for the refrigerator to completely cool down
 - Wait 24 hours for the refrigerator to completely cool down.
- Often occurs when large amounts of food are placed in refrigerator.
 - This is normal.

- Door left open.
 - Check to see if package is holding door open.
- Hot weather or frequent door openings.
 - This is normal.
- Temperature controls set at the coldest setting.
 - See Controls section

Refrigerator or freezer compartment too warm

- Temperature control not set cold enough.
 - See Controls section
- Warm weather or frequent door openings.
 - Set the temperature control one step colder. See Controls section
- Door left open.
 - Check to see if package is holding door open.

Frost or ice crystals on frozen food(frost within package is normal)

- Door left open.
 - Check to see if package is holding door open.
- Too frequent or too long door openings.
 - This is normal.

Divider between refrigerator and freezer compartments feels warm

- Automatic energy saver system circulates warm liquid around front edge of freezer compartment.
 - This helps prevent condensation on the outside.

Automatic icemaker does not work

- Icemaker power switch is in the OFF position.
 - Set the power switch to the ON position.
- See Installing the Water Line section
 - Water supply turned off or not connected.
- Freezer compartment too warm.
 - Wait 24 hours for the refrigerator to completely cool down.
- Piled up cubes in the storage bin cause the icemaker to shut off.
 - Level cubes by hand.

- Ice cubes stuck in icemaker.
 - Turn off the icemaker, remove cubes, and turn the icemaker back on.

Freezer cooling, fresh food not cooling

- Normal, when refrigerator first plugged in or after extended power outage
 - Wait 24 hours for temperature in both compartments to reach selected temperatures.

Ice dispenser opens after closing freezer drawer (on some models)

- Normal
 - The ice dispenser door may open after closing freezer door to allow access.

Ice cubes have odor/taste

- Ice storage bin needs cleaning.
 - Empty and wash bin. Discard old cubes.
- Food transmitting odor/taste to ice cubes.
 - Wrap foods well.
- Interior of refrigerator needs cleaning.
 - See Care and Cleaning section.

Small or hollow cubes

- Water filter clogged
 - See Care and Cleaning section

Slow ice cube freezing

- Door left open.
 - Check to see if package is holding door open
- Temperature control not set cold enough.
 - See Controls section

Frequent "buzzing sound"

- Icemaker power switch is in the 1 (on) position, but the water supply to the refrigerator has not been connected.
 - Set the power switch to the 0 (off) position. Keeping it in the 1 (on) position will damage the water valve.

Orange glow in the freezer

- Defrost heater is on.
 - This is normal.

Water has poor taste/odor

- Water dispenser has not been used for a long time.
 - Dispense water until all water in system is replenished.

Water in first glass is warm

- Normal when refrigerator is first installed.
 - Wait 24 hours for the refrigerator to completely cool down.
- Water dispenser has not been used for a long time.
 - Dispense water until all water in system is replenished.
- Water system has been drained
 - Allow several hours for replenished supply to chill.

Water dispenser does not work

- Water supply line turned off or not connected.
 - See Installing the water line section
- Water filter clogged.
 - Replace filter cartridge or remove filter and install plug
- Air may be trapped in the water system.
 - Press the dispenser arm for at least two minutes.
- Dispenser is LOCKED
 - Press and hold the LOCK pad for 3 seconds.

Water spurting from dispenser

- Newly-installed filter cartridge.
 - Run water from the dispenser for 3 minutes about one and a half gallons).

Water is not dispensed but icemaker is working

- Water in reservoir is frozen.
 - Call for service
- Refrigerator control setting is too cold.
 - Set to a warmer setting.

No water or ice cube production

- Supply line or shutoff valve is clogged
 - Call a plumber.
- Water filter clogged
 - Replace filter cartridge or remove filter and install plug

Refrigerator has odor

- Foods transmitting odor to refrigerator.
 - Foods with strong odors should be tightly wrapped. Keep an open box of baking soda in the refrigerator, replace every three months.
- Interior needs cleaning
 - See Care and Cleaning section

Moisture forms on outside of refrigerator

- Not unusual during periods of high humidity.
 - Wipe surface dry

Moisture collects inside (in humid weather, air carries moisture into refrigerator when doors are opened)

- Too frequent or too long door openings
 - This is normal.
- Due to the higher humidity in the refrigerator, you may on occasion experience fog or small amounts of moisture in the refrigerator compartment.
 - This is normal and may come and go as different food loads and environmental conditions change. Wipe dry with a paper towel if desired.

Interior light does not work

- No power at outlet
 - Replace fuse or reset the breaker.
- LED lights are out
 - Call Service-see Replacing the Lights

Hot air from bottom of refrigerator

- Normal air flow cooling motor refrigeration process, it is normal that heat be expelled in the area under the refrigerator. Some floor coverings are sensitive and will discolor at these normal and safe temperatures.
 - This is normal.

Refrigerator never shuts off but the temperatures are OK

- Adaptive defrost keeps compressor running during door openings.
 - This is normal. The refrigerator will cycle off after the door remains closed for 2 hours.

Refrigerator is beeping

- Door is open.
 - Close door.

Door not closing properly

- Door gasket on hinge side sticking or folding over.
 - Apply paraffin wax to the face of the gasket.

Actual temperature not equal to Set temperature

- Unit just plugged in.
 - Allow 24 hours for system to stabilize.
- Door open for too long.
 - Allow 24 hours for system to stabilize.
- Warm food added to refrigerator.
 - Allow 24 hours for system to stabilize.
- Defrost cycle is in process.
 - Allow 24 hours for system to stabilize.

Door/drawer does not close by itself

- Leveling legs need adjusting.
 - See level the refrigerator

Freezer door/drawer pops open when refrigerator door is closed

- This is normal if, after popping open, the freezer door/drawer closed on its own.
 - This indicates that there is a good seal on the freezer door/ drawer. If the freezer door/drawer does not automatically close after popping open, then see the Problem: Door/ drawer does not close by itself, above.

Food freezing in the refrigerator

- Food too close to the air vent at the back of the refrigerator.
 - Move the food away from the air vent.

- Refrigerator control is set too cold.
 - Move the refrigerator control to a warmer temperature setting one increment at a time.

Water is leaking from dispenser

- Glass not being held under the dispenser long enough after button is released.
 - Hold the glass underneath the dispenser for 2-3 seconds after releasing the dispenser button. Water may continue to dispense after the button is released
- Air may be present in the water line system, causing water to drip after being dispensed.
 - Dispense water for at least 2 minutes to remove air from system.

My display is showing tc

- Turbo Cool function is activated.
 - See Controls section

Water filter indicator light changed color

- This is normal.
 - See Water Filter Cartridge - MWF or XWF section

Water filter indicator light remains red even after replacing the water filter

- Water filter indicator must be reset.
 - Press and hold the WATER FILTER pad for 3 seconds. See Water Filter Cartridge - MWF or XWF section.

Water filter indicator light is not lit

- This is normal. The filter cartridge should be replaced when the replacement indicator light turns red.
 - See Water Filter Cartridge - MWF or XWF section

Handle is loose / handle has a gap

- Handle needs adjusting.
 - See Attach the Fresh Food Handle and Attach the Freezer Handle sections

Refrigerator doors are not even(on French Door models only)

- Door need realigning
 - See Level the Refrigerator Doors section

Baskets stick or jam when opening or closing

- Baskets are too full.
 - To open: remove some of the products from the basket when opened as far as possible. Readjust the products left in the basket and try to open the basket again. **To close:** readjust products in the basket or remove any product that is above the rim of the basket and close the basket.

Warning

This content is compiled from multiple sources and is provided for reference purposes only. It may not be complete or fully applicable to all situations. If you are unable to resolve your issue, please contact the product manufacturer or an authorized service provider for official support.