

## SETTINGUP YOUR OVEN

### NAMES OF OVEN PARTS AND ACCESSORIES

Remove the oven and all materials from the carton and oven cavity. Your oven comes with the following accessories:

Glass tray 1

Turntable ring 1

Insrtuction Manual 1

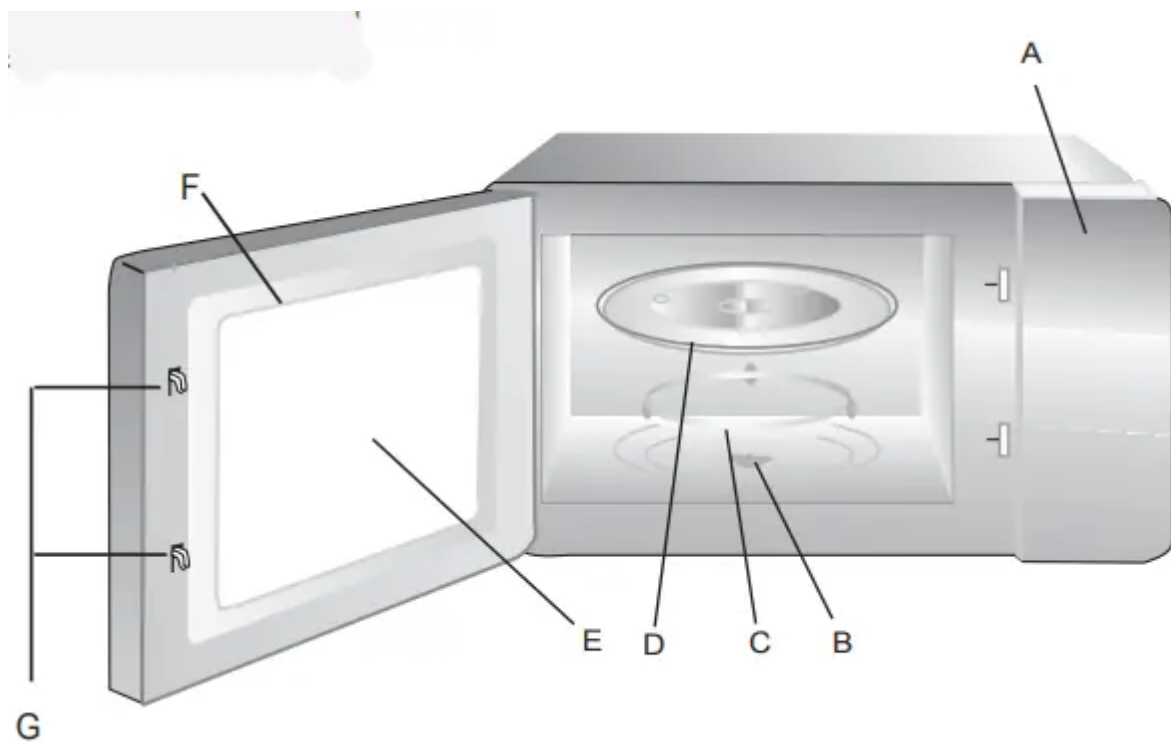

A Control panel

B Turntable shaft

C Turntable ring

D Glass tray

E Observation window

F Oven Door

G Safety interlock system

## TURNTABLE INSTALLATION



- a. Never place the glass tray upside down. The glass tray should never be restricted.
- b. Both glass tray and turntable ring must always be used during cooking.
- c. All food and containers of food are always placed on the glass tray for cooking.

## COUNTERTOP INSTALLATION

Remove all packing material and accessories. Examine the oven for any damage such as dents or broken door. Do not install if oven is damaged.

Cabinet: Remove any protective film found on the microwave oven cabinet surface. Do not remove the light brown Mica cover that is attached to the oven cavity to protect the magnetron.

## INSTALLATION

1. Select a level surface that provide enough open space for the intake and/or outlet vents.

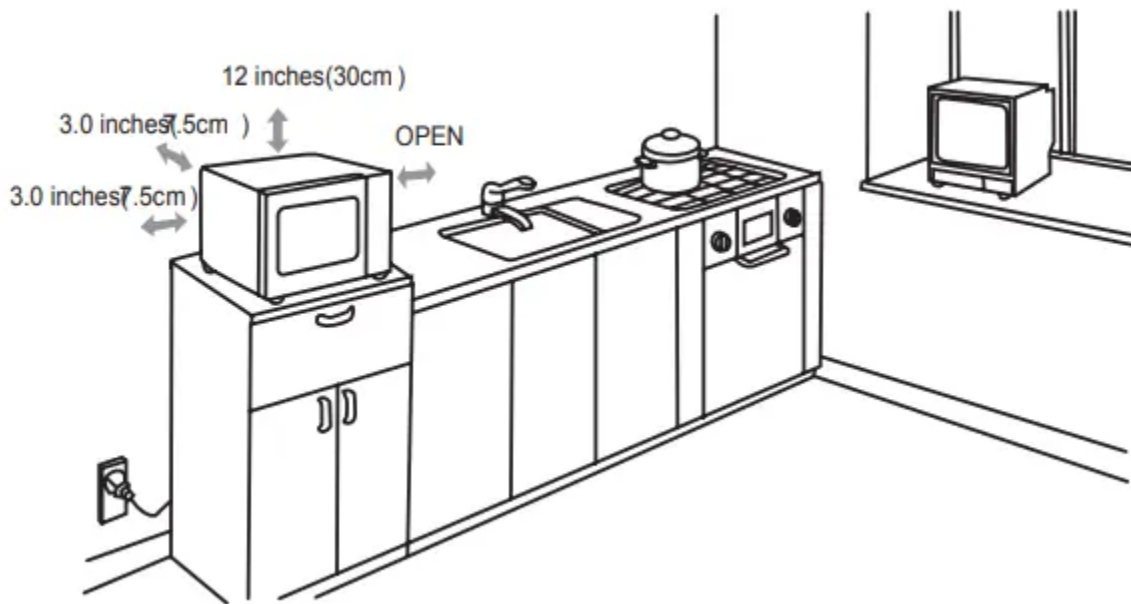

A minimum clearance of 3.0 inches (7.5cm) is required between the oven and any adjacent walls. One side must be open.

1. Leave a minimum clearance of 12 inches (30cm) above the oven.
2. Do not remove the legs from the bottom of the oven.
3. Blocking the intake and/or outlet openings can damage the oven.
4. Place the oven as far away from radios and TV as possible. Operation of microwave oven may cause interference to your radio or TV reception.

2. Plug your oven into a standard household outlet. Be sure the voltage and the frequency is the same as the voltage

### **WARNING**

Do not install oven over a range cooktop or other heat-producing appliance. If installed near or over a heat source, the oven could be damaged and the warranty would be void.

# OPERATION

## CONTROL PANEL AND FEATURES

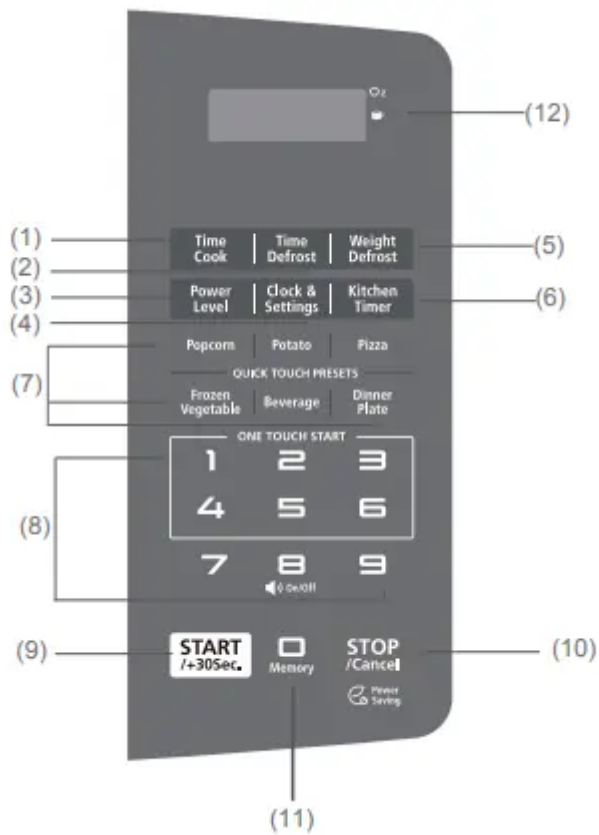

1. Time Cook
2. Time Defrost
3. Power Level
4. Clock and Settings
5. Weight Defrost
6. Kitchen Timer
7. Auto Menu (Popcorn, Potato, Pizza, Frozen Vegetable, Beverage and Dinner Plate)
8. Number Pads
9. START/ +30 SEC
10. Stop/Cancel: Stop/Cancel STOP Cancel Hold 3 sec: Before cooking starts, press to clear all previous settings. During cooking, press once to stop oven; press twice to stop oven and clear all settings.
11. Memory
12. Display

## POWER LEVELS

### Ten power levels are available

Prior to or during cooking, press Power Level and "PL10" will display. Then press number pads to select a different power level.

Level	10	9	8	7	6	5	4	3	2	1
Power	100%	90%	80%	70%	60%	50%	40%	30%	20%	10%
Display	PL10	PL 9	PL 8	PL 7	PL 6	PL 5	PL 4	PL 3	PL 2	PL 1

## CLOCK SETTING

### When the microwave oven is plugged into an outlet, "0:00" will display.

1. Press Clock & Settings once, "00:00" will appear in the display.
2. Press the number pads to enter the current clock time. For example, if the time is now 10:12, press " 1, 0, 1, 2 " in order.
3. Press Clock & Settings to finish clock setting, " : " will flash and the numbers will appear as a clock time in the display.

#### NOTE:

- If the numbers entered are not within the range between 1:00 to 12:59, the setting will not be accepted until valid numbers are entered.
- In the process of setting clock, if the  pad is pressed or if there is no operation within 1 minute, the display will automatically return to the previous clock setting.

## KITCHEN TIMER

1. Press Kitchen Timer once, "00:00" will appear in the display.
2. Press the number pads to enter the time amount. The maximum amount of time that can be entered is 99 minutes, 99 seconds.
3. Press  to confirm setting, and the timer will start to count down.
4. When the time amount elapses, the oven will beep 5 times.

#### Note:

- The Kitchen Timer setting is different from the Clock setting; it is simply a timer.
- During the Kitchen Timer function, no cooking function can be set into operation.
- Kitchen Timer amount cannot be increased by pressing .
- Pressing will cancel the Timer countdown.

## MICROWAVE COOK

1. Press Time Cook , "00:00" will appear in the display.
2. Press number pads to enter the cooking time. The maximum cooking time is 99 minutes, 99 seconds.
3. Press Power Level, PL10 will flash. Press number pads 0 through 9 to select a different power level if desired. See the POWER LEVEL table above.
4. Press  to start cooking. The remaining cooking time will display.



Example : To cook the food with 50% microwave power for 15 minutes.

1. Press Time Cook , "00:00" will display.
2. Press "1, 5, 0, 0" in order for 15:00 to appear in the display.
3. Press Power Level , then press "5" to select 50% microwave power.
4. Press  to start cooking. Buzzer sounds once. The remaining cooking time will display.



### NOTE:

In the process of setting, if the  pad is pressed or if there is no operation within 1 minute, the oven will automatically return to display the clock.

## ONE TOUCH START

1. Instant cooking at 100% power level and 1 to 6 minutes cooking time can be started by pressing number pads 1 to 6. Press  to increase the cooking time by 30 seconds with each press. The maximum cooking time is 99 minutes, 99 seconds.
2. Instant cooking at 100% power level and 30 seconds cooking time can be started by pressing . Each repeated press will increase cooking time by 30 seconds. The maximum cooking time is 99 minutes, 99 seconds.

### NOTE:

- Time can also be added in 30 second increments by pressing  during Microwave Cooking, Time Defrost and Multi-stage Cooking.
- Time cannot be added by pressing  during Weight Defrost and Kitchen Timer functions.





## TIME DEFROST

1. Press Time Defrost , "dEF2" will appear in the display.
2. Press the number pads to input the defrost time.
3. The default microwave power is power level 3. If you want to change the power level, level, press Power Level once, and PL3 will display; then press the number pad for the desired power level.
4. Press  to start defro cooking. And the remaining defrost time will display

## WEIGHT DEFROST FUNCTION

1. Press Weight Defrost once,"dEF1" will display
2. Press number pads to input weight to be defrosted. Input the weight range between 4 to100 Oz. layed.
3. If the weight input is not between 4 to100 Oz, the input will be invalid. A beep will sound and the unit will not work until valid numbers are entered.
4. Press  to start defrosting and the cooking time remaining will be displayed.

## MEMORY FUNCTION

1. Press Memory to program and choose up to three cooking procedures.Each procedure will be indicated by 1, 2 or 3 in the display.
2. Press Memory until your desired procedure number appears in the display. Press  to begin it. A maximum of two cooking stages can be set for each procedure.
3. To program a procedure, follow the steps listed below. Example: Cook food at 80% Power Level for 3 minutes and 20 seconds; save as memory 2.
  1. Press Memory twice; screen displays 2.
  2. Press Time Cook , then press "3" , "2" and "0" in order.
  3. Press Power Level once, then press "8" for "PL 8" to display.
  4. Press  to save the procedure. Oven beeps once. Or press  twice directly to save and start cooking.
  5. To choose the procedure from the memory list, press Memory twice. Screen will display "2". Press  to run procedure.

### NOTE:

Auto Menu cannot be set in Memory function.

## TURN ON/OFF THE BUZZER SOUND

It is default that the buzzer sounds is open. In waiting state, long pressing on number 8 for 3 seconds, it sounds a long beep, turns off the sound. When the sounds turn off, long pressing on 8 for 3 seconds, it sounds a long beep and the sound turn off. All the buttons has no beep when they are pressed, including the ending cooking sounds is turn off too.

**Note:** All models has mute function and energy-saved function. This function can work under lock function too.

## Muti-Stage Cooking

At most 2 stages can be set for cooking. If one stage is Defrost, it will automatically set to be the first stage.

**NOTE:** Auto Menu cannot be set in Multi-stage Cooking

**EXAMPLE:** 80% Power Level for 5 minutes followed by 60% Power Level for 10 minutes; saved as memory 3.

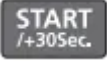
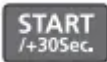
1. Press Memory 3 times; screen displays 3.
2. Press Time Cook, then press "5" , "0" and "0" to set first stage cook time.
3. Press Power Level once, then press "8" to choose 80% first stage cooking power.
4. Press Time Cook again, then press "1", "0", "0" and "0" to set second stage cook time
5. Press Power Level again, then press "6" to choose 60% second stage cooking power.
6. Press  to immediately start multi-stage cooking.
7. To choose the procedure from the memory list, press Memory three times. Screen will display "3"; press  to run procedure.

**NOTE:** If you do not want to save a particular multi-stage program as a procedure, do not press Memory as the first step. Press after programming both stages.

## MAINTENANCE

## TROUBLESHOOTING

Check your problem by using the chart below and try the solutions for each problem.

TROUBLE	Possible Cause	Possible Remedy
Oven will not start	<p>Electrical cord for oven is not plugged in.</p> <p>Door is open.</p> <p>Wrong operation is set</p>	<p>Plug into the outlet.</p> <p>Close the door and try again.</p> <p>Check instructions</p>
Arcing or sparking	<p>Materials to be avoided in microwave oven were used.</p> <p>The oven is operated when empty.</p> <p>Spilled food remains in the cavity</p>	<p>Use microwave-safe cookware only.</p> <p>Do not operate with oven empty.</p> <p>Clean cavity with wet towel.</p>
Unevenly cooked foods	<p>Materials to be avoided in microwave oven were used.</p> <p>Food is not defrosted completely.</p> <p>Cooking time, power level is not suitable.</p> <p>Food is not turned or stirred.</p>	<p>Use microwave-safe cookware only.</p> <p>Completely defrost food. Use correct cooking time, power level.</p> <p>Turn or stir food.</p>
Overcooked foods	<p>Cooking time, power level is not suitable.</p>	<p>Use correct cooking time, power level.</p>
Undercooked foods	<p>Materials to be avoided in microwave oven were used.</p> <p>Food is not defrosted completely.</p> <p>Oven ventilation ports are restricted.</p> <p>Cooking time, power level is not suitable.</p>	<p>Use microwave-safe cookware only.</p> <p>Completely defrost food.</p> <p>Check to see that oven ventilation ports are not restricted.</p> <p>Use correct cooking time, power level</p>



Improper defrosting	<p>Materials to be avoided in microwave oven were used.</p> <p>Cooking time, power level is not suitable.</p> <p>Food is not turned or stirred.</p>	<p>Use microwave-safe cookware only.</p> <p>Use correct cooking time, power level.</p> <p>Turn or stir food</p>
Sensor cooked foods not properly cooked	<p>Cover or lid on food not vented.</p> <p>Door opened before sensor-detected cooking time appears in display</p>	<p>Cover or lid over food must contain vent hole for escaping steam.</p> <p>Do not open door to stir or turn food before sensor-detected cooking time appears in display</p>

**Warning**

This content is compiled from multiple sources and is provided for reference purposes only. It may not be complete or fully applicable to all situations. If you are unable to resolve your issue, please contact the product manufacturer or an authorized service provider for official support.

